













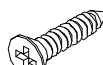



Parts list

Units: mm

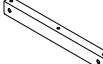
NO	Name	Size	Qty	Note
A	fittings	$\phi 15 \times 10$	16	
B	fittings	M6*35	16	
C	chip	30*8*8	16	
D	anticollision		4	
E	screw	$\phi 3.5 \times 16$	62	
F	hinge		8	
G	screw	$\phi 8 \times 15$	24	
H		M6*20	24	
I	expansion bolt	$\phi 8 \times 50$	1	
J	shelf dowel		8	
K	Hardware		8	
L	cap		16	
M	leg		4	
N	corner fitting	90*50*30	1	
O	corner fitting	275*30*20	2	
P	screw	M6	4	
Q	screw	M6*16	4	
R	screw	M6*10	8	
S	hexagon key	M4	1	

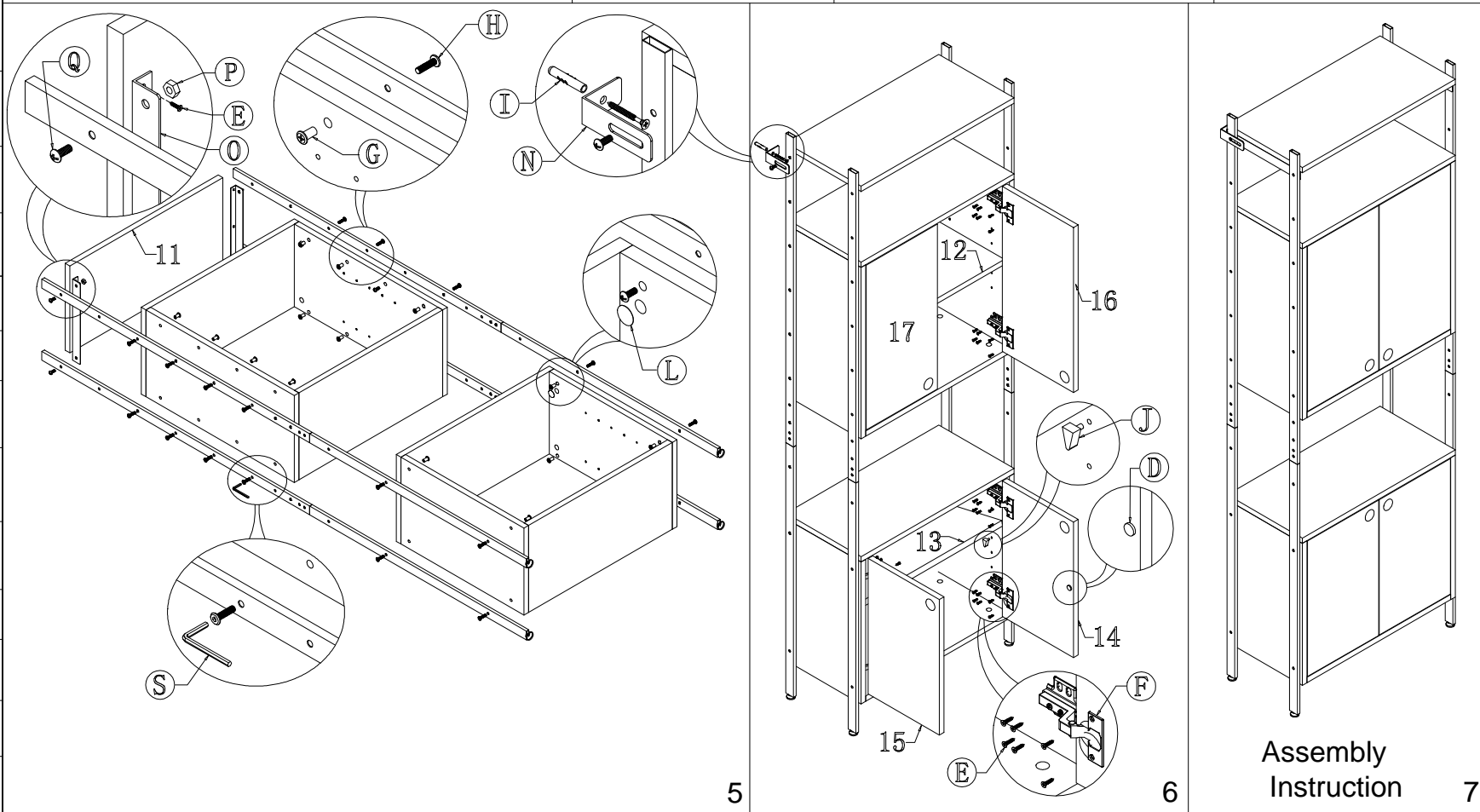
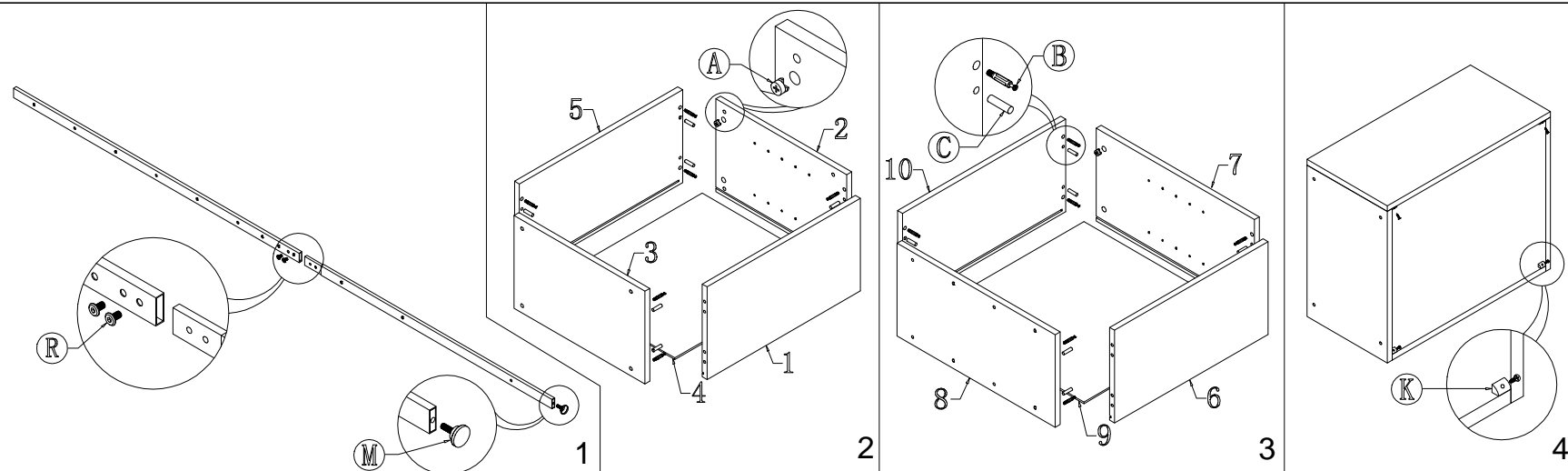

Assembly Instruction

File Cabinet

Model No: RW20-190-2

Size: 600*295*1910