

Preparation Before Installation

1. This shower system needs to be installed to the wall, please make sure check all the size according to the instruction before installation
2. Clean the impurity and sludge in the hose before assembling to avoid leaking
3. Proper water pressure should be between 0.1Mpa-1.0Mpa
4. Turn off the water supply before installation

Installation Manual Tools You Will Need:

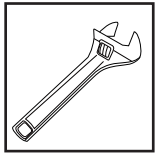

adjustable wrench



wrench hexagon

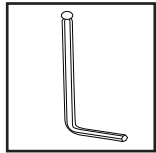

Phillips screwdriver

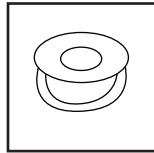

pipe tape

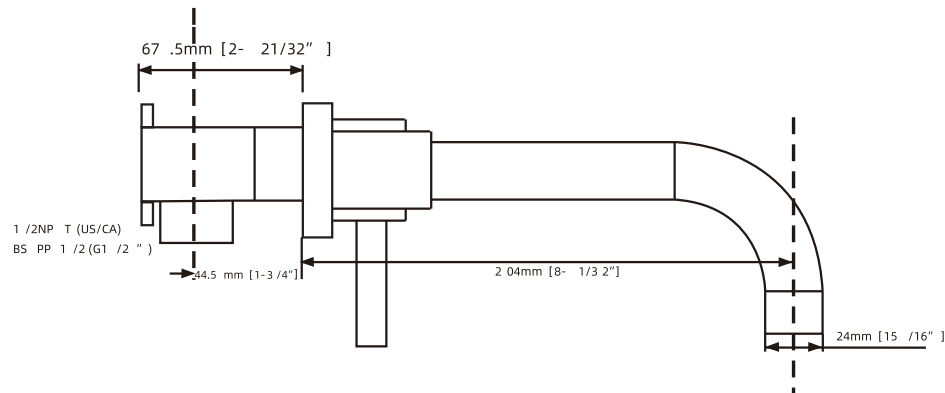
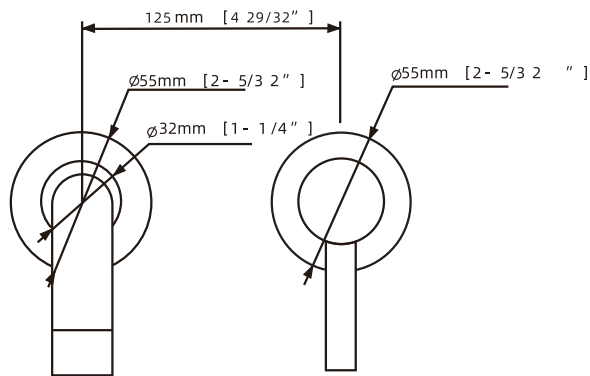

Installation Instructions

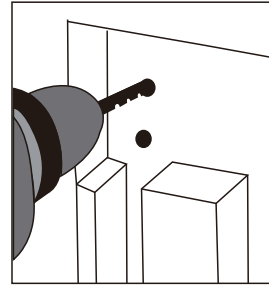

1. Confirm the location of the concealed faucet body, then drill two holes on the wall with percussion drill

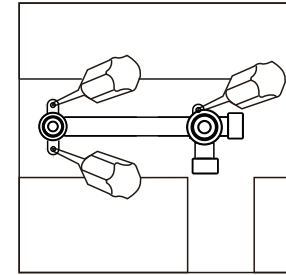

2. Install the concealed faucet body

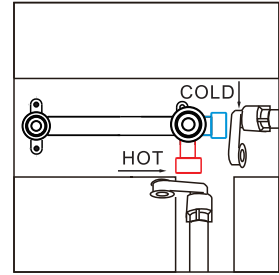

3. Connect hot and cold water inlet pipes

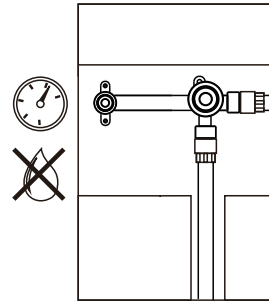

4. Each pipes shall be pressure tested to ensure no leakage

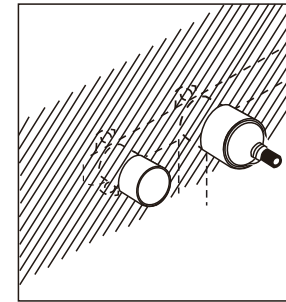

5. Waiting the wall to be tiled

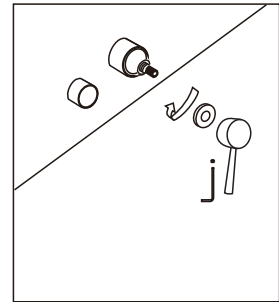

6. Install the handles as the picture shows

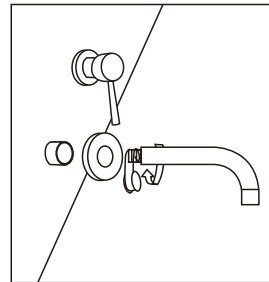

7. Install the outlet pipe well

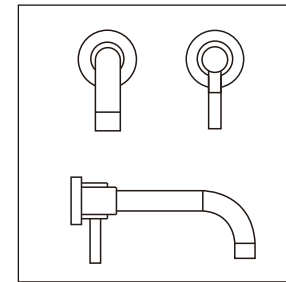

8. Finished

Installation Condition

1. When you open the package, please check the parts according to the standard part list, please contact the distributor if it is breakage.
2. Please make sure the size match to this size drawing.
3. The body is under testing by the factory, please don't dismantle.
4. The left connect to the hot water, the right connect to the cold water.
5. Please make sure to clean the impurity and sludge in the hose before assembly in case of the effect of the inusing function.
6. Please check if there are leakage after assembly.
7. Medium temperature shall not be greater than 90°C.
8. Water pressure: $0.1\text{Mpa} \leq \text{water pressure} \leq 1.0\text{Mpa}$ (including the cold water pressure).
9. When tighten the connecting nut can not be greater than 10nm.
10. Don't over bend the hose and ensure no hose deformation after installation.

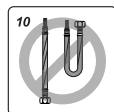
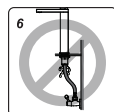
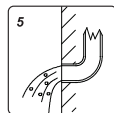
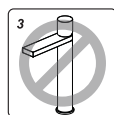

Care and Maintenance

In order to keep the surface of mixer bright, please keep cleaning the mixer regularly.

- Wash mixer with clean water, and dry with soft cotton cloth.
- In order to prevent the worn-out surface, please avoid cleaning with polishing powder and cleaning powder which including the coarse particles.
- Avoid using acidic detergent to contact the surface of mixer as it may cause corrosion.

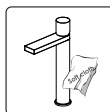

Installation Instructions

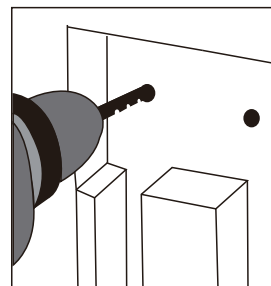

1. Confirm the location of the concealed faucet body, then drill two holes on the wall with percussion drill

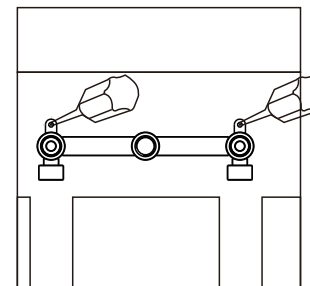

2. Install the concealed faucet body

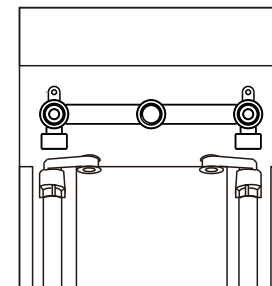

3. Connect hot and cold water inlet pipes

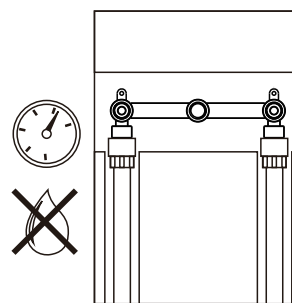

4. Each pipes shall be pressure tested to ensure no leakage

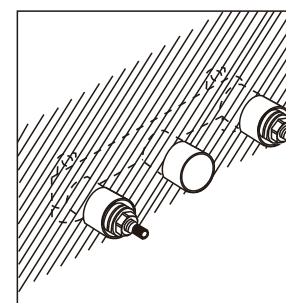

5. Waiting the wall to be tiled

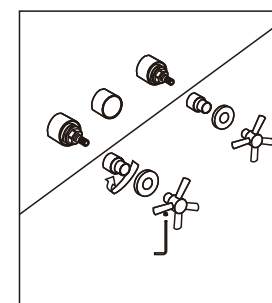

6. Install two handles as the picture shows

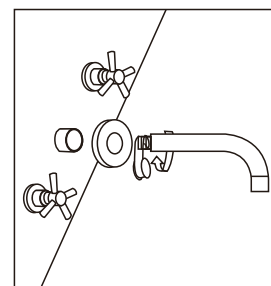

7. Install the outlet pipe well

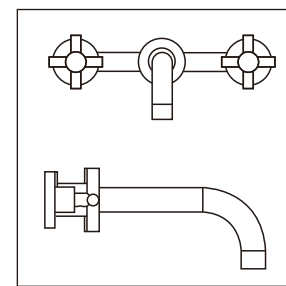

8. Finished