

	Page
• Definition _____	2
• Description _____	3
• Safety _____	4
• Electrical connection _____	5
• Use of the hand control	
- Select your language _____	6
- Locking the hand control setting _____	7
- START/STOP/REVERSE function _____	7
- Quick Start _____	8
- Possible values for each parameter _____	8
- How to adjust the basic parameters of the movement _____	9
- How to modify programs PROGRAM MODE _____	10-12
- Using Programs _____	13
- Reading the values of a program _____	14

	Page
- How to use the WARM UP key _____	15
- How to use the MODULATION key _____	16
- How to use the BYPASS key _____	17
- Session Time _____	18
• Patient Pad kit _____	19
• Setting up the patient _____	20
• Options _____	21
• Product information	
- Maintenance _____	22
- Troubleshooting _____	22
- Cleaning _____	23
- Technical specifications _____	23
- Symbols used _____	24
- Warranty _____	24
- Maintenance sheet _____	25

SAFETY RECOMMENDATIONS

- The physician defines the protocol and ensures that it is correctly implemented (adjustments, session time and frequency of use).
- We recommend that you lock the hand control when you give it to the patient.
- For optimum safety, always give the hand control to the patient before starting the system.
- Explosion hazard: KINETEC Spectra is not designed for use in the presence of flammable anaesthetics.
- Check that the electrical socket is in good condition and is suitable for the splint power supply cord. The latter complies with current standards and has a grounding socket. The plug may be connected to any standard socket. The socket must however have a grounded pin.
To connect the power supply, only use the original cable supplied with the machine.
Check that the cables remain free around the device so that they do not get damaged.

Definition

The KINETEC Spectra is a Knee PASSIVE mobilization device enabling the extension and flexion movement from -10° to 120° .

• Indications

- Knee replacement surgery.
- Fractures (patellar, tibia plateau, femoral,...).
- Arthrolysis
- Hip surgery, including hip replacement, hip pinning, osteotomy,...).
- Ligament repairs.
- Arthroscopic surgery (meniscectomies, patellectomies,...)
- Burns, joints sepsis,...

• Clinical Benefits

- Breaks the cycle of trauma, inflammation and the loss of range of motion.
- Prevents joint stiffness.
- Speeds the recovery of post-operative range of motion.
- Maintains the quality of the joint surface.
- Reduces pain and edema.
- Promotes joint cartilage healing.
- Reduces hospitalization time
- Reduces the need for pain medication.
- Provides immediate post-operative continuous passive motion.
- Digital ROM readout on the patient hand control for positive reinforcement.
- Maintains desired positions for stretching and muscular rest.

• Contraindications

Bone Cancer, Warped joint surfaces, Spastic paralyses, Unstable fractures, Uncontrolled infection.
The machine are not adapted for patients height more 2 m(6'7") or under 1,40m (4'7").

KINETEC Spectra consists of the following components:

- 1 • Lower limb support.
- 2 • Thigh support.
- 3 • Foot support and hand control location for transport.
- 4 • Hand control.
- 5 • Thigh support setting lock.
- 6 • Lower limb support setting lock .
- 7 • Foot support positioning setting lock.
- 8 • Transport handle.
- 9 • ON/OFF switch and fuses.
- 10 • Liquid-crystal display (2 lines of 16 characters).
- 11 • SESSION TIME display key.
- 12 • BYPASS mode key.
- 13 • MODULATION key.
- 14 • WARM UP key.
- 15 • EXTENSION setting key.
- 16 • FLEXION setting key.
- 17 • Increase / decrease keys.
- 18 • START key.
- 19 • STOP key.
- 20 • FORCE key.
- 21 • SPEED key.
- 22 • PAUSE key.
- 23 • TIMER key.
- 24 • PROGRAM access key.

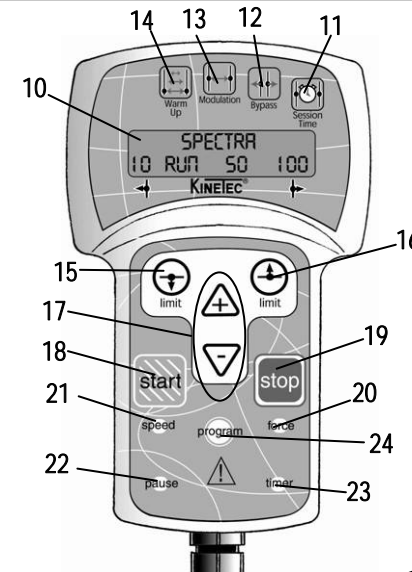
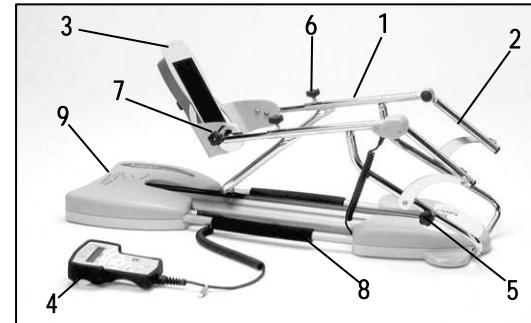

Safety

The physician defines the protocol and ensures that it is correctly implemented (adjustments, session duration and frequency of use).

The patient must know the start/stop/reverse function on the control handle. Hand control must be accessible to patient at all times. (See page 7).

KINETEC Spectra complies with Directive 93/42/CEE.

EXPLOSION HAZARD:
KINETEC Spectra is not designed for use in the presence of flammable anesthetics.

In case of electromagnetic interference with other devices move the device.

KINETEC Spectra is in compliance with standards in force (IEC 601.1.2), electromagnetic compatibility standard for medical devices.

Please, do not touch the moving parts while the unit is running, pinching risk.



With respect to electric shock, fire mechanical and other specified hazards only in accordance with CAN/CSA C22.2 NO. 601.1, medical equipment certified for Canada.

1QD5.

With respect to electric shock, fire and mechanical hazards only in accordance with UL 2601-1

1QD5.



Electrical connection

KINETEC Spectra is a type B class I device.
Before connecting the device to the power supply, check that the mains voltage matches that shown on the identification plate (100-240 V~ 50-60Hz).
Connect the hand control (4)
Connect the power supply cable (25).

IMPORTANT

Check that the electrical socket is in good condition and is suitable for the split power supply cord. The latter complies with current standards and has a grounding socket. The plug may be connected to any standard socket. The socket must however have a grounded pin.
To connect the power supply, only use the original cable supplied with the machine.
Check that the cables remain free around the device so that they do not get damaged.

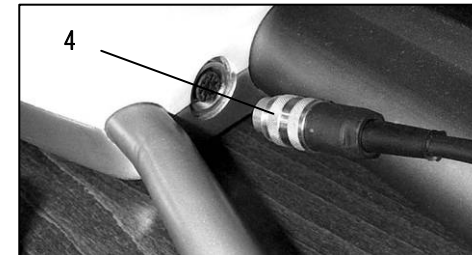
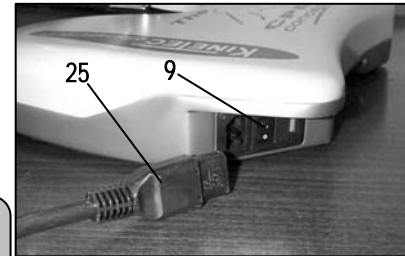

Starting the unit

Switch on (9).



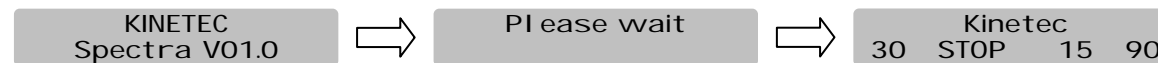

While the unit begins an auto diagnostic, the display shows the following :



Your KINETEC Spectra is ready to be used.

Use of the hand control

Select your language

Beginning	Keys to press	Display	Remarks
Switch the unit ON		<p>KINETEC Spectra V01.0</p> <p>Please wait Kinetec 30 STOP 15 90</p>	Check if the hand control is not blocked (See page 7).
Press the 2 keys in the same time	 	Language: engl ish	The display indicate the language selected.
To change the language	 or 	Language: Engl ish	The English language is selected. English French German Italian Spanish
To validate the new language.		Ok Switch on/off	To exit and confirm the new language, switch OFF and Switch ON the unit.

Locking the hand control setting

The hand control allows the patient to control the machine as appropriate.



Simultaneously press the  and  keys to lock the hand control,

The display reads "LOCK", you can not change the parameters, if you try the display reads "LOCK".

To unlock the hand control, simultaneously press the  and  keys, The display reads "UNLOCK".

We recommend that you lock the hand control when you give it to the patient.

Comment: The hand control is unlocked when you switch the unit ON/OFF.

START/STOP/REVERSE function

As with all KINETEC systems, KINETEC Spectra is equipped with a START/STOP/REVERSE function.

When the unit is running, the display reads RUN

Press the  key of the hand control. The movement stops. The display reads STOP.

Press the  key of the hand control. The movement starts in the opposite direction and the display reads RUN.

Caution:

For optimum safety, always give the hand control to the patient before starting the system.

Use of the hand control

Quick Start













Set up the patient and proceed as below:

Beginning	Keys to press	Display	Remarks
Switch the unit ON			
Start the session with the original parameters of the movement (default setting).			The value change at the speed of the movement.

Possible values for each parameter:











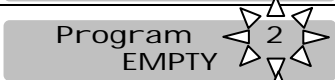

	Possible values	Default setting
• Treatment Mode		Normal
• Extension limit	-10 to 115°	30°
• Flexion limit	-5° to 120°	90°
• Speed	1 to 5 (from 45° to 155° per minute)	2
• Force	1 to 6	6
• Extension pause	0 to 900 seconds (15minutes)	0
• Flexion pause	0 to 900 seconds (15minutes)	0
• Timer	No timer(00H00) to 24H00	0

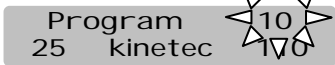
How to adjust the basic parameters of the movement

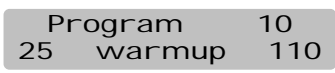

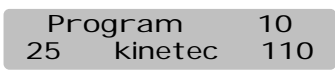

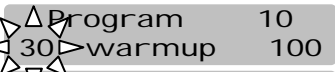









Beginning	Keys to press	Display	Remarks
To stop the unit		KINETEC 30 STOP 15 90	Check if the hand control is not blocked (See page 7).
To display the extension or flexion limit of the movement	 or 	KINETEC 30 Ext 15 90 KINETEC 40 Flex 15 90	The value blinks.
To change the limit if necessary	 Or 	KINETEC 40 Flex 15 110	The new value blinks.
To validate the new value, press another key or wait more than 3 seconds.	  	KINETEC SPEED 2 FORCE _ _ _ _ No timer	While the value blinks press the  or  key to change if necessary.
Or Or to display pause in extension or flexion limit		KINETEC PAUSE HIGH 0 Pause low 0	Successive presses on this key selects the pause at the extension or flexion limit.
To change the pause if necessary	 Or 	KINETEC PAUSE low 15	The new pause value blinks.
To validate the new value press another key or wait more than 3 seconds. The display shows the selected mode.		KINETEC 40 STOP 15 110	The unit is ready to start with the new parameters.

Use of the hand control

How to modify programs PROGRAM MODE

Beginning	Keys to press	Display	Remarks
To switch off the unit			Check if the hand control is not blocked (See page 7).
Press the two keys at the same time and switch the unit ON	 		Welcome text during 3 seconds.
Then			The program number blinks.
To change the program if necessary	 or 		The new program number blinks.
To choose the treatment mode			The display indicates the selected treatment mode, the program number blinks again.
Or			
To display the extension or flexion limit of the movement	 or 	 	The value blinks.

How to modify programs PROGRAM MODE (continued)

Beginning	Keys to press	Display	Remarks
To change the limit of movement if necessary	 or 	Program 30 warmup 	The new value blinks.
To validate the new value, press another key or wait more than 3 seconds	   	Program 10 SPEED: 2 FORCE  No timer Pause low 0	While the value blinks press the  or  key to change if necessary.
To record the program 10		Program 10 Save:+ clear:-	
Then		Program 10 Save Program 11 EMPTY	The program 10 has been recorded and the display indicates the next program so you can change another program.
OR To cancel the program		Program 10 clearing Program 11 EMPTY	The program 10 has been cancelled and the display indicates the next program so you can change another program.
To exit program mode, switch OFF and switch ON the unit.		KINETEC Spectra V01.0	To use the modified program see page 10.





Use of the hand control

Comments:

- When a program has been deleted, the display shows







Program 11
EMPTY

Program table:

Program number	Treatment Mode	Flexion limit	Extension limit	Speed	Force	Flexion Pause	Extension Pause	Timer
	 Warm Up	 limit	 limit	 speed	 force	 pause	 pause	 timer
1								
2								
3								
4								
5								
6								
7								
8								
9								
10								
11								
12								
13								
14								
15								
16								

The KINETEC Spectra allows you to store up to 16 programs, including the type of treatment, ROM, speed, load, pauses and timer.

The original parameter values of the program are empty.
 These values can be modified and recorded at any time (see 'How to enter a program' page 10).







Beginning	Keys to press	Display	Remarks
To stop the unit		KINETEC 40 STOP 15 110	Check if the hand control is not blocked (See page 7).
To access the program mode		PROGRAM 1 70 WARMUP 110	The program number blinks.
To change the program if necessary	 or 	PROGRAM 3 25 warmup 90	The new program number blinks.
To exit and validate the selected program		KINETEC Please wait	The current parameters have been recorded in program 3.
To exit without validation of selected program		KINETEC 40 STOP 15 110	Back to the starting parameters.
Start the unit		warmup 25 run 20 90	The value change at the speed of the movement.

Comments:

- The values shown in the 'Display' column are examples. They actually depend on the stored programs.
- The current movement parameters can be changed while using that program but no data will be stored in the original program. See the programming mode (p 10) to modify programs.

Use of the hand control

Reading the values of a program: example SPEED

Beginning	Keys to press	Display	Remarks
To stop the unit		KINETEC 40 STOP 15 110	Check if the hand control is not blocked (See page 7).
To access the program mode		Program 1 70 WARMUP 110	The program number blinks.
To change the program if necessary	 or 	PROGRAM 3 25 warmup 110	To change the program if necessary.
To read the speed value		PROGRAM 3 Speed 5	Displays the speed value.
After 5 seconds or after pressing on another key		PROGRAM 3 70 WARMUP 110	
To exit and validate the selected program		KINETEC 40 STOP 15 110	The current parameters have been recorded in program 3.
Start the unit		KINETEC 40 run 15 110	The value change at the speed of the movement.

Comments:

- The values shown in the 'Display' column are examples. They actually depend on the stored programs.
- The current movement parameters can be changed while using that program but no data will be stored in the original program. See the programming mode (p 10) to modify programs.



How to use the WARM UP key

Beginning	Keys to press	Display	Remarks
To stop the unit		KINETEC 40 STOP 15 110	Check if the hand control is not blocked (See page 7).
To select the Warm Up mode		PLEASE WAIT WARM UP 30 STOP 15 90	The display shows the default settings (see page 8). To change the movement value if necessary see page 9.
Start the movement		WARM UP 15 RUN 15 110	The value change at the speed of the movement.

Warm Up rules:

The Kinetec Spectra starts at 70% of the full ROM, increasing 5% of the range every other cycle until the pre-set ROM is reached.

Comments:

- The parameters modification should always be done while the unit is stopped.
- Pauses and By-Pass mode are not available during warm up cycles.
- The Warm Up cycles are only working when the movement is firstly run.
- To start new Warm Up sessions press twice the « Warm Up » key.
- The calculation mode used enables reaching the pre-set ROM in approximately seven full cycles.

Example:

For a Warm Up treatment with a pre-set ROM from 0° to 100°. The first cycle starts from 15° to 85° to 15° and increase 5% each cycle.

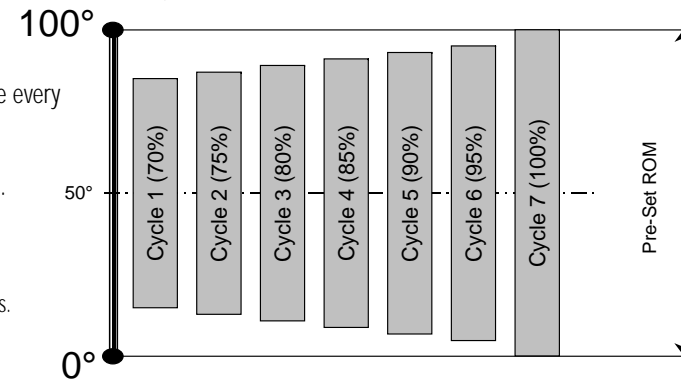













Use of the hand control



How to define the patient tolerance • At the start of a session

This function, MODULATION Mode is a way to set within the tolerance of a patient at the beginning of a session.

Set up the patient and proceed as below:







Beginning	Keys to press	Display	Remarks
Switch the unit ON		<p>KINETEC Spectra V01.0</p> <p>Please wait Kinetec 30 STOP 15 90</p> <p>Or</p> <p>WARMUP 30 STOP 15 90</p>	<p>Check if the hand control is not blocked (See page 7).</p> <p>If the Warm Up mode is selected, switch OFF this mode by pressing on the key </p>
To select the MODULATION Mode		<p>MODUL.: use + or - 30 STOP 15 90</p>	The display indicates the keys to be used to drive the machine; this message is displayed 3 seconds.
To select the pain level ( for flexion,  for extension)	 Or  Continuous press	<p>MODUL.: use + or - 30manual 50 90</p>	The unit is moving to the selected way. It is waiting for you to select new limits.
To set the pain level when reached, immediately press	 or  limit limit	<p>MODUL.: use + or - 30manual 50 50</p>	The new limit of the movement is recorded
To start the session with the new movement limits		<p>KINETEC  30 run  45  50</p>	The angle display changes with current movement.



How to define the patient tolerance • During the session

This function, The BY-PASS MODE is a way to address the pain threshold of a patient during a session.

IMPORTANT: Can be used only when the machine RUN.

Beginning	Keys to press	Display	Remarks
The unit is running		Kinetec 30 RUN 15 90 Or WARMUP 30 RUN 15 90	Check if the hand control is not blocked (See page 7).
To select the BYPASS mode		PYPASS: use + or - 30 RUN 15 90	The display indicates the keys used to run the machine. This message is displayed 3 seconds.
To select the NEW pain level	 Or  Continuous press	BYPASS: use + or - 30bypass 100 90	The unit is moving to the selected way. It is waiting for you to select new limits.
To set the NEW pain level when reached, immediately press	 or  limit limit	bypass.: use + or - 30manual 50 50	The new limit of the movement is recorded.
Continue the session with the new movement limits.		WARMUP 30 run 45 50	The angle display changes with current movement.

Use of the hand control

Session Time



This function shows the running time (in minutes) of the session (motor functioning).

- It directly accessible by the key , the display shows

TIME	02h25
30 STOP	15 90

This counter is reset each time the unit is switched ON.

Use of the Kinetec Patient Pad Kit

The KINETEC Patient Pad Kit is designed for rapid fitting, optimal hygiene and maximum patient comfort.

- For using and positioning the straps, please refer to here under. Make sure that the self-adhesive parts (26) are visible.
- Place the sponge side next to the skin.

**FOR OPTIMAL HYGIENE, A NEW SET OF PADS SHOULD BE USED FOR EACH PATIENT.
Each cover is provided with a label to record the patient's name**

CLEANING:

- Sterilization of the pads (if necessary): Sterilized at 134 °C during 18 minutes.
- Disinfecting of the pads: Washing at 30°C with use of a disinfecting solution during the rising cycle.

Example of product that can be used: Solution " Baclinge" at 0.125 % or "Souplanios" at 0,125% from ANIOS Laboratory.

A complete list of distributors in your country is available on request.

The KINETEC Spectra is delivered with a complete set. Components:

- 4 straps
- 1 foot support
- 1 cover

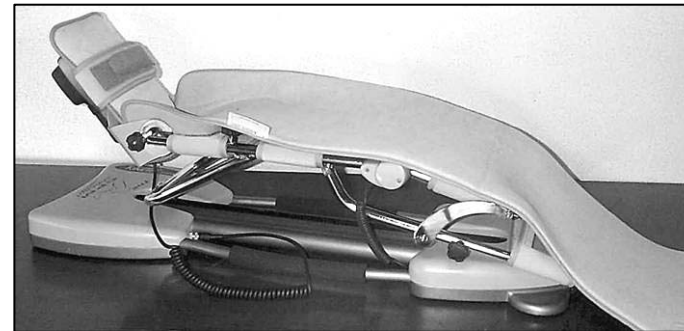
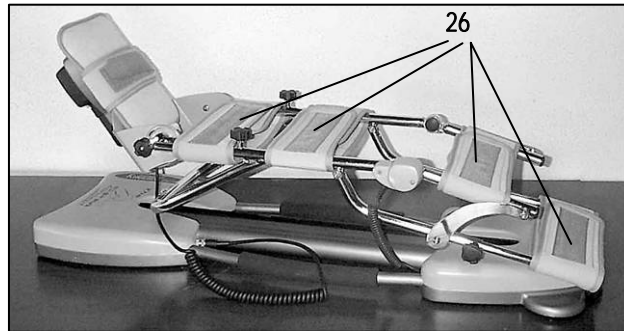

Setting up the patient

Place the KINETEC Spectra machine in a position that will be comfortable for the patient.

- Measure in cm or inches the length of the patient's femur (L); adjust the thigh support to this measurement using knobs (5)
- To install the patient on the KINETEC Spectra machine.
- Push the foot plate (3) up to the patient and tighten the knobs (6).
- Adjust the plantar flexion (40°) or the dorsal flexion (30°) of the foot, with the knobs (7).
- Adjust the internal (30°) or external (30°) flexion of the foot, with the knob (27).

IMPORTANT

Adjust the axis of the patient's hip (28) with the axis rotation (29) of the KINETEC Spectra machine, and the axis of the patient's knee (30) with the axis rotation (31) of the KINETEC Spectra machine.

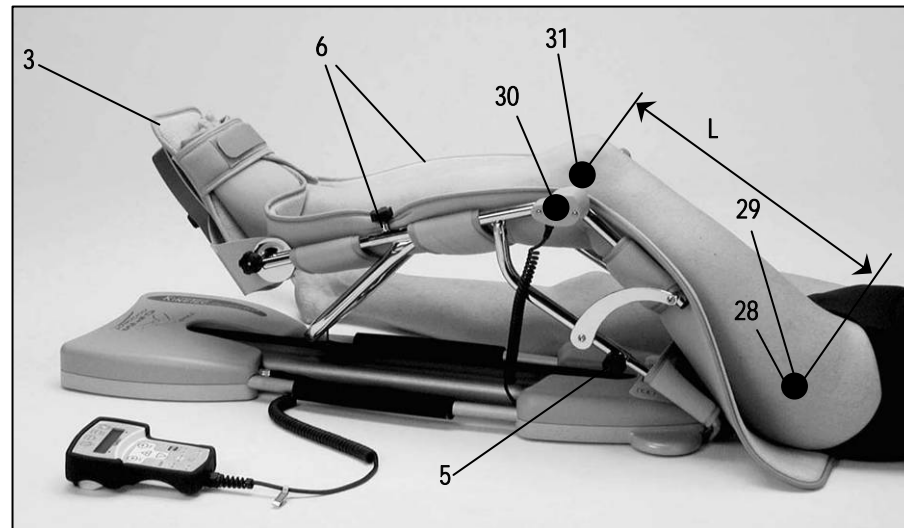
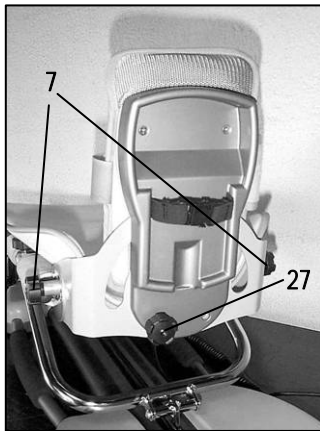

Options



Cart



Product information

Maintenance

After 2,000 hours of operation, KINETEC Spectra requires a few lubrication and maintenance operations (lubrication of the joints, pointer stops and ball screws). The need for maintenance is indicated by display of the message SERV. MOTOR when the system is switched on. Despite that warning, you can continue to use your KINETEC Spectra by pressing START, but you should contact your nearest KINETEC technician to have the maintenance operations conducted as soon as possible.

- A motor running time counter is available. Simultaneously press keys  and , the displays shows

RESET TIME 924H
Reset: Limit Low

this counter can be resetting by pressing the key .

Troubleshooting

A spare parts list and technical catalog are available to you on request from your KINETEC distributor.

If, after connecting the power supply cable to the power supply and switching on KINETEC Spectra:

- The display does not indicate any information:
 - Check that the electrical socket is live using another device.
 - Replace the fuse(s) (32) of the connector with fuses of the same type and calibre:
2 fuses T 750 mA 250V (6.3 x 32) (KINETEC order: 4610007434).
 - If the display still does not indicate any information, contact your nearest KINETEC technician.
- Your KINETEC Spectra does not work and the display indicates 50 STOP 25 115,
Press START again.
Your KINETEC Spectra still does not function: Contact your nearest KINETEC technician.
- Your KINETEC Spectra does not function and the display indicates:
 - ANGULAR POSI.: angle measurement function failure,
 - or NO MOVEMENT: no movement,
 - or BAD WAY: motor rotation failure,
 - or LOAD MAXI: abnormal consumption,
 - or POWER SUPPLY: power failure;Contact your nearest KINETEC technician if the same message is displayed after having switched the device off, then on, and started it by pressing START.

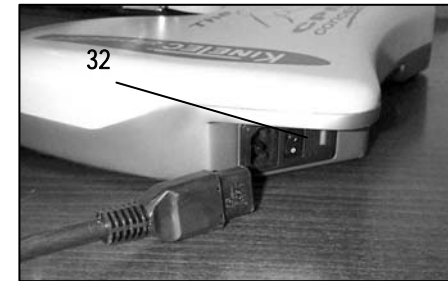

Product information

Cleaning

Before conducting any cleaning operation, SWITCH the unit OFF and disconnect the power supply.
Use a DISINFECTANT (PROPANOL/ISOPROPANOL or ALDEHYDE-based solution). Spray the disinfectant on the SURFACES (plastic shells and metal components).
In order to ensure optimal hygiene, you are advised to clean the covers for each new patient. All the consumables enable hazard-free disposal.

Elimination and recycling

- a • Packing: Packing must be separated from the components plastic and paper/cardboard and given to the specific sites from recycling.
- b • KINETEC PATIENT PAD KIT: To clean with a product of disinfection then to give it to the specific sites of recycling.
- c • Spectra unit: It contains electronic components, cables, aluminum, steel and plastic parts. When the splint is not operational any more, to dismount and separate in groups from materials and to give them to correct unit of recycling or to turn over the machine to Kinetec for destruction.

Technical specifications

Product:

Weight:	12Kg (24 pounds)
Splint dimensions:	94cm (37 inches) x 33cm (13 inches) x 33cm (13 inches)
Angular limits:	-10° to 120°
Speed:	from 45 to 155° per minute
Patient height:	full leg: 71 to 106 cm (28 to 41.7 inches) Tibia: 38 to 60 cm (15 to 23.6 inches) Femur: 33 to 46 cm (13 to 18 inches)

Electricity:







Power supply: 100-240 V~
Frequency: 50-60 Hz
Power consumption: 50 VA
Device of type B class I
IP 20.
Fuse T 750mA 250V 6.3x32mm (KINETEC order: 4610007434)







Environment







- Storage/transport conditions:
 - Temperature: -40 to 70°C / -40 to 160°F
 - Relative humidity: up to 90%
- Operating conditions:
 - Room temperature: 10 to 40°C / 50 to 105°F
 - Relative humidity: up to 80%

Product information

Symbols used

	TYPE B device (protection against electric shocks)
	Caution (consult the accompanying documents)
	STOP (power off)
	ON (power on)
	Start movement
	Stop movement
	Program access

	Speed
	Timer
	Force
	Pause
	Increase
	Decrease
	Extension limit

	Flexion limit
	Warm Up
	Modulation
	Bypass
	Session time
	Alternative current
	Contains electric and electronic components; not to throw in the dustbins of household refuse

Warranty

The KINETEC warranty is strictly limited to the replacement free of charge or repair in the plant of the component or components found to be defective.

KINETEC guarantees its joint passive mobilization systems for 2 years against all defects of manufacture from the date of purchase by the consumer.

KINETEC is the only organization able to assess the application of the warranty to its systems.

The warranty will be considered null and void if the device has been used abnormally or under conditions of use other than those indicated in the user's manual.

The warranty will also be considered null and void in the event of deterioration or an accident due to negligence, inappropriate surveillance or inappropriate maintenance, or due to transformation of the equipment or an attempt to repair the equipment.

Serial number: _____
Purchasing date: _____

Date: _____	Operations done: _____
Technician: _____	_____
Running time (see page 22): _____	_____
Exchange parts: _____	_____
_____	_____

Date: _____	Operations done: _____
Technician: _____	_____
Running hours (see page 22): _____	_____
Exchange parts: _____	_____
_____	_____