

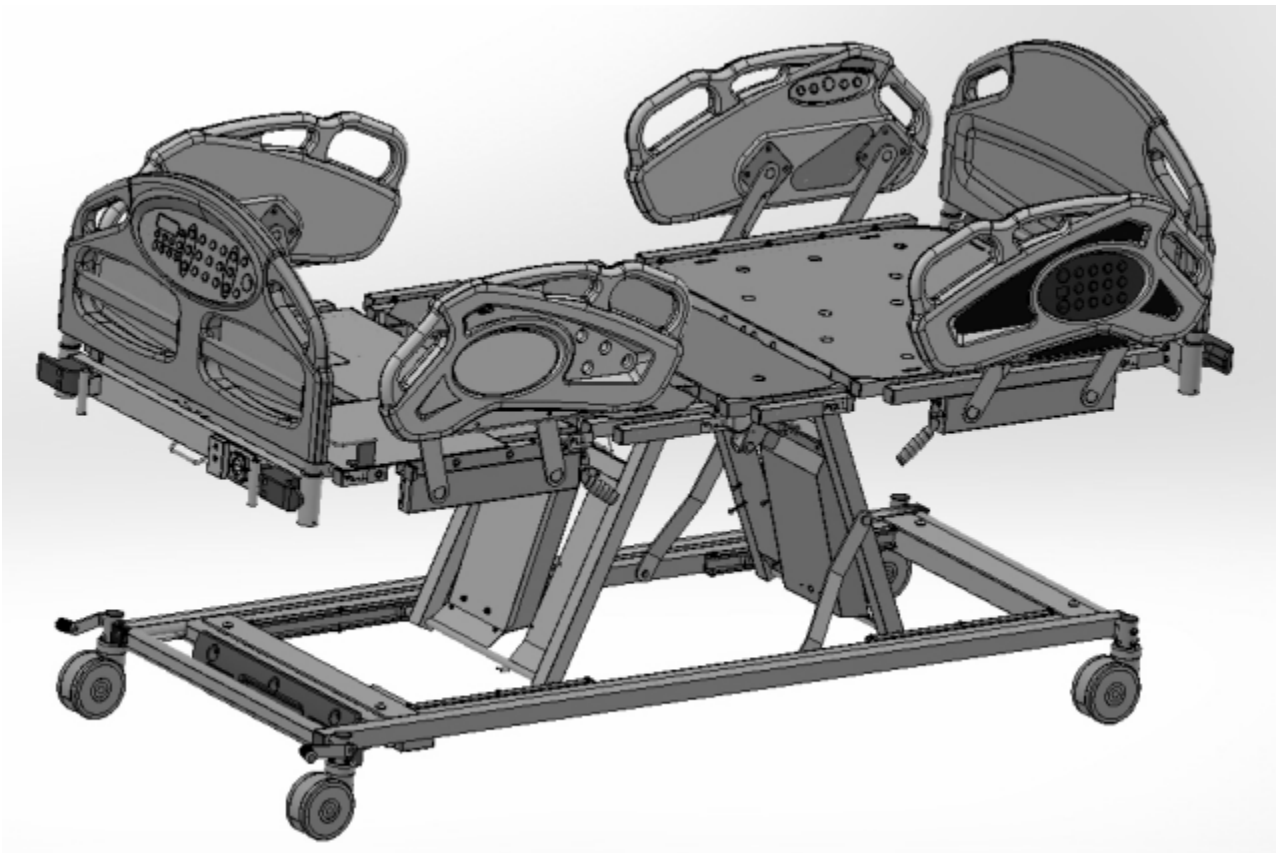



Prius – Ai1 User Manual





'To avoid possible injury during use, read this User Manual in its entirety'

Important Precautions

 **Warning: Possible Injury Or Death.** This product is intended for use as an adjustable mattress support platform with adjustable height for patient and caregiver convenience. Use of this product in a manner for which it was not designed could potentially result in injury or death.

 **Warning: Possible Injury.** The intended users of this product are healthcare employees and patients (use of patient controls only) need to be an adult who are at least fifteen years in age and have the physical strength and cognitive skills to operate the product. Follow facility safety protocols if an intended user does not have the physical strength or cognitive skills to operate and control the product safely.

 **Warning: Possible Injury.** Check the area under and near bed perimeter is free of people and obstructions before operating. Failure to do so could result in injury.

 **Warning: Possible Injury.** Keep bed in lowest position except when providing care (bathing, clothing changes, etc.). Bed should be at lowest convenient height for entry or exit. Failure to do so could result in injury.

 **Warning: Possible Injury Or Death.** Floor and caster locks must be locked prior to any patient transfer or patient use of the bed. Failure to do so could result in injury or death.

 **Warning: Possible Injury Or Death.** Patients with reduced mental acuity should not be allowed access to pendant for risk of cord entanglement. Unsupervised use of pendant could result in injury or death.

 **Warning: Possible Injury Or Death.** Bed safe working load is 600 pounds. The safe working load includes weight counting patient, mattress, bedding and any other equipment. Do not exceed 600-pound safe working load. Exceeding the safe working load could result in property damage, injury or death.

 **Warning: Possible Injury.** Do not use the product outside the recommended patient height, width, and weight ranges. The general physical description of an adult is a person who is greater or equal to 40kg in weight, 146cm in height, and with BMI greater or equal to 17.

 **Warning: Possible Fire Hazard.** Use nasal mask or ½ bed tent oxygen administering equipment. Oxygen tent should not extend below mattress support platform. Pendant should not be placed in an oxygen-enriched environment such as an oxygen tent. Use of electrical circuits in an oxygen-enriched environment could result in a fire hazard.

 **Warning: Possible Shock Hazard.** Always unplug power cords from wall outlet before

performing any maintenance, cleaning, or service to the bed. Failure to do so could result in injury or death. **Note:** In case of unexpected movement, disconnect battery and unplug bed from any outlet.

 **Warning: Possible Shock Hazard.** Injury may result from improper routing of the power cord.

Always follow the proper factory-installed routing configuration. Failure to do so could result in injury or death. Do not position the device where access to mains connection cannot be disconnected.

 **Warning: Possible Injury Or Death.** Use a mattress that is properly sized to fit mattress bed deck, which will remain centered on mattress bed deck relative to State and Federal guidelines. Length and width should match mattress bed deck. Use of an improperly fitted mattress could result in injury or death.

 **Warning: Possible Injury Or Death.** If a patient's mental or physical condition could lead to patient entrapment, the mattress bed deck should be left in the flat and lowest position when unattended. Failure to do so could result in injury or death.

 **Warning: Possible Injury or Death.** An optimal bed system assessment should be conducted on each patient by a qualified clinician or medical provider to ensure maximum safety of the patient. The assessment should be conducted within the context of, and in compliance with, the state and federal guidelines related to the use of restraints and bed system entrapment guidance, including the Clinical Guidance for the Assessment and Implementation of Side Rails published by the Hospital Bed Safety Workgroup of the U.S. Food and Drug Administration. Further information can be obtained at the following web address:

<http://www.fda.gov/MedicalDevices/ProductsandMedicalProcedures/GeneralHospitalDevicesandSupplies/HospitalBeds/default.htm>.

 **Warning: Possible Injury Or Death.** Use a properly sized mattress in order to minimize the gap between the side of mattress and Side Rails/Assist Devices. This gap must be small enough to prevent patient from getting his/her head or neck caught in this location. Make sure that raising or lowering bed, or contouring the mattress support platform, does not create any hazardous gaps. Excessive gaps may result in injury or death.

 **Warning: Possible Injury Or Death.** Verify all Side Rails/Assist Devices are locked in place before use. Failure to lock assist devices may result in injury or death.

 **Warning: Possible Injury Or Death.** Do not use any replacement parts not manufactured, marketed, or provided by Prius Healthcare USA. Use of unapproved replacement parts may result in injury or death.

Warning: Possible Injury Or Death. If using accessories not manufactured, marketed, or provided

by Prius Healthcare USA, consult with the manufacturer for compatibility and limitations prior to use. Failure to do so may result in injury or death.

 **Warning: Possible Shock Hazard.** Bed power cord has a hospital-grade, 3-prong grounded plug. Grounding reliability can only be achieved when equipment is connected to an equivalent receptacle marked “hospital-grade”. If external grounding conductor is in doubt, operate bed from backup battery. Failure to do so could result in injury.

 **Warning: Possible Equipment Damage Or Injury To Staff Members.** Service and repair must only be performed by qualified, authorized Prius Healthcare USA.

 **Warning: Explosion Hazard.** Do not use in the presence of flammable anesthetics, gas or vapors. Failure to heed this warning could result in equipment damage, injury or death.

 **Caution:** Stay clear of underneath the bed when adjusting or moving the bed.

 **Caution:** Mattress bed deck is not grounded, nor does it have a potential equalization connection point. To prevent injury to patient connected to intravascular or intercardial medical equipment, alternate measure must be implemented to equalize the potential between mattress support platform and medical equipment.

 **Warning:** To reduce the risk of injury, ensure the mattress support platform is horizontal and in the lowest position with the side rails fully raised and locked when moving the bed with a patient in it. For best maneuverability, push the bed from the head end. To avoid injury to the patient and/or user, do not attempt to move the bed laterally with the steer engaged. The wheel cannot swivel.

 **Warning:** The bed should not be used adjacent to, or stacked with, other equipment due to the risk of electronic interference. If adjacent or stacked use is necessary, the bed should be observed to verify normal operation in the configuration in which it will be used.

 **Warning:** Using non-approved cables and accessories may negatively affect the EMC performance.

 **Warning:** Mobile RF communication equipment can affect Medical Electrical Equipment.

 **Warning:** Medical electrical equipment needs special precautions regarding EMC and needs to be installed and put into service according to the EMC information provided in this manual.

 **Warning:** External equipment intended for connection to signal inputs, signal outputs or other

connectors shall comply with the relevant product standard. In addition, all such combinations – Medical Electrical Systems – shall comply with the safety requirements stated in the general standard IEC 60601-1. Any equipment not complying with the leakage current requirements in IEC 60601-1 shall be kept outside the patient environment i.e. at least 1.5 m from the patient support or shall be supplied via a separation transformer to reduce the leakage currents.

Any person who connects external equipment to signal inputs, signal outputs or other connectors has formed a Medical Electrical System and is therefore responsible for the system to comply with the requirements. If in doubt, contact qualified medical technician or your local representative.

 **Caution:** Particular precaution must be considered during exposure to strong emission source such as High Frequency surgical equipment and similar devices. Do not route High Frequency cables on or near device. If in doubt, contact a qualified technician.

 **Caution:** To avoid damage to the side rail mechanisms, do not move the bed using the side rails.

 **Caution:** Unplug bed from power source, wrap Power Cord around cord storage hooks on bed frame below Head Panel and hang Pendant from Head Panel before transporting. Failure to do so could result in Power Cord, pendant cord, or bed damage, thereby creating a potential hazard.

 **Caution:** Drainage bag loops are not intended for use as tie downs.

This device has no known contraindications.

The Prius Healthcare USA Ai1 Premium bed is intended for use within institutional healthcare environments 3 (ie: rehabilitation care). Please check your local regulations and guidelines for compliance.

When assessing the risk for entrapment, you need to consider your bed, mattress, Head/Foot Panels, Side Rails/ Assist Device and other accessories, as a system. The patient's physical and mental condition must be evaluated to initiate an appropriate individual care plan to address entrapment risk.

Save These Instructions

Table of Contents

Bed System Entrapment Information.....	1
Features and Specifications.....	2
Bed Operation	4
Bed Controls.....	5
Manual Bed Controls.....	14
Patient Pendant Operation.....	18
Additional Features.....	19
Cleaning Procedures.....	21
Preventative Maintenance.....	22
Troubleshooting.....	24
EMC Related Notifications.....	26
Expected Service Life.....	30
Warranty.....	30









Bed System Entrapment Information

Although essential in the practice of long-term care, bedside assists, are subject of regulatory review and evolution in design and use.

The U.S. Food and Drug Administration (FDA) has addressed the potential danger of entrapment with new safety guidelines for medical beds. These guidelines recommend dimensional limits for critical gaps and spaces between bed system components.

Entrapment zones involve the relationship of components often directly assembled by the healthcare facility rather than the manufacturer. Therefore, compliance is the responsibility of the facility.

I.D. Label Symbol Definition

	<p>Warning</p> <p>NOTE Background color: yellow Triangular edge : black Symbol : black</p>		<p>Refer To Instruction Manual / Booklet</p> <p>NOTE Background color: blue Symbol : white</p>
	<p>Safe Working Load</p>		<p>Type B Applied Parts, user controls, mattress, support platform</p>
	<p>Maximum PATIENT Weight</p>		<p>Waste Disposal</p>
	<p>Protective Earth (ground)</p>		<p>Refer to Accompanying Documents</p>
	<p>Warning</p>		

Features and Specifications

Standard Features

- Fully adjustable mattress bed deck with independent back and knee movement, up/down adjustments including AdvancedCare positioning for Trendelenburg and Reverse Trendelenburg, Auto Contour, Chair and Gravity Assist positioning
- 35" wide mattress support platform sections that can expand to 42" and 48" wide
- Mattress bed deck expands from 80" to 84" and 88" length
- Height adjustable from 10" to 31"
- Side Rails on head and foot sections lower for easy patient access
- Pendant control for all bed functions
- Staff Control with lockouts located in the foot panel and side rails
- Head End Side Rails have back section angle indicators
- Central brake and steer lock
- Emergency manual and electronic CPR release for mattress bed deck
- Emergency battery backup system
- Removable pan-style mattress bed deck for ease of maintenance and cleaning
- Drainage bag loops
- Under bed light
- Integrated USB port
- Integrated IV pole holder (1/2")
- Integrated pump holder (in the foot panel)
- Safety Stop protection for obstructions
- Auxiliary power outlet on select models

Electrical Specifications

Power: 120 VAC North America

Frequency: 60 Hz North America

Current Rating: 5.0 Amps North America

Classification: Class I, Type B

Mode of Operation: 10% Maximum Duty Cycle, 2 minutes on/18 minutes off

Circuit Protection: Auto Reset Current Sensor

Patient Touch Current Leakage: <100 microamps

Aux. Outlet: 10 Amps

Note: Actuators operate on a 24V DC system

Accessories And Options

- Integrated bed exit alarm
- Integrated patient weigh scale for weight monitoring
- Nurse call integration
- Safety Stop protection for obstructions
- Trapeze/Patient Helper Bar

Environmental Conditions

Operating Conditions:

Ambient Temperature: +50°F to +104°F
 Relative Humidity: 30% to 75% Non-Condensing
 Atmospheric Pressure: 700 hPa to 1060 hPa
 Protected Against Splashing Water: IPX4

Storage and Shipping Conditions:

Ambient Temperature: -40°F to +158°F Relative
 Humidity: 15% to 93% Non-Condensing
 Atmospheric Pressure: 500 hPa to 1060 hPa

Mechanical Specifications

Description: Dimensions:

Model No..... Ai1-Premium
 Overall Dimensions.....89.7"L x 39.7"W x 10"H
 Sleep Surface.....84"L x 35.0"W x 7.0"H
 Weight..... 466 lbs.
 Maximum Back Angle.....70° to horizontal
 Maximum Knee Angle35° to horizontal
 Trendelenburg/Reverse Trendelenburg..... 14°
 Minimum Height Mattress Support Surface
 Base Bed.....10.00"
 Maximum Height Mattress Support Surface
 Base Bed31.5"
 Caster Diameter.....5"
 Safe Working Load..... 600 lbs.
 Maximum Patient Weight..... 550 lbs.
 Ingress Protection Rating.....IPX4
 Expected Service Life.....10 years

Recommended Mattress Size

Length \ Width	80 inch	84 inch (1 st exp.)	88 inch (2 nd exp.)
35 inch	35" x 80"	35" x 84"	35" x 88"
42 inch (1 st exp.)	42" x 80"	42" x 84"	42" x 88"
48 inch (2 nd exp.)	48" x 80"	48" x 84"	48" x 88"

Suggested mattress height: 6"

Bed Operation

Quick Start Set Up

1. Plug bed into electrical wall outlet that is grounded hospital-grade

2. Place all linens and accessories on bed
3. Zero the bed scale (See scale section)
4. Lower bed to appropriate transfer height
5. Lock casters by engaging the caster brake lever at the foot end
6. Bed is now ready for patient use

Initial Start Up

After positioning bed, always engage caster brake lever.

 **Warning:** It is important to **always engage the caster brake lever** to prevent unintended bed movement.

Emergency Manual Mattress Bed Deck Release (CPR Release)

1. The mattress bed deck can quickly be leveled using the pendant or staff control.
2. To return mattress deck to a level position in case of power and battery backup failure, pull the CPR lever to the side of the bed (Figure 3). Hold CPR handle until mattress bed deck lowers to desired position. Release handle if you need to stop descent. Note: A total loss of all power will freeze the movements of all other bed sections and functions. Patient removal is recommended.

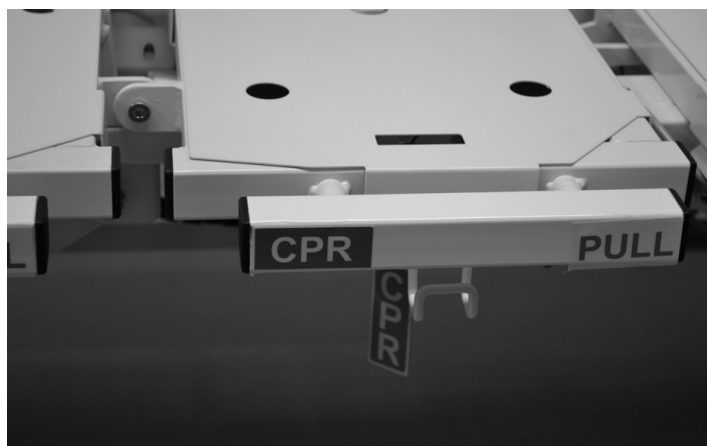



Figure 3

 **Warning:** The head section will lower quickly – keep hands clear to avoid injury.

Bed Controls

Staff Control Panel Operation

Warning: Possible Injury Or Death. Use Staff Control at the foot panel or in the side rails to deactivate bed when patient movement or inadvertent activation of bed functions by patient or staff

member could result in personal injury.

The Staff Control panel located at the foot panel and outer head end side rails allows the user to operate from different points on the bed.

Caregivers can use the control panels to adjust all mattress bed deck sections to desired positions. The caregiver can also individually lock out all functions on both the Pendant and Staff Control.

1. To lock out a function, press the applicable "Lock" graphic underneath the function. The LED will illuminate which indicates that function is locked out.
2. To unlock function, press the appropriate "Lock" underneath the function to unlock. The LED is no longer illuminated, signaling that function is now operable.

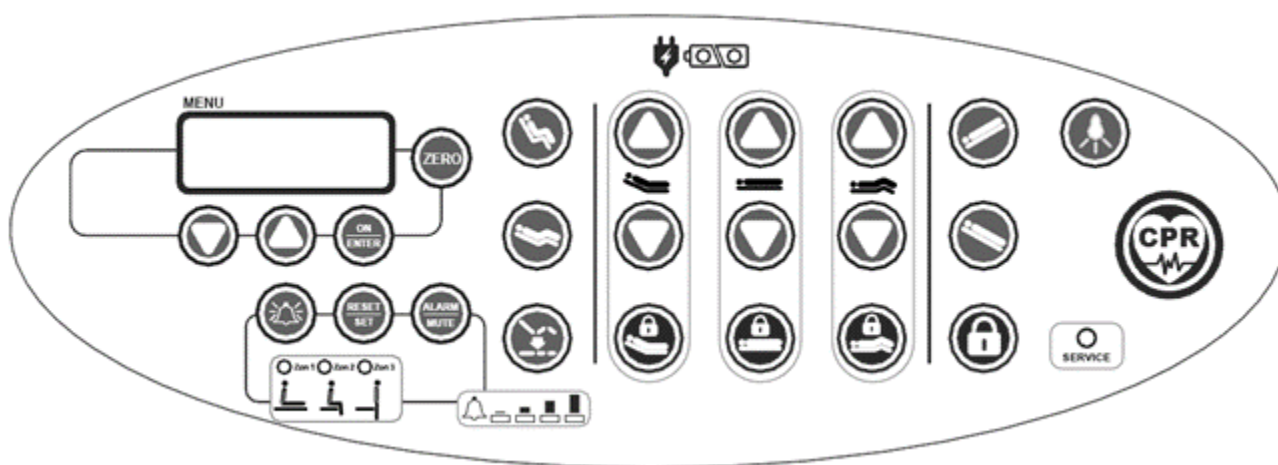

Foot panel control (premium version)

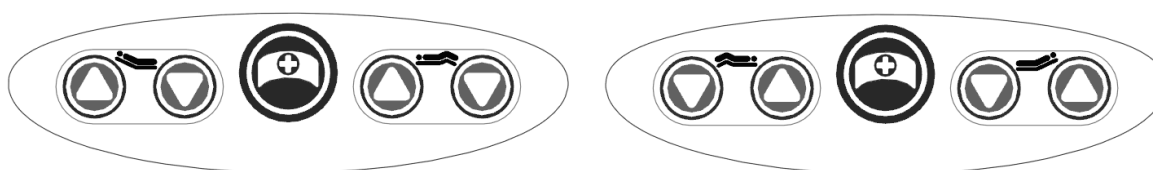

Side Rail patient control (premium version)

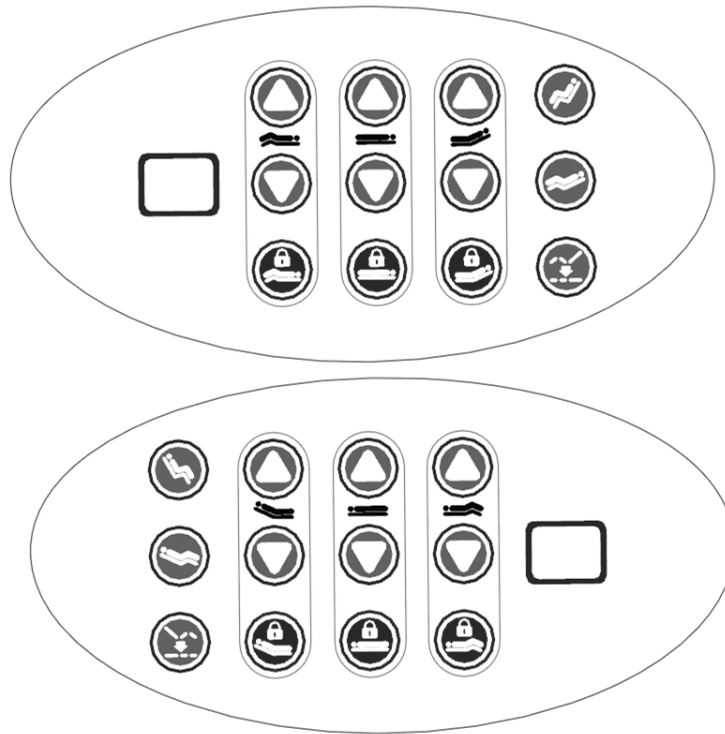

Side Rail Staff Control (premium version)

Head Angle Adjustment



Function: The head angle adjustment buttons allow the head section to move up or down.

Operation: Press and hold to move the head section to the desired angle. The degree of head section angle will be displayed in the control panel window located on the head end caregiver side rails. The angle can be adjusted from 0° to 70°.

Note: When operating the head angle adjustment, the base of the head section slides progressively towards the head end of the bed. This action stretches the pelvic section of the bed and helps prevent compression of the abdomen.

Bed Deck Height Adjustment



Function: The bed deck height adjustment buttons allow the bed's height to be adjusted

Operation: To move the bed deck up or down, press and hold the appropriate button on the control panel with the symbol depicted.

Knee Adjustment



Function: The knee-gatch adjustment buttons allow the knee section to be adjusted between 0° and 35°.

Operation: To move the knee-gatch section up or down, press and hold the appropriate button with the symbol as depicted.

Chair



Function: Chair positioning provides synchronized movement of the head section, knee-gatch section and Reverse Trendelenburg in one operation.

Operation: Press and hold to move the bed into a chair position.

Note: When operating the Comfort Chair button, the base of the head section slides progressively towards the head end of the bed. This action stretches the pelvic section of the bed and helps prevent compression of the abdomen.

Contour



Function: Contour positioning provides synchronized movement of the head section and knee-gatch section in one button operation.

Operation: Press and hold to move the bed into a contour position until the correct angular position is reached.

AutoTransfer Height



Function: AutoTransfer Height positioning provides synchronized movement of the head section and knee-gatch section in one button operation to achieve a horizontally level bed deck at a pre-programmed transfer height of 12”.

Operation: Press and hold to lower both head and knee to a level position and place bed at transfer height.

Programmable Transfer Height

To Change Pre-Set (Transfer Height) Height:

Place bed deck at new desired transfer height using the Up or Down buttons - Simultaneously press and hold 'Level All' + 'Backrest Lock' buttons for 5 seconds to confirm setting at new height.

PRESS Simultaneously  + 

To Change back to Default Pre-Set Height (12”):

Simultaneously Press and Hold ‘Level All’ + ‘Bed Height Lock’ buttons for 5 seconds to re-set the Default Height back to 12”.

PRESS Simultaneously  + 

Trendelenburg



Function: The Trendelenburg button allows the bed to be positioned in a head down/foot up position. Trendelenburg position is achievable between 0° to 14°.

Operation: Press and hold to move the bed deck to the desired angle, digitally displayed briefly in the control panel window.

Gravity Assist: Gravity Assist limits the head down angle to 4°. The caregiver can select the 4° Gravity Assist mode for patient safety and positioning. See Gravity Assist section below

Note: To reverse the Trendelenburg angle, press the Reverse Trendelenburg button. When reversing the bed deck angle (toward Reverse Trendelenburg), it will automatically pause at the 0° horizontal position. To continue in the same direction, continue to press and hold button to move bed to the appropriate position.



Caution: The Trendelenburg positions should only be set under clinical advisement.

Reverse Trendelenburg



Function: The Reverse Trendelenburg button allows the bed to be positioned in a foot down/ head up position. Reverse Trendelenburg position is achievable between 0° and 14°.

Operation: Press and hold to move the bed deck to the desired angle, digitally displayed briefly in the control panel window.

Note: To reverse the Reverse Trendelenburg angle, press the Trendelenburg button. When reversing the bed deck angle (toward Trendelenburg), it will automatically pause at the 0° horizontal position. To continue in the same direction, continue to press and hold the button to move bed to the appropriate position.



Caution: The Trendelenburg positions should only be set under clinical advisement.

Gravity Assist Mode

Function: The bed is set to 4° Gravity Assist mode on initial startup. This mode limits the head down angle to 4°. The caregiver can select the 14° Trendelenburg mode to enable Trendelenburg functionality.

Operation: Simultaneously, press and hold Trendelenburg and reverse Trendelenburg buttons for 5 seconds on the Staff Control Panel. Trendelenburg/ Reverse Trendelenburg lock icon will begin flashing indicating that the system is in angle selection mode. For Trendelenburg, press 'bed up' button to select full 14° Trendelenburg mode. To return to 4° Gravity Assist, press 'bed down' button after following step one.

Under Bed Floor Lighting



Function: Under bed floor lighting provides illumination to the area beneath the bed. The bed exit alarm will also automatically turn the light on.

Operation: Press and release the appropriate button to turn the light on/off.

Brake

Function: The brake locks casters to prevent bed frame movement.

Operation: Move bed frame into position and step down on the brake pedal located the foot of the bed until fully engaged. To release, lift pedal up until horizontal to unlock all casters.

Steer

Function: The steer will lock the foot end (identified by yellow cap) caster into straight alignment for easier bed navigation.

Operation: Lift up on the brake pedal until fully engaged. To release, step down on the pedal until horizontal to unlock all casters.

CPR



Function: The CPR button lowers the head of bed angle and knee-gatch to flat position, and then lowers the deck height.

Operation: Press and hold to flatten the head of bed and knee-gatch to horizontal position. Once the knee and head sections are horizontal the bed deck will lower. If the button is released, the bed movement will stop. Press and hold the button until the desired position is reached.

Nurse Call Button



Function: The nurse call button sends a signal to the nurse call system when pressed.

Please note this feature will only communicate when properly connected to a nurse call system.

Operation: Press and release to send a signal to the nurse call system.

Function Lockout

Function: The function lockout button disables one or more bed functions.

Operation: Press and release the lock button under the head, Hi/Lo or knee-gatch section buttons to lockout individual controls. To release the lockout, press and release the same button again. This function can be enabled or disabled from either the side rail or foot panel control panels. To lockout all functions, press and hold any adjacent set of two lockout buttons simultaneously. Repeat to unlock all functions.

Patient Weigh Scale

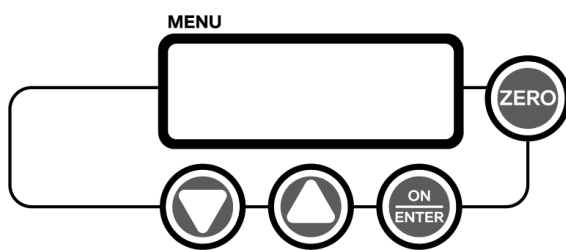

The patient scale monitors and records the weight and weight change of a patient.

Patient Scale Menu Options

Main menu and sub-levels of the scale system.

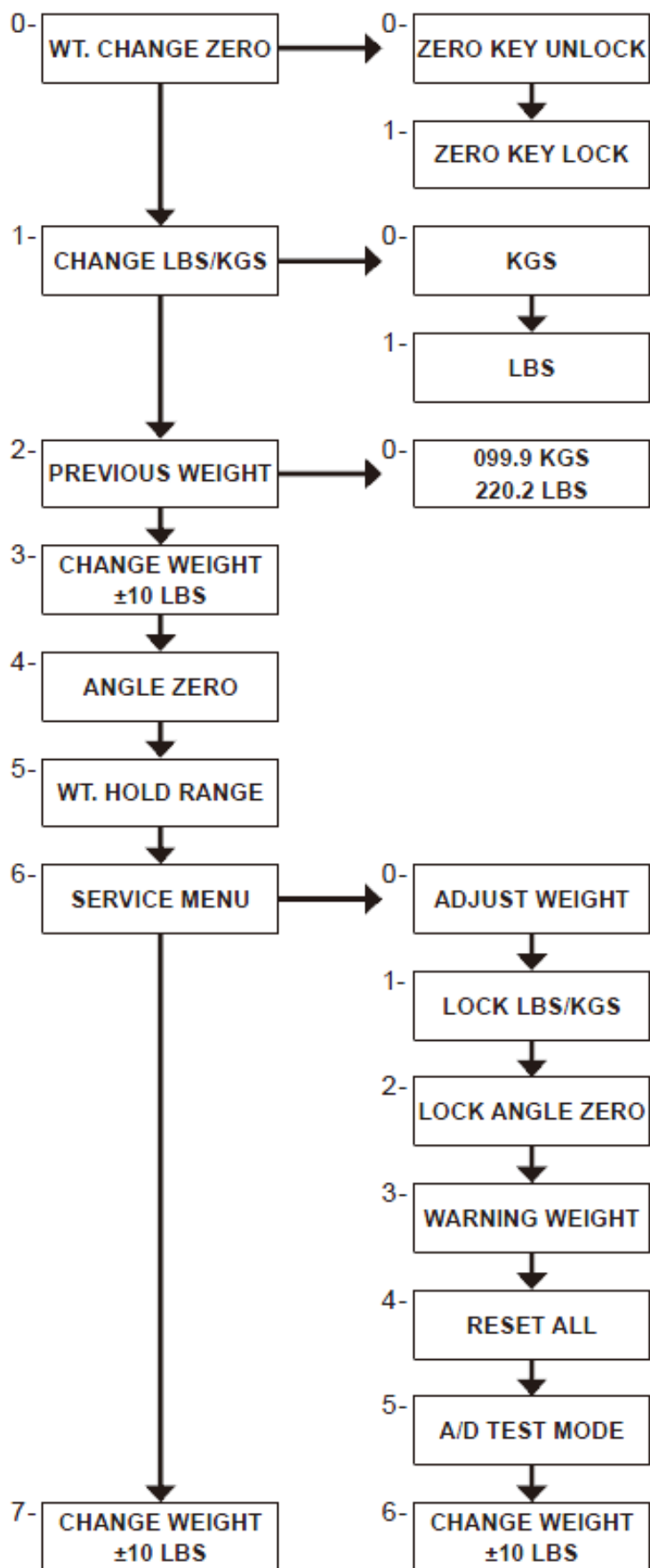

Patient Scale Display and Function (New Patient)

Note: With bed mattress, pillow and linens in-place, perform the following set up prior to placing the patient on the bed.

1. Press and hold the ZERO button until countdown begins, then release. Display counts down from 5 to 0 seconds, visually resetting the weight to zero (0.0 lbs). Note: The bed is now ready to place patient on mattress.
2. Place patient on bed and allow for the displayed weight in the window to remain constant. A symbol “^” under the displayed weight of the new patient will appear indicating a stabilized value has been recorded; at this moment, the value will be saved and locked into the scale memory automatically. The bed exit alarm can now be set.
3. Check patient’s data:
 - a. Patient’s Weight: Press and release the ON/ ENTER button to display patient weight.
 - b. Patient’s Weight Change: Press and release ON/ENTER button twice to display options. Press and release the scale UP and DOWN buttons to scroll through the menu, find “Change Weight” and the patient’s weight change is displayed.

To exit menu:

Press and release the scale UP and DOWN buttons to scroll through menu. Select “Exit Menu,” then press and release the ON/ENTER button. Upon exiting the menu, patient’s weight will be displayed again briefly.

Bed Exit Alarm System

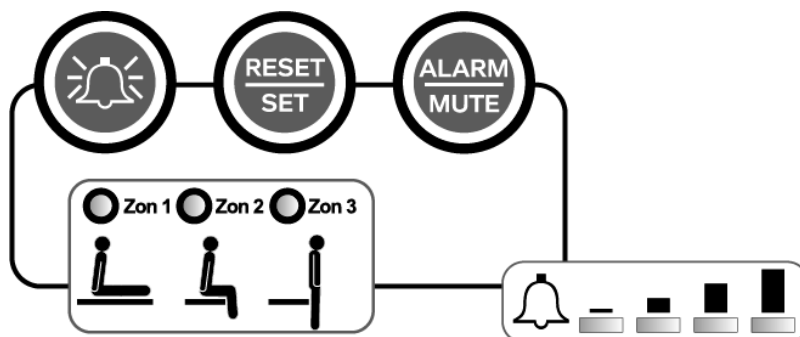

1. With patient in bed, press and release the RESET/ SET button and scroll through the zones to select the appropriate sensitivity (zone 1, 2 or 3). An indicator light will illuminate next to the selected zone.
2. Select the appropriate audio volume level by pressing the ALARM button as needed to scroll through the options (mute, low, med and hi). An indicator light will be seen showing the selected level is activated, including the mute mode (in this mode the exit alarm will only activate through the nurse call system if connected).
3. The alarm can be temporary muted by pressing and releasing the ALARM/MUTE button. The button’s light color will change to green indicating that the audio is off, but the exit alarm remains active if connected to the nurse call system.

Note: Zone 1 can be disabled:

1. Press and hold the Reset/Set button + Contour for 5 seconds to disable/enable Zone 1.



- a. Zone 1 LED will flash once to signify the zone is disabled
- b. Zone 1 LED will flash twice to signify the zone is enabled

2. When Zone 1 is disabled, only Zone 2 + Zone 3 will be available for patient monitoring.

Battery Backup System

The bed is equipped with a battery backup system, which allows the electrically operated functions to be used when the bed is disconnected from the main power source. The bed transitions between main power and battery power automatically. To charge the battery, connect the power cord to a grounded hospital-grade receptacle. The bed should be plugged in as often as possible to maximize battery life.

If the bed is not used for a long period of time, it is recommended that the battery be charged at least 24 hours before operating on battery power.

Note: Keep the bed plugged into a main power receptacle for optimum performance and higher adjustment speeds.

Bed adjustments will be slower when the power cord is unplugged and the bed is powered from its battery backup system.



Illuminates when plugged in



Illuminates when unplugged and fully charged



Illuminates when battery charge is low

Manual Bed Controls

Side Rails

The standard split side rails have two positions: up and down. When the side rail is raised to its up

position, it will automatically be locked in place.

Side Rail Operation

Note: The side rail will only lock in the up position.

From the up position to lower position (Figure 4): While holding the upper hand-hold of the side rail, pull the green lever up to release and lower the side rail (there is no lock in the down position).



Figure 4

From the lower position to the up position (Figure 5): while holding the upper hand-hold of the side rail, lift the side rail to the up position, the lever will automatically click into its locked position.



Figure 5

Manual Cardiopulmonary Resuscitation (CPR) Release Function

The emergency CPR release handles are positioned in the pelvic area on both sides of the bed. The manual release function returns the bed's head section to a fully down position in the event of an emergency resuscitation. To manually lower the head section in an emergency, pull out one of the red release handles marked "CPR" (Figure 6). If the head section does not go down on its own push the head section with one hand while still engaging the CPR handle with the other.



Figure 6

Note: If manual CPR is utilized, the side rail will display the last head of bed angle position. To reset the display, press and hold the head down button on the caregiver side rail control panel.

Warning: The head section will lower quickly – keep fingers clear to avoid pinching.

Alternatively, the CPR function can be activated electrically from the foot panel control panel. Press and hold the red CPR button to move the bed into the desired height. If the button is released, the bed movement will stop. Press and hold the button until the desired position is reached.

Length and Width Expansion (Mattress Bed Deck)

The length of the bed deck is extendable from 80" to 84" and 88". The width of the bed deck is expandable from 35" to 42" and 48".

To extend length:

1. Pull up on the extension lock at the foot-end of the bed to release lock in current position (lock is spring loaded so if when released, lock will reengage) (Figure 7).



Figure 7

2. Grab the frame of the foot panel and gently pull out. Extension lock can be released and will reengage at the pre-designated length of 84". To confirm proper lock engagement, move the foot panel back and forth. Repeat step for 88" extension. When expanded to 84" & 88", remember to expand the panel on the foot section to match sleeping deck with bed frame length.

3. The extend the foot panel section pull black knob in the center of the foot section to disengage lock (Figure 8). Grab the end of the foot section and pull toward foot panel. Release the knob to lock into place at the pre-designated length of 84" & 88"



Figure 8

Note: Do not extend Bed Frame by grabbing the foot board panel.

To expand width:

The expansion lock for all width extensions is located on underside of the first bar of each deck section closer to the head end (Figure 9).



Figure 9

1. Push up on the expansion lock to release (lock will reengage when released (Figure 10)).



Figure 10

2. With lock released grab the deck extension and pull out. Extension lock can be released and will reengage at first the slot to achieve 42" length.
3. To ensure the extension is locked, push or pull on the bar. Repeat the above steps on all

remaining extension sections.

4. Repeat these steps to extend to 48" length if applicable.

Foot Section Leg Lift Adjustment

The foot section angle is adjustable when the knee-gatch section of the mattress support surface is elevated.

To Elevate Foot Section Horizontally

While grasping the outer edges of the knee-gatch panel close to the footboard (Figure 11), lift upwards slowly to an elevation angle slightly past the desired position. The foot section has two ratchet struts that will produce a clicking sound as the spring-loaded locking mechanisms travel past the range of available locking positions. Once the desired position has been reached, gently allow the foot panel to lower. The locking mechanism will automatically find the first available ratchet position.

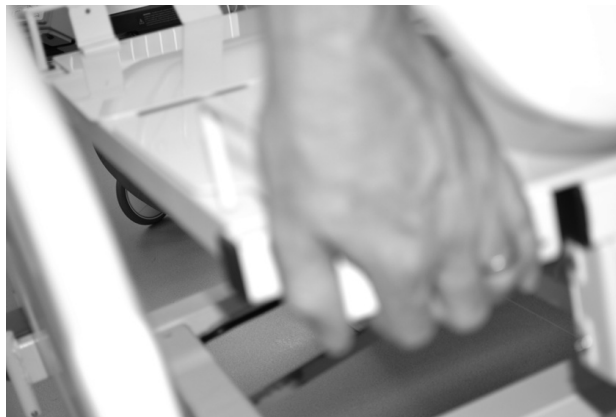

Figure 11

To Lower Foot Section

While grasping the outer edges of the foot section close to the footboard, lift upwards slowly to release the spring locking mechanism. Then, slowly lower the foot section until firmly returned to its original position resting on the main frame.

Patient Pendant Operation

The patient hand pendant allows the patient to adjust the bed frame. Motion occurs only while a button is pressed and held. Motion will stop when the button is released or the applicable bed section reaches the end of its range of motion.

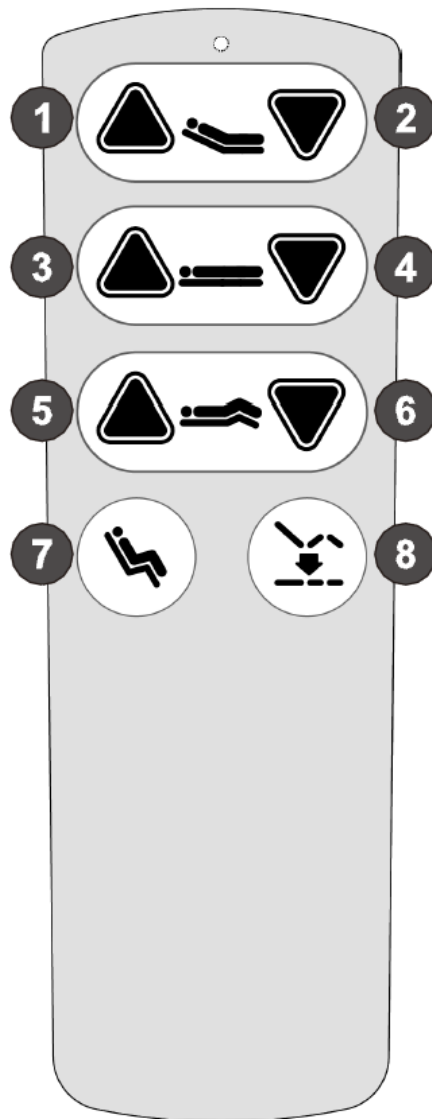

1. Push button to raise head
2. Push button to lower head
3. Push button to raise bed
4. Push button to lower bed
5. Push button to raise knee-gatch
6. Push button to lower knee-gatch
7. Push button for Chair
8. Push button to lower both head and knee to level position and set at transfer height

Additional Features

Nurse Call Connectivity



To connect bed to a nurse call system, a standard 37 pin connection and ¼" jack are located at the head end of the bed below the mattress support platform (Figure 12). When connected, bed will send an alarm signal to the nurse call station if nurse call button is pressed on the patient control panel. In addition, the nurse call station will be signaled if bed exit

alarm is triggered (See scale section for operation).



Figure 12

Safety Stop System

The weight scale system is designed to detect when the bed frame comes in contact with an object while lowering. If that occurs, the bed will stop lowering. If the bed is in the process of lowering and has traveled at least 4" below the highest bed height setting, the bed will stop and raise approximately 1.5" to free any potential obstruction.

Integrated USB port

Integrated USB ports located on each of the patient side rail controls provide power to USB enabled portable electronic devices (Figure 13). To utilize the USB port, slide the port cover to open position and insert a USB cable into port. Connect cable to electronic device such as a phone or music player.

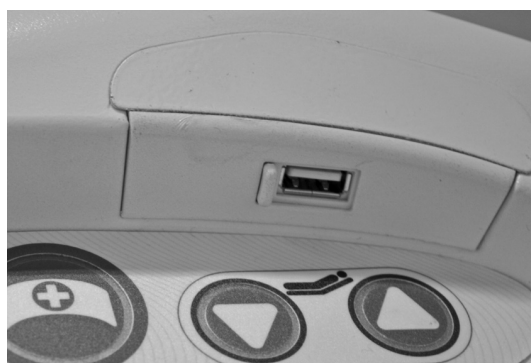

Figure 13

Integrated Pump Holder

The foot board panel of the bed features an integrated pump holder designed to easily attach most air mattress pumps, sequential compression devices (SCDs), and other equipment designed to be hung on a bed frame.

Auxiliary Power Outlet (Select Models)

The bed is equipped with a 110V hospital grade auxiliary power outlet. The outlet receives power through a dedicated black power cord. If the auxiliary power outlet is not powering a device, check that the power cord is plugged into a power source and that the circuit breaker (located next to the

power outlet) does not need to be replaced.

Optional Trapeze/Patient Helper Accessory

The optional trapeze/patient helper has a limited safe working load (SWL). Refer to Trapeze label for specific SWL. The trapeze handle height can be adjusted by shortening the handle length. To shorten the handle length, grasp the handle and position at the desired height, then adjust the strap to the appropriate length on the patient helper bar.

The trapeze has three handle positions:

1. Centered (Figure 15): Positions the trapeze handle above the patient's upper torso to provide assistance during positioning.



Figure 15

2. Off set (Figure 16): Positions the trapeze handle and patient helper bar to the side of the bed for assistance during egress.



Figure 16

3. Left and Right location: The trapeze bar can be installed on the left or right side per patient need.

⚠ Caution: The Patient Helper Bar is only to assist with repositioning on the mattress or during egress from the bed. It is not designed to the full weight of the patient.

Cleaning Procedures

Eye protection must be worn at all times during the cleaning and disinfection process.

 **Caution:** Avoid the use of running water and/or pouring disinfectant liquids during the cleaning process of the bed frame sections.

Recommended Clinical Disinfection Liquids

1. Quaternary Ammonium Disinfectant
2. Activated Hydrogen Peroxide
3. Sodium Hypochlorite (bleach) 1:10 ratio with water

Note: Specific disinfectants may be required by individual clinical facilities.

 **Caution:** Make sure to follow manufacturers' instructions when mixing and using cleaning/disinfecting products for optimal results.

 **Warning:** Prior to the commencement of any disinfection process, make sure the power cord is disconnected.

 **Warning:** Wear appropriate protective gloves, safety glasses and other personal protective equipment at all times during the cleaning/disinfection process.

Disinfecting

Use of a microfiber washcloth is recommended during the cleaning and disinfection process. For the removal of stubborn stains, use a soft bristle brush.

Rinsing

Avoid the use of running water or pressurized spray. Always rinse with a clean microfiber washcloth.

 **Caution:** Allow for sufficient drying time before any reintroduction of the bed frame into a clinical environment.

 **Caution:** Always use caution to avoid the potential of cross contamination.

Preventative Maintenance

Inspection and Maintenance

 **Warning:** Disconnect power cord(s) from wall outlet before cleaning.

 **Warning:** Do not use power wash or high pressure cleaner on any bed part.

 **Warning:** Lock casters when cleaning, inspecting or performing any maintenance of the bed.

Initial Inspection

It's recommended to perform a routine inspection upon initial receipt of bed to ensure optimal bed functionality.

Specific Check Points For Inspection

1. Actuator bolts - Check attachment points and hardware for deformity and general wear
2. Mechanism pivot points - Check for wear
3. Castors - Check stem tightness, tire, brake cam and bearing wear
4. Central lock - Check linkage for wear
5. Side Rail - Check for smoothness of operation
6. Head/Foot boards - Check for damage
7. Mattress Deck - Check pivot points for tightness and wear
8. Frame Fatigue - Check for any abnormal distortion and weld cracking
9. Bumpers - Check for ease of rotation and wear
10. Labels - Check that all cautionary labels are legible and in place
11. Handset - Check for cracks and cable damage
12. Power Cable - Check for insulation damage and condition of plug prongs
13. CPR Release - Check for cable adjustment and operation under load (approx. 40 lbs. of sand bags)
14. Check for general overall bed frame condition and cleanliness.

Twelve (12) Month Preventative Check

In addition to initial Inspection procedures above, the following preventative maintenance procedures should be carried out annually.

General Checks

1. Examine the bed for obvious signs of damage. All aspects of the equipment should operate as intended. Check that all nuts, bolts and other fasteners are tight and are not missing.
2. Examine flexible cable and conduits for cuts, cracks, abrasions or other deterioration.
3. Check that the power supply plug is not damaged. If either the power cable or plug is damage then both the cable and plug must be replaced as a complete assembly.

Central Locking System

1. Apply the brakes and push the bed forwards. If any of the four braking castors rotate the brake is not fully effective, and should be replaced
2. Check the steer lock castor for correct operation.

Trapeze/Patient Helper

Examine the strap and handle for signs of damage.

Side Rails

Where side rails are fitted -check:

1. The locking pin mechanism and striker plate arrangement should be checked.
2. Inspect the side rails for general wear and tightness of fittings, including pivot joints and mounting brackets.
3. Check for rust, structural integrity of welds and pain finish.

Storage

Store in a clean dry area.

Plug bed power cord into grounded hospital-grade electrical outlet. Backup batteries, if equipped, maintain the longest life if kept charged and are not allowed to fully discharge. Failure to keep bed plugged in will discharge backup batteries and shorten their life.

Lubrication Servicing

Recommended Lubricants

Lubricant: Super Lube® Multi-Purpose Aerosol.

Grease: Use Super Lube® synthetic grease or equivalent.

Oiling Points

Keep pins and bolts oiled.

Oil hinge points.

Grease Points For Mattress Support Platform

Grease Side and Foot Extensions.

Troubleshooting

Pendant and Staff Control Troubleshooting

Problem	Solution
If movement does not occur when Pendant or Staff button is pushed	<ol style="list-style-type: none">1. Check for function lockout on Staff Controls.2. Function may be at maximum or minimum level.3. Bed is not plugged into power source and backup battery has discharged. Plug bed into wall outlet.4. Check pendant cord for physical damage. If cord is damaged, discontinue bed usage until cord is replaced.

If adjustment only partially occurs, stops and beeps	<ol style="list-style-type: none"> 1. Backup battery may be low. Plug bed into power source. 2. Check Safe Working Load or for any obstructions near the bed. 3. If a safety stop occurs while lowering the bed, there may be an obstruction. Raise bed to check and clear obstruction. Lower the bed to confirm operation. If problems persist, contact Prius Healthcare USA.
Bed not responding to staff control	<ol style="list-style-type: none"> 1. Check function lockout status. 2. Check Foot Board connection is fully inserted with cable secured. 3. Check the bed is plugged into power source and power unit green light is illuminated. 4. Unplug bed and reset battery for 60 seconds, and plug it back in. 5. If these steps fail to resolve the problem, call Prius Healthcare USA.
All lockouts indicators flashing	<ol style="list-style-type: none"> 1. Push and hold Hi-Lo up and down on staff control or pendant simultaneously until flashing stops (No more than 15 seconds). 2. Unplug bed for 60 seconds and plug back in. 3. If these steps fail to resolve the problem, call Prius Healthcare USA.
Knee Lockout indicator flashes when attempting articulation	<ol style="list-style-type: none"> 1. If bed is in a reverse Trendelenburg or Chair position, level bed deck to enable knee-gatch operation. 2. Lower or raise Hi-Lo function to end of travel. 3. If these steps fail to resolve the problem, call Prius Healthcare USA.

Problem	Possible Cause	What to Do
Bed movement with all casters locked.	<ol style="list-style-type: none"> 1. Braking mechanisms may be worn on one or more casters. 	<ol style="list-style-type: none"> 1. Remove bed from use and contact Prius Healthcare USA.
Scale System display is blank after scale button is pushed.	<ol style="list-style-type: none"> 1. Main power cord may be unplugged and battery backup has become exhausted of power. 2. Unit is defective. 	<ol style="list-style-type: none"> 1. Plug in main power cord. 2. Contact Prius Healthcare USA.
Scale System gives suspect readings.	<ol style="list-style-type: none"> 1. Foot Board cable connection may have 	<ol style="list-style-type: none"> 1. Check for proper connection. 2. Refer to calibration section of this

	<p>disconnected.</p> <ol style="list-style-type: none"> Weight scale may need calibration performed. There may be an obstruction under bed. 	<p>manual.</p> <ol style="list-style-type: none"> Raise bed to ensure no obstruction is present.
<p>Mattress Bed Deck sections do not extend.</p>	<ol style="list-style-type: none"> Latch handles not fully disengaged. Possible Binding. 	<ol style="list-style-type: none"> While pushing the latch handle, try to extend the mattress bed deck extension. Refer to width or length extension section of this manual. Wider bed deck sections may require two hands to apply equal pull force. Contact Prius Healthcare USA.
<p>Mattress Bed Deck sections do not contour.</p>	<ol style="list-style-type: none"> Pendant or Staff Control operation. Staff Control function may be locked out. Bed may be defective or damaged. 	<ol style="list-style-type: none"> Refer to Pendant or Staff Control Troubleshooting above. Refer to staff control section of this manual to unlock Staff Controls. Remove bed from use and contact Prius Healthcare USA.
<p>Actuator push tube will only move inwards and not outwards.</p>	<ol style="list-style-type: none"> Unit may be defective or damaged. Possible synchronization problems. 	<ol style="list-style-type: none"> Remove bed from use and contact Prius Healthcare USA.
<p>Actuator motor makes sound, but push tube does not move.</p>	<ol style="list-style-type: none"> Unit may be defective or damaged. 	<ol style="list-style-type: none"> Remove bed from use and contact Prius Healthcare USA.
<p>Actuator runs too slowly or does not give full power.</p>	<ol style="list-style-type: none"> Main power cable may not be plugged in and is running on battery backup with low charge. Unit may be defective or damaged. 	<ol style="list-style-type: none"> Plug in main power cord and perform test. Remove bed from use and contact Prius Healthcare USA.

EMC Related Notifications

Manufacturer's declaration-electromagnetic emissions		
<p>The <u>Ai1-Premium</u> is intended for use in the electromagnetic environment (for professional healthcare) specified below.</p> <p>The customer or the user of the <u>Ai1-Premium</u> should assure that it is used in such an environment.</p>		
Emission test	Compliance	Electromagnetic environment-guidance (for professional healthcare environment)
RF emissions CISPR 11	Group 1	The <u>Ai1-Premium</u> uses RF energy only for its internal function. Therefore, its RF

		emissions are very low and are not likely to cause any interference in nearby electronic equipment.
RF emissions CISPR 11	Class A	The <u>Ai1-Premium</u> is suitable for use in all establishments other than domestic and those directly connected to the public low-voltage power supply network that supplies buildings used for domestic purposes.
Harmonic emissions IEC 61000-3-2	Not applicable	
Voltage fluctuations /flicker emissions IEC 61000-3-3	Not applicable	

Recommended separation distance between portable and mobile RF communications equipment and the Ai1-Premium

The Ai1-Premium is intended for use in an electromagnetic environment (for professional healthcare) in which radiated RF disturbances are controlled. The customer or the user of the Ai1-Premium can help prevent electromagnetic interference by maintaining a minimum distance between portable and mobile RF communications equipment (transmitters) and the Ai1-Premium as recommended below, according to the maximum output power of the communications equipment.

Rated maximum output power of transmitter W	Separation distance according to frequency of transmitter m		
	150 kHz to 80 MHz $d = 1,2\sqrt{P}$	80 MHz to 800 MHz $d = 1,2\sqrt{P}$	800 MHz to 2,7 GHz $d = 2,3\sqrt{P}$
0,01	0,12	0,12	0,23
0,1	0,38	0,38	0,73
1	1,2	1,2	2,3
10	3,8	3,8	7,3
100	12	12	23

For transmitters rated at a maximum output power not listed above, the recommended separation distance d in meters (m) can be estimated using the equation applicable to the frequency of the transmitter, where p is the maximum output power rating of the transmitter in watts (W) according to the transmitter manufacturer.
 NOTE1 At 80 MHz and 800 MHz, the separation distance for the higher frequency range applies.
 NOTE2 These guidelines may not apply in all situations. Electromagnetic propagation is affected by absorption and reflection from structures, objects and people.

The Ai1-Premium is intended for use in the electromagnetic environment (for professional healthcare) specified below.

The customer or the user of the Ai1-Premium should assure that it is used in such an environment.

Immunity test	IEC 60601 test level	Compliance level	Electromagnetic environment-guidance (for professional healthcare environment)
Electrostatic discharge(ESD) IEC 61000-4-2	Contact: ± 8 kV Air ± 2 kV, ± 4 kV, ± 8 kV, ± 15 kV	Contact: ± 8 kV Air ± 2 kV, ± 4 kV, ± 8 kV, ± 15 kV	Floors should be wood, concrete or ceramic tile. If floors are covered with synthetic material, the relative humidity should be at least 30%
Electrical fast transient/burst IEC 61000-4-4	± 2 kV for power supply lines ± 1 kV for input/output lines	± 2 kV for power supply lines Not applicable	Mains power quality should be that of a typical professional healthcare environment.
Surge IEC 61000-4-5	± 0.5 kV, ± 1 kV line(s) to line(s) ± 0.5 kV, ± 1 kV, ± 2 kV line(s) to earth	± 0.5 kV, ± 1 kV line(s) to line(s) ± 0.5 kV, ± 1 kV, ± 2 kV line(s) to earth	Mains power quality should be that of a typical professional healthcare environment.
Voltage Dips, short interruptions and voltage variations on power supply input lines IEC 61000-4-11	Voltage dips: 0 % U_T ; 0,5 cycle 0 % U_T ; 1 cycle 70 % U_T ; 25/30 cycles Voltage interruptions: 0 % U_T ; 250/300 cycle	Voltage dips: 0 % U_T ; 0,5 cycle 0 % U_T ; 1 cycle 70 % U_T ; 30 cycles Voltage interruptions: 0 % U_T ; 300 cycle	Mains power quality should be that of a typical professional healthcare environment. If the user of the <u>Ai1-Premium</u> requires continued operation during power mains interruptions, it is recommended that the <u>Ai1-Premium</u> be powered from an uninterruptible power supply or a battery.
Power frequency(50, 60 Hz) magnetic field IEC 61000-4-8	30 A/m 50 Hz or 60 Hz	30 A/m 60 Hz	The <u>Ai1-Premium</u> power frequency magnetic fields should be at levels characteristic of a typical location in a typical professional healthcare environment.

NOTE U_T is the a.c. mains voltage prior to application of the test level.

The Ai1-Premium is intended for use in the electromagnetic environment (for professional healthcare) specified below.

The customer or the user of the Ai1-Premium should assure that it is used in such and environment.

Immunity test	IEC 60601 test level	Compliance level	Electromagnetic environment-guidance (for professional healthcare environment)
Conducted RF IEC 61000-4-6	3 Vrms: 0,15 MHz – 80 MHz 6 Vrms: in ISM bands between 0,15 MHz and 80 MHz 80 % AM at 1 kHz	3 Vrms: 0,15 MHz – 80 MHz 6 Vrms: in ISM bands between 0,15 MHz and 80 MHz 80 % AM at 1 kHz	Portable and mobile RF communications equipment should be used no closer to any part of the <u>Ai1-Premium</u> including cables, than the recommended separation distance calculated from the equation applicable to the frequency of the transmitter.
Radiated RF IEC 61000-4-3	3 V/m 80 MHz – 2,7 GHz 80 % AM at 1 kHz	3 V/m 80 MHz – 2,7 GHz 80 % AM at 1 kHz	Recommended separation distance: $d = 1,2 \sqrt{P}$ $d = 1,2 \sqrt{P}$ 80MHz to 800 MHz $d = 2,3 \sqrt{P}$ 800MHz to 2,7 GHz Where P is the maximum output power rating of the transmitter in watts (W) according to the transmitter manufacturer and d is the recommended separation distance in metres (m). Interference may occur in the vicinity of equipment marked with the following symbol: 

NOTE1 At 80 MHz and 800 MHz, the higher frequency range applies.

NOTE2 These guidelines may not apply in all situations. Electromagnetic propagation is affected by absorption and reflection from structures, objects and people.

Manufacturer's declaration-electromagnetic immunity

Test specifications for ENCLOSURE PORT IMMUNITY to RF wireless communications equipment

The Ai1-Premium is intended for use in the electromagnetic environment (for professional healthcare) specified below.

The customer or the user of the Ai1-Premium should assure that it is used in such an environment.

Test frequency (MHz)	Band ^{a)} (MHz)	Service ^{a)}	Modulation ^{b)}	Maximum power (W)	Distance (m)	IMMUNITY TEST LEVEL (V/m)	Compliance LEVEL (V/m) (for professional healthcare)
385	380 – 390	TETRA 400	Pulse modulation b) 18 Hz	1,8	0,3	27	27
450	430 – 470	GMRS 460, FRS 460	FM c) ± 5 kHz deviation 1 kHz sine	2	0,3	28	28
710	704 – 787	LTE Band 13, 17	Pulse modulation b) 217 Hz	0,2	0,3	9	9
745							
780							
810	800 – 960	GSM 800/900, TETRA 800, iDEN 820, CDMA 850, LTE Band 5	Pulse modulation b) 18 Hz	2	0,3	28	28
870							
930							
1 720	1 700 – 1 990	GSM 1800; CDMA 1900; GSM 1900; DECT; LTE Band 1, 3, 4, 25; UMTS	Pulse modulation b) 217 Hz	2	0,3	28	28
1 845							
1 970							
2 450	2 400 – 2 570	Bluetooth, WLAN, 802.11 b/g/n, RFID 2450, LTE Band 7	Pulse modulation b) 217 Hz	2	0,3	28	28
5 240	5 100 – 5 800	WLAN 802.11 a/n	Pulse modulation b) 217 Hz	0,2	0,3	9	9
5 500							
5 785							

NOTE If necessary to achieve the IMMUNITY TEST LEVEL, the distance between the transmitting antenna and the ME EQUIPMENT or ME SYSTEM may be reduced to 1 m. The 1 m test distance is permitted by IEC 61000-4-3.

- a) For some services, only the uplink frequencies are included.
 b) The carrier shall be modulated using a 50 % duty cycle square wave signal.
 c) As an alternative to FM modulation, 50 % pulse modulation at 18 Hz may be used because while it does not represent actual modulation, it would be worst case.

The Prius Healthcare USA Ai1 bed is guaranteed for a period of one year from the date of delivery, against defects in materials and workmanship, under normal use and service.

This one-year warranty includes all mechanical and electrical components.

Steel structural components on beds are covered under warranty for a period of 10 years from the date of delivery.

Damage caused by use in unsuitable environmental conditions, abuse or failure to maintain the product in accordance with user and service instructions is not covered.

Any alteration, modification, or repair unless performed by or authorized in writing by Prius Healthcare USA, will void this warranty.

Parts

Prius Healthcare USA beds contain various parts that wear from normal use. These parts, such as DC batteries, are not covered under the one-year warranty, but are covered for 90 days after date of delivery. A parts list is available upon request.

Prius Healthcare USA's obligation under this warranty is limited to supplying replacement parts, servicing or replacing, at its option, any product which is found by Prius Healthcare USA to be defective.

Warranty replacement parts are covered by the terms of this warranty until the product's original one-year warranty period expires.

When requested by Prius Healthcare USA, parts must be returned for inspection at the customer's expense. Credit will be issued only after inspection.

Service

Most service requests can be handled by the facility Maintenance Department with assistance from the Prius Healthcare USA.

Should a technician be required, one will be provided by Prius Healthcare USA, at our discretion. Only the Prius Healthcare USA can dispatch authorized technicians.

This warranty is extended to the original purchaser of the equipment.

For service, maintenance, warranty and any questions regarding this product, please contact.

Manufacturer's information

Prius Healthcare USA

160 Scarlet Blvd

Oldsmar, FL 34677