

## Table of Content

### Introduction

Practice Before Operating .....	2
---------------------------------	---

### Safety Instructions

Safety Considerations .....	4
Driving Outdoors .....	7
Driving on Various Terrains .....	9

### Familiarize Yourself With Your Powerbase Wheelchair

Feature Diagram .....	11
P301 Specification .....	12
Terminology .....	13
Assembling The Powerbase Wheelchair .....	14

### Adjusting For Comfort

Adjusting The Seat .....	15
Adjusting The Footrest .....	15
Adjusting The Joystick .....	16

### Operating Your Powerbase Wheelchair

Dynamic SHARK Controller Operation .....	17
VR2 Controller Operation .....	26
Seat Lift System (Optional) .....	31
Pushing your Powerbase Wheelchair .....	32
Batteries and Charging .....	33

lec Symbols .....	36
-------------------	----

Warranty .....	37
----------------	----



Welcome aboard your new powerbase wheelchair, and thank you for choosing our product. Please read this manual carefully, and follow all instructions before attempting to operate your powerbase wheelchair for the first time. If there is anything in this manual that you do not understand, or if you require additional assistance for setting up your powerbase wheelchair, Please contact your local dealer.

This latest model is designed for specific practical user needs, combining solid, rugged construction, and modern high-tech electronics, to enhance safety and performance.

With a state-of-the-art, programmable electronic control system, your powerbase wheelchair can be programmed and adjust within a given range of its performance characteristics, to suit your individual needs. The controller is set up at the factory to give the powerbase wheelchair nominal operating performance characteristics.

After becoming familiar with the basic operation of the powerbase wheelchair, you may wish to customize the settings to fit your own personal preferences. A wide range of customization options can be adjusted such as acceleration, deceleration, maximum speed, turning speed, safety controls, better maneuverability of the joystick, and so on. Contact your local dealer for advice on additional equipment you may need.

Have your powerbase wheelchair checked regularly by your local dealer is the best way to ensure smooth operation, and safety.

This manual provides users practical tips and information on safety issues, operation, and maintenance. Please read it very carefully to ensure your maximum enjoyment and to fully benefit from your independence and mobility.

Whenever special advice or attention is needed, please do not hesitate to contact your local dealer, who has the tools and know-how to provide expert servicing for your powerbase wheelchair.

Your satisfaction and opinions are highly valued by your local dealer. Please be sure to fill out the enclosed guarantee form, and return it to your local dealer. The information is necessary for providing you with the best service, and to be sure all of your needs are met.

# P301(MP3W) Powerbase Wheelchair

Failure to follow these instructions may result in damage to the powerbase wheelchair or serious injury.

## ■ Practice Before Operating

Find an open area such as a park and have an assistant to help you practice until you have confidence operating this vehicle.

Make sure that the power is off before getting in or out of the seat. Set the speed control button according to your driving ability.

**We recommend that you keep the speed control at the slowest position until you are familiar with the driving characteristics of this vehicle.**

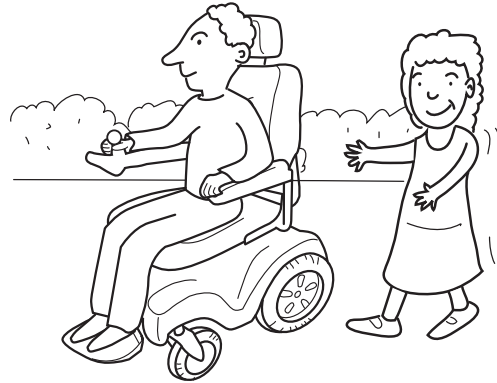

All user controls can be accessed from the simple, ergonomically de-signed panel on the SHARK control unit.

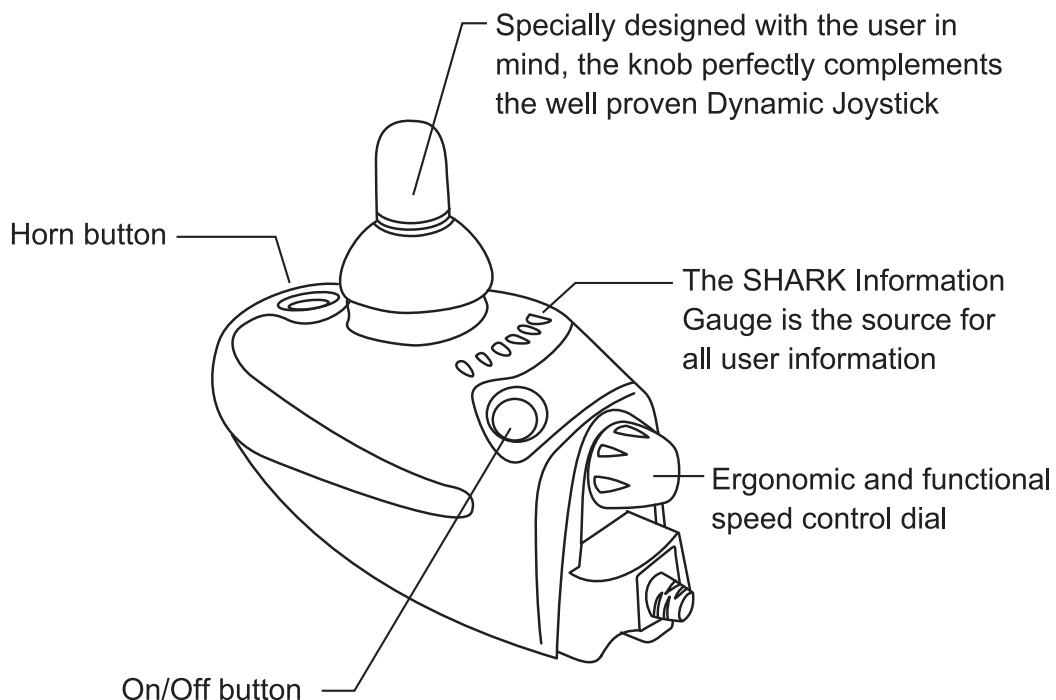

## Getting familiar with this vehicle

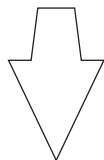

First, practice moving forward.  
Be sure to set the speed to the lowest setting.

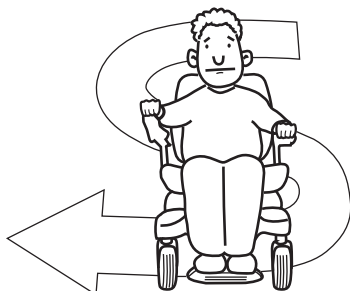

After becoming familiar with moving forward,  
practice marking "S" turns.



Once you are familiar with "S" turns, practice  
moving in reverse. Note that for any speed control  
setting, the vehicle moves more slowly in reverse  
than forward.



# P301(MP3W) Powerbase Wheelchair

## ■ Safety Considerations

DO NOT do any of the following



**NO!**

Do not carry any passengers



**NO!**

Do not drive across a slope



**NO!**

Do not drink and drive  
Consult your physician to  
determine if your medications  
impair your ability to control this  
vehicle



**NO!**

Do not tow a trailer



**NO!**

Do not turn on or use hand-held personal  
communication devices such as citizens band(CB)  
radios and cellular phones

This vehicle has an immunity level of 20 v/m which should protect it from Electromagnetic Interference(EMI) from radio wave sources. The rapid development of electronics, especially in the area of communications, has saturated our environment with electromagnetic (radio) waves that are emitted by television, radio and communication signals. These EM waves are invisible and their strength increases as one approaches the source. All electrical conductors act as antennas to the EM signals and, to varying degrees, all power wheelchairs and power scooters are susceptible to electromagnetic interference (EMI). This interference could result in abnormal, unintentional movement and/or erratic control of the vehicle. The United States Food and Drug Administration (FDA) suggests that the following Statement be incorporated to the user's manual for all electric power wheelchairs.

Powered wheelchairs and electric power scooters (in this text, both will be referred to as powered wheelchairs) may be susceptible to electromagnetic interference (EMI), which is interfering electromagnetic energy emitted from sources such as radio stations, TV stations, amateur radio (HAM) transmitters, two-way radios and cellular phones. The interference (from radio wave sources) can cause the powered wheelchair to release its brakes, move by itself or move in unintended directions. It can also permanently damage the powered wheelchair's control system. The intensity of the EM energy can be measured in volts per meter(V/m). Each powered wheelchair can resist EMI up to a certain intensity. This is called the "immunity level." The higher the immunity level, the greater the protection. At this time, current technology is capable of providing at least 20 V/m of immunity level which would provide useful protection against common sources of radiated EMI.

Following the warnings listed below should reduce the chance of unintended brake release or powered wheelchair movement that could result in serious injury:

- 1) Do not turn on hand-held personal communication devices such as citizens band (CB) radios and cellular phones while the powered wheelchair is turned on.
- 2) Be aware of nearby transmitters such as radio or TV stations and try to avoid coming close to them.

# P301(MP3W) Powerbase Wheelchair

- 3) If unintended movement or brake release occurs, turn the powered wheelchair off as soon as it is safe.
- 4) Be aware that adding accessories or components, or modifying the powered wheelchair, may make it more susceptible to interference from radio wave sources. (Note: there is no easy way to evaluate their effect on the overall immunity of the powered wheelchair).
- 5) Report all incidents of unintended movement or brake release to the powered wheelchair manufacturer, and note whether there is a radio wave source nearby.

## **TURN OFF YOUR POWER WHEELCHAIR AS SOON AS POSSIBLE WHEN EXPERIENCING ANY OF THE FOLLOWEING:**

1. Unintentional motions.
2. Unintended of uncontrollable direction.
3. Unexpected brake release.

The FDA has written to the manufacturers of power wheelchairs, asking them to test their new products to be sure they provide a reasonable degree of immunity against EMI. The letter says that powered wheelchair should have an immunity level of at least 20 V/m, which provide a reasonable degree of protection against the more common sources of EMI. The higher the level, the greater the protection.

## ■ Driving Outdoors

When you are on the road, please pay attention to the following:



**NO!**

Do not drive in traffic.



**NO!**

Do not drive beside a river, port, or lake without a fence or railing.



**NO!**

If possible, do not drive during the rain.



**NO!**

If possible, do not drive during or on snow.



**NO!**

Do not drive off-road or on any uneven surfaced roads.



**NO!**

If possible, do not drive at night.

# P301(MP3W) Powerbase Wheelchair



**NO!**

Make sure that there are no obstacles behind you when in reverse.

We recommend to set up the speed at the lowest setting for reversing.



**NO!**

Do not make sudden stops, weave erratically, or make sharp turns.



**NO!**

Keep your arms on or inside the armrests and feet on the footrest at all time.



**NO!**

Do not attempt to climb curbs greater than 2"(5cm).

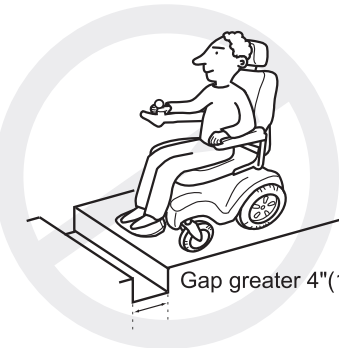

**NO!**

Do not attempt to cross over a gap greater than 4"(10cm).

Gap greater 4"(10cm)

## ■ Driving on Various Terrains

Driving on hills is more dangerous than on level surfaces. If you fail to heed these warnings, a fall, tip-over or loss of control may occur and cause severe injury to the vehicle user or others.



**NO!**

Do not attempt to climb a hill greater than 10°



**NO!**

Do not reverse while driving up a hill.

Forward only. If you reverse while moving up a hill, it may cause the vehicle to tip over.



**NO!**

Do not attempt to drive across a sloping surface greater than 3°

Driving across a slope greater than 3° is very dangerous and may cause the vehicle to tip over.



**NO!**

Do not drive over soft, uneven or unprotected surfaces such as grass, gravel and decks.

# P301(MP3W) Powerbase Wheelchair



**NO!**

**Use low speed while driving down hill.**

When braking while moving down hill, the wheelchair will take longer to come to a complete stop.



**NO!**

**Do not get on and off on a hill.**

Always stop on the level surface to get in and get out of the vehicle.

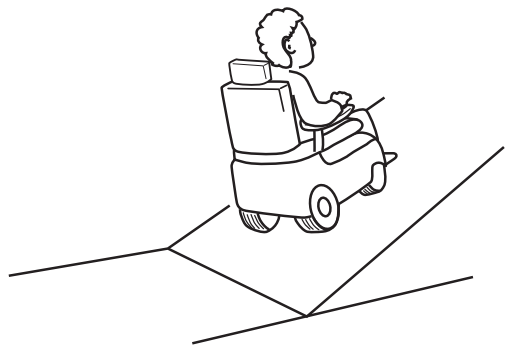

**YES!**

Always climb or descend gradients perpendicular to the slope or ramp.

## ■ Feature Diagram

In this section, we will acquaint you with the many features of your powerbase wheelchair and how they work. Upon receipt of your powerbase wheelchair, inspect it for any damage. Your powerbase wheelchair consists of the following components.



1. Controller
2. Joystick
3. Armrest
4. Cover

5. Drive Wheel
6. Caster Wheel
7. Footrest



# P301(MP3W) Powerbase Wheelchair

## ■ P301 Specifications



Model No.	P301
Length	41.3" (1050mm)
Width	23.5" (600mm)
Seat Height	24.5"~26.5" (from ground)
Caster Wheel	9" (2.80 /2.50-4) foam filled tire
Drive Wheel	14" (3.00-8) foam filled tire
Weight Capacity	350 lbs (158 kgs)
Max. Speed	5 mph (8 kph)
Range	16.8 miles (27 km)
Turning Radius	21" (530mm)
Controller	Dynamic SHARK 60A / PG VR2 60A
Gradient	12°
Battery	12V / 22NF * 2 PCS
Brake	Intelligent, regenerative, electromagnetic brakes
Unit Weight	240.8lbs (109.2lbs)
Charger	5 A off - board

## ■ Terminology

**Joystick:** The device used to "move" the powerbase wheelchair.

**Controller:** The device that allow joysticks to function. Not all joysticks have a controller.

**Armrests:** Where arms can rest during time spent on powerbase wheelchair.

**Cover:** The plastic piece or pieces that cover the powerbase wheelchair.

**Footrest:** Where feet rest during time spent on the powerbase wheelchair.

**Anti-tip Wheels:** Wheels that allow slight tipping, or prevent tipping while driving.

**Drive Wheel:** These are the main wheels. Wheels that move the powerbase wheelchair.

**Caster Wheel:** The back wheels.

**Controller Harness Connectors:** Joystick cables connect to the powerbase wheelchair.

**Freewheel Lever:** L-Shaped levers at the to rear part of the cover.



**WARNING: DO NOT** use the powerbase wheelchair without the presence of an attendant while the drive motors are disengaged! **DO NOT** disengage the drive motors when your powerbase wheelchair is on an incline, as the chair could roll down on its own, causing injury!

To engage or disengage the drive motors:

1. Turn the freewheel levers outward to disengage the drive motors.
2. Turn the freewheel levers toward the front of the powerbase wheelchair to engage the drive motors.

Note: It is important to remember that when the powerbase wheelchair is in the freewheel mode, the braking system is disengaged.

## Assembling The Powerbase Wheelchair

### ■ Installing The Seat

1. Lift the seat and slide the seat post (bottom of the seat) into the seat pedestal.  
Tip: Folding the seat can make it easier to install.
2. Be sure to swivel the seat and push down on the seat until it locks in place.

### ■ Inserting The Height and Width Adjustable Armrests

#### Setting The Initial Width

1. Loosen the knobs on the armrest receiver.
2. Slide armrest into the horizontal receiver brackets.
3. Select desired width and tighten the knobs.

#### Setting The Initial Height

1. Locate and loosen the knobs on the vertical armrest holder.
2. Insert the armrest into the receiver.
3. Select desired height and tighten the knobs as firmly as possible.

#### Installing The Controller

1. Insert controller bracket tube into the receiver.
2. Adjust the controller to your desired length, then tighten it with the Allen wrench.
3. Insert the main plug into the controller socket.

## Adjusting For Comfort

### ■ Adjust The Seat:

#### Setting The Seat Back-Angle

There is provision to set the seat back-angle to one of four positions:

- a) Back vertical (90 degrees)
- b) Back reclined by 10 degrees (100 degrees)
- c) Back reclined by 15 degrees (105 degrees)
- d) Back reclined by 30 degrees (120 degrees)

For reasons of operator forward visibility and vehicle stability, it is suggested that the most forward back-angle be chosen that is consistent with operator comfort.

#### Resetting The Back Angle

1. Note that at the pivot point of the seat back a screw is positioned through the pivot that limits backward motion of the seat back. The left side pivot is imprinted with the stop angles. Observe the current stop position.
2. Remove the nut and screw from the stop position on each pivot.
3. If you need to recline the back more, reposition the stop screws into the stop positions 1 higher than was observed in (1). If you wish to reduce the back angle, reposition the stop screws in the positions 1 lower than was observed in (1).
4. Replace the nuts onto the stop screws to lock the setting.

### ■ Adjust The Footrest

#### Adjusting The Height

(After removing the seat and the cover)

1. Using a 10mm hex wrench, remove the bolts and nuts.
2. Slide the platform to your desired height.
3. Replace the bolts and nuts and be sure to tighten them.

#### Adjusting The Angle

1. Flip up the foot plate for easy access and loosen the nut.
2. With an Allen key, simply turn the bolt counter-clockwise to increase the angle or clockwise to decrease it.
3. Be sure to re-tighten the nuts.

## Adjusting for Comfort

### ■ Adjust The Joystick

#### Adjust The Joystick Length Forward or Backward

1. Flip up the armrest for easy access.
2. Loosen the bracket bolt with an Allen key. Slide the Joystick bracket in or out to your desired length.
3. Re-tighten the bolt.

#### Moving The Joystick to Other Seat Arm

1. Disconnect the joystick cable.
2. Remove both sets of armrests, while the joystick still is secured on one of armrest.
3. Exchange both armrests.  
Be sure to tighten the knobs.

## Operating your Powerbase Wheelchair

### ■ Dynamic Shark Controller Operation:

SHARK heralds the dawn of new thinking in lower cost powerchair control solutions. Using a dedicated power module and control unit, SHARK has none of the compromises that go into the design of one-box controllers - this means more power, unrivalled ergonomics, greater versatility and superior usability.

- Featuring Dynamic's breakthrough "Chair Tamer" technology, meaning unprecedented chair performance, control, and safety.
- Optimally small Control Unit provides the best looks and user ergonomics in the field.
- No heavy power cables running from the armrest to the motors and batteries.
- No hot surfaces for the user to touch.
- A longer and higher current delivery than equivalently rated integral controllers.
- Superior EMC performance due to minimized power wiring.

SHARK is the perfect choice for all cost sensitive "Drive only" applications.

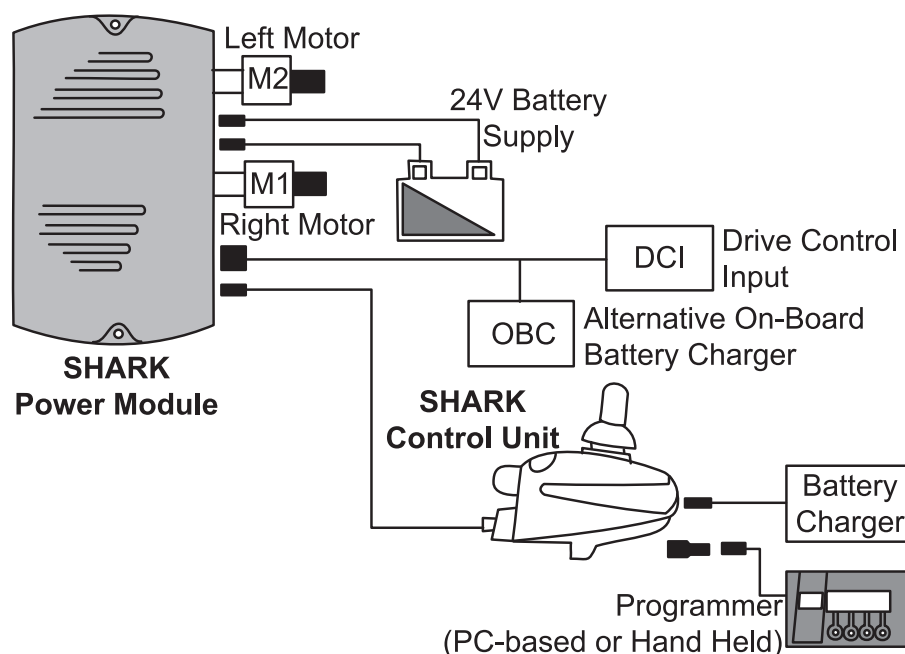

## The SHARK Controller Unit

All user controls can be accessed from the simple, ergonomically designed panel on the SHARK control unit.

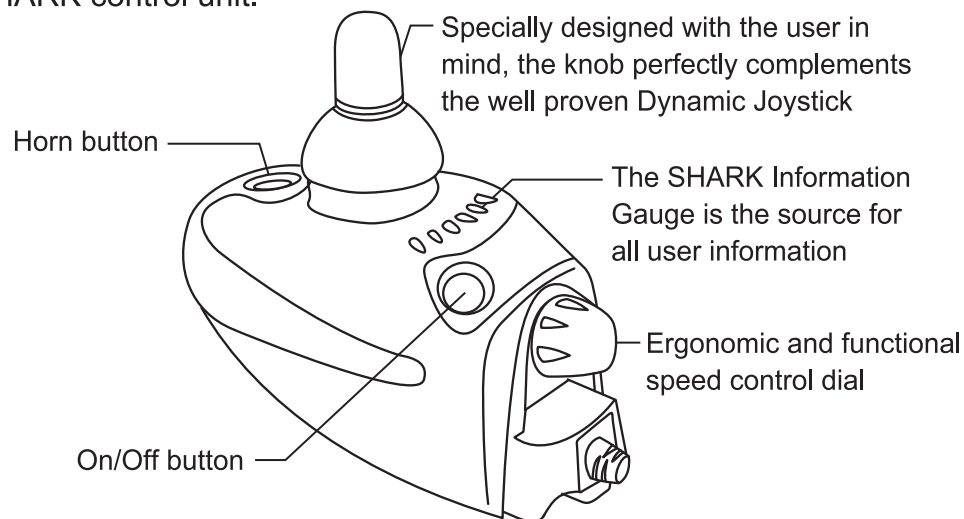



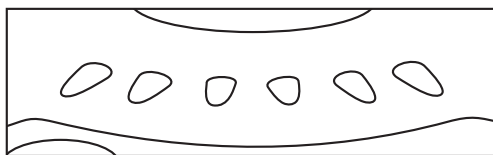



## The Shark Information Gauge

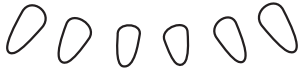

The SHARK Information Gauge is the primary source of user feedback. It displays every possible status that SHARK may have, including;

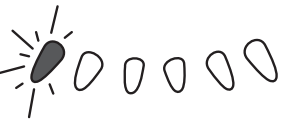
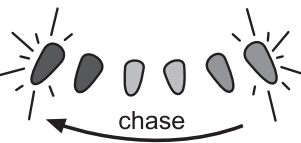
- SHARK Power ON
- True state-of-battery-charge, including notification of when the battery desperately requires charging.
  - Any green LEDs lit indicates well-charged batteries.
  - If only amber and red LEDs are lit, the batteries are moderately charged. Recharge before undertaking a long trip.
  - If only red LEDs are lit, the batteries are running out of charge. Recharge as soon as possible.
- SHARK Lock Mode countdown
- Program, inhibit or charge modes
- Fault indication (Flash Codes)

The following table indicates what the gauge will display for any given state.

Display	Description	Meaning	Notes
	All LEDs OFF	Power is OFF	
	All LEDs ON steady	Power is ON	Fewer LEDs on imply a reduced battery charge.
	Left RED LED is flashing	Battery charge is low	The batteries should be charged as soon as possible.
	Right to left 'chase'	SHARK is being brought out of Lock mode	To unlock SHARK, press the Horn but-ton twice within 10 seconds.
	Left to right 'chase' alternating with steady display	SHARK is in programming, inhibit, and/or charging mode	The steady LEDs indicate the current state of battery charge.
	Right GREEN LED is flashing	SHARK is in speed limit mode	The current state of battery charge will be displayed at the same time.
	All LEDs flashing slowly	SHARK has detected an Out of Neutral at Power Up (OON-APU) condition	Release the joystick back to neutral.
	All LEDs flashing quickly	SHARK has detected a fault	SHARK uses flash codes to indicate faults. Refer to the diagnostics section for further information about fault diagnostics.



## Turning the SHARK On and Off

### Turning the Power ON

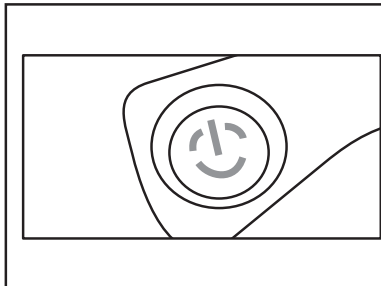

Press the Power button.

All indicators will light briefly.

Either the current battery charge or Lock Mode will then be indicated.

If SHARK is turned on while the joystick is out of neutral, an OONAPU fault will be displayed. Refer to the previous table. Release the joystick back to neutral and the fault will disappear.

OONAPU (Out Of Neutral At Power Up) is a feature that prevents SHARK from driving if the joystick is out of neutral when SHARK is either turned on or an inhibit condition is removed.

This feature prevents sudden and unexpected powerbase wheelchair movements.

### Turning the Power OFF

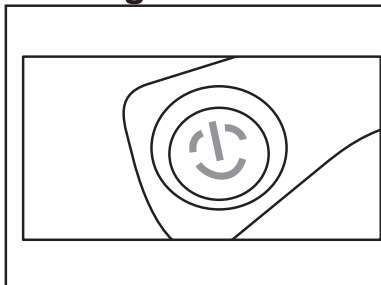

Press the Power button.

The LEDs will turn off.

Alternatively, SHARK may be placed into a Lock Mode. This may be preferable to turning the power off if leaving the powerbase wheelchair at a place where unauthorized persons may attempt to use the powerbase wheelchair.



**The Power button can also be used to turn SHARK off in case of an emergency.**

### Sleep Mode

Some SHARKs may be supplied factory programmed with a Sleep Feature that will automatically turn SHARK off if the joystick has not been moved after a certain period of time (programmable).



After a certain amount of time with no joystick movement SHARK will automatically turn itself off. Sleep mode will not be entered while programming.

Any button press (or joystick movement if Wakeup style has been set to 'Joystick or Button') will bring the system out of sleep mode.

**SHARK may enter Sleep Mode while charging. This will not affect charging of SHARK**

## Driving SHARK

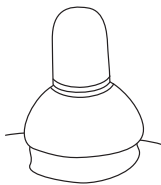

Moving the joystick will cause the powerchair to drive in that direction. The amount of joystick movement will determine the speed that the powerchair will move in that direction.

**For safety reasons joystick movements are ignored when SHARK is first turned on (OONAPU). SHARK will slowly flash the Information Gauge to indicate this.**

**Simply release the joystick back to the neutral position and the error will disappear.**



A user may adjust the top speed of their powerchair to suit their preference or environment by turning the speed control dial.

Simply turn the dial fully clockwise to travel at top speed when the joystick is pushed fully forward. The top speed progressively reduces as the dial is turned counter-clockwise.

## Using The Horn

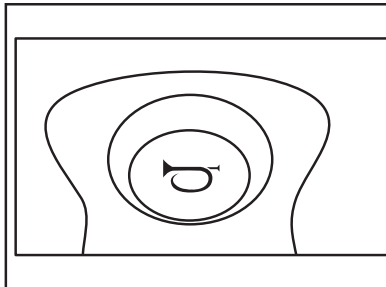

Press the Horn button.

The horn will sound for as long as the button is pressed.

## Locking SHARK

Some SHARKs may be supplied factory programmed with a Lock Feature that prevents unauthorized people from turning SHARK on.

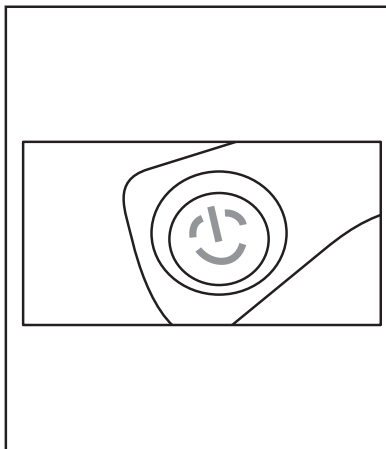

### To Lock SHARK

While the power is ON, press and hold the Power button for 2 seconds.

The display will turn off immediately.  
After 2 seconds all LEDs will flash briefly and the horn will sound a short beep.

The powerchair will then turn off.

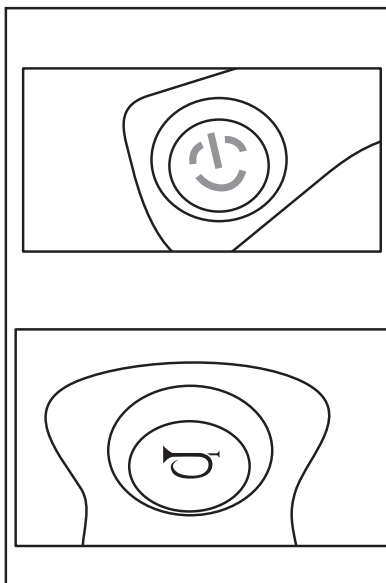

### To Unlock SHARK

While SHARK is locked, press the power button to turn SHARK on.

All LEDs will flash briefly. The LEDs will then perform a slow right-to-left countdown.

Press the Horn button twice before the countdown is completed (approximately 10 seconds).

The current state-of-charge will then be displayed and SHARK may be operated normally.

If the user does not press the Horn button twice before the countdown is complete, the Horn will sound a short beep and SHARK will turn itself off.

The unlock sequence must be completed successfully before SHARK will drive again normally.

## Charging Shark

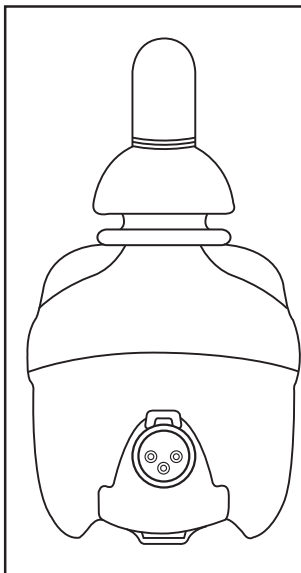

Plug the battery charger into the charging socket located at the front of the SHARK Control Unit.

If the powerchair has an On-board Battery Charger (OBC), simply plug the OBC power cable into an appropriate power outlet.

The SHARK Information Gauge will indicate the system is being charged by cycling between a lift-to-right 'chase' and displaying the current battery state-of-charge.

Driving is prevented (inhibited) while the system is being charged.

Once the Battery Charger displays a full battery charge, the battery charger plug may be removed.

If SHARK is turned off, or goes into sleep while charging, charging will continue.

Although the SHARK Information Gauge will display an approximate battery level while charging, the Battery Charger should be used as the sole judge of charge completion

## Diagnostics

SHARK is not user serviceable. Specialized tools are necessary for the repair of any SHARK component.

## Introduction

A flashing SHARK Information Gauge indicates there is an abnormal condition somewhere on the powerchair. The components that SHARK provides fault information for include, the motors, the park brakes, the batteries, the cabling and the SHARK modules themselves.

**Note that joystick OPPNAPU (Out Of Neutral At Power Up) is not a fault. Simply by removing your hand from the joystick and allowing it to return to the neutral position, the fault will immediately clear.**

**If the condition persists after removing your hand, the joystick may be damaged. Consult a service agent.**

The nature of the abnormal condition is indicated by a flash code. This is a sequence of flashes, separated by a pause, followed by a repetition of the sequence. The number of flashes relates to the condition. For instance, four flashes of the SHARK Information Gauge, a pause, followed by four flashes, etc. indicates a right motor fault. Five flashes would indicate a left park brake fault.

Depending on the severity of the condition, the powerchair may or may not allow driving. In some cases the chair may be allowed to drive but in a reduced speed ('limp') mode.

## Flash Codes

Flash codes indicate the nature of an abnormal condition directly from the SHARK Information Gauge. Without the use of any servicing tools, the condition can be simply diagnosed.



<b>Flash Code</b>	<b>Description</b>	<b>Remark</b>
<b>1</b>	User Fault	Possible stall timeout user error. Release the joystick to neutral and try again.
<b>2</b>	Battery Fault	Check the batteries and cabling. Try charging the batteries. Batteries may require replacing.
<b>3</b>	Left Motor Fault	Check the left motor, connections and cabling.
<b>4</b>	Right Motor Fault	Check the right motor, connections and cabling.
<b>5</b>	Left Park Brake Fault	Check the left park brake, connections and cabling.
<b>6</b>	Right Park Brake Fault	Check the right park brake, connections and cabling.
<b>7</b>	SHARK Control Unit Fault	Check the SHARK Communications Bus connections and wiring. Replace the Control Unit.
<b>8</b>	SHARK Power Module Fault	Check SHARK connections and wiring. Replace the Power Module.
<b>9</b>	SHARK Communications Fault	Check SHARK connections and wiring. Replace the SHARK Control Unit.
<b>10</b>	Unknown Fault	Check all connections and wiring. Consult a service agent.
<b>11</b>	Incompatible Control Unit	Wrong type of Control Unit connected. Ensure the branding of the Power Module matches that of the Control Unit.

# P301(MP3W) Powerbase Wheelchair

## ■ VR2 Controller Operation:

The VR2 control system has two versions of the front control panel - with and without actuator control. Most of the controls are common to both versions, however, the actuator buttons are only included on VR2 control systems with seat actuator control. Each of the controls is explained within this section.

### VR2 USER CONTROLS

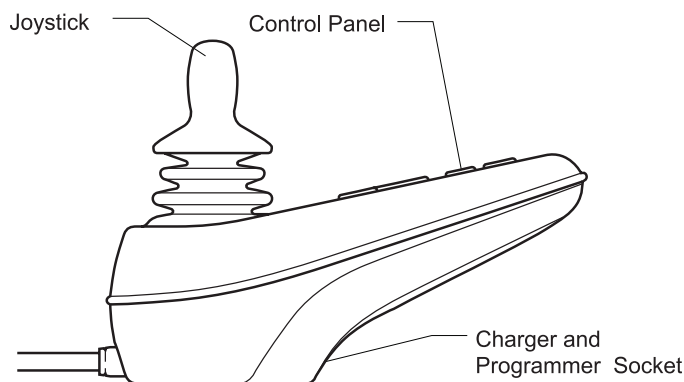

### Front Control Panel Details

No Actuators

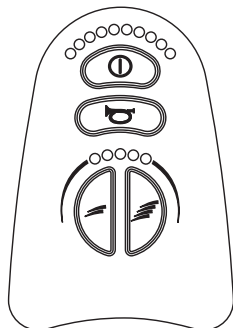

With Actuators

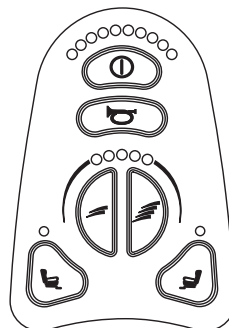

### VR2 CONTROL BUTTONS

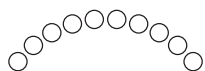

Battery Gauge



On/Off Button



Horn Button

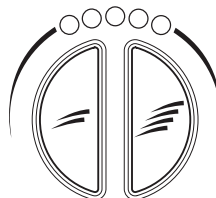

Maximum Speed / Profile Indicator

Speed / Profile Decrease Button

Speed / Profile Increase Button



Actuator Buttons

## On/Off Button and Battery Gauge

The on/off button applies power to the control system electronics, which in turn supply power to the wheelchair's motors. Do not use the on/off button to stop the wheelchair unless there is an emergency. (If you do, you may shorten the life of the wheelchair drive components).

The battery gauge shows you that the wheelchair is switched on. It also indicates the operating status of the wheelchair. Details are given in section 1.

### 1 Control System Status indication

The battery gauge and maximum speed / profile indicator show the status of the control system.

A number of supposedly defective control systems returned to us are subsequently found to operate correctly. This indicates that many reported faults are due to wheelchair problems rather than the control system.

#### 1.1 Battery Gauge is Steady

This indicates that all is well.

#### 1.2 Battery Gauge Flashes Slowly

The control system is functioning correctly, but you should charge the battery as soon as possible.

#### 1.3 Battery Gauge steps Up

The wheelchair batteries are being charged. You will not be able to drive the wheelchair until the charger is disconnected and you have switched the control system off and on again.

#### 1.4 Battery Gauge Flashes Rapidly (even with the joystick released)

The control system safety circuits have operated and the control system has been prevented from moving the wheelchair.

This indicates a system trip, i.e. the VR2 has detected a problem somewhere in the wheelchair's electrical system. Please follow this procedure.

- Switch off the control system.
- Make sure that all connectors on the wheelchair and the control system are mated securely.
- Check the condition of the battery.
- If you can't find the problem, try using the self-help guide given in section 1.6.
- Switch on the control system again and try to drive the wheelchair. If the safety circuits operate again, switch off and do not try to use the wheelchair.

Contact your service agent.

#### 1.5 Self-Help Guide

If a system trip occurs, you can find out what has happened by counting the number of bars on the battery gauge that are flashing.













# P301(MP3W) Powerbase Wheelchair

Below is a list of self-help actions. Try to use this list before you contact your service agent. Go to the number in the list which matches the number of flashing bars and follow the instructions.

If the problem persists after you made the checks described above contact your service agent.

\* If the programmable parameter, Motor Swap has been enabled, then left and right hand references in this table will need transposing.

<b>1 Bar</b> 	The battery needs charging or there is a bad connection to the battery. Check the connections to the battery. If the connections are good, try charging the battery.
<b>2 Bar</b> 	The left hand motor* has a bad connection. Check the connections to the left hand motor.
<b>3 Bar</b> 	The left hand motor* has a short circuit to a battery connection. Contact your service agent.
<b>4 Bar</b> 	The right hand motor* has a bad connection. Check the connections to the right hand module.
<b>5 Bar</b> 	The right hand motor* has a short circuit to a battery connection. Contact your service agent.
<b>6 Bar</b> 	The wheelchair is being prevented from driving by an external signal. The exact cause will depend on the type of wheelchair you have, one possibility is the battery charger is connected.
<b>7 Bar</b> 	A joystick fault is indicated. Make sure that the joystick is in the center position before switching on the control system.
<b>8 Bar</b> 	A control system fault is indicated. Make sure that all connections are secure.
<b>9 Bar</b> 	The parking brakes have a bad connection. Check the parking brake and motor connections. Make sure the control system connections are secure.
<b>10 Bar</b> 	An excessive voltage has been applied to the control system. This is usually caused by a poor battery connection. Check the battery connections.
<b>7 Bar + S</b> 	A communication fault is indicated. Make sure that joystick cable is securely connected and not damaged.
<b>8 Bar + A</b> 	An Actuator trip is indicated. If more than one actuator is fitted, check which actuator is not working correctly. Check the actuator wiring.

### 1.6 Slow or sluggish movement

If the wheelchair does not travel at full speed or does not respond quickly enough, and the battery condition is good, check the maximum speed setting. If adjusting the speed setting does not remedy the problem then there may be a non-hazardous fault.

Contact your service agent

### 1.7 Maximum Speed / Profile Indicator is Steady

The display will vary slightly depending on whether the control system is programmed to operate with drive profiles.

#### 1.7.1 Maximum Speed Indication

The number of LEDs illuminated shows the maximum speed setting. For example, if the setting is speed level 4, then the four left hand LEDs will be illuminated.

#### 1.7.2 Profile Indication

The LED illuminated shows the selected drive profile. For example, if drive profile 4 is selected, then the fourth LED from the left will be illuminated.

### 1.8 Maximum Speed / Profile Indicator Ripples Up and Down

This indicates the control system is locked.

### 1.9 Maximum Speed / Profile Indicator Flashes

This indicates the speed of the wheelchair is being limited for safety reasons. The exact reason will depend on the type of wheelchair, however, the most common cause is that the seat is in the elevated position.

# P301(MP3W) Powerbase Wheelchair

## VR2 POWER MODULE CONNECTIONS

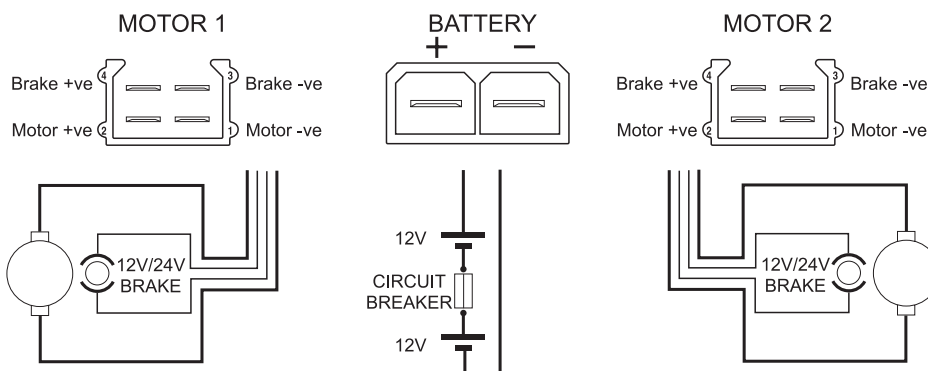
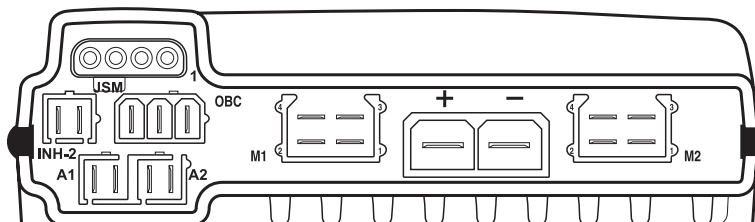

### INHIBIT 2

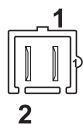

INH-2	Function
1	0V
2	Inhibit 2

### ON-BOARD CHARGER

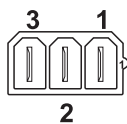

OBC	Function
1	Battery +ve
2	Inhibit 3
3	0V

### ACTUATORS

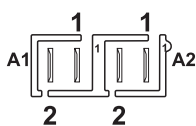

Joystick Movement	Pin 1	Pin 2	Actuator Movement
	Forward	+ve	
Backward	-ve	+ve	Channel Down

## ■ Seat Lift System (Optional)

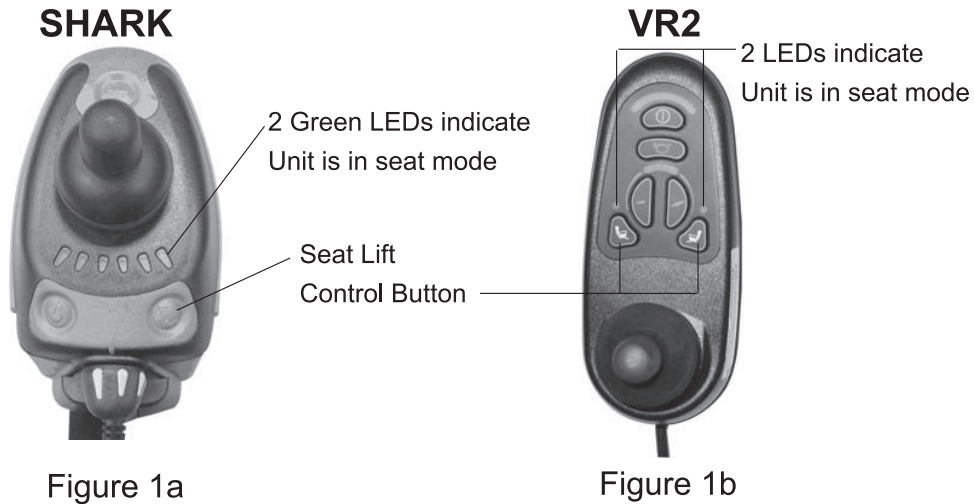

Figure 1a

Figure 1b

### Using the Seat Button

Press the Seat button, shown in Figure 1a, to toggle the control unit between Drive and Seat Modes.

When in Drive Mode, the Battery Gauge displays the current battery capacity and the joystick controls the vehicle movement .

When in Drive Mode:

Figure 1a (SHARK):

The two Green Battery Gauge LEDs next to the Seat button light to indicate the control unit is in Seat Mode (See photo). Moving joystick now controls the seat lift function.

Figure 1b (VR2):

The two LEDs next to the seat button light to indicate the control unit is in Seat Mode (See photo). Moving joystick now controls the seat lift function.

Press the seat button again to toggle from the Seat mode back to the Drive Mode.

### Safety Considerations

Do not move the power chair if the seat is not in the lowest position.

### **WARNING!**

Do not move the power chair unless the seat is in the lowest position.

## ■ Push your Powerbase Wheelchair

1. There is a freewheel lever attached to the two motors, which allow you to choose between power drive and manual assist mode.
2. This mode uses wheel-clutches that disconnect the wheel (s) from the drive train. If you require the wheelchair to be pushed, turn the wheel-clutch levers (that protrude through the top cover) through 90 degrees such that the top of each lever points toward the wheel.
3. When the freewheel lever is at the disengaged position, the Powerbase Wheelchair can be manually pushed by an attendant.
4. Switch off the controllers power and it will be easier to push the wheelchair.

## ■ Batteries and Charging

Your Power Wheelchair uses two long-lasting, 12-volt batteries. These batteries are sealed, maintenance free, deep-cycle batteries. Since they are sealed, there is no need to check the electrolyte (fluid) level. Deep-cycle batteries are designed to handle a deep discharge. Though they are similar in appearance to automotive batteries, they are not interchangeable. Automotive batteries are not designed to handle a long, deep discharge, and are also unsafe for use in power wheelchairs.



**WARNING!** Battery posts, terminals and related accessories contain lead and lead compounds. Wash hands after handling.

### **BATTERY BREAK-IN**

To break in your power wheelchair new batteries for maximum efficiency:

1. Fully recharge any new battery prior to initial use. This will bring the battery up to about 90% of its peak performance level.
2. Run your power wheelchair about the house and yard. Move slowly at first, and do not stray too far until you become accustomed to the controls and break in the batteries.
3. Give the batteries another full charge of 8 to 14 hours and operate the power wheelchair again. The batteries should now perform at over 90% of their potential.
4. After four or five charging cycles, the batteries will top off at 100% charge and last for an extended period.

### **IMPORTANT INFORMATION ABOUT BATTERIES**

A fully charged deep-cycle battery provides reliable performance and extended battery life. Keep your batteries fully charged whenever possible. Batteries that are regularly discharged, infrequently charged, or stored without a full charge may be permanently damaged, causing unreliable operation and limited battery life.

If you do not use your power wheelchair regularly, we recommend maintaining battery vitality by charging the batteries at least once a week.

Note: If you are storing a power wheelchair for an extended period of time, you may wish to block the unit up off the ground with several boards under the frame. This keeps the tires off the ground and prevent the possibility of flat spots developing.

If you intend to use public transportation while using your power wheelchair, you must contact in advance the transportation provider to determine their specific requirements.

## Batteries and Charging

Sealed Lead Acid and Gel Cell batteries are designed for application in wheelchairs and in other mobility vehicles. Generally, Sealed Lead Acid batteries that are marked as "Non-Spill" are safe for all forms of transportation such as aircraft, buses, and trains. We suggest that you contact your transportation provider to determine specific requirements of transportation and packaging.

If you wish to use a freight company to ship the power wheelchair to your final destination, repack the power wheelchair in the original shipping container and ship its batteries in separate boxes.

### Charging Your Batteries

The battery charger is one of the most important parts of your power wheelchair. Optimize your power wheelchair performance by charging the batteries safely, quickly, and easily. Use only the charger supplied with the vehicle.

### Charging Procedures

1. Keep charger output plug inserted into the charging socket in the front of the controller before having the charger input plugged into an electrical outlet.
2. Follow the instructions on the front panel of the charger for operating and learn the meanings of the different indicators accordingly.
3. Minimum charging time varies depending on battery condition and discharge level. It is recommended to charge the batteries overnight.

NOTE: The specially designed charger assures that excess power is not consumed regardless of how long it is switched on, and connected to the batteries.

4. Once charging is complete, disconnect the charger from the electrical outlet and then disconnect the charger from the controller socket. Do not leave the charger connected to controller when input power is disconnected.

## Batteries and Charging



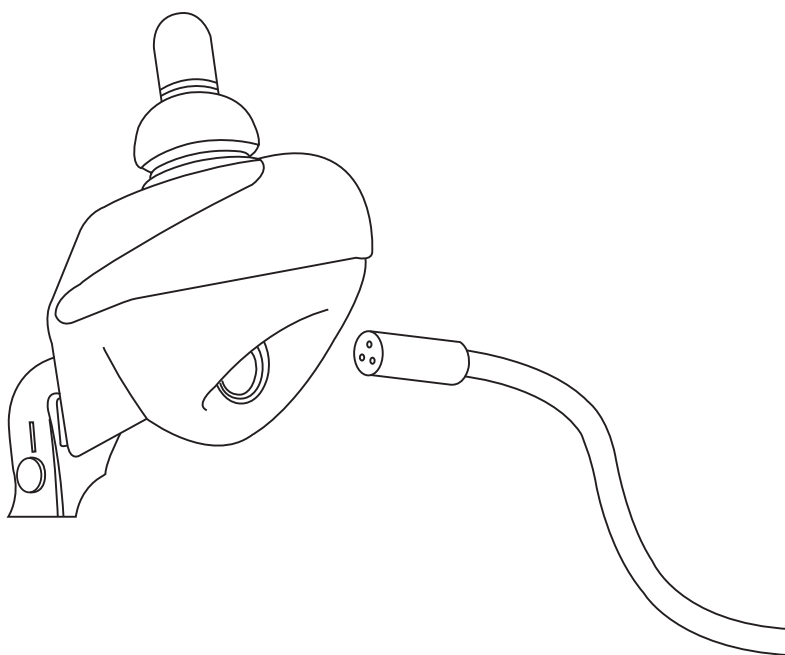

For replacement batteries, contact your dealer.



**WARNING:** Do not exceed the maximum charging current of 12 A rms. Always use an off-board charger fitted with a Neutrik NC3MX plug. Failure to observe these conditions could result in poor contact resistance in the charger connector resulting in overheating of the charger plugs. This presents a potential burn hazard for the user. Penny & Giles accepts no liability for losses of any kind arising from the failure to comply with this condition.



# P301(MP3W) Powerbase Wheelchair

IEC SYMBOLS	
	Caution, attention or consult accompanying documents.
	Alternating Current
	Type BF Equipment
	Double Insulation
	No Smoking or Naked Flames

Degree of protection against ingress of water is rated as IPx0.

Serialization format for products	
	
1	The first digit is the last one digit of the year for manufacture.
2	The second and third digits are the month for manufacture.
3	The fourth to seventh digits are counting of how many units were manufactured during the month.

## ■ Merits Limited Warranty

Merits Corporation warrants to the original purchaser of this wheelchair product that it is free of defect in material and workmanship and that, when operated within the guidelines and restrictions of this manual, will remain so free of defect in material and workmanship for a period of One (1) year from the original date of purchase.

Excluded from this warranty is failure due to negligence, abuse, accident, operation outside of rated limits, commercial or institutional use, damage / wear to upholstery or tires and improper maintenance or storage. The batteries for this wheelchair product are not supplied by Merits Corporation; contact the battery manufacturer / supplier if warranty replacement is requested.

This wheelchair product must not be modified in any way without the express written consent of Merits Corporation. Any such unauthorized modification could cause unreliable and / or unsafe operation and will void this warranty.

Where a failure occurs within the 1- year warranty period that is not excluded above, the failed components will be replaced with similar new or reconditioned components at Merits sole option. Merits Corporation will not be responsible for labor and / or shipping charges.

The foregoing warranty is exclusive and in lieu of all other warranties expressed or implied including, but not limited to, the implied warranty of merchantability and fitness for a particular purpose. Merits Corporation will not be liable for any consequential or incidental damages whatsoever.

# P301(MP3W) Powerbase Wheelchair

**Warranty**

## WARRANTY REGISTRATION

MODEL NO. \_\_\_\_\_

SERIAL NO. \_\_\_\_\_

DATE PURCHASED \_\_\_\_\_

NAME \_\_\_\_\_

ADDRESS \_\_\_\_\_

CITY \_\_\_\_\_ STATE \_\_\_\_\_ ZIP \_\_\_\_\_

DEALER NAME \_\_\_\_\_

STAMP

RETURN ADDRESS

\_\_\_\_\_

\_\_\_\_\_

\_\_\_\_\_

# P301(MP3W) Powerbase Wheelchair

We wish you a safe and comfortable riding experience!

