

XC Hybrid

For use with XCH Plastic, XCH Stainless Steel,
and XCH Solar Panel controllers

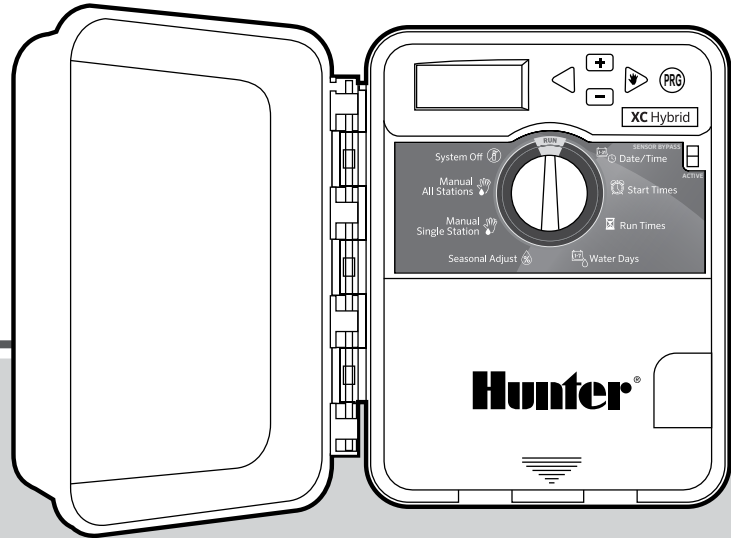

Owner's Manual and
Installation Instructions

Hunter[®]

TABLE OF CONTENTS

INTRODUCTION	1	Automatic Watering	14
XC HYBRID COMPONENTS	2	System Off	14
MOUNTING THE CONTROLLER TO THE WALL	5	Programmable Rain Off	14
CONNECTING VALVES	5	Seasonal Adjustment	14
INSTALLING BATTERIES	6	Manually Run a Single Station	15
CONNECTING A MASTER VALVE	7	Manually Run All Stations	15
CONNECTING A WEATHER SENSOR	8	One Touch Manual Start and Advance	15
Testing the Weather Sensor	8	ADVANCED FEATURES	16
Manually Bypassing the Weather Sensor	8	Programmable Sensor Override	16
POWER FAILURES	9	Test Program of All Stations	16
INSTALLING THE TRANSFORMER (OPTIONAL)	9	Easy Retrieve™ Program Memory	17
WATERING SCHEDULE	10	Programmable Delay Between Stations	17
PROGRAMMING THE CONTROLLER	11	Clearing the Controller's Memory/ Resetting the Controller	17
Setting the Date and Time	11	POLE MOUNT INSTRUCTIONS	18
Setting the Program Start Time(s)	11	TROUBLESHOOTING GUIDE	20
Eliminating a Program Start Time	12	SPECIFICATIONS	21
Setting Station Run Times	12	Operating Specifications	21
Setting Days To Water	12	ELECTRICAL SPECIFICATIONS	21
Selecting Specific Days of the Week to Water	12	Explanation of Symbols	21
Selecting Odd or Even Days to Water	13	CERTIFICATE OF CONFORMITY TO EUROPEAN DIRECTIVES	22
Selecting Interval Watering	13		
Setting Event Day(s) Off	13		

INTRODUCTION

The XC Hybrid is a full-featured irrigation controller that combines maximum programming flexibility with the versatility of battery operation for a wide range of installations. Using DC latching solenoid technology, the XCH is ideal for remote or isolated installations that do not have access to AC power. The XCH is truly a hybrid controller that can operate from a wide variety of power sources. In situations where AC power is available, a plug-in transformer can be used to supply power to the controller. A factory-installed solar panel version (XCH-XXX-SSP) allows for a continuous supply of power to the controller without the need for replaceable batteries.

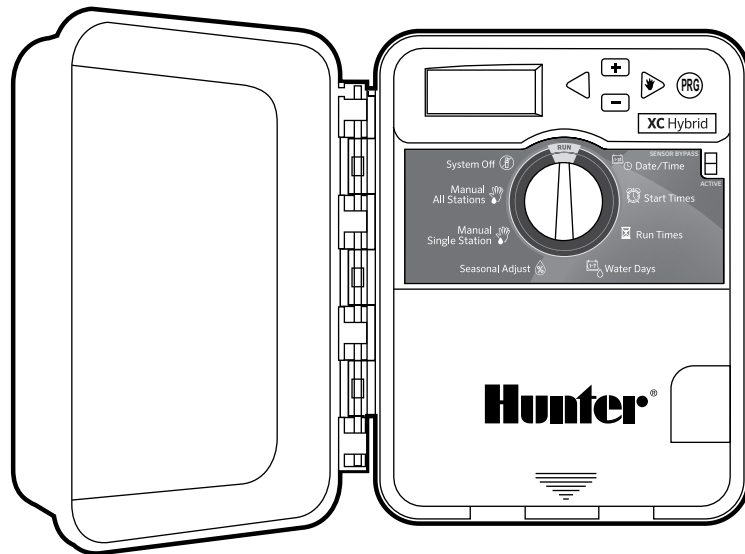

XC HYBRID COMPONENTS



STAINLESS STEEL VERSION





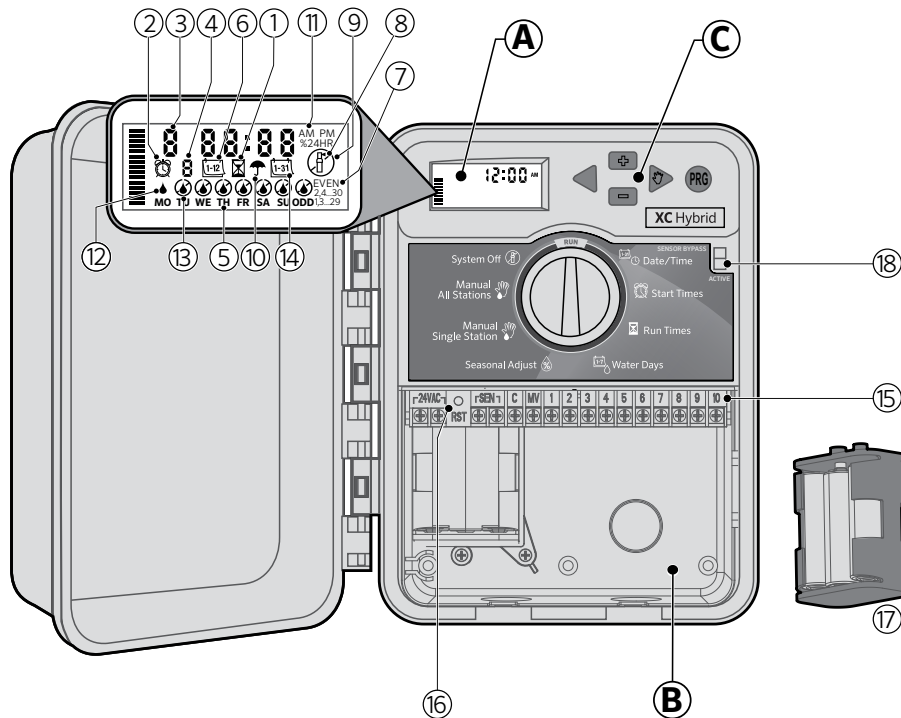





STAINLESS STEEL SOLAR
VERSION



PLASTIC VERSION

A – LCD DISPLAY





1.  **Run Times** – Allows user to set each valve station run time from 1 minute to 4 hours.
2.  **Start Times** – Allows 1 to 4 start times to be set in each program.
3. **Station Number** – Indicates currently selected station number.
4. **Program Designator** – Identifies program (A, B, or C) in use.
5. **Day of the Week** – Identifies day of the week.
6.  **Interval Watering** – Identifies month when programming current date.
7. **Odd/Even Watering** – Identifies if Odd or Even watering has been selected.
8. **Flashing Sprinkler** – Indicates that watering is taking place.
9.  **System Off** – Allows user to discontinue all programs and watering. Also allows the user to set the programmable "rain off," which stops watering for a period from 1 to 7 days.
10.  **Umbrella** – Indicates that the rain sensor is active.
11. **% Seasonal Adjustment** – Allows the user to make run time changes according to the seasons without reprogramming the controller. Bars on the left allow quick visual reference to the seasonal adjustment percentage.

12.  **Rain Drop** – Indicates watering will occur on the selected day.
13.  **Crossed Rain Drop** – Indicates the watering will NOT occur on the selected day.
14.  **Calendar** – Indicates interval watering schedule has been programmed. Icon also appears when programming the current day.

B – WIRING COMPARTMENT

15. **Terminal Strip** – Use to attach transformer, sensor, and valve wires from their source to the controller.
16. **Reset Button** – Use to reset the controller.
17. **Battery Holder** – Holds six AA alkaline batteries.

C – CONTROL BUTTONS

-  Button – Increases the selected item flashing in the display.
 -  Button – Decreases the selected item flashing in the display.
 -  Button – Returns selected flashing display to previous item.
 -  Button – Advances the selected flashing display to the next item.
 -  Button – Selects program A, B, or C for different watering zone requirements.
18. **Sensor Bypass Switch.**

XC HYBRID COMPONENTS CONTINUED

D – DIAL SETTINGS

Run – Normal dial position for all controller automatic and manual operation.

 **Current Time/Day** – Allows current day and clock time to be set.

 **Start Times** – Allows 1 to 4 start times to be set in each program.

 **Run Times** – Allows user to set each valve station run time from 1 minute to 4 hours.

 **Water Days** – Allows the user to select interval days to water.

% Seasonal Adjustment – Allows user to make run time changes according to the seasons without reprogramming the controller. Bars on the left allow quick visual reference to the seasonal adjustment percentage.

 **Manual-One Station** – Allows user to activate a one-time watering of a single valve.

 **Manual-All Stations** – Allows user to activate a one-time watering of all valve stations or a few selected stations.

 **System Off** – Allows user to discontinue all programs and watering. Also allows the user to set the programmable rain off, which stops watering for a period from 1 to 7 days.

E – EXTERNAL TRANSFORMER (OPTIONAL)

A plug-in transformer can be used to supply AC power to the controller.

MOUNTING THE CONTROLLER TO THE WALL

1. Secure one screw into the wall. Install screw anchors if attaching to drywall or masonry wall.
2. Slide the keyhole on top of the controller over the screw.
3. Secure the controller in place by installing screws in the holes below the terminal strip.

WIRE SIZE	DISTANCE FROM VALVE TO CONTROLLER
18 AWG (0.8 mm ²)	550' (168 m)
16 AWG (1.3 mm ²)	870' (265 m)
14 AWG (2.1 mm ²)	1,380' (421 m)
12 AWG (3.3 mm ²)	2,200' (671 m)

CONNECTING VALVES



NOTE: The XCH operates DC latching solenoids only (order Hunter P/N: 458200). 24 VAC solenoids will NOT operate with the XCH. DC solenoids can be easily identified by red and black leads. The red lead is attached to the station output, while the black lead is attached to the common wire.

1. Route valve wires between the control valve location and controller.
2. At valves, attach a common wire to the black solenoid wire on all valves. Attach a separate control wire to the remaining red wire of each valve. All wire connections should be done using waterproof connectors.
3. Route the valve wires through the conduit. Attach the conduit through the bottom right side of the controller.
4. Secure the valve common wire to the C (Common) screw on the terminal strip. Attach each of the individual valve control wires to the appropriate station terminals and tighten their screws.

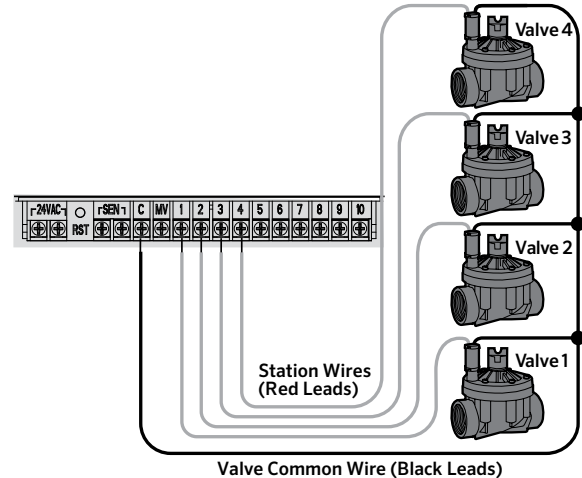

INSTALLING BATTERIES

Battery Power

The XC Hybrid Plastic operates on six AA **alkaline** batteries, and the XC Hybrid Stainless uses six alkaline C batteries. A battery carrier is supplied with your controller. Insert the batteries as indicated on the battery carrier.

- **XC Hybrid-Plastic Battery Install** Connect the battery connector inside the access compartment to the battery carrier and insert the carrier into the lower left side of the controller as shown.
- To access battery carrier on the **XC Hybrid Stainless**, remove the screw in the top center of the controller and swing the facepack down as shown.
- **XC Hybrid Stainless Steel Solar** comes out-of-the-box ready to install and program. Place the controller in full sunlight. Turn the dial to the Run position to activate solar charging.

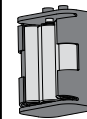
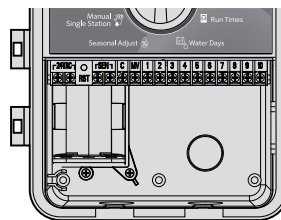

Battery Carrier

XC Hybrid-Plastic

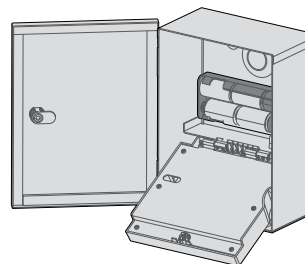

XC Hybrid Stainless

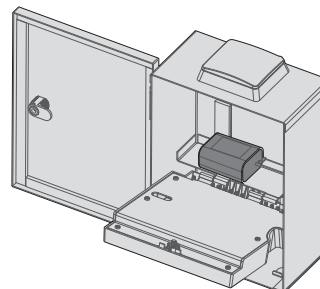

XC Hybrid Stainless Steel Solar

CONNECTING A MASTER VALVE



NOTE: Complete this section only if you have a master valve installed in your irrigation system. A master valve is a “normally closed” valve installed at the supply point of the main line that opens only when the controller initiates a watering program.

1. At the Master Valve, attach the common wire to the black solenoid wire of the valve. Attach a separate control wire to the remaining red solenoid wire.
2. The common wire should be attached to the **C** terminal inside the controller. The other wire coming from the master valve should be attached to the **MV** terminal inside the controller. Tighten each terminal screw.

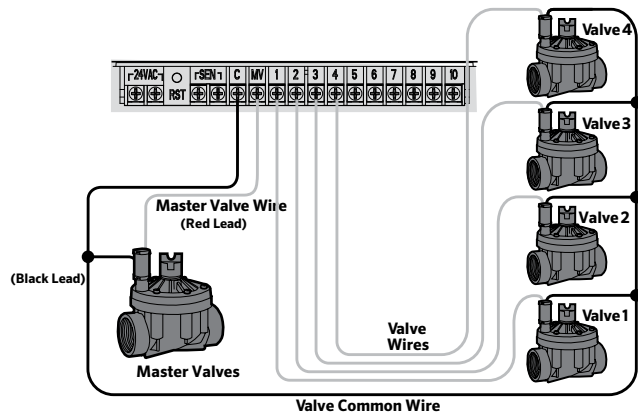

CONNECTING A WEATHER SENSOR

A Hunter weather sensor or other micro-switch-type weather sensors can be connected to the controller. The purpose of this sensor is to stop automatic watering when weather conditions dictate. WRC (Wireless Rain-Clik[®]) is not compatible with XC Hybrid.

1. **Remove the metal jumper plate** that is attached across the two SEN terminals inside the controller.
2. Connect one wire to one SEN terminal and the other wire to the other SEN terminal.

Mini-Clik Rain Sensor

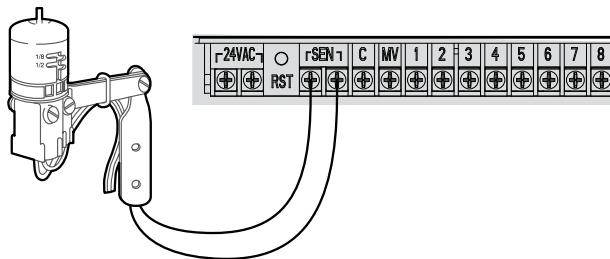

When the weather sensor has deactivated automatic watering, the OFF, and ☂ icon will appear on the display.

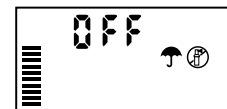

Testing the Weather Sensor

The XC Hybrid provides simplified testing of a rain sensor when the sensor is wired into the sensor circuit. You can manually test proper operation of the rain sensor by running a **MANUAL ALL STATIONS** cycle or by activating the system using the **ONE TOUCH MANUAL START** (see page 15). During the Manual cycle, pressing the test button on the Mini-Clik[®] will interrupt watering.



Manually Bypassing the Weather Sensor

If the rain sensor is interrupting irrigation you can bypass it by using the bypass switch on the front of the controller. Slide the switch to the **SENSOR BYPASS** position to disable the rain sensor from the system to allow for controller operation. You can also bypass the weather sensor for manual operation by using the **MANUAL - ONE STATION** function.

POWER FAILURES

The controller has non-volatile memory. Programmed information will never be lost due to a power outage (when using AC power) or if the AA alkaline batteries go dead.

IN / OUT	VERSION	CATALOG NUMBER
120/24 VAC	U.S.	526500
230/24 VAC	European	545700
240/24 VAC	Australian	545500

INSTALLING THE TRANSFORMER (OPTIONAL)

The XC Hybrid is designed to operate on batteries or a permanent plug-in transformer, if AC power is available. If AC power is available. A 24 VAC output plug-in transformer can be attached to the two 24 VAC terminals inside the lower access area.

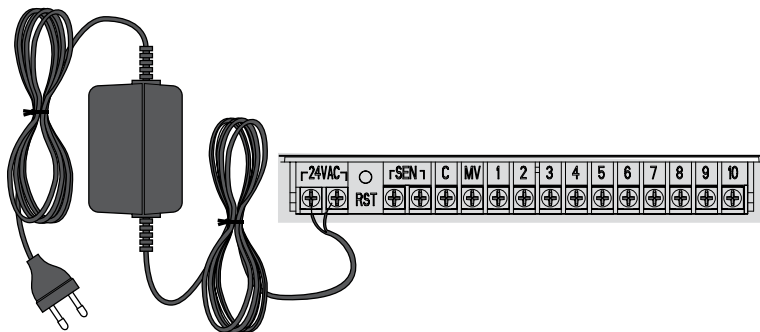

WATERING SCHEDULE

HUNTER XC Hybrid		PROGRAM A							PROGRAM B							PROGRAM C							
DAY OF THE WEEK		MO	TU	WE	TH	FR	SA	SU	MO	TU	WE	TH	FR	SA	SU	MO	TU	WE	TH	FR	SA	SU	
ODD/EVEN OR INTERVAL																							
PROGRAM START TIMES		1																					
		2																					
		3																					
		4																					
STATION	LOCATION	STATION RUN TIME							STATION RUN TIME							STATION RUN TIME							
1																							
2																							
3																							
4																							
5																							
6																							
7																							
8																							
9																							
10																							
11																							
12																							
NOTES:																							

PROGRAMMING THE CONTROLLER

The XC Hybrid display shows the time and day when the controller is idle. The display changes when the dial is rotated to indicate the specific programming information to enter. When programming, the flashing portion of the display can be changed by pressing the **+** or **-** buttons. To change something that is not flashing, press the **◀** or **▶** buttons until the desired field is flashing.

Three programs (A, B, and C — each with the ability to have four daily start times) permit plants with different watering requirements to be separated on different day schedules.



NOTE: A basic programming rule is that whatever symbol or character is flashing will be the item programmed. For instance, if the hour is flashing when setting the time, the hour can be changed or programmed. For illustration purposes in this manual, flashing characters are in GRAY type.

Setting the Date and Time 🕒

1. Turn the dial to the **CURRENT TIME/DAY** position.



2. The current year will be flashing. Use the **+** or **-** buttons to change the year. After setting the year, press the **▶** button to proceed to setting the month.



3. The month and day will be in the display. The month will be flashing and the **1-12** icon will be displayed. Use the **+** or **-** buttons to change the month. Press the **▶** button to proceed to setting the day.

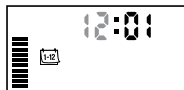

4. The day will be flashing and the **1-31** icon will be displayed. Use the **+** or **-** buttons to change the day. Press the **▶** button to proceed to setting the time.

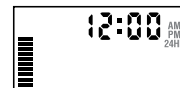

5. The time will be displayed. Use the **+** and **-** buttons to select AM, PM, or 24 hour. Press the **▶** button to move to hours. Hours will be flashing. Use the **+** and **-** buttons to change the hour shown on the display. Press the **▶** button to move to minute. Minutes will be flashing. Use the **+** and **-** buttons to change the minutes shown on the display. The date, day, and time have now been set.



Setting the Program Start Time(s) 🕒

1. Turn the dial to the **START TIMES** position.

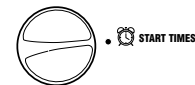

2. The factory preset is set on program A. If necessary, you can select program B or C by pressing the **PROG** button.

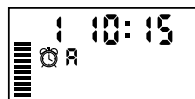

3. Use the **+** or **-** button to change the start time. (The start times advance in 15-minute increments).

4. Press the **▶** button to add an additional start time, or **PROG** button for the next program.

PROGRAMMING THE CONTROLLER



NOTE: One start time will activate all stations sequentially in that program. This eliminates the need to enter each station's start time. Multiple start times in a program can be used for separate morning, afternoon, or evening watering cycles. Start times may be entered in any order. The XC Hybrid will automatically sort them.

Eliminating a Program Start Time

With the dial set to the **START TIMES** position, push the **+** or **-** button until you reach 12:00 AM (midnight). From here, push the **OFF** button once to reach the OFF position.







Setting Station Run Times

1. Turn the dial to the **RUN TIMES** position.
2. The display will show the last program selected (A, B, or C), the station number selected,  icon, and the station will be flashing. You can switch to another program by pressing the **PRG** button.
3. Use the **+** or **-** button to change the station run time on the display. You can set the run times from 0 to 4 hours.
4. Press the **▶** button to advance to the next station.





Setting Days To Water

1. Turn the dial to the **WATER DAYS** position.
2. The display will show the last program selected (A, B, or C). You can switch to another program by pressing the **PRG** button.
3. The controller will display the seven days of the week (MO, TU, WE, TH, FR, SA, SU). Each day will have a  icon or a  icon above the day. The  icon would represent an "On" water day, while a  icon would represent an "Off" watering day.



Selecting Specific Days of the Week to Water



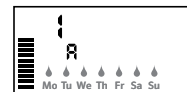



1. With the  cursor on a specific day (the cursor will always start with MO), press the **+** button to activate a particular day of the week to water. Press the **-** button to cancel watering for that day. After pressing a button the cursor automatically advances to the next day.
2. Repeat step 1 until all desired days have been selected. The selected days will show a  to indicate their status is ON. The last  is the last day of watering for that program.



PROGRAMMING THE CONTROLLER

Selecting Odd or Even Days to Water

This feature uses numbered day(s) of the month for watering instead of specific days of the week (odd days: 1st, 3rd, 5th, etc.; even days: 2nd, 4th, 6th, etc.).

1. With the  cursor on Su, press the  button once. The  icon and odd will be displayed.
2. If odd day watering is desired, turn the dial back to the run position.
3. If even day watering is desired, press the  button once. The  icon and **EVEN** will be displayed. You can move back and forth from **ODD** to **EVEN** by pressing the  and  buttons.

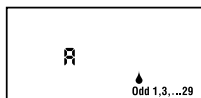

Odd Day Watering







Even Day Watering



NOTE: The 31st of any month and February 29th are always "off" days if Odd watering is selected.

Selecting Interval Watering

With this option you can select interval watering from 1 to 31 days.



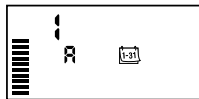

1. With the cursor on **EVEN**, press the  button once and the  icon will appear and a 1 flashing in the display. Interval watering schedule appears on the display.
2. Press the  or  button to select the number of days between watering days (from 1 to 31 days). This is called the interval.



The controller will water the selected program at the next start time and will then water at the interval programmed.

Setting Event Day(s) Off

The XC allows you to program a No Water Day(s). This feature is useful to inhibit watering on specific day(s). For example, if you always mow the lawn on Saturdays, you would designate Saturday as a **No Water Day** so that you are not mowing wet grass.

1. Turn the dial to the **WATER DAYS** position.
2. Enter an interval watering schedule as described previously on this page.
3. Press the  button to scroll to the **NO WATER DAYS** at the bottom of the display. **MO** will be flashing.
4. Use the  button until the cursor is at the day of the week you wish to set as a No Water Day.
5. Press the  button to set this day as a no water day. The  will illuminate over this day.
6. Repeat steps 4 and 5 until all desired event day(s) are off.



NOTE: You also have the option in the interval watering schedule to program Odd or Even days off.

PROGRAMMING THE CONTROLLER

Automatic Watering

After programming, set the dial to the **RUN** position to enable automatic execution of all selected watering programs and start times.

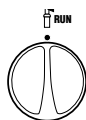

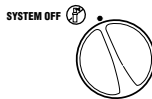

System Off

Valves currently watering will be shut off after the dial is turned to the **SYSTEM OFF** position for two seconds. All active programs are discontinued and watering is stopped. To return the controller to normal automatic operation, simply return the dial to the **RUN** position.



Programmable Rain Off

This feature permits the user to stop all programmed waterings for a designated period from 1 to 7 days. At the end of the programmed rain off period, the controller will resume normal automatic operation.

1. Turn the dial to the **SYSTEM OFF** position. Wait for **OFF 1** to be displayed.
2. Press the  button as many times as needed to set the number of days off (up to 7 days).
3. Turn the dial back to the **RUN** position at which **OFF, a number**, the  and  icons will be displayed.

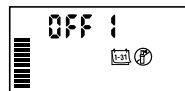
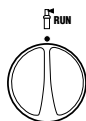
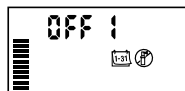
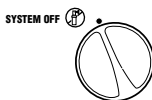



The days off remaining will decrease at midnight each day. When it goes to zero,

the display will show normal time of day and normal irrigation will resume at the next scheduled start time.

Seasonal Adjustment %

Seasonal Adjust is used to make global run time changes without re-programming the entire controller. To use the seasonal adjustment feature:

1. Turn the dial to the **SEASONAL ADJUSTMENT** position.
2. The display will now show a flashing number followed by a %, as well as the bar graph which always remains on the display. Press the  or  button to adjust the percentage of the seasonal adjustment. Each bar on the graph represents 10%. This feature can adjust the controller from 10% to 150% of the original program.

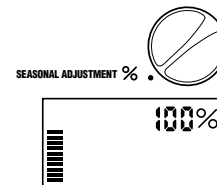



To view the adjusted run times, simply turn the dial to the **RUN TIMES** position. The displayed run time will be updated accordingly as the seasonal adjustment is made.



NOTE: The controller should always be initially programmed in the 100% position.





PROGRAMMING THE CONTROLLER

Manually Run a Single Station

1. Turn the dial to **MANUAL - ONE STATION** position.
2. Station run time will flash in the display. Use the  button to move to the desired station. You may use the  or  button to select the amount of time for a station to water.
3. Turn the dial clockwise to the **RUN** position to run the station (only the designated station will water, then the controller will return to automatic mode with no change to the previously set program). Also see **One Touch Start and Advance**.



Manually Run All Stations









1. Turn dial to **MANUAL - ALL STATIONS** position.
2. Select program A, B, or C by pressing the  button.
3. Station run time will flash in the display. Use the  or  button to select the amount of time for a station to water if different from the run time displayed.
4. Use the  button to move to the next station.
5. Repeat steps 3 and 4 to customize each station.
6. Press the  button until you reach the station at which you would like watering to begin.



Turn the dial clockwise to the **RUN** position (the controller will water the entire program beginning with the station number last left in the display, then return to the automatic mode with no change in the previously set program).

One Touch Manual Start and Advance

You can also activate all stations to water without using the dial.







1. Hold down the  button for 2 seconds.
2. This feature automatically defaults to program A. You can select program B or C by pressing the  button.
3. The station number will be flashing. Press the  button to scroll through the stations and use the  or  button to adjust station run times. (If no buttons are pressed for a few seconds during step 2 or 3, the controller will automatically begin watering).
4. Press the  button scroll to the station you wish to begin with. After a 2-second pause, the program will begin. At any time during the manual cycle, you can use the  or  buttons to navigate from station to station manually.

ADVANCED FEATURES

Programmable Sensor Override

The XC Hybrid allows the user to program the controller so that the sensor disables watering on only desired stations. For example, patio gardens that have pots under overhangs and roofs may not receive water when it rains and will continue to need to be watered during periods of rain.

To program sensor override:

1. Turn the dial to the **RUN** position.
2. Press and hold the  button down while turning the dial to **START TIMES** position.
3. Release the  button. At this point, the display will show the station number, ON, and the  icon, will be flashing.
4. Press the  or  button to enable or disable the sensor for the station shown.
ON = Sensor enabled (will suspend irrigation)
OFF = Sensor disabled (will allow watering)
5. Use the  or  buttons to scroll to the next station that you would like to program the sensor override.

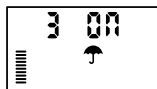
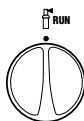

Sensor Enable

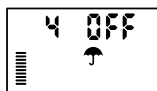



Sensor Disabled



NOTE: The controller default is for the sensor to disable watering on all zones when rain occurs.

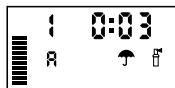

When the XC Hybrid receives an input from the sensor to disable watering, the display will indicate those stations that have been programmed to override the sensor.



A station that is running in the sensor override mode will flash the  and  icons alternately.

Test Program of All Stations

The XC Hybrid allows the user a simplified method for running a test program. This feature will operate each station in numerical sequence, from the lowest to the highest.





1. With the dial in the **RUN** position, press and hold the  button. The station number will be displayed and the time will be flashing.
2. Use the  or  buttons to set the run time from 1 to 15 minutes. The run time needs to be entered only once.
3. After a 2-second pause, the test program will start.

ADVANCED FEATURES





Easy Retrieve™ Program Memory

The XC Hybrid is capable of saving the preferred watering program into memory for retrieval at a later time. This feature allows for a quick way of resetting the controller to the original programmed watering schedule.

To save the program into the memory



1. With the dial in the **RUN** position, press and hold the  and  buttons for 5 seconds. The display will scroll three segments  from left to right across the display indicating the program is being saved into memory.
2. Release the  and  buttons.

To retrieve a program that was previously saved into memory.



1. With the dial in the **RUN** position, press and hold the  and  buttons for 5 seconds. The display will scroll three segments  from right to left across the display indicating the program is being saved into memory.
2. Release the  and  buttons.

Programmable Delay Between Stations

This feature allows the user to insert a delay between stations between when one station turns off and the next one turns on.



1. Start with the dial in the **RUN** position.
2. Press and hold the  button down while turning the dial to the **RUN TIMES** position.
3. Release the  button. At this point the display will show

a delay time for all stations in seconds, which will be flashing.

4. Press the  or  buttons to increase or decrease the delay time between 20 seconds and 4 hours.
5. Return the dial to the **RUN** position.

Clearing the Controller's Memory/ Resetting the Controller

If you feel you have misprogrammed the controller, there is a process that will reset the memory to the factory defaults and erase all programs and data that have been entered into the controller.

1. Press and hold down the  button.
2. Press and release the reset button in the lower wiring compartment.
3. Wait 2 seconds and release the  button. The display should now show 12:00 AM. All the memory has been cleared and the controller may now be reprogrammed.

POLE MOUNT INSTRUCTIONS

Included:

- Six carriage bolts – $\frac{3}{16}$ " (5 mm approx.) diameter
- Six nuts – $\frac{3}{16}$ " (5 mm approx.) diameter

- 1 • Dig a 12" x 12" x 18" (30 x 30 x 45 cm) hole.
• Mix and pour in three 90 lb. (40 kg) bags of cement.

- Make sure the pole is vertical and the opening in the wire sweep is accessible and unclogged.

NOTE: Make sure the cement pad is dry before continuing with the installation.

- 2 • Place the mounting plate on top of the pole.

- Secure the mounting plate with **two carriage bolts** and **two nuts** until the plate does not twist or turn.

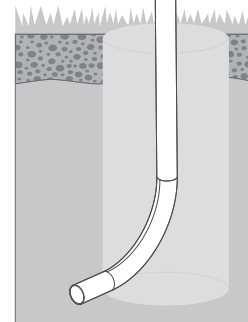
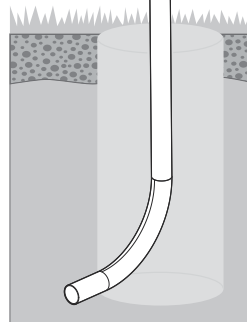
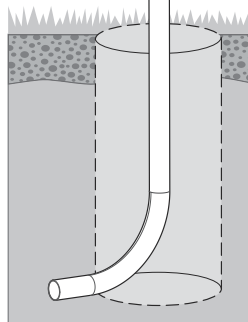
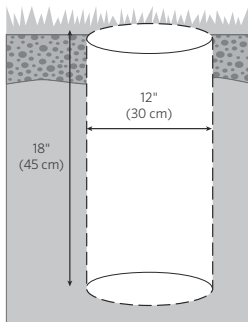

POLE MOUNT INSTRUCTIONS

- 3 • Route all wires up the pole until at least 12" (30 cm) of wire extends out of the top.

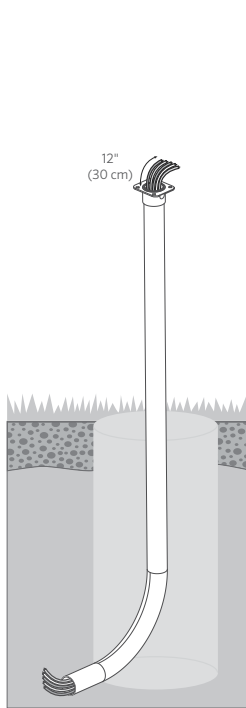

- 4 • Remove the door and bottom facepack cover from the XC Hybrid controller.
 - Place the controller on top of the mounting plate.
 - Remove all four knockouts.

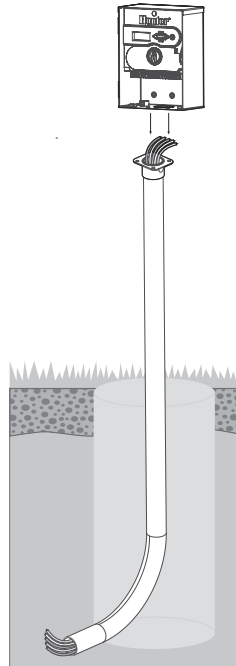



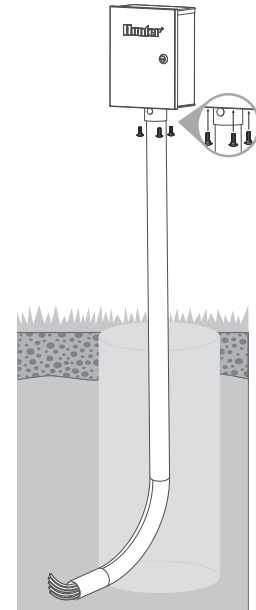

NOTE: Make sure that 12" (30 cm) of wires are now inside the controller and cannot slip back down into the column.

- Insert **four carriage bolts** into the bottom holes located underneath the controller base. Then tighten with **four nuts** until the controller does not twist and cannot be pulled off the mounting plate.
- Replace the facepack cover and the door to the controller.



TROUBLESHOOTING GUIDE

PROBLEM	CAUSES	SOLUTIONS
The controller is continuously watering	Too many start times have been programmed	Only one start time is necessary to activate a program (refer to "Setting the Program Start Time(s)" on page 11)
There is no display	Check batteries or AC power	Correct any errors
Display reads "Off,  	The rain sensor is interrupting irrigation or the sensor jumper has been removed	Slide the rain sensor bypass switch to the BYPASS position to bypass the rain sensor circuit, or reinstall the jumper
Rain sensor will not shut off the system	Defective rain sensor Jumper was not removed when sensor was installed Stations have been programmed to override the sensor	Verify operation of rain sensor and proper wiring Remove jumper from the sensor terminals Reprogram the sensor override to enable the sensor (refer to "Programmable Sensor Override" on page 16)
Frozen display, or showing incorrect information	Power surge	Reset the controller (refer to "Clearing the Controller's Memory/Resetting the Controller" on page 17)
Display shows a station is running but the  and  icons are flashing	The sensor is interrupting irrigation, however the station has been programmed to override the sensor	Check the Programmable Sensor Override status (refer to "Programmable Sensor Override" on page 16)
Automatic irrigation does not start at the start time and controller is not in the System Off mode	AM/PM of time of day not set correctly AM/PM of start time not set correctly Start Time is disabled (set for Off) Batteries are dead Controller is not receiving AC power (if using a transformer)	Correct AM/PM of time of day Correct AM/PM of start time Refer to "Setting the Program Start Time(s)" on page 11 Replace batteries Check AC power connections

SPECIFICATIONS

Operating Specifications

- Station Run Times: 1-minute to 4 hours
- 3 Independent Watering Programs
- Start Times: 4 per day per program for up to 12 daily starts
- Watering Schedule: 365-day calendar, interval watering, odd/even watering
- Interval Day (1 to 31 days)
- AM/PM, 24-hour clock
- Simple manual operation
- Sensor override by station
- Sensor bypass switch
- Programmable rain delay (1 to 7 days)

Electrical Specifications

- Operates DC latching solenoids (only) 9-11 VDC
- Pump/Master Valve
- Electronic short circuit protection
- Six AA (1.5 V) alkaline batteries required (Plastic models)
- Six C (1.5 V) alkaline batteries required (Stainless models)
- One solar panel with an 800 mAh charging cell (Stainless Steel Solar models)
- CE, UL, cUL, C-tick
- Clean only with a cloth dampened with mild soap and water

Explanation of Symbols



= AC



= Consult Documentation



= Ground

CERTIFICATE OF CONFORMITY TO EUROPEAN DIRECTIVES

Hunter Industries declares that the irrigation controller Model XCH complies with the standards of the European Directives of “electromagnetic compatibility” Directive 2014/30/EU and “low voltage” Directive 2014/35/EU.

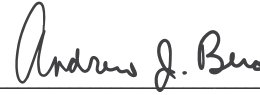

Project Engineer



FCC Notice

This controller generates radio frequency energy and may cause interference to radio and television reception. It has been type tested and found to comply with the limits for a Class B computing device in accordance with the specifications in Subpart J of Part 15 of FCC Rules, which are designed to provide reasonable protection against such interference in a residential installation. However, there is no guarantee that interference will not occur in a particular installation. If this equipment does cause interference to radio or television reception, which can be determined by turning the equipment off and on, the user is encouraged to try to correct the interference by one or more of the following measures:

- Reorient the receiving antenna
- Move the controller away from the receiver
- Plug the controller into a different outlet so that controller and receiver are on different branch circuits

If necessary, the user should consult the dealer or an experienced radio/television technician for additional suggestions. The user may find the following booklet prepared by the Federal Communications Commission helpful: “How to Identify and Resolve Radio-TV Interference Problems.” This booklet is available from the U.S. Government Printing Office, Washington, D.C., Stock No. 004-000-00345-4 (price: \$2.00)

This product should not be used for anything other than what is described in this document. This product should only be serviced by trained and authorized personnel.

Hunter®

RESIDENTIAL & COMMERCIAL IRRIGATION | *Built on Innovation®*

1940 Diamond Street, San Marcos, California 92078, USA

Learn more. Visit hunterindustries.com

© 2018 Hunter Industries Incorporated
LIT-467-EN C 3/18