

英文成册, 材质:封面光面157g铜版纸, 内页普通 80 g书写纸, 尺寸:98×138mm

Distributed by:
Trade Guru Inc.
25 Wellington Ave Apt 2,
Mundelein, IL 60060 US

Designed in USA
Assembled in China

Do you face problems when using your device?
Is the package missing a parts, the device won't start up or is the manual
too difficult to understand?

Don't freak out, stay cool and send email our awesome service hotline!

extracovercare@gmail.com (24/7 at any time!)

Our trained staff will answer all your questions!

Fully Automatic Upper Arm Blood Pressure Monitor

Model Number: C04

USER'S MANUAL



A Special Thank You...

Thank you for choosing a C04 blood pressure instrument. We're proud of the care and quality that goes into the manufacture of each and every item that bears our name. Only the finest materials are used to assure you of a timeless instrument designed for optimum performance. You'll quickly appreciate the results, for you now own one of the finest digital blood pressure instruments that money can buy. With proper care and maintenance, your C04 automatic blood pressure monitor is sure to provide you with many years of dependable service. Please read the following instructions and general information which will prove helpful in allowing you to enjoy your C04 of Digital In hospitals and physician's offices throughout the world, where accuracy and dependability are critical. C04 professional diagnostic products are the instruments of choice.

Now you too can enjoy the benefits of C04 engineering and quality in the home. This feature rich instrument was designed to simplify the measurement of blood pressure and pulse rate at home and deliver consistent, dependable results. Your C04 digital blood pressure monitor is a fully automatic digital blood pressure measuring device for use on the upper arm. It enables very fast and reliable measurement of the systolic and diastolic blood pressure as well as the pulse by way of the oscillometric method. This device offers clinically proven accuracy and has been designed to be user friendly. Read this booklet thoroughly before attempting to use your new C04 Digital Blood Pressure Monitor.

Thank you for your patronage. It is indeed our pleasure to serve you.

Sincerely,
Our team

CONTENTS

1.Introduction and Intended Use.....	3
2.Important Information on Blood Pressure and its Measurement.....	6
3. Components of Your Blood Pressure Monitor.....	8
4. Using Your Monitor for the First Time.....	10
5.Measurement Procedure.....	12
6.Care and Maintenance.....	20
7. Warranty.....	21
8. Certifications.....	21
9. Technical Specifications.....	21
10. EMC Declaration.....	22

1.Introduction and Intended Use

This manual is for C04 models. It is a fully automatic digital blood pressure measuring device for use by adults on the upper arm at home or in your doctor's/nurse's office. It enables very fast and reliable measurement of systolic and diastolic blood pressure as well as pulse through the oscillometric method. This device offers clinically proven accuracy and has been designed to be user friendly.

Before using, please read this instruction manual carefully and then keep it in a safe place. Please contact your doctor for further questions on the subject of blood pressure and its measurement.

Warning: Not suitable for neonatal and infants.

Warning: Not suitable for people who cannot express their ideas correctly.

This device can not be used together with hf surgical equipment.

1.1 Remember...

- Only a health-care professional is qualified to interpret blood pressure measurements.
- This device is NOT intended to replace regular medical checkups.
- It is recommended that your physician review your procedure for using this device.
- Blood pressure readings obtained by this device should be verified before prescribing or making adjustments to any medications used to control hypertension. Under no circumstances should YOU alter the dosages of any drugs prescribed by your doctor.
- This monitor is intended for use by adults only. Consult with a physician before using this instrument on a child.
- In cases of irregular heartbeat, measurements made with this instrument should only be evaluated after consultation with your doctor.
- Familiarize yourself with the section titled "Important Information on Blood Pressure and its Measurement". It contains important information on the dynamics of blood pressure readings and will help you to obtain the best results.
- Host products, including accessories, shall be processed in accordance with local regulations after reaching the life cycle.

NOTE!

- This device contains sensitive electronic components. Avoid strong electrical or electromagnetic fields in the direct vicinity of the device (e.g. mobile telephones, microwave ovens) during use. These can lead to erratic results.
- Do not attempt to service or repair this device yourself. Should a malfunction occur, refer to local distributor or the manufacturer.

Warning :

1. Too frequent measurements can cause injury to the PATIENT due to blood flow interference.
2. Don't place the cuff over wound part.
3. Pressurization of the CUFF can temporarily cause loss of function of simultaneously used monitoring ME EQUIPMENT on the same limb.

Contraindication

Use of this instrument on patients under dialysis therapy or on anticoagulant, antiplatelets, or steroids could cause internal bleeding.

1.2 Warnings and Precautions

Warning: The device contains sensitive electronic components. Avoid strong electrical or electromagnetic fields in the direct vicinity of the device (e.g. mobile telephones, microwave ovens). These can lead to temporary impairment of the measuring accuracy.

Warning: Do not use cuffs, AC adapters or batteries other than those included with this product or replacement parts supplied by the manufacturer.

Warning: Do not use the batteries and the AC adapter to provide power at the same time.

Warning: This system may fail to yield specified measurement accuracy if operated or stored in temperature or humidity conditions outside the limits stated in the specifications section of this manual.

Warning: The separate ac adapter which is intended to connect USB interface of Blood Pressure Monitor has not been evaluated according to IEC 60601-1. The safety of the product shall be reappraised when it power supply by a separate ac adapter.

Warning: Remove the battery if the ME EQUIPMENT is not likely to be used for some time.

Warning: The user must check that the equipment functions safely and see that it is in proper working condition before being used.

Warning: No modification of this equipment is allowed.

Warning: The device is not suitable for use in the presence of flammable anesthetic mixtures with air or with oxygen or nitrous oxide.

Warning: This equipment shall not be serviced or maintained while in use with the patient.

Warning: The patient is an intended operator, the functions of monitoring blood pressure and pulse rate can be safely used by patient. The routine clean and changing batteries can be performed by the patient.

Warning: Use of power adapters
1. Adapter: input 100-240v, 50/60hz output DC 5V 1A
2. Do not position the device to make it difficult to operate the disconnection device while using adaptor.
3. Do not be prone to water leakage, high temperature, moisture, direct sunlight and more or more corrosive gas environment. And Do not use this product in the above environment.

Caution: To avoid any possibility of accidental strangulation, keep this unit away from children and do not drape tubing around your neck.

Caution: To avoid damaging the device, keep this unit away from children and pets.

Caution: The standard material used for the bladder and tubing is latex-free.

Attention: Self-measurement means control, not diagnosis or treatment. Unusual values must always be discussed with your doctor. Under no circumstances should you alter the dosages of any drugs prescribed by your doctor.

Attention: The pulse display is not suitable for checking the frequency of heart pacemakers!

Attention: In cases of irregular heartbeat, measurements made with this instrument should only be evaluated after consultation with your doctor.

Note: To obtain the greatest accuracy from your blood pressure instrument, it is recommended that the instrument be used within the specified temperature and the relative humidity, please see the Technical Specifications.

Note: The cuff is treated as the applied part. The user should contact the manufacturer for assistance, if needed, in setting up, using or maintaining the device.

2.Important Information on Blood Pressure and its Measurement

2.1. How does high or low blood pressure arise?

Your level of blood pressure is determined in the circulatory center of the brain and adjusts to a variety of situations through feedback from the nervous system. To adjust blood pressure, the strength and speed of the heart (Pulse), as well as the width of circulatory blood vessels is altered. Blood vessel width is controlled by fine muscles in the blood vessel walls.

Your level of arterial blood pressure changes periodically during heart activity: During the "blood ejection" (Systole) the value is highest (systolic blood pressure value). At the end of the heart's "rest period" (Diastole) pressure is lowest (diastolic blood pressure value).

Blood pressure values must lie within certain normal ranges in order to prevent particular diseases.

2.2. Which values are normal?

Please refer to the diagram below(Picture-01)

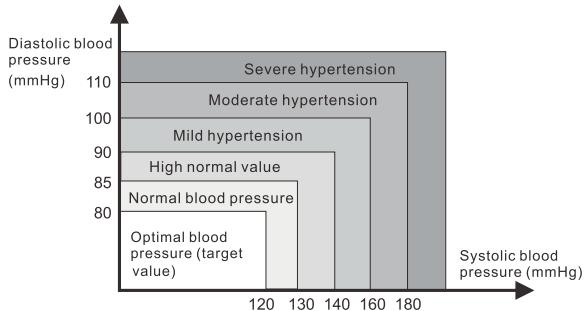

Picture-01

Blood pressure is very high if your diastolic pressure is above 90 mmHg and/or your systolic blood pressure is over 160 mmHg, while at rest. In this case, please consult your physician immediately. Long-term values at this level endanger your health due to continual damage to the blood vessels in your body. If your systolic blood pressure values are between 140 mmHg and 159 mmHg and/or the diastolic blood pressure values between 90 mmHg and 99 mmHg, consult your physician. Regular self-checks are necessary. If you have blood pressure values that are too low, (i.e., systolic values under 90 mmHg and/or diastolic values under 60 mmHg), consult your physician. Even with normal blood pressure values, a regular self-check with your blood pressure monitor is recommended. You can detect possible changes in your values early and react appropriately. If you are undergoing medical treatment to control your blood pressure, keep a record of values along with time of day and date. Show these values to your physician. Never use the results of your measurements to independently alter the drug doses prescribed by your physician.

Further information

- If your values are mostly normal under resting conditions but exceptionally high under conditions of physical or psychological stress, it is possible that you are suffering from so-called "labile hypertension." Consult your doctor.
- Correctly measured diastolic blood pressure values above 120mmHg require immediate medical treatment.

2.3. What can be done if regular high or low values are obtained?

- 1) Consult your doctor.
- 2) Increased blood pressure values (various forms of hypertension) are associated with considerable health risks over time. Arterial blood vessels in your body are endangered due to constriction caused by deposits in the vessel walls (Arteriosclerosis). A deficient supply of blood to important organs (heart, brain, muscles) can result from arteriosclerosis. Furthermore, the heart will become structurally damaged with increased blood pressure values.
- 3) There are many different causes of high blood pressure. We differentiate between the common primary (essential) hypertension, and secondary hypertension. The latter group can be ascribed to specific organ malfunctions. Please consult your doctor for information about the possible origins of your own increased blood pressure values.
- 4) There are measures which you can take to reduce and even prevent high blood pressure.

3. Components of your blood pressure monitor

3.1. Measuring unit

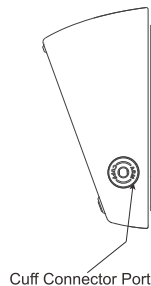

Picture-02

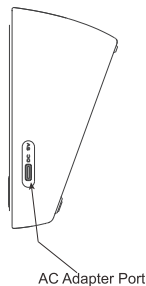

Picture-03

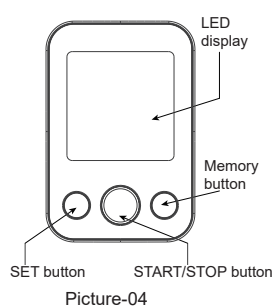

Picture-04

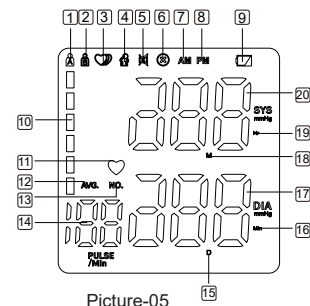

Picture-05

3.2 The symbols on the LED display

- | | |
|---|---------------------------------|
| 1. User A | 2. User B |
| 3. Irregular heartbeat symbol | 4. Movement error symbol |
| 5. Mute symbol | 6. Cuff self-detecting function |
| 7. AM symbol | 8. PM symbol |
| 9. Low battery symbol | 10. WHO function symbol |
| 11. Heartbeat symbol (Flashes during measurement) | 12. Average value symbol |
| 13. NO. symbol | 14. Pulse symbol |
| 16. Minute symbol | 17. Diastolic blood pressure |
| 18. Month symbol | 19. Hour symbol |
| 20. Systolic blood pressure | |

3.3 Features of Model C04

- | | |
|-----------------------------------|--------------------------------------|
| 1. Talking function | 2. Double users: 2 x 120 sets memory |
| 3. Cuff self-checking function | 4. Irregular heartbeat checking |
| 5. Average value function | 6. Low battery display |
| 7. WHO function | 8. Auto power-off |
| 9. External power adapter support | 10. Volume adjustment |
| 11. Time stamp in memory | |

Note: Arm circumference should be measured with a measuring tape in the middle of the relaxed upper arm. Do not force cuff connection into the opening. Make sure the cuff connection is not pushed into the AC adapter port.

4. Using your Monitor for the First Time

4.1 Activating the pre-installed batteries

Battery Installation

Use only 1.5V "AA" alkaline batteries with this device.

1. Press the hook on the bottom of the battery cover and lift the cover off in the direction of the arrow.
2. Install 3 "AA" size batteries so the + (positive) and (negative) polarities match the polarities of the battery compartment, replace the battery cover. Make sure that the battery cover is securely in position.

Battery replacement

Low Battery Indicator

1. When the Low Battery Indicator appears on the display, turn the monitor off and remove all the batteries. Replace with 3 new batteries at the same time. Long-life alkaline batteries are recommended.
2. To prevent the damage of monitor from leaked battery fluid, please take out of battery if the monitor unused in a long time (generally more than 3 months). If battery fluid should get in your eyes, immediately rinse with plenty of clean water. Contact a physician immediately.
3. Attached battery is only for testing the function of the monitor, Long-life alkaline batteries are recommended.
4. Dispose of the device, components and optional accessories according to applicable local regulations. Unlawful disposal may cause environmental pollution
5. Battery is dangerous stuff, do not mix it with other rubbish.

4.2. System Settings

After you load the battery or connect power for the monitor, long press the SET button for more than 3s, and then you can start to set.

Setting the User:

Press the MEM button to select User A or User B. When display A (/B) on the screen, press the MEM button to switch to user B (/A). Press the SET button to confirm.

Setting the Year/Month&Date/Time/Volume:

Long press the SET button for more than 3s, and then you can start to set.

Setting the Year:

Initial year is 2020, when the year display is flashing, press the MEM button, the year will increase by 1 year each, hold the MEM button and it will increase continuously 1 by 1, until 2049, and then rollover to 2020, once the year set is OK, press SET button to confirm.

Setting Month/Date:

Initial Month/Date is 1/01, when the Month display is flashing, press the MEM button, the month will increase by 1, press SET button to confirm, and do in the same way to set the date. Press SET button to confirm.

Setting Time :

When the hour display is flashing, press the MEM button, the hour will increase by 1, press SET button to confirm, and do in the same way to set the minute. Press SET button to confirm.

Setting Volume:

When display with SP is flashing, press MEM button to switch volume 1, volume 2, volume 3 or OFF. Press SET button to confirm.

Record Delete:

When you checking the memory data, long press MEM button to delete existing user measurement data.

Note:

You can't delete all measurement record from the monitor storage at one time, if you decide to delete the all record, please keep the record in another way, in case you need it some days later. Take the battery out won't lead to a record missing.

4.3. Cuff tube connection

Insert the cuff tube into the opening on the left side of the monitor indicated by the drawing of a cuff.

5. Measurement Procedure

Note:

You should always be seated and calm before and during measurement.

5.1. Before measurement:

- Avoid eating and smoking as well as all forms of exertion directly before measurement. These factors influence the measurement result. Find time to relax by sitting in an armchair in a quiet atmosphere for about ten minutes before taking a measurement.
- Remove any garment that fits closely to your upper arm.
- Always measure on the same arm (normally left).
- Always compare measurements taken at the same time of day, since blood pressure changes during the course of the day, as much as 20-40 mmHg.

5.2. Common sources of error:

Note: Comparable blood pressure measurements always require the same conditions!

- Conditions should always be quiet.
 - All efforts by the user to support the arm can increase blood pressure. Make sure you are in a comfortable, relaxed position and do not flex any of the muscles in the measurement arm during the measurement. Use a cushion for support if necessary.
 - If the arm artery lies considerably lower or higher than the heart, an erroneously high or low blood pressure will be measured! Each 25-30cm difference in height between your heart and the cuff results in a measurement error of 10 mmHg!
 - Cuffs that are too narrow or too short result in false measurement values. Selecting the correct cuff is extremely important. Cuff size is dependent upon the circumference of the arm (measured in the center). The permissible range is printed on the cuff.
- Cuff works Under the pressure range 0-300MMHG
The wide range rigid cuff is : 8.7" – 15.7" (22 - 42 cm)

Note: Only use approved cuffs!

- A loose cuff or a sideways protruding air pocket causes false measurement values.
- With repeated measurements, blood accumulates in the arm, which can lead to false results. Consecutive blood pressure measurements should be repeated after a 1 minute pause or after your arm has been held up in order to allow the accumulated blood to flow away. If you decide to take your Averaging Mode measurement again, be sure to wait at least one minute beforehand.

5.3. Fitting the Cuff

Please refer to picture-06

- The cuff is preformed for easier use. Remove tight or bulky clothing from your upper arm.
- Wrap the cuff around your upper left arm. The rubber tube should be on the inside of your arm extending downward to your hand. Make certain the cuff lies approximately 1/2" to 3/4" (1 to 2 cm) above the elbow. Important! The Φ on the edge of the cuff (Artery Mark) must lie over the artery which runs down the inner side of the arm.
- To secure the cuff, wrap it around your arm and press the hook and loop closure together.
- There should be little free space between your arm and the cuff. You should be able to fit 2 fingers between your arm and the cuff. Cuffs that don't fit properly result in false measurement values. Measure your arm circumference if you are not sure of proper fit.
- Lay your arm on a table (palm upward) so the cuff is at the same height as your heart. Make sure the tube is not kinked.
- Remain seated quietly for at least two minutes before you begin the measurement.

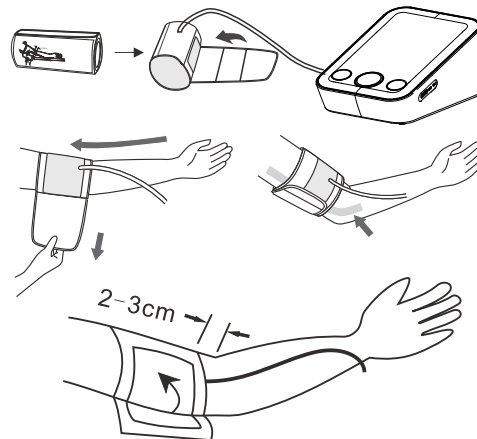

Picture-06

5.4. Measure Procedure

Refer to picture-07

The monitor is designed to take measurements and store the measurement values in memory for two people using User ID A and User ID B.

1. Sit comfortably in a chair with your feet flat on the floor.

2. Select your User ID (A or B).

Stretch your arm forward on the desk and keep relaxing, make sure the palm of hand is upturned. Make sure arm is in correct position, to avoid body movement. Sit still and do not talk or move during the measurement.

After the cuff has been appropriately positioned on the arm and connected to the blood pressure monitor, the measurement can begin:

a) Press the START/STOP button. The pump begins to inflate the cuff. In the display, the increasing cuff pressure is continually displayed.

b) After automatically reaching an individual pressure, the pump stops and the pressure slowly falls. The cuff pressure is displayed during the measurement.

c) When the device has detected your pulse, the heart symbol in the display begins to blink.

d) When the measurement has been concluded, the measured systolic and diastolic blood pressure values, as well as the pulse will be displayed.

e) The appearance of this  symbol signifies that an irregular heartbeat was detected. This indicator is only a caution. It is important that you be relaxed, remain still and do not talk during measurements.

f) The measurement results are displayed until you switch the device off. If no button is pressed for 60 seconds, the device switches off automatically.

g) Cuff self-checking symbol ()

The wrong symbol () will be displayed if the cuff is too loose.

h) Movement error symbol ()

The Movement Error Symbol () is displayed if you move your body during the measurement. Please remove the cuff, and wait 2-3 minutes. Reapply the cuff and take another measurement.

NOTE:

Patient Position:

- 1) Comfortably seated
- 2) Legs uncrossed
- 3) Feet flat on the floor
- 4) Back and arm supported
- 5) Middle of the CUFF at the level of the right atrium of the heart

Recommended Use Methods

1. Recommendation that the PATIENT relax as much as possible and not talk during the measurement PROCEDURE

2. Recommendation that 5 min should elapse before the first reading is taken

3. Any reading can be affected by the measurement site, the position of the PATIENT, exercise, or the PATIENT'S physiologic condition

4. Performance of the AUTOMATED SPHYGMOMANOMETER can be affected by extremes of temperature, humidity and altitude

5. To stop the inflation or measurement, push the START/STOP button. The monitor will stop inflating, start deflating, and will turn off.

6. After the monitor has detected your blood pressure and pulse rate, the cuff automatically deflates. Your blood pressure and pulse rate are displayed.

7. The monitor will automatically turn off after one minute.

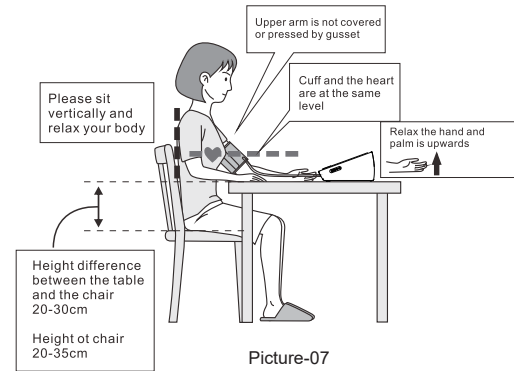

Picture-07

5.5. Irregular Heartbeat Detector

This symbol - indicates that certain pulse irregularities were detected during the measurement.

In this case, the result may deviate from your normal basal blood pressure – repeat the measurement.

Information for the doctor on frequent appearance of the Irregular Heartbeat Symbol.

This instrument is an oscillometric blood pressure monitor device that also analyzes pulse frequency during measurement. The instrument is clinically tested.

If pulse irregularities occur during measurement, the irregular heartbeat symbol is displayed after the measurement. If the symbol appears more frequently (e.g. several times per week on measurements performed daily) or if it suddenly appears more often than usual, we recommend the patient to seek medical advice. The instrument does not replace a cardiac examination, but serves to detect pulse irregularities at an early stage.

5.6. Error Indicates

The following symbol will appear on the display when measuring abnormal





SYMBOL	CAUSE	CORRECTION
No display appears	Weak battery or improper placement	Replace both batteries with new ones. Check the battery installation for proper placement of the battery polarities.
Er 1	Sensor abnormal	Check if the pump is working or not. If it is working, then the problem is sensor abnormal. Please send it to the local distributor.
Er 2	Monitor could not detect pulse wave or cannot calculate the blood pressure data	Check if the air releasing is too slow or not. If it is too slow, please check if there is any dust in the tube plug of the cuff and the cuff port in the device. If yes, please clean and start the measurement again. If no, please send the device back to the local distributor.
Er 3	Measurement result is abnormal (SYS \geq 45mmHg, DIA \geq 24mmHg)	Occasionally-measure for one more time/ Always - send it to local distributor
Er 4	Too loose cuff or air leakage (Cannot inflate to 30mmHg within 15s)	Tie the cuff correctly and make sure the air plug is properly inserted in the unit
Er 5	The air tube is crimped	Correct it and make the measurement again
Er 6	The sensor is sensing great fluctuation in the pressure	Please keep quiet and don't move
Er 7	The pressure that the sensor sensing is over the limit	Please send back to the local distributor
Er 8	The demarcation is incorrect or the device has not been demarcated	Please send back to the local distributor







Trouble removal

Problem	Check	Cause and solutions
No power	Check the battery power	Replace new one
	Check the polarity position	Installation for proper placement of the batteries polarities
No inflation	Whether the plug insert	Insert into the air socket tightly
	Whether the plug broken or leak	Change a new cuff
Err and stop working	Whether move the arm when inflate	Keep the body peaceful
	Check if chatting when measured	Keep quite when measure
Cuff leak	Whether the cuff wrap too loose	Wrap the cuff tightly
	Whether the cuff is broken	Change a new cuff
 Please contact the distributor if you can't solve the problem, do not disassemble the unit by yourself!		

SYMBOL DESCRIPTIONS

The following symbols may appear in this manual, on the Digital Blood Pressure Monitor C04, or on it's accessories. Some of the symbols represent standards and compliances associated with the Digital Blood Pressure Monitor C04 and its use.

	CE Mark: conforms to essential requirements of the Medical Device Directive 93/42/EEC.
SN	Specifies serial number
	Type BF applied part
	Direct current
	DISPOSAL: Do not dispose this product as unsorted municipal waste. Collection of such waste separately for special treatment is necessary.
	Follow instructions for use
IP21	The degree of avoid ingress of water or particulate matter into ME equipment

	Put up
	Fragile
	Keep dry
	Avoid the sun
	Handle gently
	Temperature range
No Sterilize requirement	
Not category AP / APG equipment	
Mode of operation: continuous	

5.7. Memory

At the end of a measurement, this monitor automatically stores each result with date and time. Each unit stores 120 sets measurements for 2 users, totally 240 sets (User A and B) .

Viewing the stored values

With the unit off, press the Memory button. The display first shows "A", then shows an average of all measurements stored in the unit. Please note: Measurements for each user are averaged and stored separately. Be certain that you are viewing the measurements for the correct user. Pressing the Memory button again displays the previous value. To view a particular stored memory, press and hold the Memory button to scroll to that stored reading. Press the MEM button, the device will show the average value of latest 3 measurements. Press the MEM button again, the device will show Month and date, and in 1.5s later it will show the time. After showing the time, it will show the stored measurement value automatically. If you press the MEM button again, it will show the next stored measurement value.

5.8. Discontinuing a Measurement

If it is necessary to interrupt a blood pressure measurement for any reason (e.g the patient feels unwell), the Start/Stop button can be pressed at any time. The device then immediately lowers the cuff pressure automatically.

5.9. Battery Change Indicator

Batteries discharged– replacements required

When the batteries are discharged, the battery symbol will flash as soon as the instrument is switched on. You cannot take any further measurements and must replace the batteries.

The battery compartment is located on the back side of the unit.

- Remove cover from the bottom plate, as illustrated below picture-08
- Insert the batteries (3 x size AA). Always use AA long life batteries or alkaline 1.5v batteries.
- The memory retains all values although date and time must be reset - the year number therefore flashes automatically after the batteries are replaced.
- To set date and time, follow the procedure described in Section 4.2.

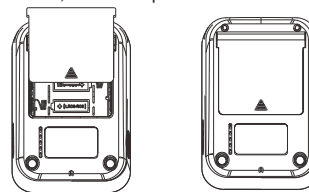

Picture-08

Which batteries and which procedure?

Use four new, longlife 1.5V AA batteries. Do not use batteries beyond their expiration date. If the monitor is not going to be used for a prolonged period the batteries should be removed.

Using rechargeable batteries

You can also operate this instrument using rechargeable batteries.

- Only use "NiMH" reusable batteries!
- If the battery symbol  the batteries must be removed and recharged! They must not remain inside the instrument, as they may become damaged through total discharge even when switched off. The batteries must NOT be discharged in the blood pressure monitor! If you do not intend to use the instrument for a week or more, always remove the rechargeable batteries!
- Recharge these batteries using an external charger and follow manufacturer's instructions carefully.

5.10. Using the AC Adapter

You may also operate this monitor using the AC adapter (output 5V DC 1A with Micro USB plug).

Use only the approved AC adapter to avoid damaging the unit.

- Ensure that the AC adapter and cable are not damaged.
- Plug the adapter cable into the AC adapter port on the right side of the blood pressure monitor.
- Plug the adapter into your electrical outlet. When the AC adapter is connected, no battery current is consumed.

Note: No power is taken from the batteries while the AC adapter is connected to the monitor. If electrical power is interrupted, (e.g., by accidental removal of the AC adapter from the outlet) the monitor must be reset by removing the plug from the socket and reinserting the AC adapter connection.

6. Care and Maintenance

Wash hands after each time measurement.

If one device is used by different patients, wash hands before and after each use.

- a) Do not expose the device to either extreme temperatures, humidity, dust or direct sunlight.
- b) The cuff contains a sensitive air-tight bubble. Handle this cuff carefully and avoid all types of stress through twisting or buckling.
- c) Clean the device with a soft, dry cloth. Do not use gas, thinners or similar solvents. Spots on the cuff can be removed carefully with a damp cloth and soapsuds. The cuff with bladder must not be washed in a dishwasher, clothes washer, or submerged in water.
- d) Handle the tube carefully. Do not pull on it. Do not allow the tubing to kink and keep it away from sharp edges.
- e) Do not drop the monitor or treat it roughly in any way. Avoid strong vibrations.
- f) Never open the monitor! This invalidates the manufacturer's warranty.
- g) Batteries and electronic instruments must be disposed of in accordance with the locally applicable regulations, not with domestic waste.

7. Warranty

Your blood pressure monitor is guaranteed for 1 year against manufacturers' defects for the original purchaser only, from date of purchase. The warranty does not apply to damage caused by improper handling, accidents, professional use, not following the operating instructions or alterations made to the instrument by third parties.

Warranty only applies to the instrument. All accessories including the cuff are guaranteed for one year, USB charging cable is not included.

There are no user serviceable parts inside. Batteries or damage from old batteries is not covered by the warranty.

Note: According to international standards, your monitor should be checked for accuracy every year.

8. Certifications

Electromagnetic compatibility:

Device fulfills the stipulations of the International standard IEC60601-1-2

9. Technical Specifications

Model: C04

Weight: 189g (Batteries and AC adapter are not included)

Display: 62.5*63.5mm 【2.46"x2.5"】 LED Digital Display

Size: 126 (W) x 85 (L) x 57 (H) mm 【4.96"(W)x3.35"(L)x2.24"(H)】

Accessories: 1×Main Device, 1×Cuff, 1×Users manual, 1×Warranty card

Operating Conditions: Temperature: 5 °C to 40 °C; Humidity : 15% to 93% RH;
Storage And Shipping Conditions: Temperature: -25 °C to +70 °C ; Humidity: ≤ 93% RH;

Atmospheric pressure range : 70kPa~106kPa

Measuring method: Oscillometric
 Pressure sensor: Resistive
 Measuring range: DIA: 40-130mmHg; SYS: 60-230mmHg
 Pulse: 40 to 170 per minute
 Cuff pressure display range:<300mmHg
 Memory: Automatically stores the last 120 measurements for 2 users (total 240)
 Measuring resolution: 1 mmHg
 Accuracy: Pressure within ± 3 mmHg / pulse ± 5 % of the reading
 Power source: a) 3*AA batteries, 1.5 V
 b) AC adapter INPUT: 100-240VAC 50/60HZ OUTPUT: 5V DC 1A
 Accessories: Wide range rigid cuff 8.7" – 15.7" (22 - 42 cm)
 Automatically power off : 60 seconds
 Users: Adult
 Expected service life of the device and accessories: 5 years
 Technical alterations reserved!

10. EMC Declaration

- 1) *This product needs special precautions regarding EMC and needs to be installed and put into service according to the EMC information provided, and this unit can be affected by portable and mobile RF communications equipment.
- 2) * Do not use a mobile phone or other devices that emit electromagnetic fields, near the unit. This may result in incorrect operation of the unit.
- 3) * Caution: This unit has been thoroughly tested and inspected to assure proper performance and operation!
- 4) * Caution: this machine should not be used adjacent to or stacked with other equipment and that if adjacent or stacked use is necessary, this machine should be observed to verify normal operation in the configuration in which it will be used

Guidance and manufacturer's declaration – electromagnetic immunity			
The device is intended for use in the electromagnetic environment specified below. The customer or the user of device should assure that it is used in such an environment.			
Immunity test	IEC 60601 test level	Compliance level	Electromagnetic environment - guidance
Electrostatic discharge (ESD) IEC 61000-4-2	± 8 kV contact ± 2 kV, ± 4 kV, ± 8 kV, ± 15 kV air	± 8 kV contact ± 2 kV, ± 4 kV, ± 8 kV, ± 15 kV air	Floors should be wood, concrete or ceramic tile. If floor are covered with synthetic material, the relative humidity should be at least 30%.
Electrical fast transient/burst IEC 61000-4-4	± 2 kV for power supply lines ± 1 kV for input/output lines	Not applicable	Mains power quality should be that of a typical commercial or hospital environment.
Surge IEC 61000-4-5	± 1 kV line(s) to line(s) ± 2 kV line(s) to earth	Not applicable	Mains power quality should be that of a typical commercial or hospital environment.
Voltage dips, short interruptions and voltage variations on power supply input lines IEC 61000-4-11	0 % Ur; 0.5 cycle at 0°, 45°, 90°, 135°, 180°, 225°, 270°, 315° 0 % Ur; 1 cycle 70 % Ur; 25/30 cycle 0% Ur; 250/300 cycle	Not applicable	Mains power quality should be that of a typical commercial or hospital environment. If the user of the device requires continued operation during power mains interruptions, it is recommended that the device be powered from an uninterruptible power supply or a battery.
Power frequency (50Hz/60Hz) magnetic field IEC 61000-4-8	30 A/m 50/60Hz	30 A/m 50/60Hz	Power frequency magnetic fields should be at levels characteristic of a typical location in a typical commercial or hospital environment.
NOTE Ur is the a.c. mains voltage prior to application of the test level.			

Guidance and manufacture's declaration – electromagnetic immunity			
The device is intended for use in the electromagnetic environment specified below. The customer or the user of the device should assure that it is used in such an environment.			
Immunity test	IEC 60601 test level	Compliance level	Electromagnetic environment - guidance
Conducted RF IEC 61000-4-6	3 Vrms 150 kHz to 80 MHz 3 V RMS outside the ISM band, 6 V RMS in the ISM and amateur bands 80% AM at 1kHz	Not applicable	Portable and mobile RF communications equipment should be used no closer to any part of the device, including cables, than the recommended separation distance calculated from the equation applicable to the frequency of the transmitter. Recommended separation distance d=0.35√p d=1.2√p
Radiated RF IEC 61000-4-3	10 V/m 80 MHz to 2.7 GHz 80% AM at 1kHz	10 V/m 80 MHz to 2.7 GHz 80% AM at 1kHz	80MHz to 800MHz: d=1.2√p 800MHzto 2.7GHz: d=2.3√p Where, P is the maximum output power rating of the transmitter in watts (W) according to the transmitter manufacturer and d is the recommended separation distance.  Field strengths from fixed RF transmitters, as determined by an electromagnetic site survey, should be less than the compliance level in each frequency range. Interference may occur in the vicinity of equipment marked with the following symbol:
NOTE 1 At 80 MHz and 800 MHz, the higher frequency range applies. NOTE 2 These guidelines may not apply in all situations. Electromagnetic propagation is affected by absorption and reflection from structures, objects and people.			
A Field strengths from fixed transmitters, such as base stations for radio (cellular/cordless) telephones and land mobile radios, amateur radio, AM and FM radio broadcast and TV broadcast cannot be predicted theoretically with accuracy. To assess the electromagnetic environment due to fixed RF transmitters, an electromagnetic site survey should be considered. If the measured field strength in the location in which the device is used exceeds the applicable RF compliance level above, the device should be observed to verify normal operation. If abnormal performance is observed, additional measures may be necessary, such as re-orienting or relocating the device.			
B Over the frequency range 150 kHz to 80 MHz, field strengths should be less than 3 V/m.			

Guidance and manufacture's declaration – electromagnetic emission		
The device is intended for use in the electromagnetic environment specified below. The customer of the user of the device should assure that it is used in such an environment.		
Emission test	Compliance	Electromagnetic environment – guidance
RF emissions CISPR 11	Group 1	The device use RF energy only for its internal function. Therefore, its RF emissions are very low and are not likely to cause any interference in nearby electronic equipment.
RF emission CISPR 11	Class B	The device is suitable for use in all establishments, including domestic establishments other than domestic and those directly connected to the public low-voltage power supply network that supplies buildings used for domestic purposes.
Harmonic emissions IEC 61000-3-2	Not applicable	
Voltage fluctuations/ flicker emissions IEC 61000-3-3	Not applicable	

Recommended separation distances between portable and mobile RF communications equipment and the device			
The device is intended for use in an electromagnetic environment in which radiated RF disturbances are controlled. The customer or the user of the device can help prevent electromagnetic interference by maintaining a minimum distance between portable and mobile RF communications equipment (transmitters) and the device as recommended below, according to the maximum output power of the communications equipment.			
Rated maximum output power of transmitter (W)	Separation distance according to frequency of transmitter (m)		
	150 kHz to 80 MHz	80 MHz to 800 MHz	800 MHz to 2.7 GHz
	$d = 1,2\sqrt{P}$	$d = 1,2\sqrt{P}$	$d = 2,3\sqrt{P}$
0,01	0,12	0,12	0,23
0,1	0,38	0,38	0,73
1	1,2	1,2	2,3
10	3,8	3,8	7,3
100	12	12	23
For transmitters rated at a maximum output power not listed above, the recommended separation distance d in metres (m) can be estimated using the equation applicable to the frequency of the transmitter, where P is the maximum output power rating of the transmitter in watts (W) according to the transmitter manufacturer.			
NOTE 1 At 80 MHz and 800 MHz, the separation distance for the higher frequency range applies. NOTE 2 These guidelines may not apply in all situations. Electromagnetic propagation is affected by absorption and reflection from structures, objects and people.			

Guidance and manufacturer's declaration - electromagnetic immunity

The device is intended for use in the electromagnetic environment specified below. The customer or the user of the device, should assure that it is used in such an environment.

Test frequency (MHz)	Band ^{a)} (MHz)	Service ^{a)}	Modulation ^{a)}	Maximum power (w)	Distance (m)	IMMUNITY TEST LEVEL (V/m)
385	380-390	TETRA 400	Pulse Modulation ^{b)} 18 Hz	1.8	0.3	27
450	430-470	GMRS 460, FRS 460	FM ^{c)} ±5 kHz deviation 1 kHz sine	2	0.3	28
710	704-787	LTE Band 13, 17	Pulse Modulation ^{b)} 217 Hz	0.2	0.3	9
745						
780						
810	800-960	GSM 800/900, TETRA 800, iDEN 820, CDMA 850, LTE Band 5	Pulse Modulation ^{b)} 18 Hz	2	0.3	28
870						
930						
1720	1700-1990	GSM 1800; CDMA 1900; GSM 1900; DECT; LTE Band 1,3 4.25;UMTS	Pulse Modulation ^{b)} 217 Hz	2	0.3	28
1845						
1970						
2450	2400-2570	Bluetooth, WLAN 802.11 b/g/n, RFID 2450, LTE Band 7	Pulse Modulation ^{b)} 217 Hz	2	0.3	28
5240	5100-5800	WLAN 802.11 a/n	Pulse Modulation ^{b)} 217 Hz	0.2	0.3	9
5500						
5785						

NOTE If necessary to achieve the IMMUNITY TEST LEVEL, the distance between the transmitting antenna and the ME EQUIPMENT or ME SYSTEM may be reduced to 1 m. The 1 m test distance is permitted by IEC 61000-4-3.

- a) For some services, only the uplink frequencies are included.
- b) The carrier shall be modulated using a 50% duty cycle square wave signal.
- c) As an alternative to FM modulation, 50% pulse modulation at 18 Hz may be used because while it does not represent actual modulation, it would be worst case.

The MANUFACTURER should consider reducing the minimum separation distance, based on RISK MANAGEMENT, and using higher IMMUNITY TEST LEVELS that are appropriate for the reduced minimum separation distance. Minimum separation distances for higher IMMUNITY TEST LEVELS shall be calculated using the following equation:

$$E = \frac{E}{d} \sqrt{P}$$

Where P is the maximum power in W, d is the minimum separation distance in m, and E is the IMMUNITY TEST LEVEL in V/m.