



BellaBot

Premium Delivery Robot

About BellaBot

Product Overview

Product Features

Product Value

Client Case

About Pudu



BellaBot

Premium Delivery Robot

BellaBot, a premium delivery robot, is designed by Pudu for the pursuit of quality service. It inherits the outstanding characteristics of the previous generation while being endowed with superior human-Robot interaction capabilities. Featuring an innovative bionic design language, lovely modeling, multi-modal interaction, and many other new functions. BellaBot provides users with an unprecedented food delivery robot experience.





Product Overview · BellaBot

3D Obstacle Avoidance Sensor

The RGBD on BellaBot's neck and two sets of cameras on its chassis provide BellaBot with 3D perception.

ABS Industrial Plastic & Aviation Grade Al-Alloy

Structurally stable, oxidation-resistant, and corrosion-resistant.

Latest Lidar

Customized lidar with more accurate detection.

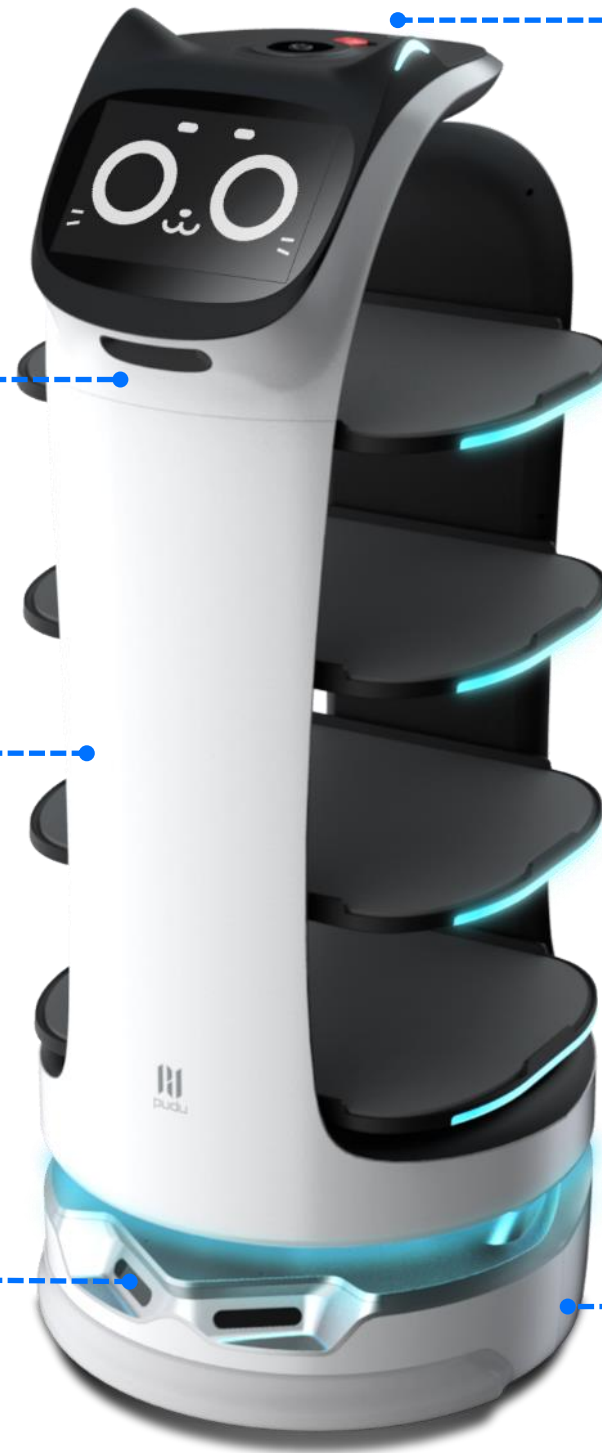

Visual Camera

The infrared camera on top of BellaBot provides real-time V-SLAM positioning and navigation.

Infrared Induction Tray

4* induction trays that intelligently perceive the tray's load, and ensure higher efficiency of distribution.

Dish cover (Accessory)

Enclosed dish cover with 3 layers of large space, magnetic door-opening method. Contactless delivery, safer service.

Independent Suspension

Auto-level independent linkage suspension system with high-efficiency on bump avoidance.

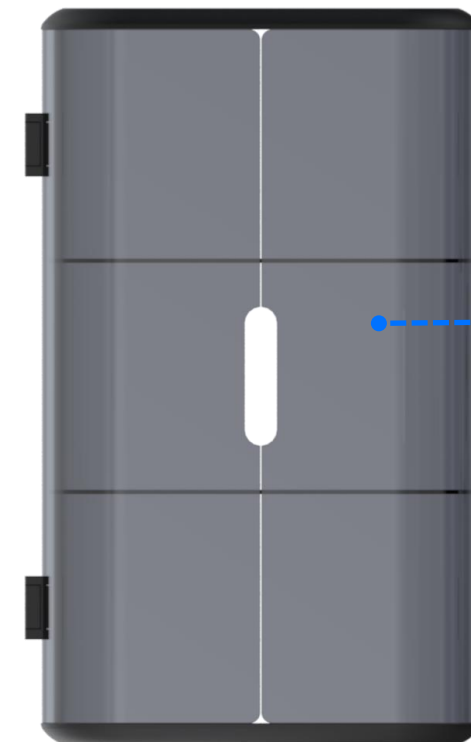



Product Overview · BellaBot

Category	Specifications	Description
Exterior and Performance	Machine dimension	<ul style="list-style-type: none">• 565*537*1290 mm
	Tray size	<ul style="list-style-type: none">• Tray size 410mm*500mm• Loading dimension: 385mm*480mm
	Num. of trays	<ul style="list-style-type: none">• 4-layer tray, with a height of 230/200/200/180mm from top to bottom
	Robot weight	<ul style="list-style-type: none">• 55kg
	Load capacity	<ul style="list-style-type: none">• Max 40kg, 10kg/layer
Power Adapter and Battery	Battery capacity	<ul style="list-style-type: none">• 25.2V/25.6Ah
	Quick-release battery	<ul style="list-style-type: none">• Power exchange technology allows for easy removal and replacement of the battery to ensure BellaBot's continuous operation
	Battery Life	<ul style="list-style-type: none">• 12-24H (Replaceable Battery)
	Charging time	<ul style="list-style-type: none">• 4.5H
Movement Functions	Location positioning	<ul style="list-style-type: none">• Support both Marker Positioning and Laser Positioning
	Perception	<ul style="list-style-type: none">• Minimum size of object for obstacle avoidance: 35mm*50mm*100mm• Minimum clearance: 0.7m
	Dispatching	<ul style="list-style-type: none">• A maximum of 20 robots of the same version can be dispatched at the same time
	Safety	<ul style="list-style-type: none">• Speed: 0.5-1.2m/s (Adjustable)• Climbing angle: $\leq 5^\circ$



Dish Cover Specifications

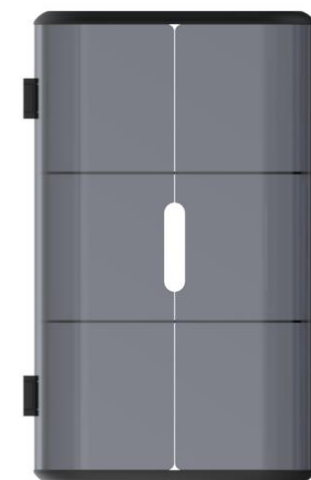
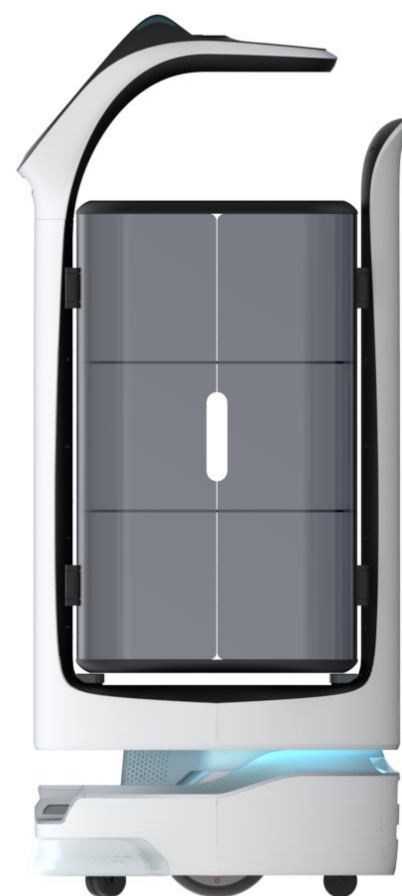

Cover material	Plexiglass / Ma-Al Alloy
Cover weight	16kg
Cover dimensions	514*420*677mm
Load capacity	3 trays, 10kg/tray
Door opening method	Magnetic Switch

* Accessory



CONTENT

About BellaBot

Product Overview

Product Features

Product Value

Client Case

About Pudu



Intelligent Multifunctional Delivery

NEW

Greeting Mode

BellaBot features a greeting mode in which it takes over reception and escorts guests to their table.

Delivery Mode

BellaBot delivers food to multiple tables at once.

Cruise Mode

BellaBot circulates along a predetermined path with self-service drinks and desserts and recommends them to customers by voice.

Birthday Mode

BellaBot delivers birthday cake or gifts to customers, accompanied by customized background music.

Dish-return Mode

BellaBot collects dishes to be cleaned and delivers them to the dish-return spot or the dish-washing room.

Direct Mode

The robot performs one-way delivery.



Why BellaBot is premium delivery robot?

Intelligent Induction Tray



- Perceive the tray's load to ensure more efficient delivery.
- Modular structure for quick disassembly and easier cleanup.

Multimodal Interaction



- Light interaction, touch feedback, and smart expression allow for unprecedented human-robot interaction.

Power Exchange Technology



- Industry's first power exchange technology
- Enable to quickly replaced to keep the robot running around the clock.

Intelligent Lattice Screen



- A lattice screen on BellaBot's back
- Allowing to customize the table numbers, instructions, blessings, and other texts to customer needs.



Product Features - Dual SLAM Technology

Laser SLAM and Visual SLAM Dual Solution for Full Coverage in Any Scenario

- BellaBot supports two SLAM navigation solutions simultaneously in order to adapt to more scenarios, both of which are accurate and easy to use.
- Both positioning solutions which BellaBot provides the same excellent user experience. While the positioning solutions differ, BellaBot's customer-centered service never changes.



Visual SLAM

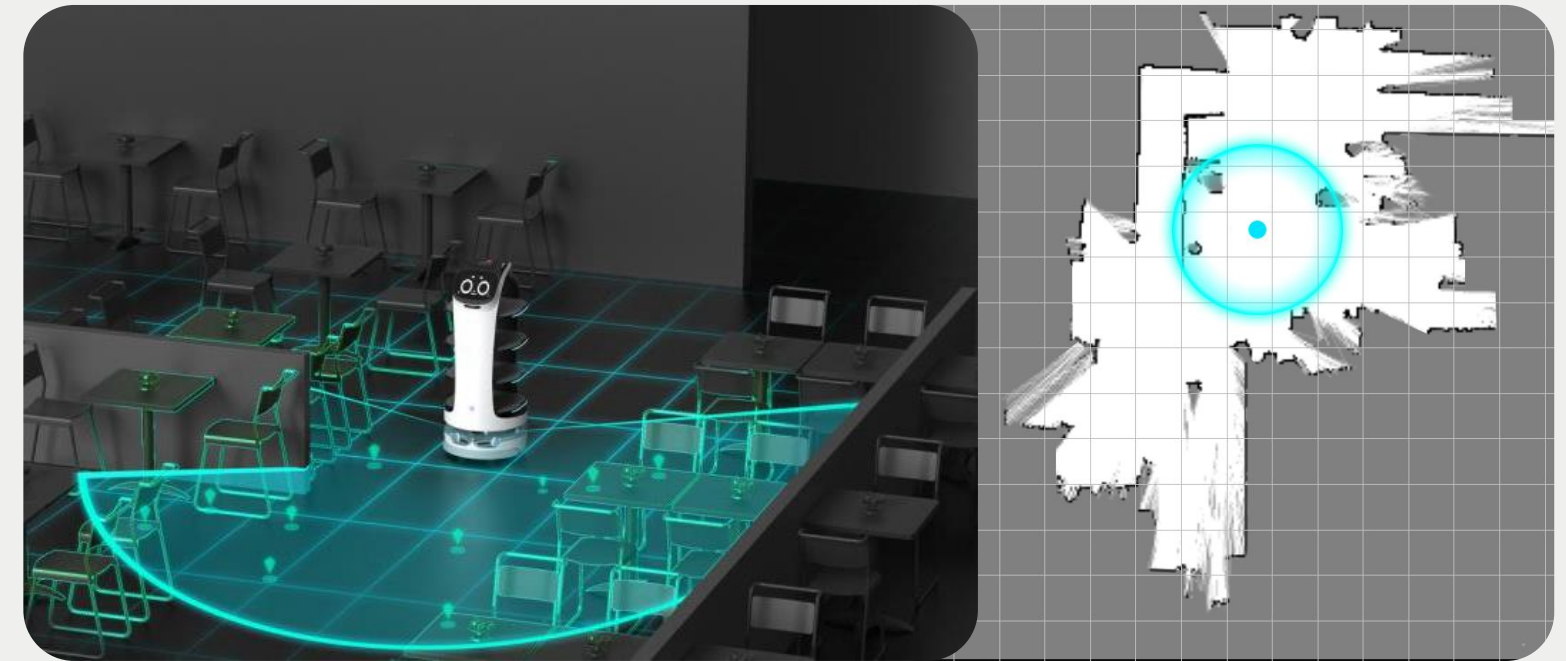

Laser SLAM



Attentive Service with Multimodal Interaction



Touch Interaction

Unique touch interaction design, allowing special guests interaction with BellaBot by touching her ears and forehead.

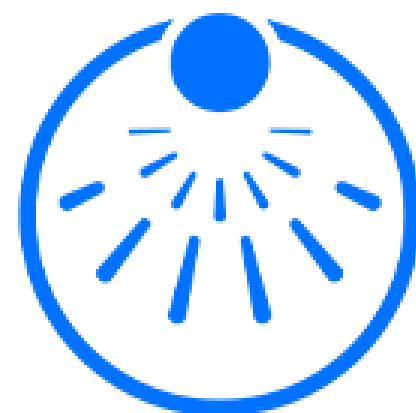

Light Interaction

Different tasks trigger corresponding light interactions; BellaBot's ears and tail can display its running status in real-time.



Expression Interaction

Dozens of original expressions are specially designed for BellaBot to add warmth to her expressions.



Product Features - High-sense & Obstacle Avoidance

3D obstacle avoidance technology to ensure safety



RGBD depth camera

3* RGBD depth camera provide BellaBot with the strongest three-dimensional perception to date. It can accurately detect and stop when encountering obstacles with a response time as short as **0.5s**.

- Front detection angle up to **192.64°**
- Front obstacle detection range exceeding **10m**.
- Mini height for object detection is **2cm**.
- Obstacle scanning frequency as rapid as **5400 times/min**.

70cm minimum clearance
navigate easily in the compact environments



Premier sensor featuring Pudu's SLAM algorithm, BellaBot has a minimum clearance of **70cm**.

Meets **99%** of scenarios involving required space in passageways

Flexible and Efficient



Product Features - Safe & Efficient

Auto-level independent linkage suspension for stable

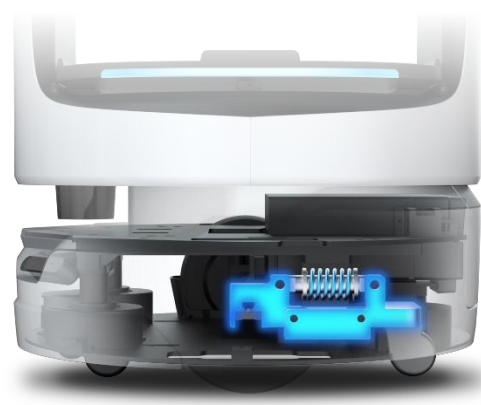

Auto-level adaptive variable suspension.

Damping can be altered based on various driving conditions.

Maintained at an optimal state

- Height over the obstacle: **1cm**.
- Driving stability has been improved by **50%**.

Power Exchange Technology



Charging and usage scenarios are categorized for faster battery replacement.

24/7 operations!



CONTENT

About BellaBot

Product Overview

Product Features

Product Value

Client Case

About Pudu



Enhancing Core Competitiveness with Differentiated Marketing

- The intelligent experiences enable customers and staffs to promote the restaurant online and offline voluntarily, which helps attract more potential customers and improve the restaurant's popularity as well as sales.
- The cute cat-like look immediately captures the eyes of customers, especially young people, and kids, attracting and leading them into the restaurant.

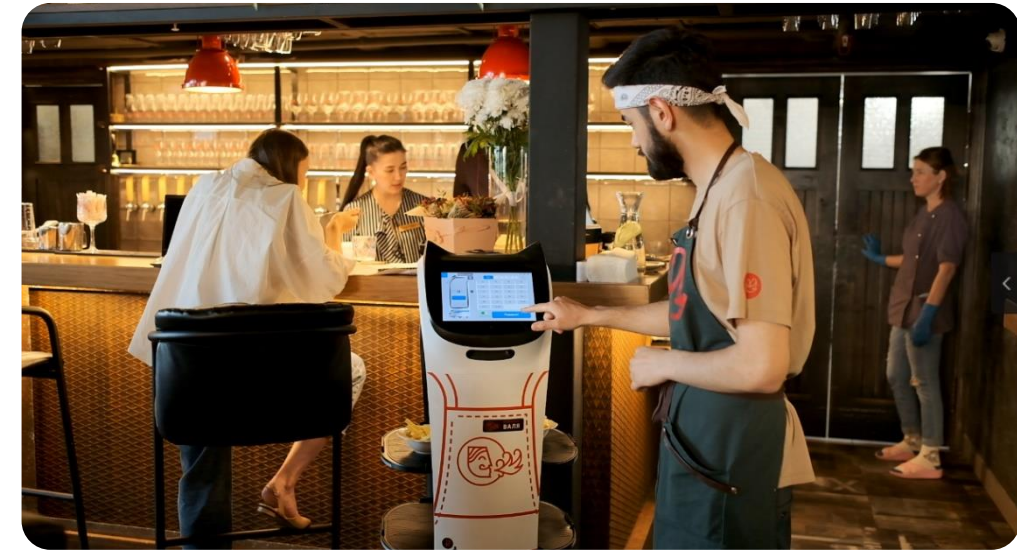

Optimizing Management for Reduced Labor Costs

- PUDU CLOUD platform drives the digital transformation of restaurants, providing real-time insights into the restaurant's operation by the daily delivery data.
- BellaBot is ready to serve you 7x24x365, reducing staff management costs, making staff management easier than ever.
- With a loading capacity of 2.5 times of a human being, BellaBot can deliver food to two tables in one go, effectively reducing the staff' s pressure in peak time.

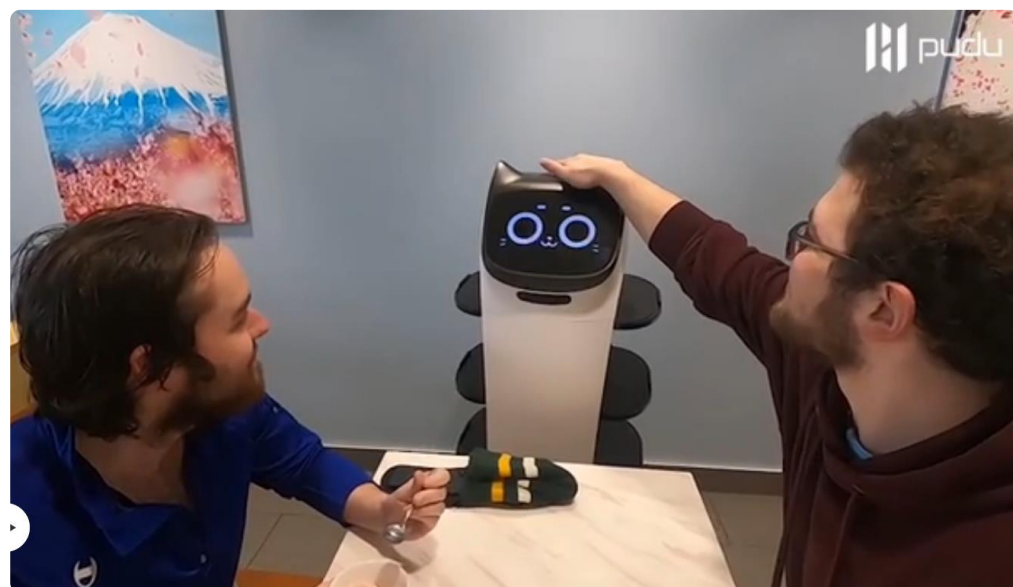

Empowering Safe, Efficient, and Intelligent Customer Experience

- BellaBot provides greeting and escorting, and multimodal interaction, giving customers an intelligent experience like never before.
- The extra-large loading capacity ensures a shorter waiting time for customers and a high table turnover rate for restaurants.



Allowing Waiters to Focus on Serving Customers Better

- BellaBot helps staff to do the tedious and repetitive work, allowing waiters to focus more on serving customers.
- More time and faster response, brought in a better customer experience, and ultimately higher customer satisfaction.



CONTENT

About BellaBot

Product Overview

Product Features

Product Value

Client Case

About Pudu



Client Case - All Scenarios Covered

All Scenarios Covered

Pudu has independently developed a robot positioning and navigation technology based on multi-sensor fusion. BellaBot provides two positioning and navigation solutions: visual SLAM and laser SLAM.

BellaBot can be used in restaurants, hotels, Bar, cafés, office buildings, and other business scenarios.



Restaurant



Bar



Cafés



Hospitals



Hotels



Government buildings



Office buildings



Shopping malls



Client Case - Key Clients





Client Case - Restaurant Cases

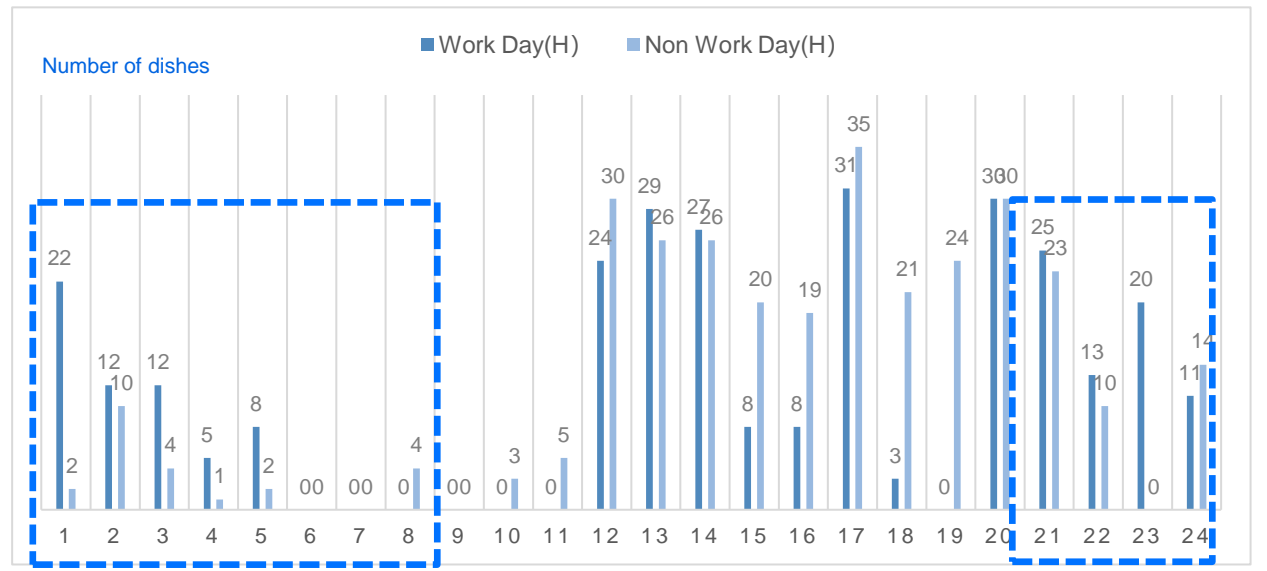

The robot can completely replace the waiting staff
from 9:00 pm to 7:00 am.

Robot usage data from a Haidilao restaurant in Shanghai

Number of tables: 60

Installation time: 1 day

Total floor area: 1000 m²

Dishes delivered: 240 times per day



A restaurant in Russia

Number of robots: 1 BellaBot

Restaurant area: 200 m²

Number of deliveries: 198 times per day



CONTENT

About BellaBot

Product Overview

Product Features

Product Value

Client Case

About Pudu



About Pudu · Company Profile



- National high-tech enterprise
- More than 600 patents, over 60% of which are patents for invention
- R&D staff accounts for over 50% of the total staff
- Products are sold to more than 60 countries and regions around the world
- Hundreds of after-sales service centers across the globe

Founded in 2016 and headquartered in Shenzhen, Pudu Robotics is a national high-tech enterprise dedicated to the design, R&D, production, and sales of commercial service robots. The company has set up R&D centers in Shenzhen and Chengdu, and hundreds of after-sales service centers across the globe.

Powered by the core technologies of positioning and navigation, motion control, multiple-robot dispatching, obstacle detection, and avoidance, NVH, intelligent interaction, and automated simulation testing, Pudu Robotics has developed more than 600 patents and top-notch delivery robots, disinfection robots as well as delivery & reception robot with an Ad display. As a world-leading provider of commercial service robots, Pudu Robotics has sold tens of thousands of robots to more than 60 countries and regions around the world. The robots are widely used in restaurants, hospitals, schools, office buildings, government halls, subway stations, waiting rooms, etc.



About Pudu - Core Technologies

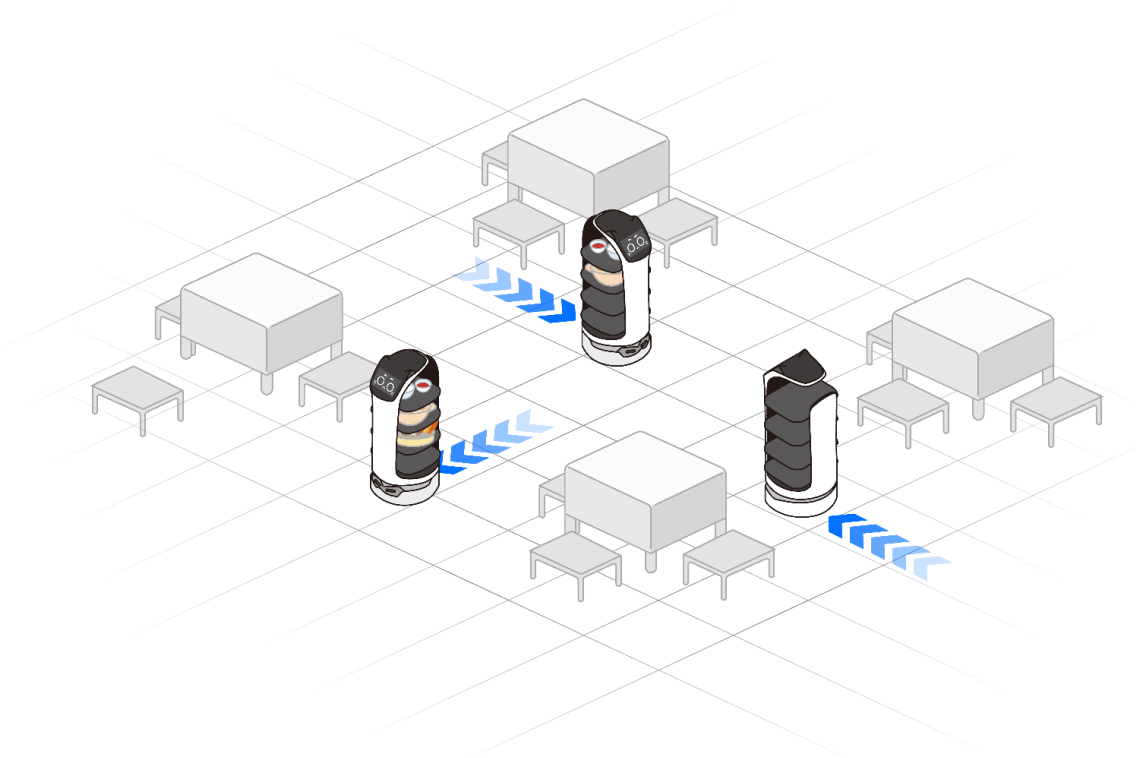

PUDU SCHEDULER

- Powerful ad hoc network
- Easy scheduling of up to 100 robots in the same working environment
- Flexibly adapted to dynamic environments
- From subway-level scheduling to road-level scheduling



PUDU MIR

PUDU MIR is the world's first robot development platform designed to improve the efficiency in robot development.

More features can be unlocked through remote OTA software update.



About Pudu - Core Technologies

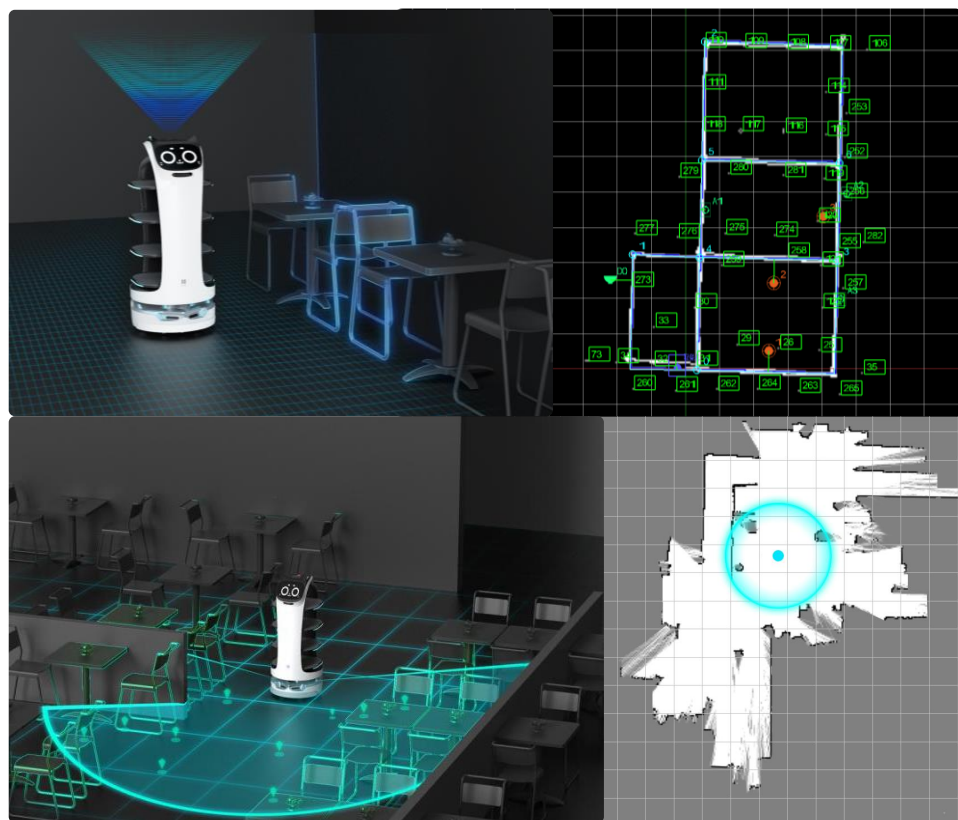

PUDU SLAM

PUDU SLAM is a new SLAM solution that integrates Lidar, Camera, RGBD, IMU, Encoder and other sensors.

The high positioning accuracy (10cm) allows the robot to effectively recognize and avoid 3D obstacles.

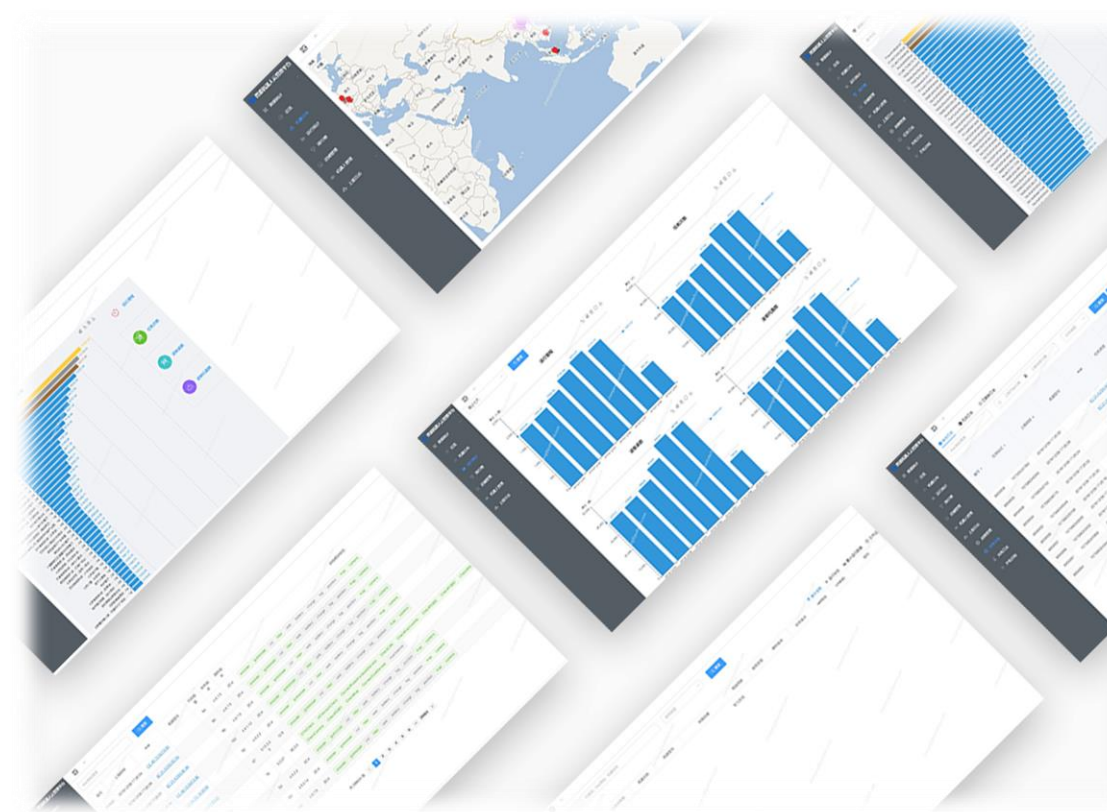

PUDU CLOUD

- Cloud-based intelligent service platform
- Scenario data collection platform
- Automated operation and maintenance platform
- Business management platform

The delivery data of each robot is uploaded in real-time, enabling data-driven management of the restaurant.



About Pudu · Safety Certifications

BellaBot robot has received KC certification from Korea, CE certification from the EU, FCC certification from USA, RCM certification from Australia, and NCC certification from Taiwan, China

IMDA certification from Singapore, MIC/TELEC certification from Japan, CR (China robot certification) and many other certifications both domestically and abroad to ensure the safety and compliance of our robots.



**INFOCOMM
MEDIA
DEVELOPMENT
AUTHORITY**





Create Your Exclusive BellaBot

Customized Appearance



Enhanced Promotion

- Go harmony with the vibe of the restaurant
- Greater brand and service exposure

3-day production

- Modular production (needs confirmation-design-launch) takes 3 days at the fastest

Customized Voice Pack



Cute girls



Cute boys



Sweet girls



Active boys

Multicolor Marker

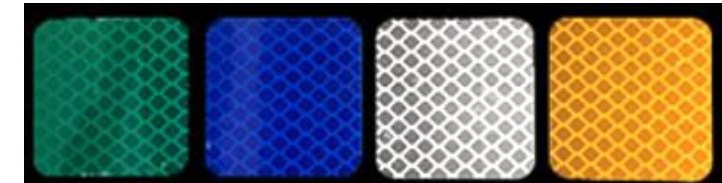

Notes: The colors are subject to the actual marker



Quality Services That You Can Rely On

Hundreds of after-sales service centers across the globe | 1-year free warranty | Free custom deployment | Free operation training | Fast service within 24 hours
IoT service: Over 90% of technical issues can be solved remotely

Contact Us:

Email: global_sales@pudutech.com

Connect with Us:





Panasonic



MINOR
HOTELS



DUNKIN'



 **Pudu Robotics**

SHENZHEN PUDU TECHNOLOGY CO., LTD.

Hotline: +86 18124141175 (GMT+8, 9:00 to 21:00 on weekdays)

Email: global_sales@pudutech.com

Address: 5/F, Building 1A, Shenzhen International Inno Valley Phase 1, Dashi 1st Road, Nanshan District,
Shenzhen, China 518300

Website: www.pudurobotics.com