

Tools

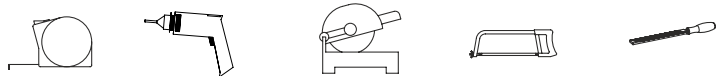

Included:
1 x NOR 625
Screws and plugs

All dimensions in mm

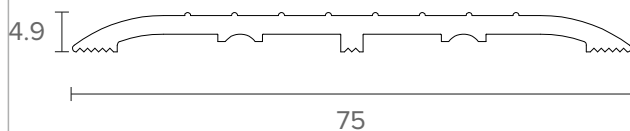

Length	Order Code
1000mm	NOR625-1000
2100mm	NOR625-2100

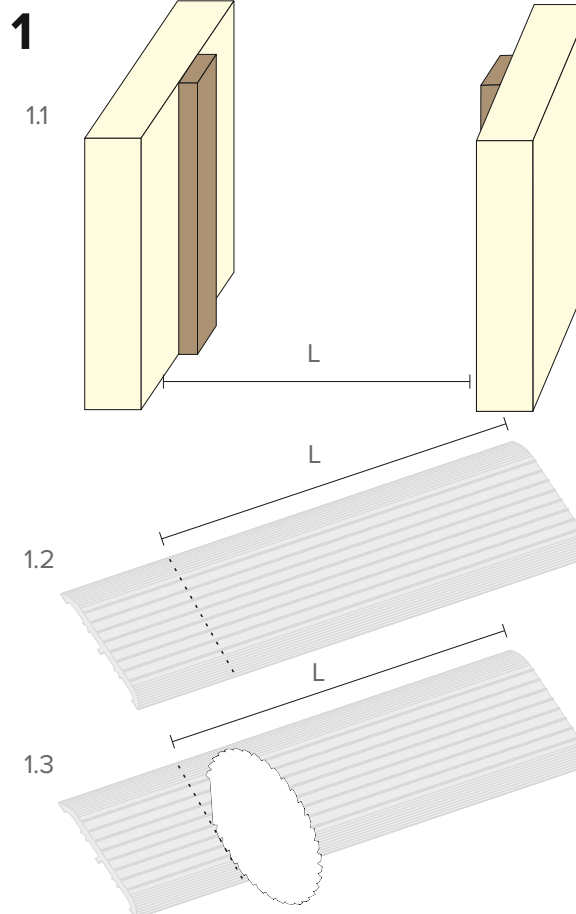

- 1.1** Measure the between door jambs (L)
- 1.2** Measure the threshold plate and accurately mark for cutting,
- 1.3** Machine cut the threshold plate to required length.

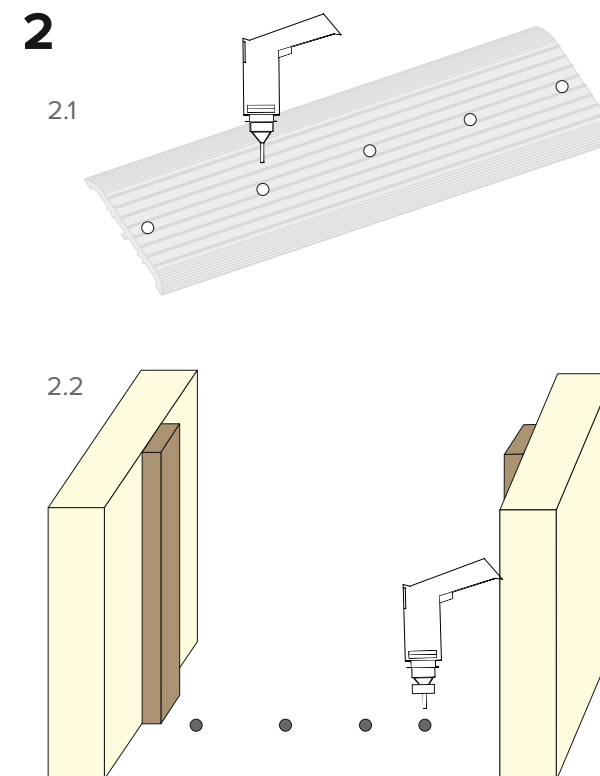

- 2.1** To screw fix. Firstly using a 4mm drill bit, drill holes 200mm apart along the threshold plate ensuring to countersink each hole.
- 2.2** If fixing to a concrete floor, place threshold in position and mark floor through holes in threshold plate, remove threshold and drill floor using 6mm masonry drill bit.

3

3.1

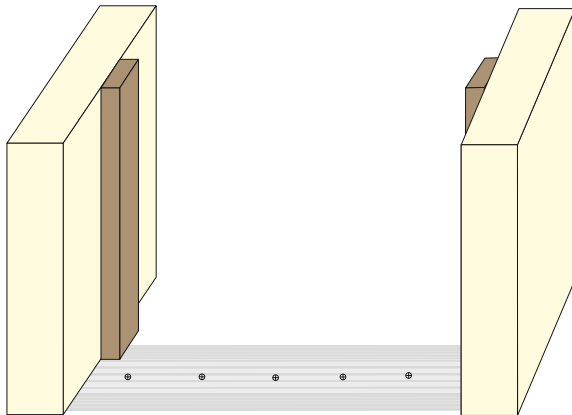
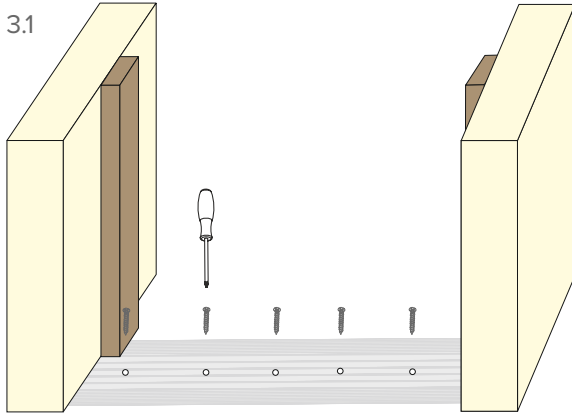

3.1 Place threshold in position and using the screws and plugs provided screw the threshold into place ensuring the screws are flush with the threshold.

4

4.1

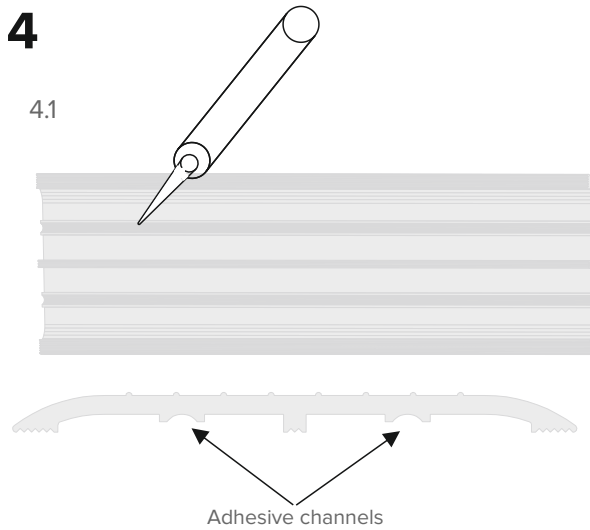

4.2

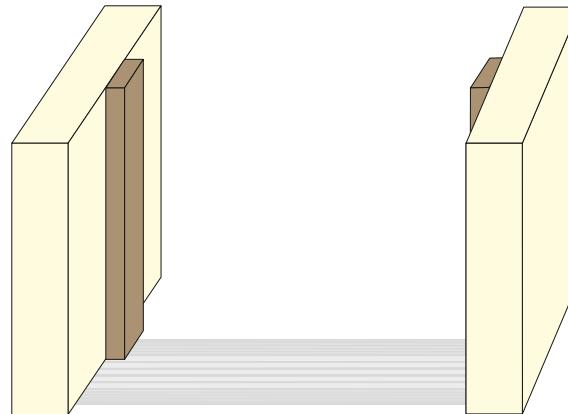

4.1 If adhesive fix is required run a bead of adhesive along the whole length of the threshold plate in both channels on the underside of the threshold.

4.2 Place in position and allow to dry.

5

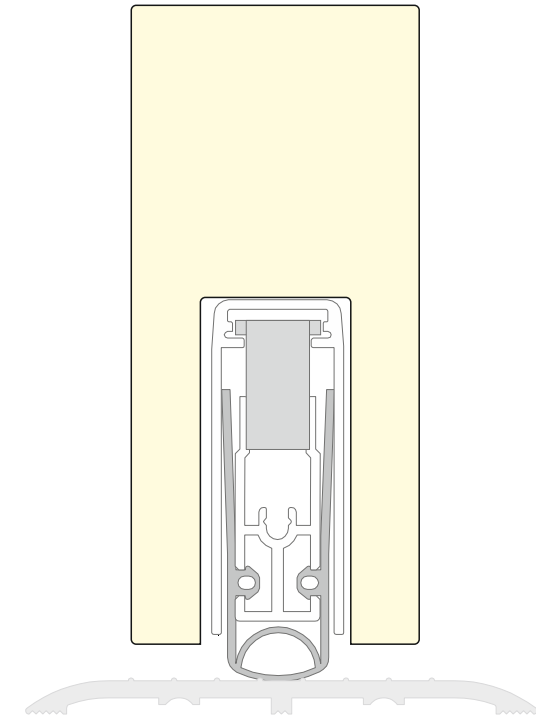

For copy fitting instructions visit norsound.com/fitting