



The eBike Display
User Manual

KD986

Product name and model

Name: Intelligent TFT display for E-bike

Model: KD986

Specifications

- 36V/48V Power Supply
- Rated working current: 10mA
- The maximum working current: 30mA
- Off-state leakage current: $<1\mu\text{A}$
- Operating temperature: $-20^{\circ}\text{C} \sim 60^{\circ}\text{C}$
- Storage temperature: $-30^{\circ}\text{C} \sim 70^{\circ}\text{C}$

Appearance and Size

- ◆ Display appearance and dimensional drawing (unit: mm)

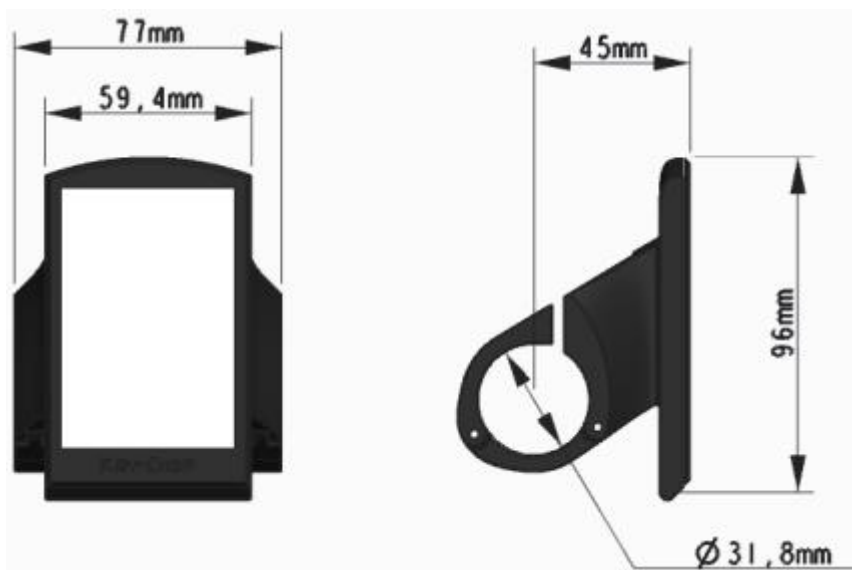

◆ Remote appearance and dimensional drawing (unit: mm)

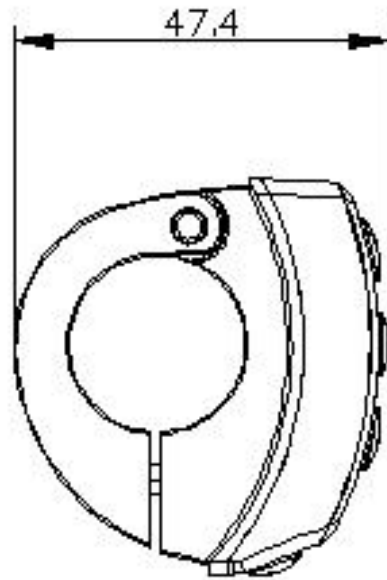
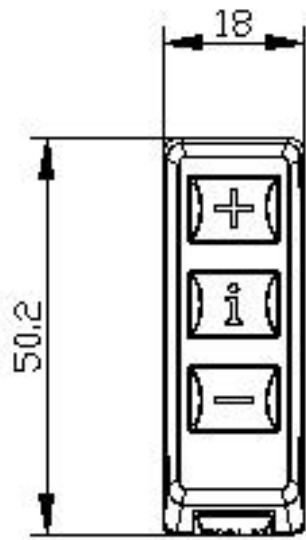

General Operation

◆ Switching the E-bike System On/Off

Press the power button to switch on the E-bike system.

To hold the power button for 2s, the E-bike system will be switched off. The E-bike system no longer uses the battery power.

When switching off the E-bike system, the leakage current is less than 1 μ A.

■ When parking the E-bike for more than 10 minutes, the E-bike system switches off automatically.

◆ Display Interface

After switching on the E-bike system, the display will show Speed and Trip Distance as default. Pressing the “i” button to switch between following elements:

Trip (Km) → ODO (Km) → Max. Speed (Km/h) → Avg. Speed (Km/h) → Time (Min.) .



Display Indication Cycle Interface

◆Switching Push-assistance Mode On/Off

To activate the push-assistance function, hold the “-” button. After 2s, The E-bike’s drive is activated at a uniform speed of 6 Km/h while the screen displays “”. The push-assistance function is switched off as soon as you release the “-” button on the operating unit .The E-bike system stops the power output immediately.



Push-assistance Mode

■ Push-assistance function may only be used when pushing the E-bike.

Be aware of danger of injury when the wheels of the E-bike do not have ground contact while using the push-assistance function.

◆Switching the Lighting On/Off

To switch on the headlight, hold the + button. The backlight brightness is automatically reduced. Hold the + button again, the lighting can be switched off.



Switching the Lighting Mode On/Off Interface

◆ Assist Level Selection

Briefly press "+" or "-" button to switch between assistance levels so as to change the motor output power, The default assistance level ranges from level "0" to level "5" , The output power is zero on Level "0" . Level "1" is the minimum power. Level "5" is the maximum power. When you reach "5" , press the "+" button again, the interface still shows "5" , and blinks at "5" to indicate the power highest. After the power downshift reaches "0" , press the "-" button again, the interface still shows "0" and blinks at "0" to indicate the power minimum. The default value is level "1" .



Assist Level Interface

◆ Battery SOC Indicator

The five battery bars represent the capacity of the battery. The five battery bars are bright when the battery is in high voltage. When percentage is 0%, the battery needs to be recharged immediately.

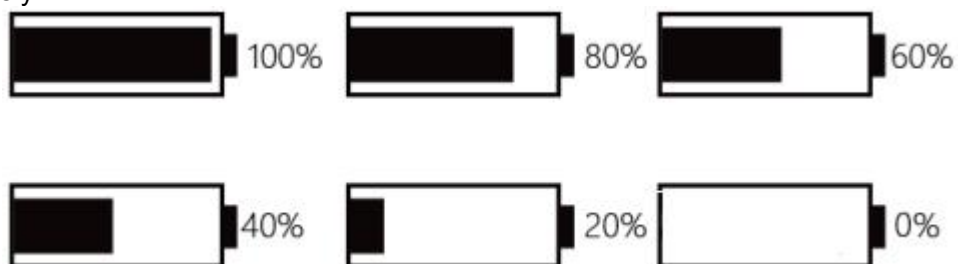

Battery SOC Indication Interface

◆ **Motor Power Indicator**

The power of the motor can be read via below interface



Motor Power Indication Interface

◆ **USB connection indication**

When the display is inserted into a USB external device, the display interface will show as below.

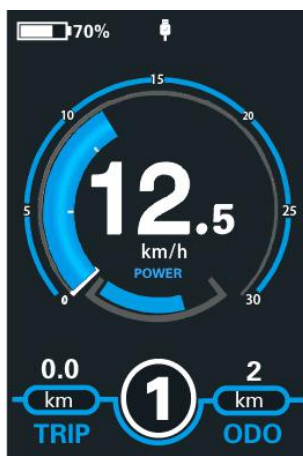

USB Connection Indication Interface

◆ **Error Code Indication**

The components of the E-bike system are continuously and automatically monitored. When an error is detected, the respective error code is indicated in text indication area.

Here is the detail message of the error code in **Attached list 1**.

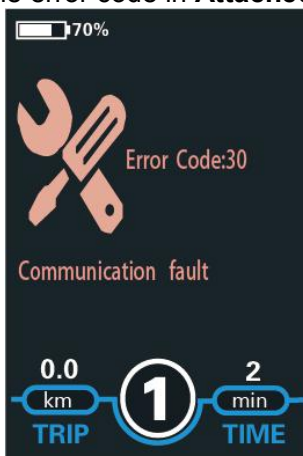

Error Code Indication

■ Have the display repaired when error code appears. Otherwise, you will not be able to ride the bike normally. Please always refer to an authorized dealer.

DisPlay Setting

Press the **On/Off** button to switch on the display.

To access Setting page, hold both the “+” button and the “-” button for 2s.

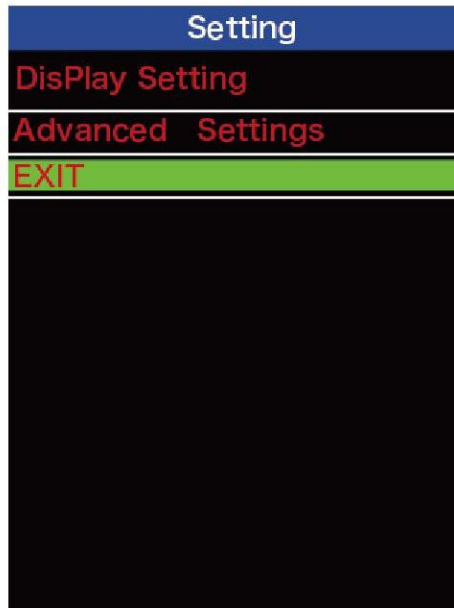

Setting interface

■ All the Settings are operated in the case of a parked E-bike.

◆ Trip Distance Clearance

Trip Reset represents trip distance clearance setting.

To clear trip distance, press the “+” button or the “-” button to select Yes or No. Yes represents clearing a single ride distance. No represents not clearing a single ride distance.

To store a changed setting, briefly press the “i” button to confirm.

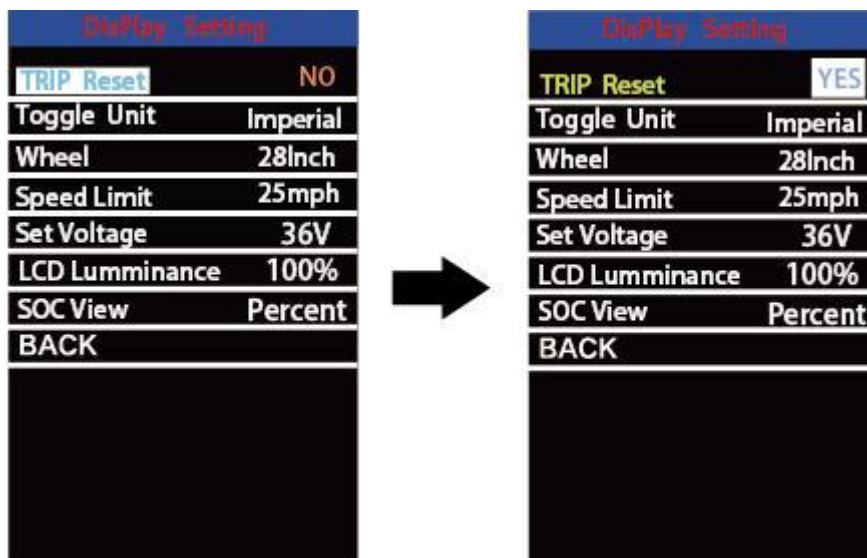

Trip Distance Clearance Settings Interface

◆Unit km/mile Conversion

Toggle Unit represents unit settings.

To toggle the unit, press the “+” button or the “-” button to choose the desired unit and press the “i” button to confirm. The default unit is “Metric (km)”.

To store a changed setting, briefly press the “i” button to confirm.

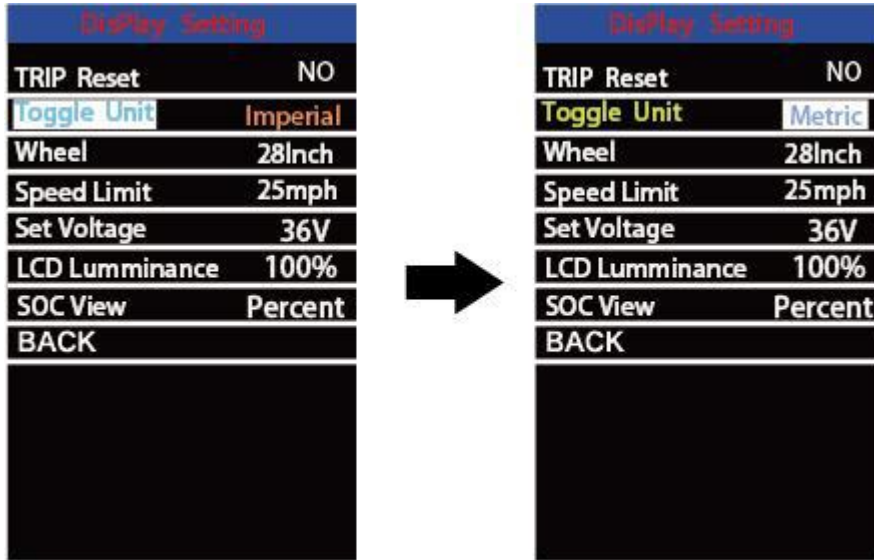

Mile and Kilometer Toggling Interface

◆Wheel Diameter Settings

Wheel represents wheel diameter settings. To change basic settings, press the “+” or the “-” button to increase or decrease until the desired value is displayed. The default value is 26 inch.

To store a changed setting, press the “i” button to confirm.

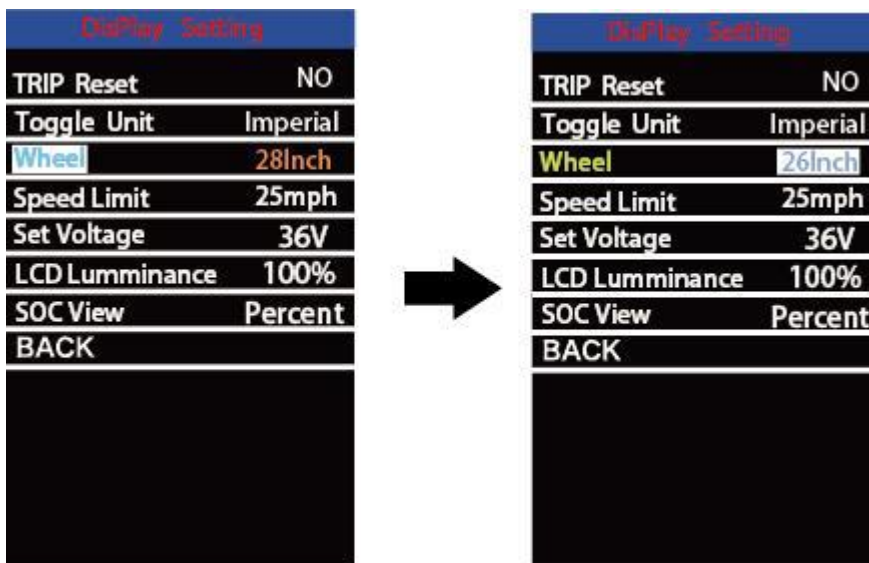

Wheel Diameter Settings Interface

◆ Speed-limit Settings

Speed Limit represents the limited speed settings. When the current speed is faster than speed limit, the E-bike system will be switched off automatically. Speed limit range is 12Km/h to 40Km/h. The default value is 25Km/h.

To change basic settings, press the “+” or the “-” button to increase or decrease until the desired value is displayed. Press the “i” button to confirm.

To store a changed setting, press the “i” button to confirm.

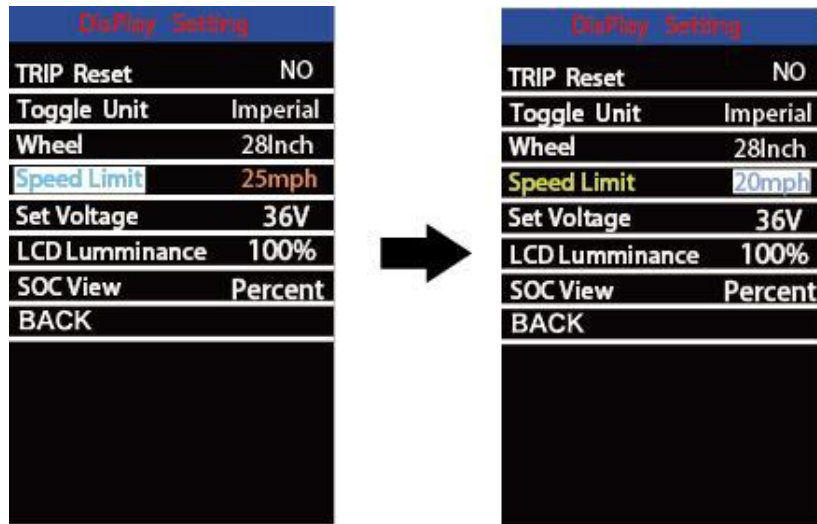

Speed limit settings interface

◆ Battery Power Bar Settings

Set Voltage represents voltage settings. 5 bar voltage values must be entered one by one. For example, “1-” is the first bar voltage value and its default value is 41.2V.

To set battery power bar, press the “+” or the “-” button to increase or decrease the voltage values.

To store a changed setting and access the next bar voltage setting, press the “i” button.

In the same manner, after 5 voltage values are entered completely, press the “i” button to confirm.

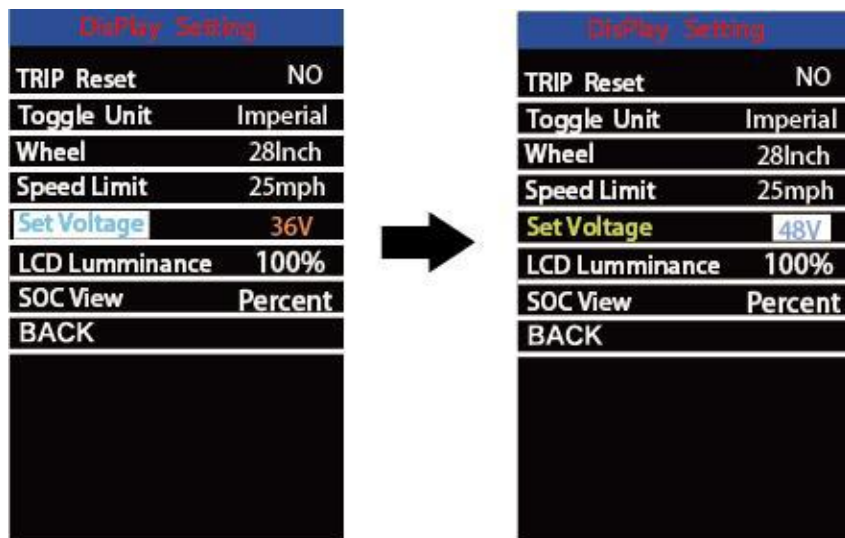

Battery Voltage Settings Interface

◆ Backlight Brightness Settings

LCD Luminance represents backlight brightness. 100% is the highest brightness. The less the percentage, the lower the backlight brightness.

To change the backlight brightness, press the “+” button or the “-” button to choose the desired percentage.

To store a changed setting, briefly press the “i” button to confirm.

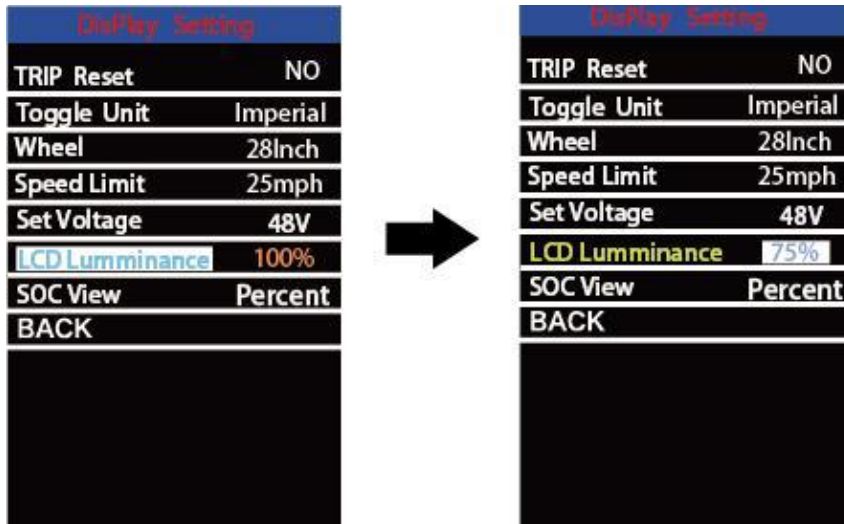

Backlight Brightness Settings Interface

◆ SOC View Settings

SOC view represents 2 display methods of remaining battery capacity. One is by the percentage and the other is by the Voltage value. Press the “+” button or the “-” button to choose the desired display method. The default view method is by the percentage.

To store a changed setting, briefly press the “i” button to confirm.

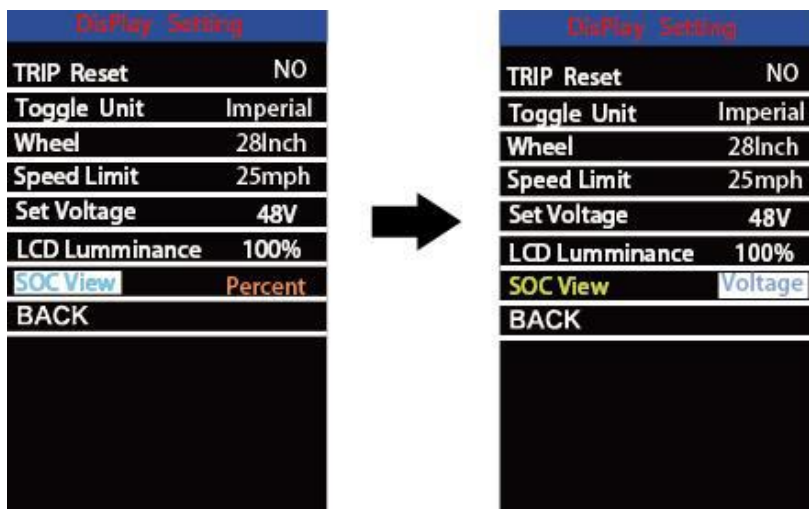

SOC view setting interface

Advanced Settings

After **DisPlay Setting** is done, Press Back to return to Setting page.

Press **UP/DOWN** button to choose Advanced Settings and press “i” button to enter Advanced Settings page.

◆ Assist Level Settings

Assist Level Mode Options

Power Set represents assist level settings. In assist level mode settings, there are 8 modes for your choice: 0-3, 1-3, 0-5, 1-5, 0-7, 1-7, 0-9, 1-9. The default mode is 0-5.

To change assist level mode, press the “+” or the “-” button to choose the desired mode and press the “i” button to confirm and access assist level ratio settings automatically.

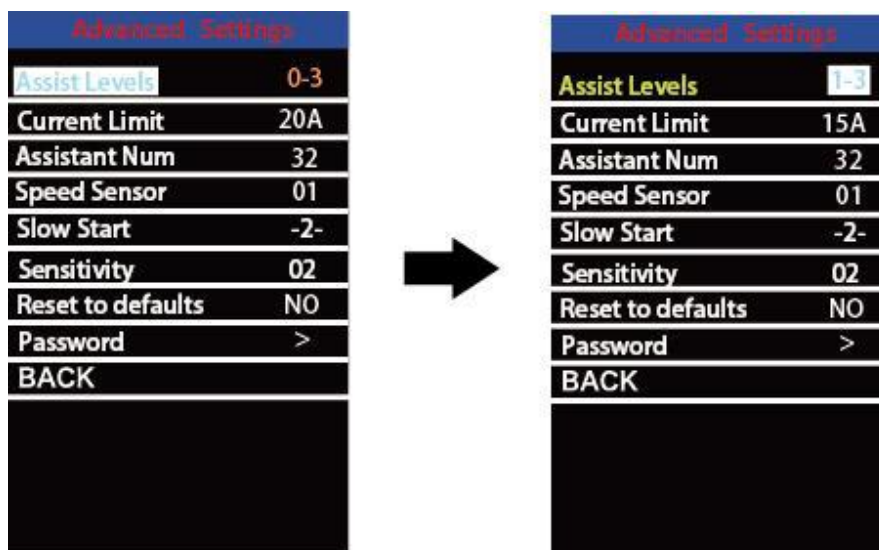

Assist Level Mode Settings Interface

Assist Level Ratio Settings

To change the ratio of a certain assist level, press the “+” button or “-” button to choose the desired ratio, and press the “i” button to confirm.

For example, the ratio range is “45-55 percent” for level “1”; percentage can be changed and the default ratio value is 50 percent.

To store a changed ratio setting, press the “i” button and move to the next level ratio setting.

After ratios of all assist levels are input, press the “i” button to confirm.

Please refer to assist level ratio default values in **Attached list 2**.

◆ Controller Over-current Cut Settings

Current Limit represents controller over-current cut settings. The current value can be changed from 7.0A to 25.0A. The default value is 15A.

To change basic settings, press the “+” or the “-” button to increase or decrease the value of the current.

To store a changed setting, press the “i” button to confirm.

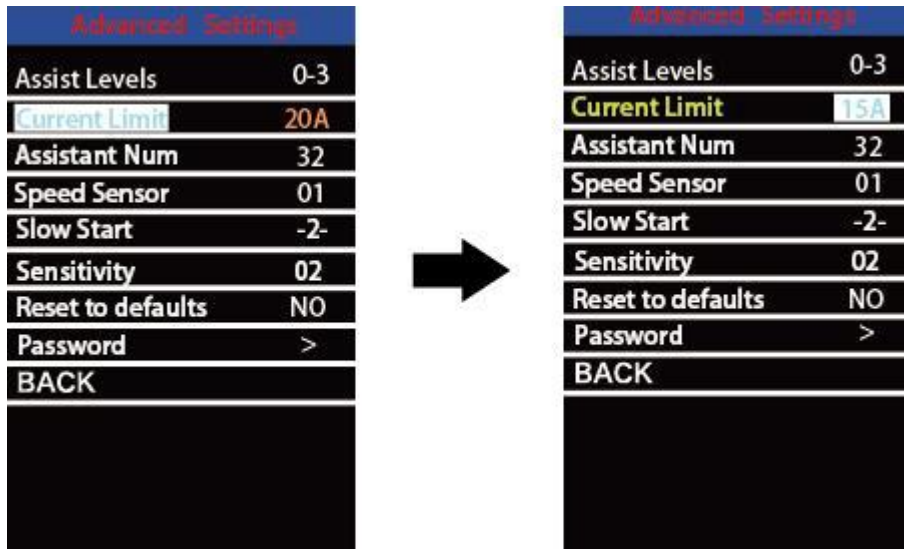

Current limit setting

◆ Power Assistant Sensor Magnets

Assistant Num represents the number of magnets in the PAS disk. The settable range is “5” to “24”. The default value is 12.

To change the magnet number of power assist sensor, press the “+” or the “-” button to choose the desired number.

To store a changed setting, press the “i” button to confirm

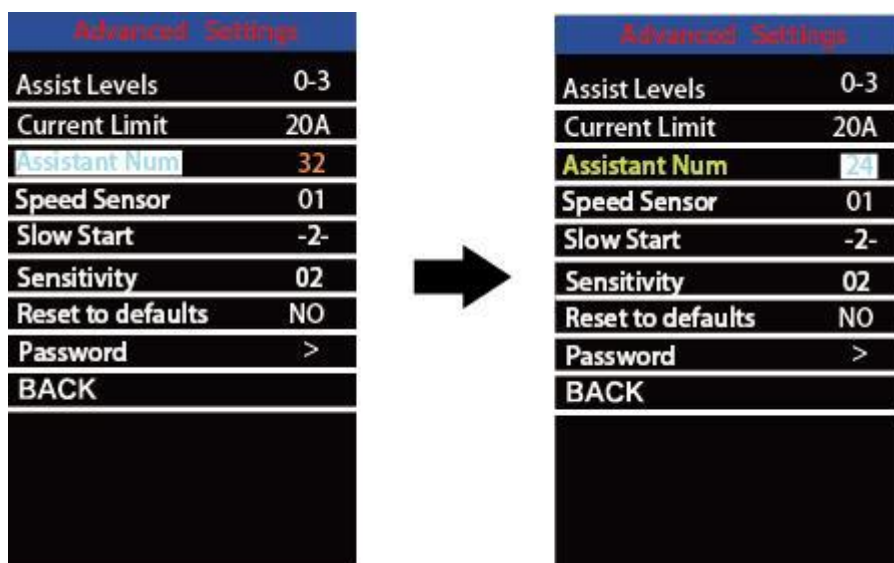

Assistant Num setting interface

◆Speed Sensor

Speed Sensor represents speed sensor settings.

To change speed sensor settings, press the “+” or the “-” button to select the quantity of magnet heads on the e-bike spoke (the range is from 1 to 15). The default value is 1.

To store a changed setting, press the “i” button to confirm.

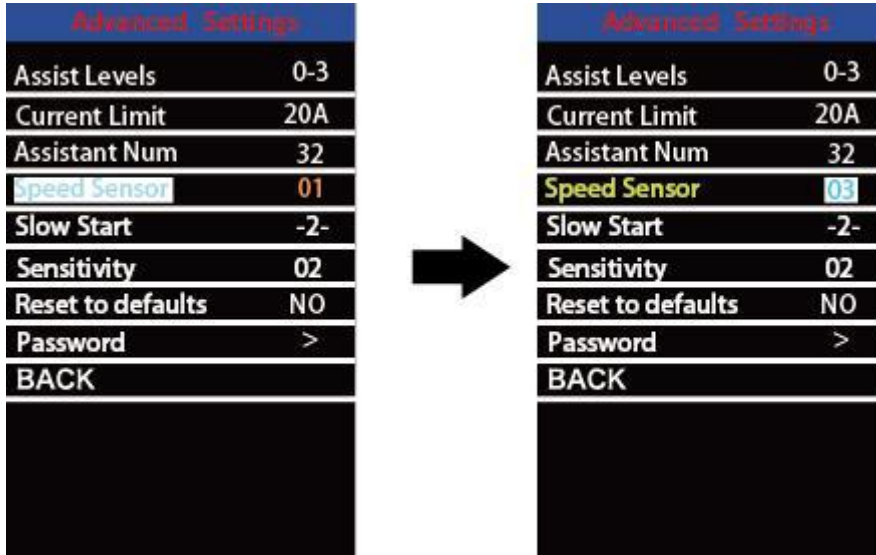

Speed sensor setting

◆Slow start

Slow start represents slow start-up settings. It is a time duration before you get power assistance when applying pedal power. The range is “1-4”. “4” is the slowest. The default value is “1”.

To change slow start up settings, press +/- button to choose the desired value. And press the i button to confirm.

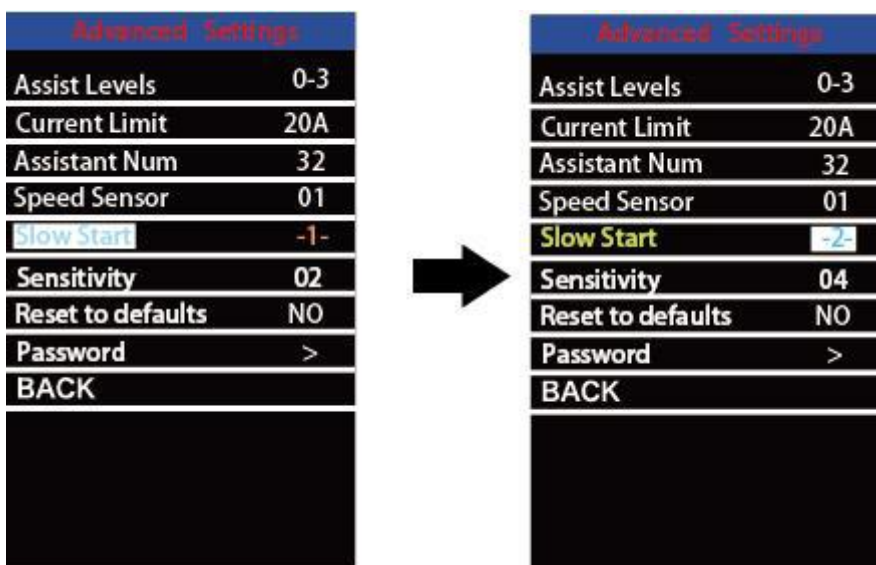

Slow start setting

◆Sensitivity

Sensitivity represents the sensitivity of power assist sensor. It means the motor assist should start after a certain number of magnets are passing on the power assist sensor. To change the value, press the “+” or the “-” button to choose the sensitivity value. The default value can be customized.

To store a changed setting, press the “i” button to confirm

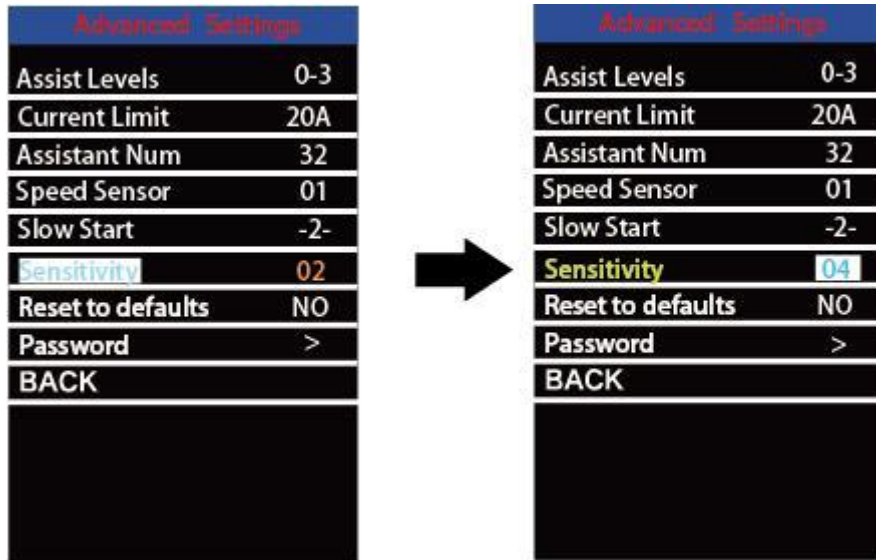

Sensitivity setting interface

◆Reset to defaults

Reset to defaults represents factory settings.

To reset to defaults, press the “+” or the “-” button to choose YES or NO. The default is NO.

To store a changed setting, press the “i” button to confirm.

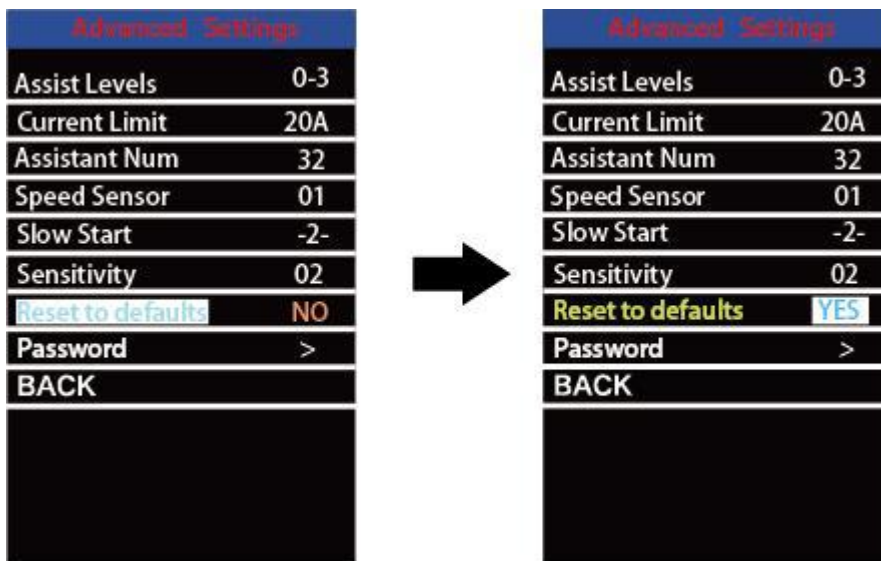

Reset to defaults

◆Power-on Password Settings

To access the power-on password setting page, select 'Password' in the menu and press "i" button to confirm.

PassWord Set means power-on password settings. Power-on password is a 4-digit code. The default password is '1212'.



Password Setting Interface

1.Power-on Password Disable/Enable

To enable or disable **Start PassWord** settings, press the "+" or the "-" button to select ON or OFF. ON means enabling a power-on password while OFF means disabling a power-on password. The default value is OFF.

To enable a power-on password, choose ON and press "i" button to confirm and input the current password or default password'1212'. Press the "+"or the "-"button to change the number and press the "i"button to confirm digits one by one until the correct password(*current password or default password'1212'*) is completed.

To disable the current password, choose OFF and press "i" button to confirm and input the current password correctly. The screen displays 'PassWord Canceled Successfully'. *Then the display password is restoring the default code '1212'.

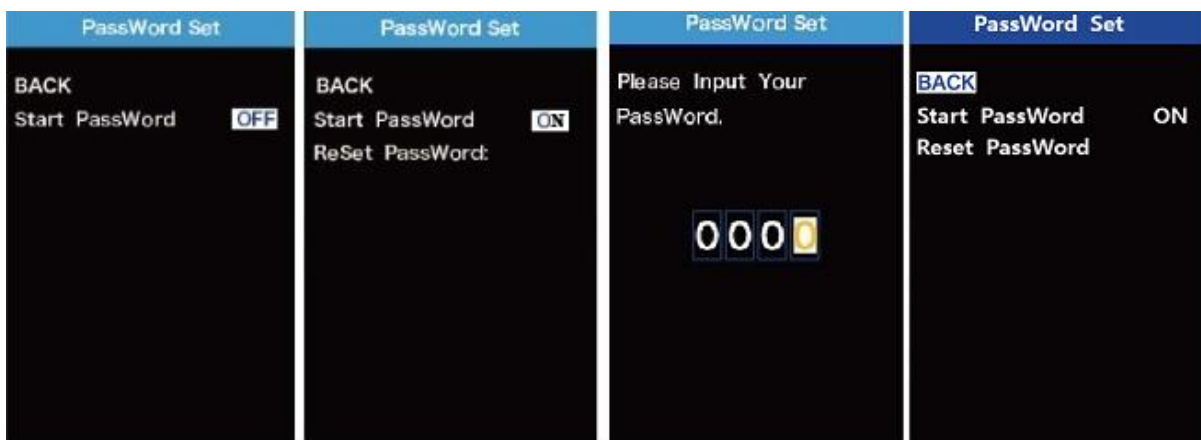

Password Enable/Disable Settings Interface

2. Power-on Password Reset

From the last interface above, press the “+” or the “-” button to select ‘**Reset PassWord**’ and press the “i” button to confirm to access power-on password reset interface. There are 3 pages for setting up a new password:

In the **first** page, please enter the current password or default password ‘1212’ correctly.

Then it moves to the **second** page for inputting a new password. Press the “+” or the “-” button to increase or decrease the number and then press the “i” button to confirm digits one by one until a new 4-digit password is completed.

Finally, it comes to the **third** page and reenter the new password again for confirmation. The screen displays ‘PassWord Reset Successfully’

When switching on the E-bike system next time, please enter the new password to power on.

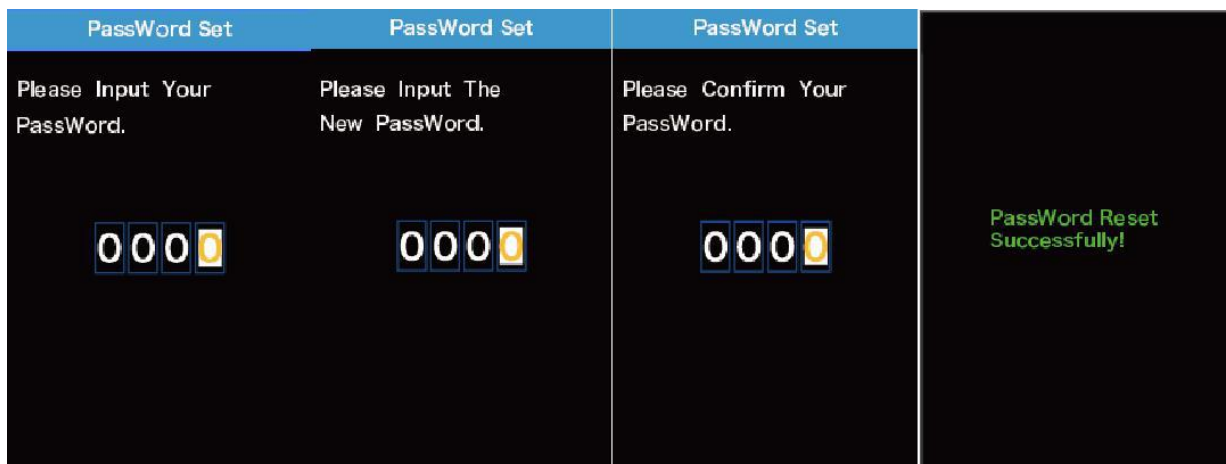

Password Change Interface

◆ Exit Settings

In the settings interface,

1. Briefly press the “i” button is to confirm and store a changed setting but stay within current setting menu.

2. Hold the “i” button for 1 second is to store a changed setting and exit current setting menu and return back to display start-up interface.

3. Hold the “-” button for 1 second is to cancel the setting operations without storing a change and return back to display start-up interface.

■ If there is no setting operations in one minute; the display will exit the settings state

Quality Assurance and Warranty Scope

I Warranty

- (1) The warranty will be valid only for products used in normal usage conditions.
- (2) The warranty is valid for 24 months after the shipment or delivery to customers

II The following cases do not belong to our warranty scope.

1. The display is demolished.
2. The damage of the display is caused by wrong installation or operation.
3. Shell of the display is broken when the display is out of the factory.
4. Wire of the display is broken.
5. The fault or damage of the display is caused by the force majeure (e.g., fire, earthquake, etc.).
6. Beyond Warranty period.

Connection Layout

Connector wire sequence

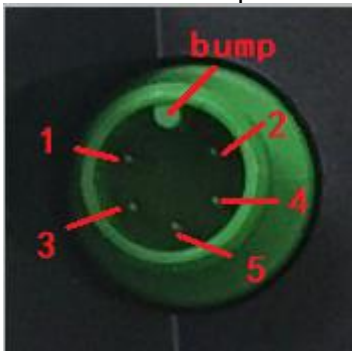

Display-side socket

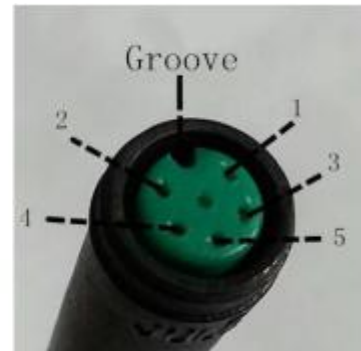

mating connector from controller side

wire sequence table

Wire no.	Color	Function
1	Red (VCC)	+
2	Blue (K)	Lock
3	Black (GND)	-
4	Green (RX)	RX
5	Yellow (TX)	TX

■Some displays have wire connection with water-proof connectors, users can not see the color of lead wires in the harness.

Warnings:

- ◆ Use the display with caution. Don't attempt to release or link the connector when battery is on.
- ◆ Try to avoid hitting the display.
- ◆ Don't modify system parameters to avoid parameter disorder.
- ◆ Make the display repaired when error code appears.

This manual instruction is a universal version for **DISPLAY KD986. Some versions of this display may be different from specification to specification as to the software. Please always refer to an actual version.*

Attached list 1: Error code definition

Error Code	Definition
21	Current Abnormality
22	Throttle Abnormality
23	Motor Phase Abnormality
24	Motor Hall Signal Abnormality
25	Brake Abnormality
30	Communication Abnormality

Attached list 2: Assist level ratio defaults

Level PAS Level mode	1	2	3	4	5	6	7	8	9
0-3/ 1-3	50%	74%	92%	—	—	—	—	—	—
0-5/ 1-5	50%	61%	73%	85%	96%	—	—	—	—
0-7/ 1-7	40%	50%	60%	70%	80%	90%	96%	—	—
0-9/ 1-9	25%	34%	43%	52%	61%	70%	79%	88%	96%