

OCTAVIA MIRROR INSTALL AND CARE

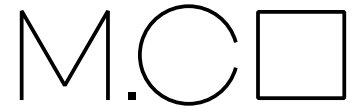

The dotted lines on your template indicate the centerlines of your mirror. Use them as guides for leveling the template. Next, tape the template to your wall.

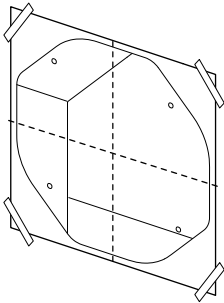

Drill 1/4" (6mm) diameter holes through the markings provided on the template. There is no need to find a stud in your wall. Be as precise as possible.

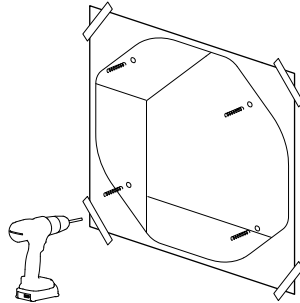

Remove template from the wall. Choose the appropriate anchor based on the material of your wall. Insert anchors into drilled holes. Anchor must be flush with the wall!

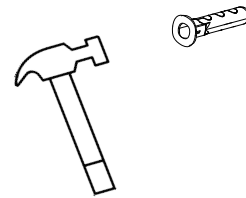

Install buttons in to place using the screws provided. The screw must be flush with the buttons surface.

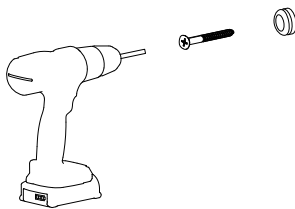

This drawing indicates proper installation of the buttons.

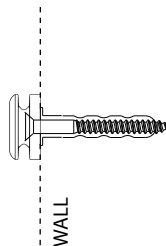

Carefully lift the mirror over the buttons until they enter the cavity in the mirror backing. Slowly lower and gently push down into place until clicks.

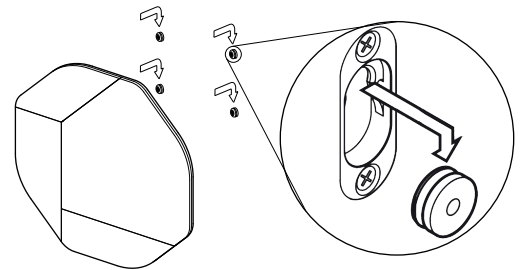

Enjoy!

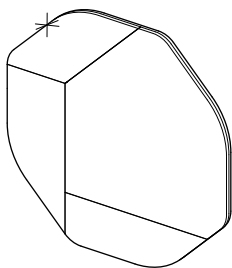

IMPORTANT CARE INSTRUCTIONS

Do not spray the cleaner directly on the glass - this will trap moisture behind the edge of the mirror and cause corrosion over time.

Spray a small amount of M.Co glass cleaner onto a microfiber cloth. Wipe the mirror in a circular motion. Use a dry part of the cloth to polish the surface of the mirror. Repeat until the surface of the glass is streakless.

We recommend using our custom M.CO mirror cleaner blend, formulated to work great without toxic chemicals.

WHAT'S IN THE CRATE?

M.CO

1 X MOUNTING TEMPLATE

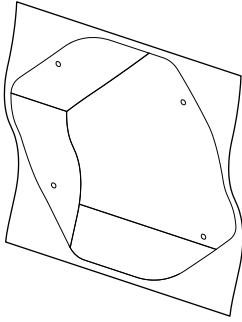

1 X M.CO MIRROR

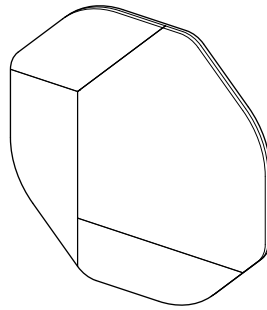

4 X MOUNTING BUTTONS



4 X #8 FLAT-HEAD SCREWS

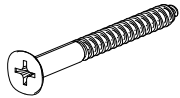

4 X DRYWALL ANCHORS

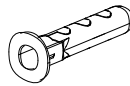

4 X CEMENT/BRICK/TILE ANCHORS

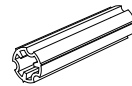

1 X MICROFIBER CLOTH

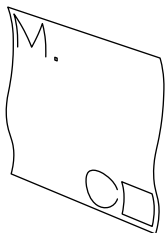

1 X MIRROR CLEANER

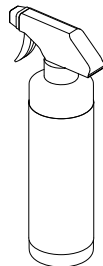

FOR INSTALLATION, YOU WILL NEED:



a drilling tool



hammer



tape

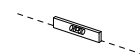

a leveling tool

MIRRORSCOLLECTIVE.COM

@MIRRORSCOLLECTIVE