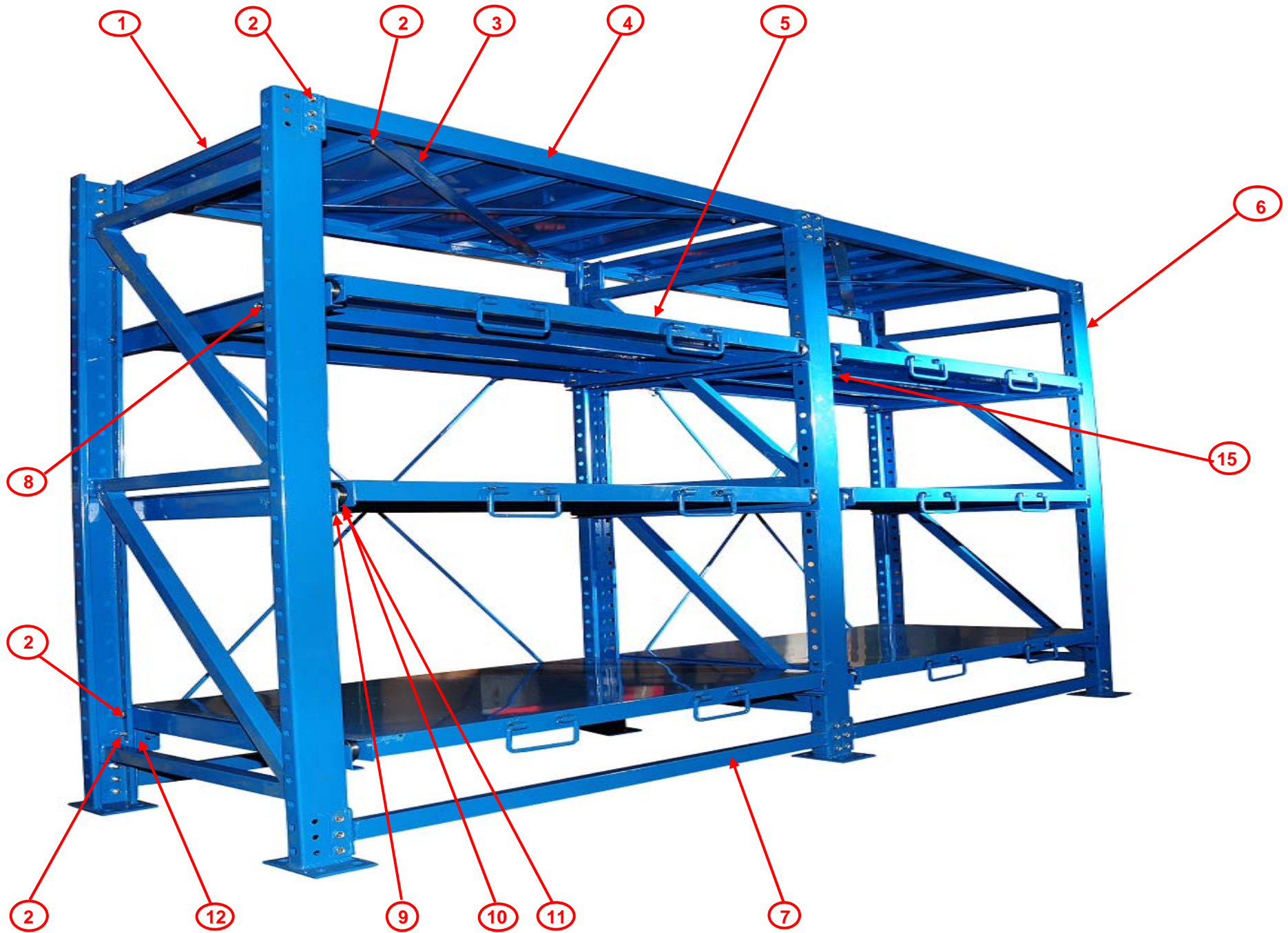
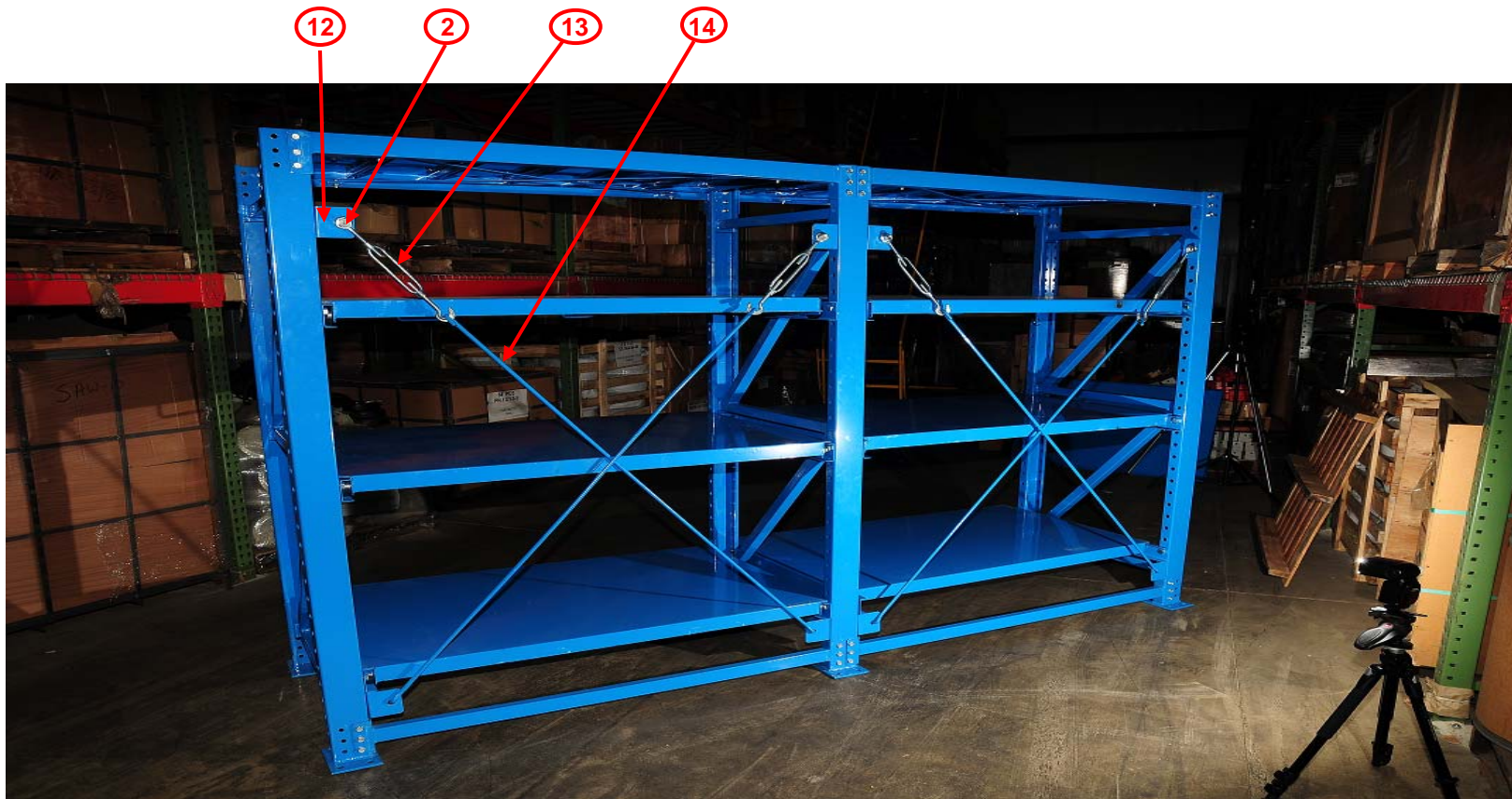

**DIAGRAM & PARTS LIST OF ASSEMBLED VRSOR-114**





1. Solid Steel Top Deck - 2 pcs.
2. M12-1.5x25mm bolt, M12 washer, M12 lock washer, & M12-1.5 nut - 88 pcs. each
3. X-braces for top deck - 4 pcs.
4. Top beam - 4 pcs.
5. Shelf - 6 pcs.
6. Upright - 3 pcs.
7. Bottom beam - 4 pcs.
8. Shelf Lock bolt M10-1.5x40mm bolt (2 per shelf) - 12 pcs.
9. Left & Right Roller Track - 6 Left & 6 Right
10. Ball Bearing for roll-out shelf (6305E-RZ) - 24 pcs.
11. Shaft, spacer, & M12-1.5 Nut PER BALL BEARING - 24 pcs.
12. X-Brace mounting bracket - 8 pcs.
13. Turn Buckle - 4 pcs.
14. X-Brace - 2 sets (2 cross bars per set)
15. Locking pin assembly for roll-out shelf (1 pin assembly per shelf) - 6 pcs.



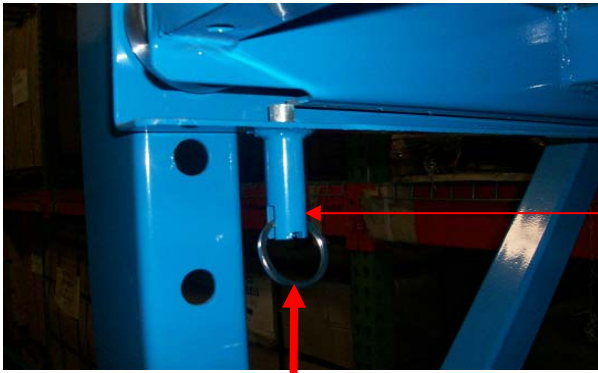

Roll-out shelf locking pin

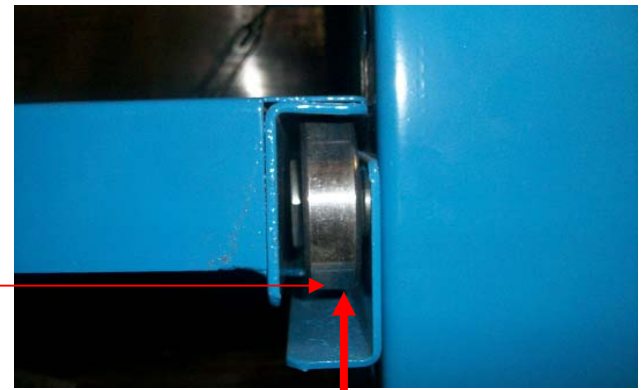

Roll-out shelf bearing assembly



Shelf Locking M10x40mm bolt (part # 8)



Turn Buckle (Part # 13)



X-Brace Mounting Bracket (Part # 12)

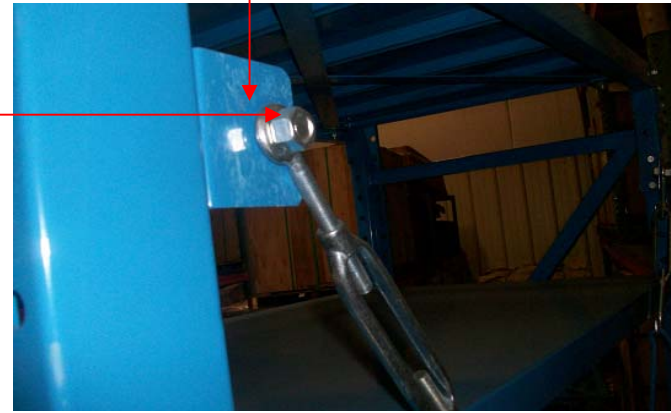

M12 bolt, lock washer  
& nut (Part # 2)

X-Brace cross bars part # 14

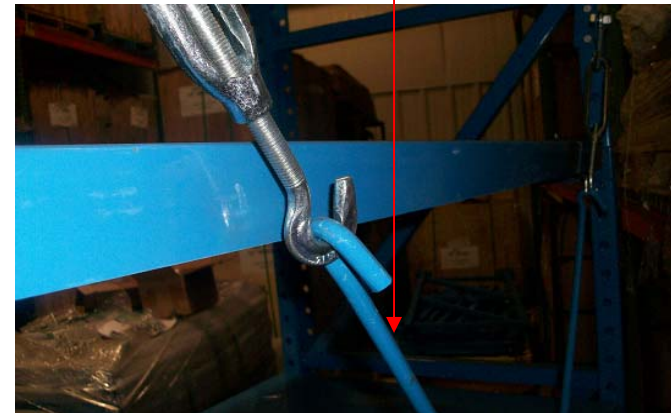

X-brace mounting bracket hardware  
(M12 bolts, nuts, lock washers & washers)





## **TECHNICAL DATA**

<b>Model Number</b>	<b>VRSOR-114</b>
<b>Total Uniform Capacity (TUC)</b>	<b>6,000 lb ( 2727.3kg)</b>
<b>Maximum Capacity per shelf</b>	<b>1,500 lb (681.8kg)</b>
<b>Overall Size (W x D x H)</b>	<b>114" x 32" x 80" (289.6cm x 81.3cm x 203.2cm)</b>
<b>Shelf Size (W x D)</b>	<b>52" x 32" (132.1cm x 81.3cm)</b>
<b>Number of Roll-out Shelves</b>	<b>6</b>
<b>Force to pull the shelf out</b>	<b>100% shelf extension with as little as 20 lb. of effort</b>
<b>Net Weight</b>	<b>900 lb. (409.1kg)</b>

**NOTE: 1" = 2.54cm  
2.2lb. = 1kg**

## **INSTALLATION**

**Units must be securely anchored to the floor and level. Use anchoring hardware selected by your building/facility engineer.**



### Installation

Installation requires lifting and manipulating components which individually might weigh as much as 102 pounds. We recommend that at least 3 people work together to install this heavy duty roll-out shelving.

1. Install the pallet rack on a level, even surface. Be certain to account for necessary aisle space, for example to accommodate lifting equipment, when selecting the installation location.
2. Position an upright frame piece in its desired location and mark the floor with the positions of the bolt holes in the foot pads (marked with arrows in FIG. 1 below).
3. To anchor the upright frame piece to the floor requires appropriately-matched anchor bolts selected by your building engineer. To match the diameter of the bolt holes in the foot pads of the upright frame pieces, anchor bolts should be  $\frac{1}{2}$  in. in diameter. Bolt length should be selected by your building engineer as well as the type of in-ground anchoring device. NOTE: 1in = 2.54cm

**FIG. 1:** Anchoring uprights to floor

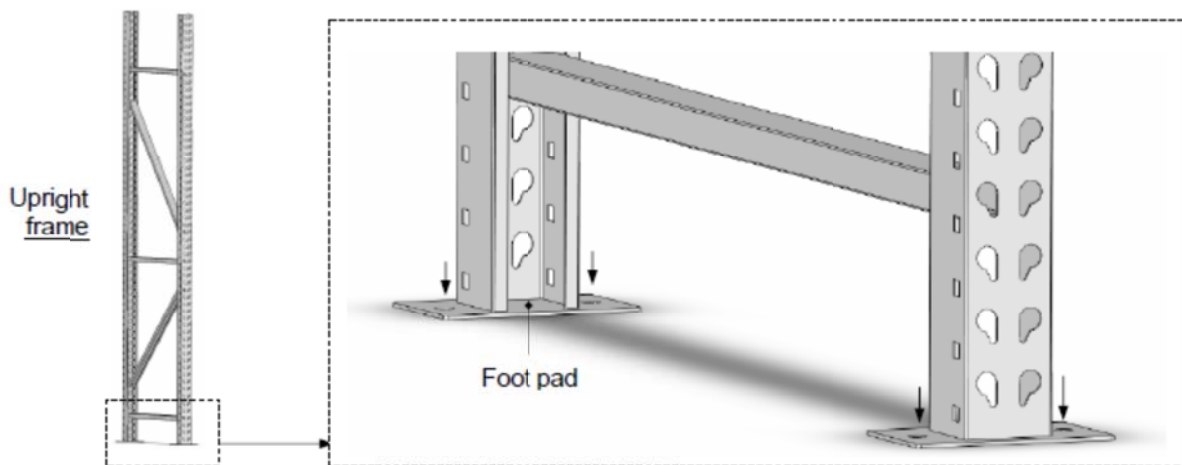

4. Drill holes for the anchor bolts and install the anchoring devices. Before bolting the upright frame to the ground, slide a lock washer followed by a flat washer onto each bolt; then slide the bolts through the bolt holes in the foot pads and into the anchoring device. Tighten the bolt to the anchor according to the instructions of the anchor bolt kit manufacturer.
5. Position the second upright frame piece, and mark the floor with the locations of the bolt holes. Repeat step 4 to anchor the upright to the floor.