

ECONOMY SPREADER BEAM - SBM-20-6

APPROX WEIGHT: 96.87 lbs.
DOES NOT INCLUDE WEIGHT OF POWER OR PACKAGING!!!

*** ANY ADDITIONS, DELETIONS, OR OMISSIONS MUST BE CORRECTED ON THIS DRAWING AS THIS DRAWING WILL BE CONSIDERED ALL INCLUSIVE ***

ALL GRAPHICS PROVIDED ARE FOR REFERENCE ONLY. IF CERTAIN DIMENSIONS ARE CRITICAL PLEASE VERIFY THOSE DIMENSIONS WITH YOUR SALESPERSON

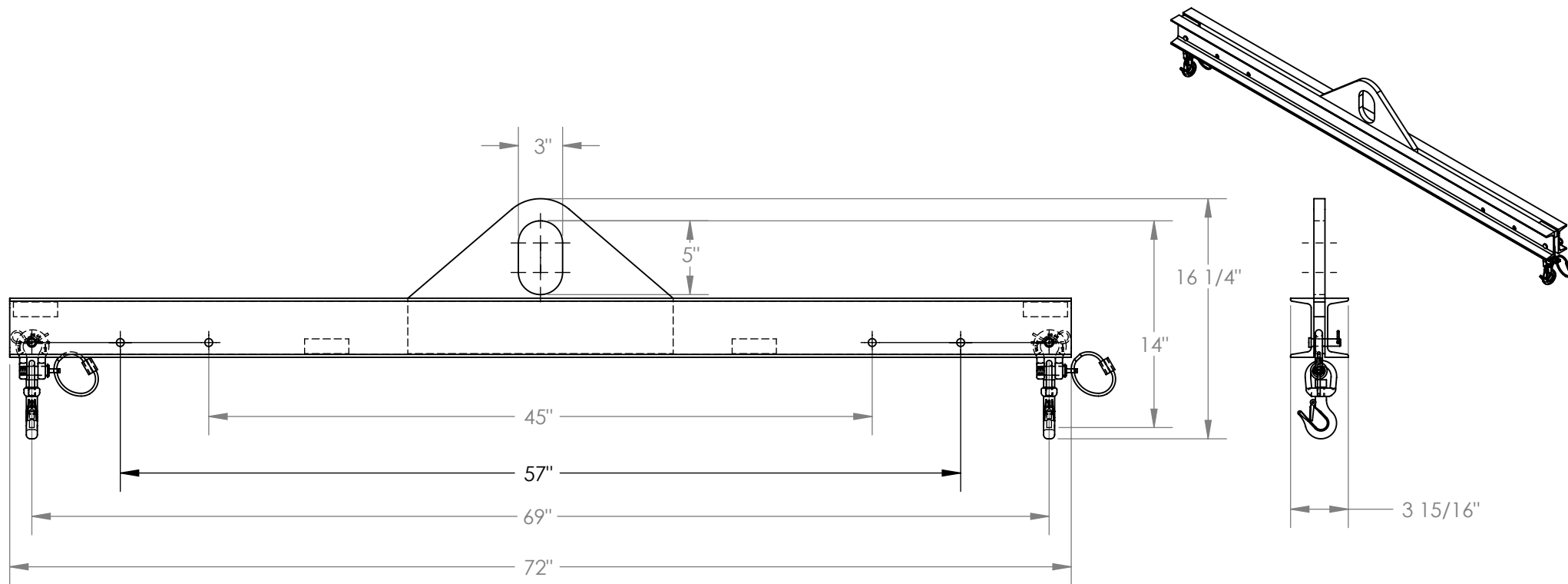

DIMENSION TOLERANCE $\pm 1/4$ "

A
P
P
R
O
V
A
L

I, THE UNDERSIGNED, AGREE THAT THE PRODUCT AS REPRESENTED SATISFIES DESIGN AND DIMENSION REQUIREMENTS. I ALSO ACKNOWLEDGE MY DUTY TO CONFIRM PRODUCT AND INSTALLATION COMPLIANCE WITH ALL APPLICABLE FEDERAL, STATE AND LOCAL REGULATIONS AND STANDARDS.

ANY MODIFIED UNITS ARE NON-RETURNABLE

[] As drawn [] As marked

Signed: _____ Date: _____

Printed Name: _____

LEAD TIME WILL START UPON RECEIPT OF SIGNED APPROVAL DRAWING

STANDARD FEATURES

- MODEL NUMBER IS SBM-20-6
- OVERALL WIDTH IS 3 15/16"
- OVERALL HEIGHT IS 16 1/4"
- OVERALL LENGTH IS 72"
- USABLE BAIL IS 3"x5"
- MINIMUM SPREAD IS 45"
- MAXIMUM SPREAD IS 69"
- HEADROOM IS 14"
- MAX CAPACITY IS 2000 LBS.

SPECIAL FEATURES

NONE

FOR INTERNAL USE ONLY PROJECT SIGN OFF	
SALES	
ENG.	
FAB.	
POWER	

DISTRIBUTOR'S NAME:		P.O.#
VESTIL MANUFACTURING		X
DRAWN BY: DEY		W.O.#
DATE: 12/17/10		X
REFERENCE: X	SCALE: 1:10	SALES: X
QUOTED LEAD TIME: X	QUOTE #	FILE NAME:
	X	08-007-177