

PNEUMATIC TIRE STEEL PLATFORM TRUCK- PNU-2472

APPROX WEIGHT: 268.78 lbs.
 DOES NOT INCLUDE WEIGHT OF POWER OR PACKAGING!!!

*** ANY ADDITIONS, DELETIONS, OR OMISSIONS MUST BE CORRECTED ON THIS DRAWING AS THIS DRAWING WILL BE CONSIDERED ALL INCLUSIVE ***
 ALL GRAPHICS PROVIDED ARE FOR REFERENCE ONLY. IF CERTAIN DIMENSIONS ARE CRITICAL PLEASE VERIFY THOSE DIMENSIONS WITH YOUR SALESPERSON

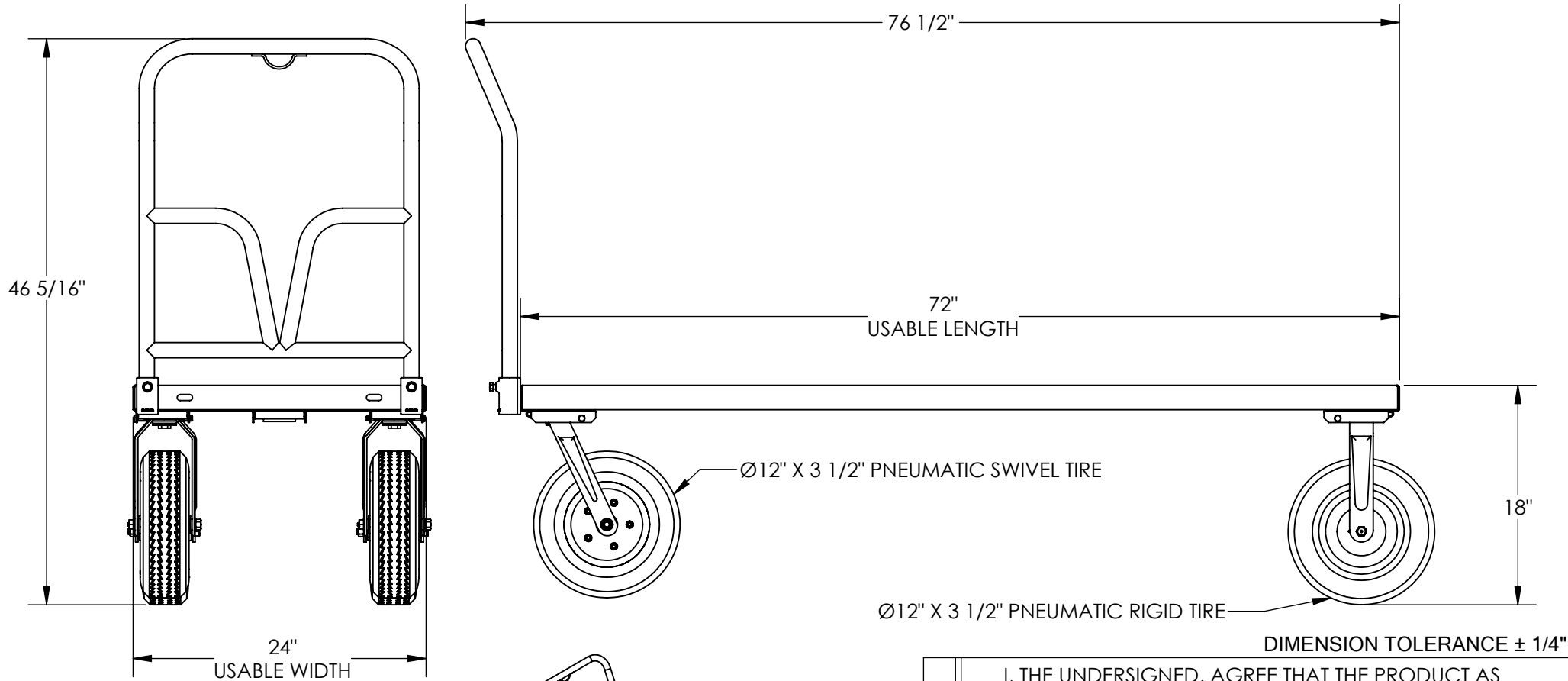

STANDARD FEATURES

- MODEL NUMBER IS PNU-2472
- CAPACITY: 1,500 LBS.
- DECK SIZE: 24" X 72"
- PLATFORM HEIGHT: 18"
- OVERALL HEIGHT IS 46 5/16"
- OVERALL LENGTH IS 76 1/2"
- Ø12" X 3 1/2" PNEUMATIC TIRE CASTERS
- 2- RIGID CASTERS
- 2- SWIVEL CASTERS
- TOUGH BAKED IN POWDER COAT BLUE FINISH

SPECIAL FEATURES

NONE

APPROVAL

I, THE UNDERSIGNED, AGREE THAT THE PRODUCT AS REPRESENTED SATISFIES DESIGN AND DIMENSION REQUIREMENTS. I ALSO ACKNOWLEDGE MY DUTY TO CONFIRM PRODUCT AND INSTALLATION COMPLIANCE WITH ALL APPLICABLE FEDERAL, STATE AND LOCAL REGULATIONS AND STANDARDS.
UNITS REQUIRING APPROVAL DRAWINGS OR MODIFIED ARE NON-RETURNABLE
 As drawn As marked

Signed: _____ Date: _____

Printed Name: _____

LEAD TIME WILL START UPON RECEIPT OF SIGNED APPROVAL DRAWING

DISTRIBUTOR'S NAME:		P.O.#
VESTIL MANUFACTURING		X
DRAWN BY: TAL		W.O.#
DATE: 6/15/2021		X
REFERENCE: X	SCALE: 1:12	SALES: X
QUOTED LEAD TIME: X	QUOTE #	FILE NAME:
	X	33-007-395