

LIFT MASTER BOOM, LIFT MASTER ONE, NON-TELESCOPING BOOM - LM-1NT-4-36

APPROX WEIGHT: 374.93 lbs.
DOES NOT INCLUDE WEIGHT OF POWER OR PACKAGING!!!

*** ANY ADDITIONS, DELETIONS, OR OMISSIONS MUST BE CORRECTED ON THIS DRAWING AS THIS DRAWING WILL BE CONSIDERED ALL INCLUSIVE ***
ALL GRAPHICS PROVIDED ARE FOR REFERENCE ONLY. IF CERTAIN DIMENSIONS ARE CRITICAL PLEASE VERIFY THOSE DIMENSIONS WITH YOUR SALESPERSON

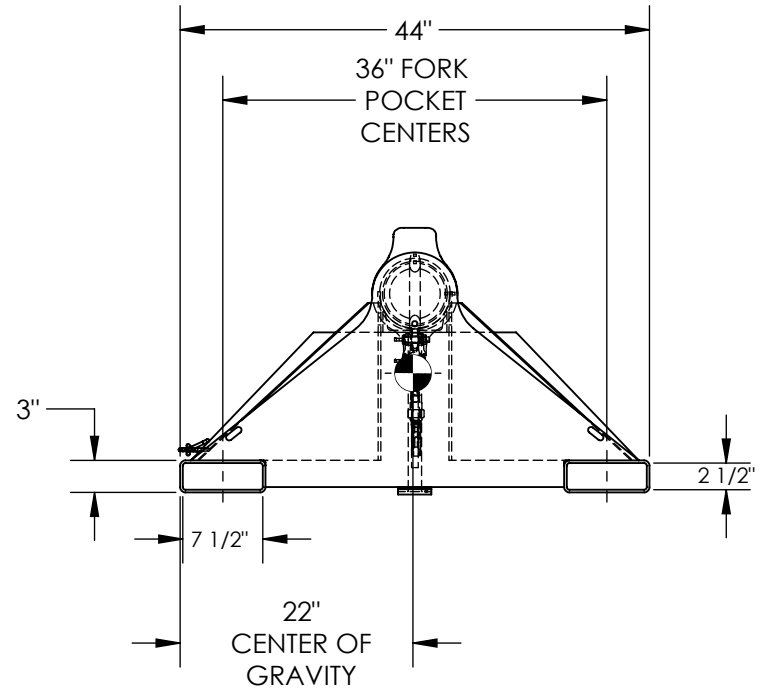
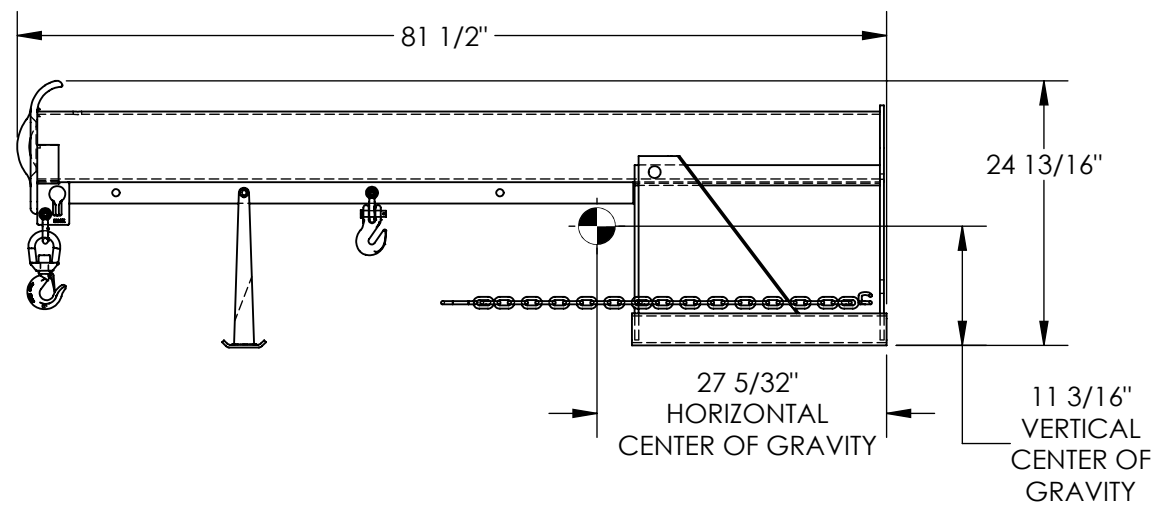

*--MAXIMUM SINGLE HOOK CAPACITIES

DISTANCE	36"	48"	60"	72"	78"
CAPACITY	4000	3750	3500	3250	3000

STANDARD FEATURES

- MODEL NUMBER IS LM-1NT-4-36
- CAPACITY IS 4,000 LBS
- LOST LOAD - 380 LBS
- OVERALL HEIGHT - 24 13/16"
- OVERALL LENGTH - 81 1/2"
- OVERALL WIDTH IS 44"
- 36" MINIMUM HOOK POINT
- 78" MAXIMUM HOOK POINT
- USABLE FORK POCKET - 2 1/2"x7 1/2"
- 36" FORK POCKET CENTERS
- EFFECTIVE THICKNESS: LESS THAN 1"

SPECIAL FEATURES

NONE

DIMENSION TOLERANCE ± 1/4"

APPROVAL	I, THE UNDERSIGNED, AGREE THAT THE PRODUCT AS REPRESENTED SATISFIES DESIGN AND DIMENSION REQUIREMENTS. I ALSO ACKNOWLEDGE MY DUTY TO CONFIRM PRODUCT AND INSTALLATION COMPLIANCE WITH ALL APPLICABLE FEDERAL, STATE AND LOCAL REGULATIONS AND STANDARDS.	
	ANY MODIFIED UNITS ARE NON-RETURNABLE	
	[] As drawn [] As marked	
Signed: _____		Date: _____
Printed Name: _____		
LEAD TIME WILL START UPON RECEIPT OF SIGNED APPROVAL DRAWING		

NEVER EXCEED LOAD CENTER RATING PER FORK TRUCK MANUFACTURER'S GUIDELINES.
DO NOT USE THIS FORK TRUCK ATTACHEMENT IF LOAD WILL EXCEED FORK TRUCK MANUFACTURER'S LOAD CENTER RATING.

FOR INTERNAL USE ONLY PROJECT SIGN OFF	
SALES	
ENG.	
FAB.	
POWER	

DISTRIBUTOR'S NAME:		P.O.#
VESTIL MANUFACTURING		X
DRAWN BY: BCN		W.O.#
DATE: 6/1/2016		X
REFERENCE: X	SCALE: 1:18	SALES: X
QUOTED LEAD TIME: X	QUOTE #	FILE NAME:
	X	08-007-321