

STANDARD SLOPE LADDER, NO HANDRAIL, 4-STEP, GRIP STRUT - LAD-PW-26-4-G-NHR

APPROX WEIGHT: 72.59 lbs.
DOES NOT INCLUDE WEIGHT OF POWER OR PACKAGING!!!

*** ANY ADDITIONS, DELETIONS, OR OMISSIONS MUST BE CORRECTED ON THIS DRAWING AS THIS DRAWING WILL BE CONSIDERED ALL INCLUSIVE ***
ALL GRAPHICS PROVIDED ARE FOR REFERENCE ONLY. IF CERTAIN DIMENSIONS ARE CRITICAL PLEASE VERIFY THOSE DIMENSIONS WITH YOUR SALESPERSON

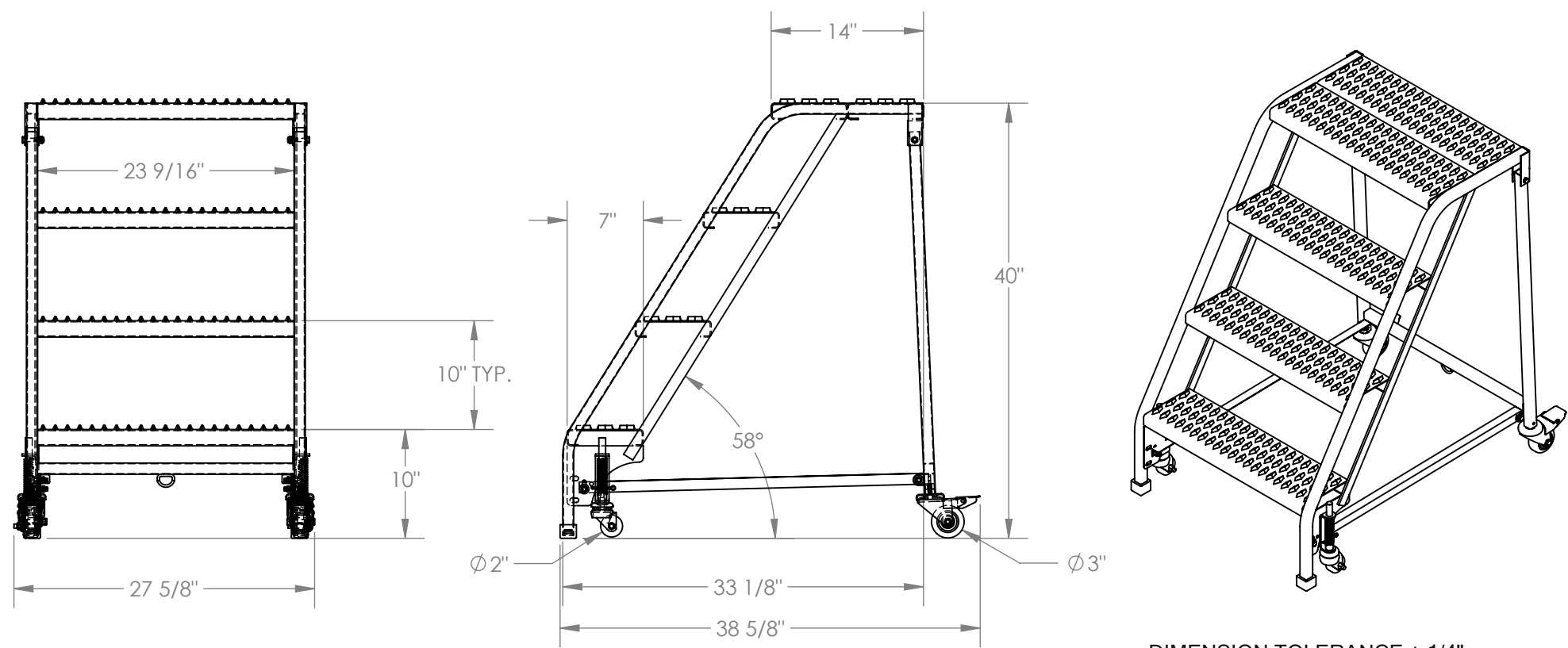

DIMENSION TOLERANCE ± 1/4"

STANDARD FEATURES

- MODEL NUMBER IS LAD-PW-26-4-G-NHR
- OVERALL WIDTH IS 27 5/8"
- USABLE WIDTH IS 23 9/16"
- OVERALL LENGTH IS 38 5/8"
- USABLE LENGTH IS 33 1/8"
- OVERALL HEIGHT IS 40"
- PLATFORM HEIGHT IS 40"
- COLOR IS VESTIL BLUE
- STEP TYPE IS GRIP STRUT
- CLIMB ANGLE IS 58°
- STEP DEPTH IS 7"
- PLATFORM DEPTH IS 14"
- MAX CAPACITY IS 350 LBS
- FRONT Ø2" DIRECTIONAL SPRING-LOADED SWIVEL CASTERS
- REAR Ø3" SWIVEL LOCK CASTERS

NOTE

SOME ASSEMBLY REQUIRED

SPECIAL FEATURES

NONE

APPROVAL

I, THE UNDERSIGNED, AGREE THAT THE PRODUCT AS REPRESENTED SATISFIES DESIGN AND DIMENSION REQUIREMENTS. I ALSO ACKNOWLEDGE MY DUTY TO CONFIRM PRODUCT AND INSTALLATION COMPLIANCE WITH ALL APPLICABLE FEDERAL, STATE AND LOCAL REGULATIONS AND STANDARDS.
ALL SPECIAL UNITS ARE NON-RETURNABLE
[] As drawn [] As marked

Signed: _____ Date: _____

LEAD TIME WILL START UPON RECEIPT OF SIGNED APPROVAL DRAWING

FOR INTERNAL USE ONLY PROJECT SIGN OFF	
SALES	
ENG.	
FAB.	
POWER	

DISTRIBUTOR'S NAME:		P.O.#
VESTIL MANUFACTURING		X
W.O.#		X
DRAWN BY:	B.NOETHNAGEL	DATE: 9/1/2015
REFERENCE:	X	SCALE: 1:14
QUOTED LEAD TIME:	X	QUOTE #
		X
FILE NAME:	44-007-432	