

# STANDARD SLOPE LADDER, 5-STEP, GRIP STRUT- LAD-PW-18-5-G

APPROX WEIGHT: 97.49 lbs.  
DOES NOT INCLUDE WEIGHT OF POWER OR PACKAGING!!!

\*\*\* ANY ADDITIONS, DELETIONS, OR OMISSIONS MUST BE CORRECTED ON THIS DRAWING AS THIS DRAWING WILL BE CONSIDERED ALL INCLUSIVE \*\*\*

ALL GRAPHICS PROVIDED ARE FOR REFERENCE ONLY. IF CERTAIN DIMENSIONS ARE CRITICAL PLEASE VERIFY THOSE DIMENSIONS WITH YOUR SALESPERSON

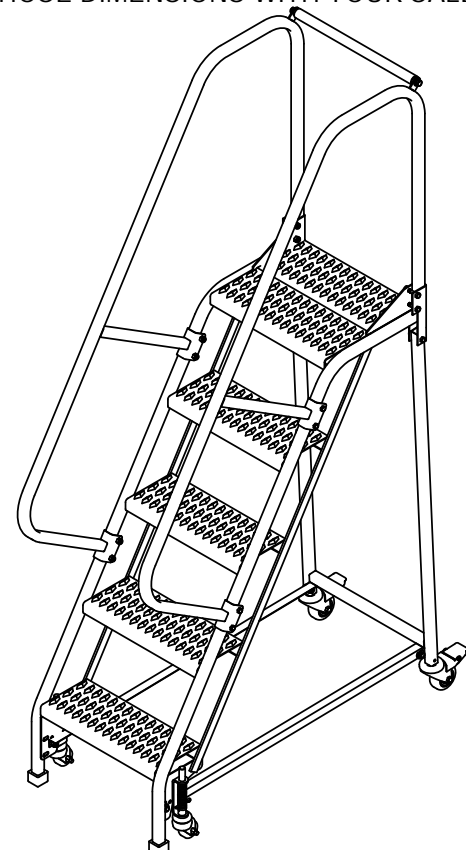
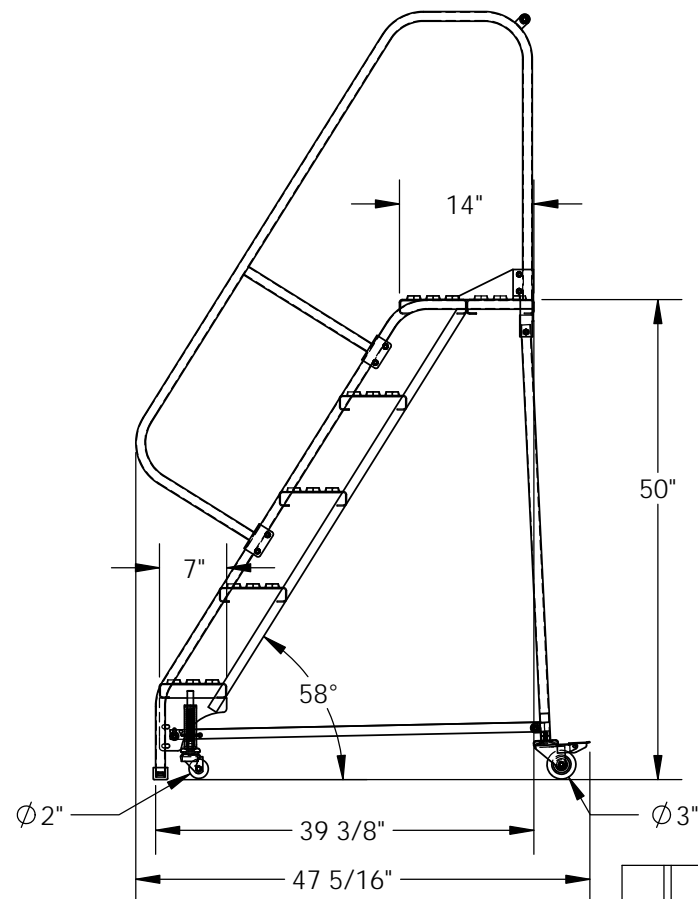
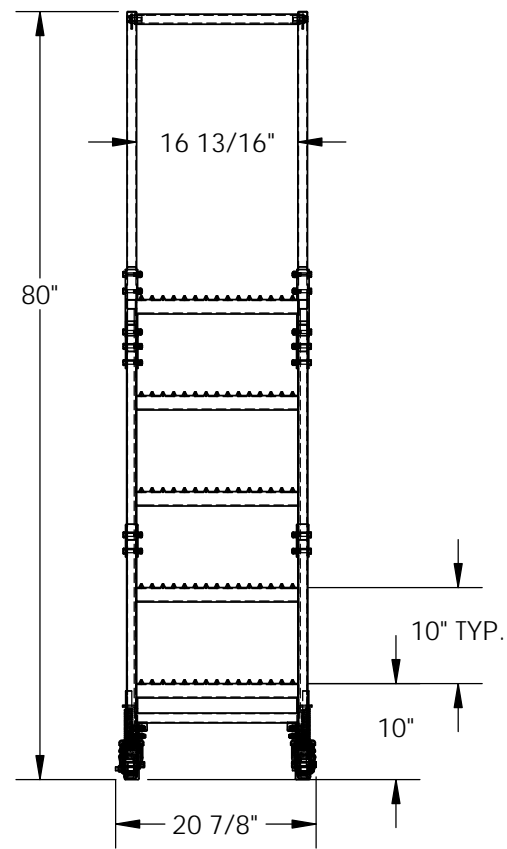

DIMENSION TOLERANCE ± 1/4"

## STANDARD FEATURES

- MODEL NUMBER IS LAD-PW-18-5-G
- OVERALL WIDTH IS 20 7/8"
- USABLE WIDTH IS 16 13/16"
- OVERALL LENGTH IS 47 5/16"
- USABLE LENGTH IS 39 3/8"
- OVERALL HEIGHT IS 80"
- PLATFORM HEIGHT IS 50"
- COLOR IS VESTIL BLUE
- STEP TYPE IS GRIP STRUT
- CLIMB ANGLE IS 58°
- STEP DEPTH IS 7"
- PLATFORM DEPTH IS 14"
- MAX CAPACITY IS 350 LBS
- FRONT Ø2" DIRECTIONAL SPRING-LOADED SWIVEL CASTERS
- REAR Ø3" SWIVEL LOCK CASTERS

## NOTE

SOME ASSEMBLY REQUIRED  
TOOL TRAY SOLD SEPARATELY

## SPECIAL FEATURES

NONE

APPROVAL

I, THE UNDERSIGNED, AGREE THAT THE PRODUCT AS REPRESENTED SATISFIES DESIGN AND DIMENSION REQUIREMENTS. I ALSO ACKNOWLEDGE MY DUTY TO CONFIRM PRODUCT AND INSTALLATION COMPLIANCE WITH ALL APPLICABLE FEDERAL, STATE AND LOCAL REGULATIONS AND STANDARDS.  
**ALL SPECIAL UNITS ARE NON-RETURNABLE**  
[ ] As drawn [ ] As marked

Signed: \_\_\_\_\_ Date: \_\_\_\_\_

LEAD TIME WILL START UPON RECEIPT OF SIGNED APPROVAL DRAWING

FOR INTERNAL USE ONLY PROJECT SIGN OFF	
SALES	
ENG.	
FAB.	
POWER	

DISTRIBUTOR'S NAME:		P.O.#
VESTIL MANUFACTURING		X
DRAWN BY:	DATE:	W.O.#
B.NOETHNAGEL	9/2/2015	X
REFERENCE:	SCALE:	SALES:
X	1:20	X
QUOTED LEAD TIME:	QUOTE #	FILE NAME:
X	X	44-007-451