

ALUMINUM TRUCK DOCKPLATE - E-7230

APPROX WEIGHT: 90.92 lbs.
 DOES NOT INCLUDE WEIGHT OF POWER OR PACKAGING!!!

*** ANY ADDITIONS, DELETIONS, OR OMISSIONS MUST BE CORRECTED ON THIS DRAWING AS THIS DRAWING WILL BE CONSIDERED ALL INCLUSIVE ***

ALL GRAPHICS PROVIDED ARE FOR REFERENCE ONLY. IF CERTAIN DIMENSIONS ARE CRITICAL PLEASE VERIFY THOSE DIMENSIONS WITH YOUR SALESPERSON

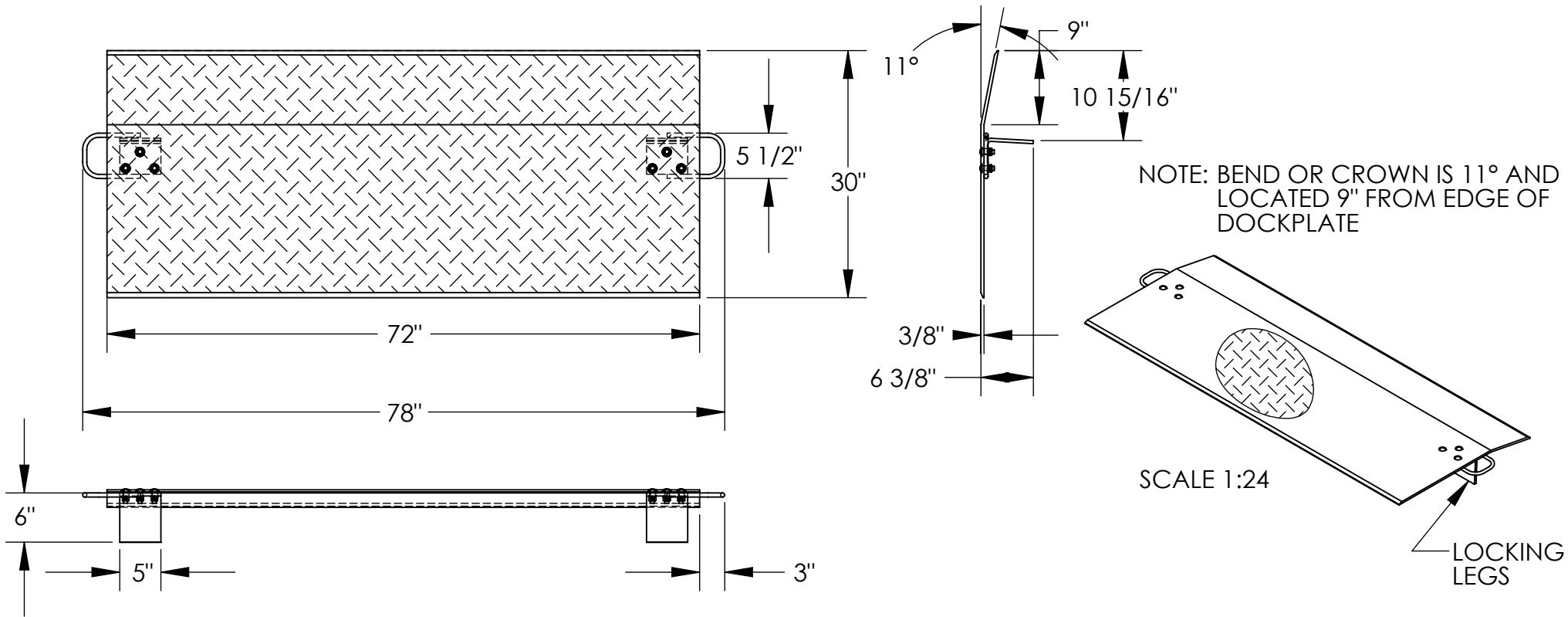

STANDARD FEATURES

- MODEL NUMBER IS E-7230
- CAPACITY IS 5,400 LBS
- OVERALL WIDTH IS 78"
- DECK WIDTH IS 72"
- OVERALL LENGTH IS 30"
- OVERALL HEIGHT IS 6 3/8"
- THICKNESS IS 3/8"
- HANDLES ARE 5 1/2" x 3"
- LOCKING LEGS ARE 5" x 6"

SPECIAL FEATURES

NONE

DIMENSION TOLERANCE ± 1/4"

APPROVAL

I, THE UNDERSIGNED, AGREE THAT THE PRODUCT AS REPRESENTED SATISFIES DESIGN AND DIMENSION REQUIREMENTS. I ALSO ACKNOWLEDGE MY DUTY TO CONFIRM PRODUCT AND INSTALLATION COMPLIANCE WITH ALL APPLICABLE FEDERAL, STATE AND LOCAL REGULATIONS AND STANDARDS.

UNITS REQUIRING APPROVAL DRAWINGS OR MODIFIED ARE NON-RETURNABLE

[] As drawn [] As marked

Signed: _____ Date: _____

Printed Name: _____

LEAD TIME WILL START UPON RECEIPT OF SIGNED APPROVAL DRAWING

DISTRIBUTOR'S NAME:		P.O.#
VESTIL MANUFACTURING		X
DRAWN BY: ADL		W.O.#
DATE: 1/19/06		X
REFERENCE: X	SCALE: 1:18	SALES: X
QUOTED LEAD TIME: X	QUOTE #	FILE NAME:
	X	12-007-063