

ALUMINUM PALLET DOLLY- DOL-4242-6NT

APPROX WEIGHT: 75.06 lbs.
 DOES NOT INCLUDE WEIGHT OF POWER OR PACKAGING!!!

ANY ADDITIONS, DELETIONS, OR OMISSIONS MUST BE CORRECTED ON THIS DRAWING AS THIS DRAWING WILL BE CONSIDERED ALL INCLUSIVE

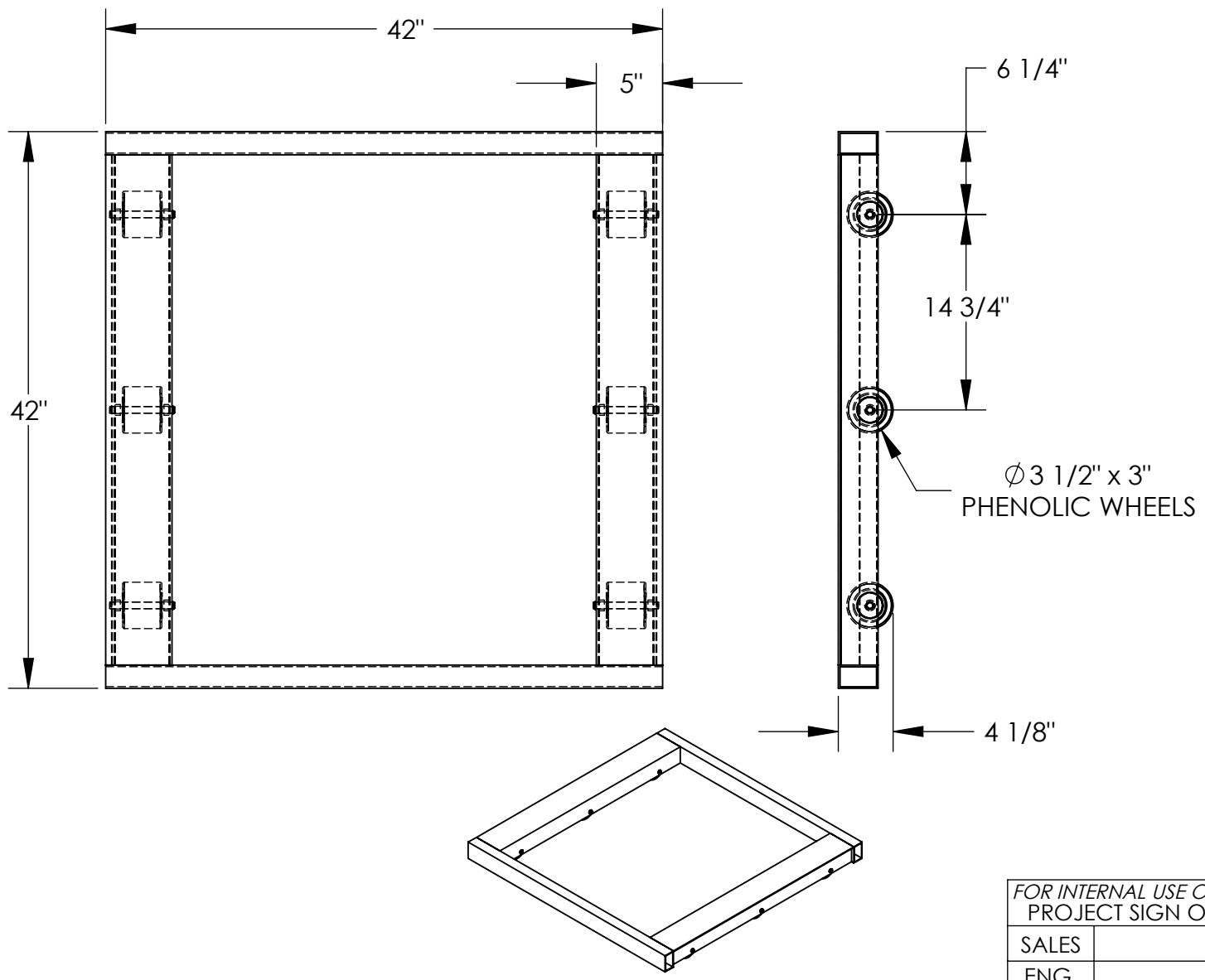

FOR INTERNAL USE ONLY PROJECT SIGN OFF	
SALES	
ENG.	
FAB.	
POWER	

ALL GRAPHICS PROVIDED ARE FOR REFERENCE ONLY. IF CERTAIN DIMENSIONS ARE CRITICAL PLEASE VERIFY THOSE DIMENSIONS WITH YOUR SALESPERSON

STANDARD FEATURES

- MODEL NUMBER IS DOL-4242-6NT
- CAPACITY IS 4,000 LBS.
- OVERALL WIDTH IS 42"
- OVERALL LENGTH IS 42"
- OVERALL HEIGHT IS 4 1/8"
- 6 ROLLERS Ø 3 1/2" x 3", PHENOLIC
- NON-TILT STYLE
- ALUMINUM CONSTRUCTION

SPECIAL FEATURES

NONE

APPROVAL	I, THE UNDERSIGNED, AGREE THAT THE PRODUCT AS REPRESENTED SATISFIES DESIGN AND DIMENSION REQUIREMENTS. I ALSO ACKNOWLEDGE MY DUTY TO CONFIRM PRODUCT AND INSTALLATION COMPLIANCE WITH ALL APPLICABLE FEDERAL, STATE AND LOCAL REGULATIONS AND STANDARDS.	
	ANY MODIFIED UNITS ARE NON-RETURNABLE	
	[] As drawn [] As marked	
	Signed: _____ Date: _____	
	Printed Name: _____	
<i>LEAD TIME WILL START UPON RECEIPT OF SIGNED APPROVAL DRAWING</i>		

DISTRIBUTOR'S NAME:		P.O.#
VESTIL MANUFACTURING		X
		W.O.#
DRAWN BY: JBD		X
DATE: 8/11/08		SALES:
REFERENCE: X		FILE NAME:
SCALE: 1:12		16-007-098
QUOTED LEAD TIME: X	QUOTE #	
	X	