

CROSS OVER LADDER, VERTICAL - COLV-4-46-20

APPROX WEIGHT: 220.44 lbs.
DOES NOT INCLUDE WEIGHT OF POWER OR PACKAGING!!!

*** ANY ADDITIONS, DELETIONS, OR OMISSIONS MUST BE CORRECTED ON THIS DRAWING AS THIS DRAWING WILL BE CONSIDERED ALL INCLUSIVE ***
ALL GRAPHICS PROVIDED ARE FOR REFERENCE ONLY. IF CERTAIN DIMENSIONS ARE CRITICAL PLEASE VERIFY THOSE DIMENSIONS WITH YOUR SALESPERSON

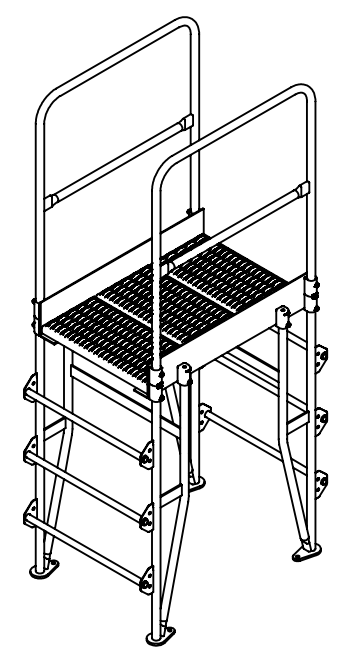
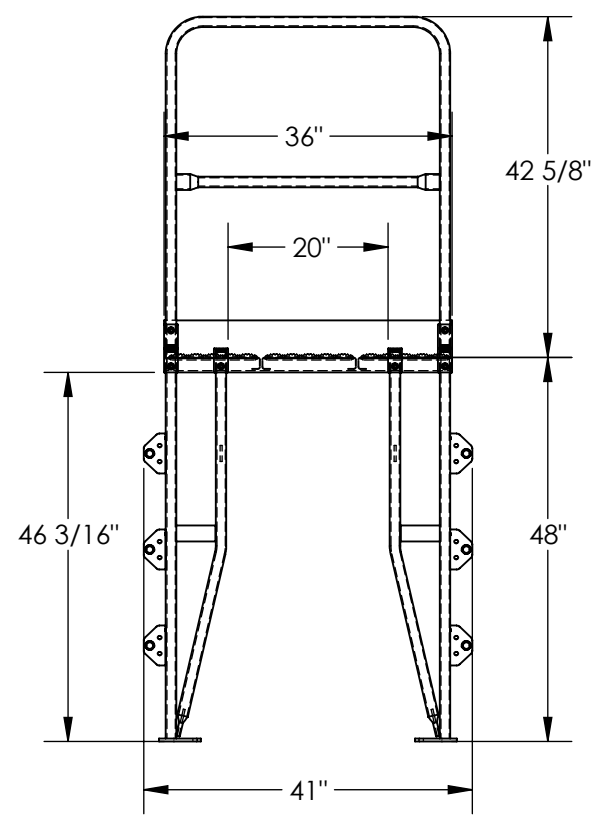
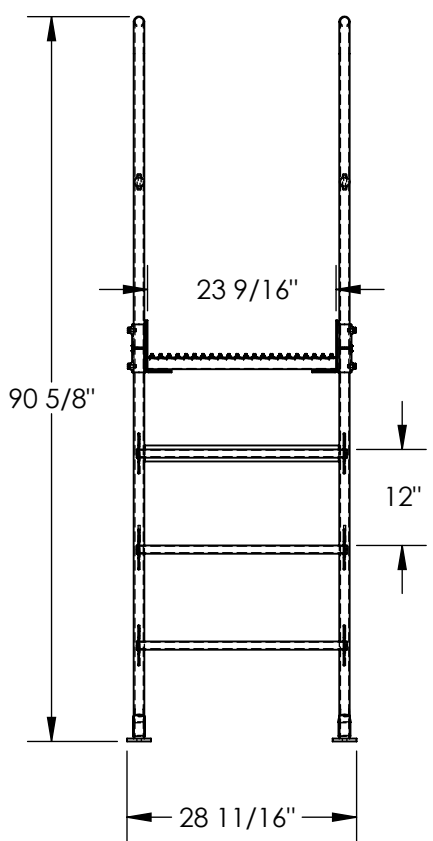

DIMENSION TOLERANCE ± 1/4"

STANDARD FEATURES

- MODEL NUMBER IS COLV-4-46-20
- OVERALL SIZE IS 28 11/16"W x 41" L x 90 5/8" H
- CLEARANCE SPAN IS 20" x 46 3/16"
- TOP PLATFORM HEIGHT IS 48"
- STEP HEIGHT SPACING IS 12"
- STEP & PLATFORM WIDTH IS 23 9/16"
- HANDRAIL HEIGHT IS 42 5/8"
- PLATFORM LENGTH IS 36"
- ALL PLATFORM STEPS ARE SERRATED STEEL
- TOP HALF OF STEPS COVERED IN GRIP MATERIAL
- KNOCK DOWN HANDRAILING (UNIT SHIPS KNOCKED DOWN, ASSEMBLY REQUIRED)
- UNIFORM CAPACITY IS 500 LBS
- TOUGH BAKED IN POWDER COATED YELLOW FINISH

NOTE

- UNIT MUST BE ANCHORED TO THE FLOOR!!!
- Ø9/16" MOUNTING HOLES
- 4 TOTAL MOUNTING HOLES PER STANDARD UNIT
- 1 MOUNTING HOLE PER CORNER BRACKET

SPECIAL FEATURES

NONE

FOR INTERNAL USE ONLY PROJECT SIGN OFF	
SALES	
ENG.	
FAB.	
POWER	

APPROVAL	I, THE UNDERSIGNED, AGREE THAT THE PRODUCT AS REPRESENTED SATISFIES DESIGN AND DIMENSION REQUIREMENTS. I ALSO ACKNOWLEDGE MY DUTY TO CONFIRM PRODUCT AND INSTALLATION COMPLIANCE WITH ALL APPLICABLE FEDERAL, STATE AND LOCAL REGULATIONS AND STANDARDS.	
	ANY MODIFIED UNITS ARE NON-RETURNABLE	
	[] As drawn [] As marked	
	Signed: _____	Date: _____
	Printed Name: _____	
LEAD TIME WILL START UPON RECEIPT OF SIGNED APPROVAL DRAWING		

DISTRIBUTOR'S NAME:		P.O.#
VESTIL MANUFACTURING		X
		W.O.#
DRAWN BY: BCN	DATE: 5/21/2018	X
REFERENCE: X	SCALE: 1:24	FILE NAME:
QUOTED LEAD TIME: X	QUOTE # X	44-007-606