

LOW PROFILE FOOT PUMP HYDRAULIC SCISSOR LIFT CART - CART-LP-2000-2040-FP

APPROX WEIGHT: 385 lbs.
DOES NOT INCLUDE WEIGHT OF POWER OR PACKAGING!!!

*** ANY ADDITIONS, DELETIONS, OR OMISSIONS MUST BE CORRECTED ON THIS DRAWING AS THIS DRAWING WILL BE CONSIDERED ALL INCLUSIVE ***
ALL GRAPHICS PROVIDED ARE FOR REFERENCE ONLY. IF CERTAIN DIMENSIONS ARE CRITICAL PLEASE VERIFY THOSE DIMENSIONS WITH YOUR SALESPERSON

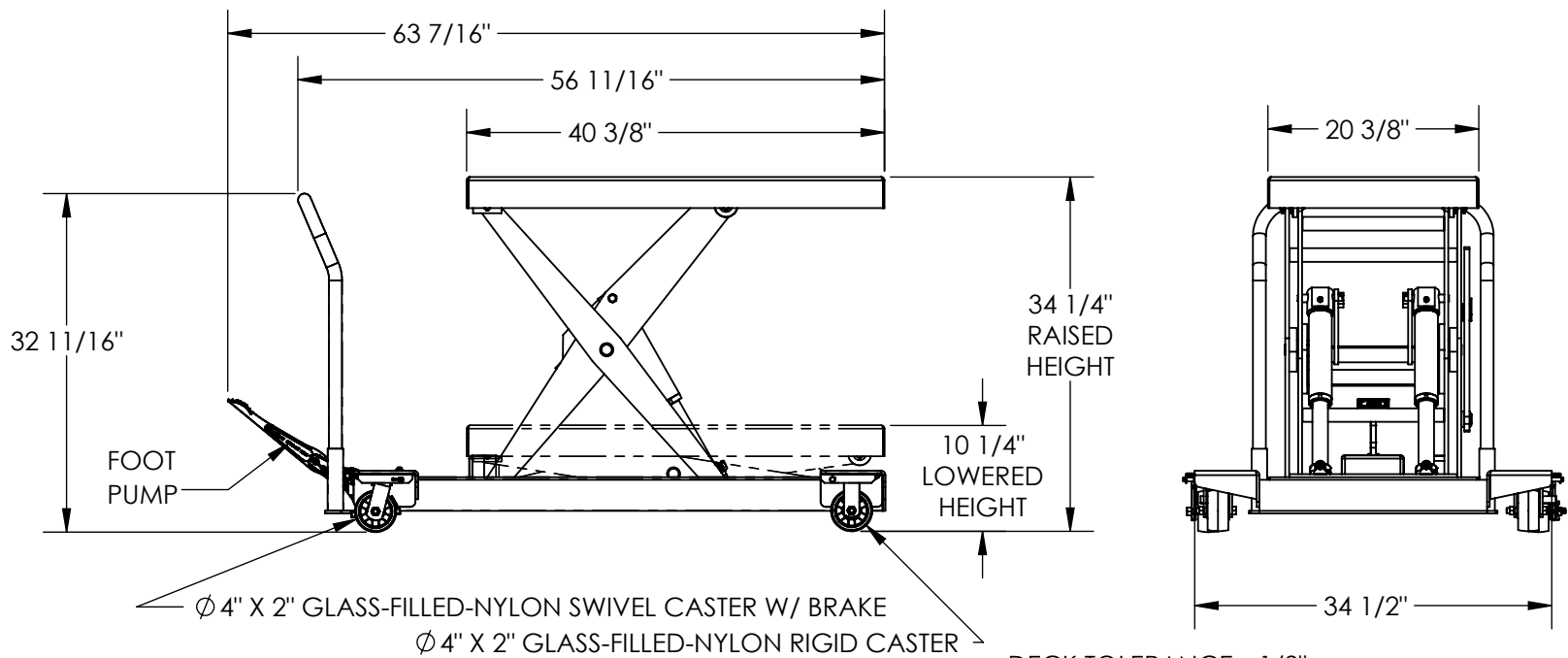

DECK TOLERANCE ± 1/2"
TABLE HEIGHT TOLERANCES ± 1/2"
DECK FLATNESS ± 1/4"
DIMENSION TOLERANCE ± 1/4"

STANDARD FEATURES

- MODEL NUMBER IS CART-LP-2000-2040-FP
- OVERALL WIDTH: 34 1/2"
- USABLE WIDTH: 20 3/8"
- OVERALL LENGTH: 63 7/16"
- USABLE LENGTH: 40 3/8"
- RAISED HEIGHT: 34 1/4"
- LOWERED HEIGHT: 10 1/4"
- Ø 4" X 2" GLASS-FILLED-NYLON RIGID CASTER
- Ø 4" X 2" GLASS-FILLED-NYLON SWIVEL CASTER W/ BRAKE
- TABLE CAPACITY (EVENLY DISTRIBUTED)
- MAX CAPACITY IS 2,000 LBS
- SAFETY MAINTENANCE PROPS, DISPLACEMENT
- STYLE CYLINDERS INSTALLED ROD DOWN
- EMERGENCY SAFETY STOP HYDRAULIC FUSES
- UPPER TRAVEL LIMIT SWITCH
- DURABLE LIQUID PAINT BLUE FINISH

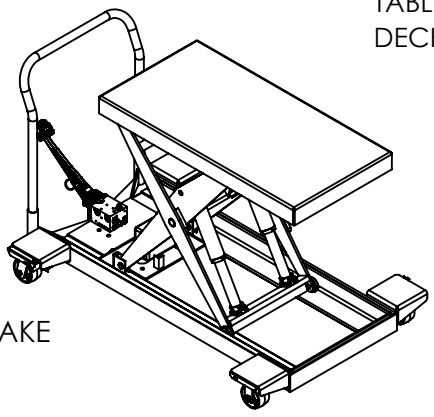

SPECIAL FEATURES

NONE

A P P R O V A L

I, THE UNDERSIGNED, AGREE THAT THE PRODUCT AS REPRESENTED SATISFIES DESIGN AND DIMENSION REQUIREMENTS. I ALSO ACKNOWLEDGE MY DUTY TO CONFIRM PRODUCT AND INSTALLATION COMPLIANCE WITH ALL APPLICABLE FEDERAL, STATE AND LOCAL REGULATIONS AND STANDARDS.

UNITS REQUIRING APPROVAL DRAWINGS OR MODIFIED ARE NON-RETURNABLE

As drawn As marked

Signed: _____ Date: _____

Printed Name: _____

LEAD TIME WILL START UPON RECEIPT OF SIGNED APPROVAL DRAWING

FOR INTERNAL USE ONLY PROJECT SIGN OFF	
SALES	
ENG.	
FAB.	
POWER	

DISTRIBUTOR'S NAME:		P.O.#
VESTIL MANUFACTURING		X
DRAWN BY: CRA	DATE: 06/14/2019	W.O.#
REFERENCE: X	SCALE: 1:18	X
QUOTED LEAD TIME: X	QUOTE #	FILE NAME:
	X	01-007-406