



by Stevens Industries, Inc.
 704 West Main St.
 Teutopolis, IL 62467
 P: 800.350.3270
 P: 217-857-7100 • F: 217-857-7101
 www.totmate.com

TM9428R TM9429R

ATTENTION

Please unpack and assemble in an area away from children's activities. Remove all tools and excess materials from work area after assembly of unit is complete. Dispose of pallet and packaging materials in an environmentally friendly manner. If any parts are missing or damaged, please call Stevens for immediate parts replacement (1-800-350-3270). When ordering parts, give the Model Number and Color of the unit.



CAUTION – CHOKING HAZARD

Adult assembly required due to presence of small parts and sharp edges.



**TM9428R
 TM9429R**
 My Place™ Rectangular Table

TM9428R Parts List			
ITEM	QTY	DESCRIPTION	REPLACEMENT ITEM #
1	1	TOP 30 x 60	3111-0067
2	4	Adj. Leg Upper Set of 4	0261-1469000000
3	4	Adj. Leg Lower 13-22" Set of 4	0261-1470000820
4	8	Table Leg Clip	0263-1510
5	24	Screw PhFI #10 X 1.00	0563-0643 Bag of 25
6	8	Leg Screw	

TM9429R Parts List			
ITEM	QTY	DESCRIPTION	REPLACEMENT ITEM #
1	1	TOP 30 x 60	3111-0067
2	4	Adj. Leg Upper Set of 4	0261-1469000000
3	4	Adj. Leg Lower 20-29" Set of 4	0261-1471000820
4	8	Table Leg Clip	0263-1510
5	24	Screw PhFI #10 X 1.00	0563-0643 Bag of 25
6	8	Leg Screw	

2-PERSON ASSEMBLY RECOMMENDED.

IMPORTANT!

Be sure to keep all parts supported during assembly to avoid damage. Do not over-tighten screws or it will damage the pre-drilled holes; snug fit is adequate.

HARDWARE INCLUDED (other hardware is pre-installed)

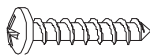

Leg Screw (6)

NOTE: Phillips screwdriver required but not included.

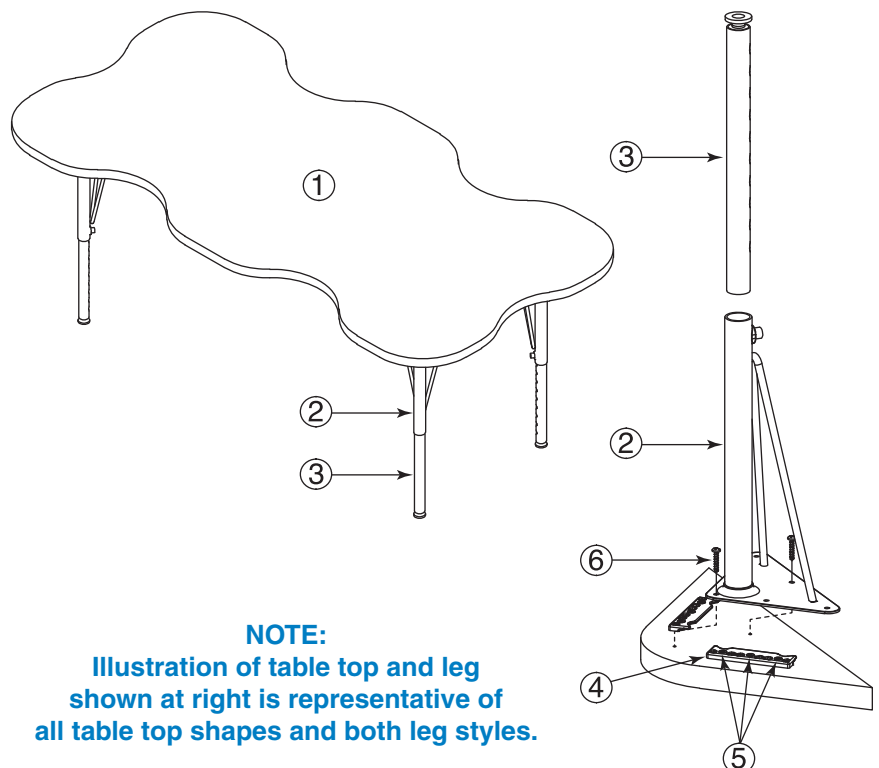

NOTE:

Illustration of table top and leg shown at right is representative of all table top shapes and both leg styles.



TM9428R – TM9429R

STEP-BY-STEP ASSEMBLY

2-PERSON ASSEMBLY RECOMMENDED.

IMPORTANT!

Be sure to keep all parts supported during assembly to avoid damage. Do not over-tighten screws or it will damage the pre-drilled holes; snug fit is adequate.

STEP 1

Lay **Table Top (1)** face down on floor. Note that there are two pre-mounted **Table Leg Clips (4)** for each leg. Each **Table Leg Clip (4)** has three pre-installed **Clip Screws (5)**.

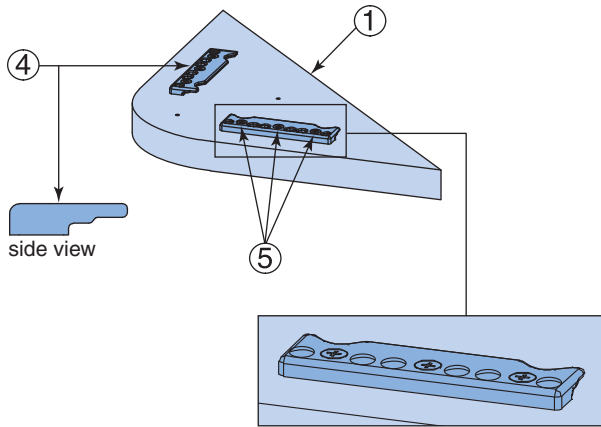

STEP 2

Each adjustable table leg is made up of an **Upper Leg (2)** and **Lower Leg (3)**. **Upper Leg (2)** has a mounting bracket that will be attached to a pair of **Table Leg Clips (4)** and the table top. The set screw is used to secure **Lower Leg (3)** at the desired height. **Lower Leg (3)** has a series of pre-drilled holes for height adjustment, as well as a leveler.

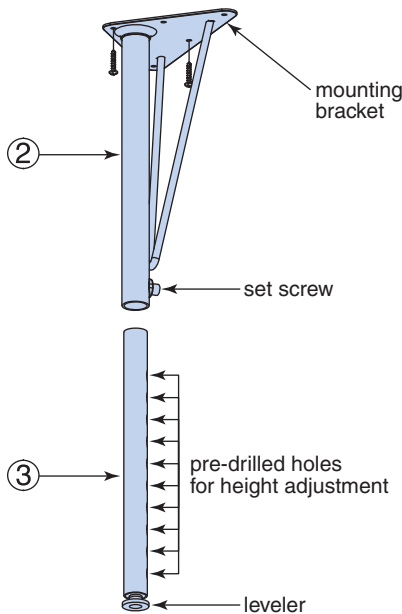

STEP 3

Slide mounting bracket on one **Upper Leg (2)** under lip of both **Table Leg Clips (4)**. The bracket should slide all the way in to the second step. If necessary, loosen the **Clip Screws (5)** to allow the mounting bracket to slide completely into place. When **Upper Leg (2)** is correctly positioned, the two holes in the mounting bracket will align with the pre-drilled holes in the table top, as shown.

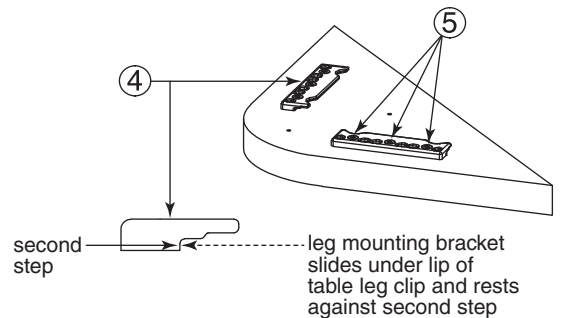
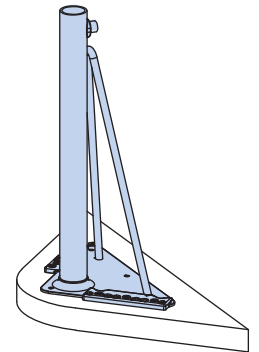
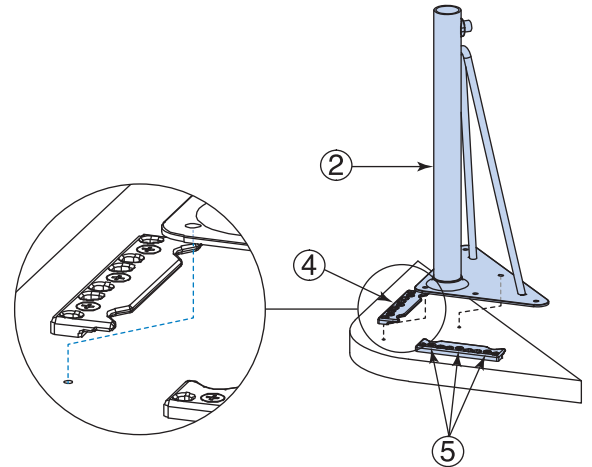



STEP-BY-STEP ASSEMBLY

STEP 4

Tighten the three **Clip Screws (5)** in each **Table Leg Clip (4)**. Secure mounting bracket to table top with two **Leg Screws (6)**.

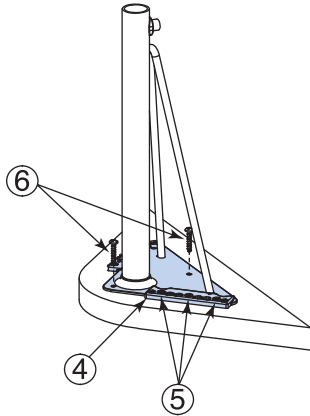

STEP 5

Insert **Lower Leg (3)** into **Upper Leg (2)**. Position **Lower Leg (3)** at desired height, making sure appropriate pre-drilled hole is aligned with the set screw. Tighten set screw.

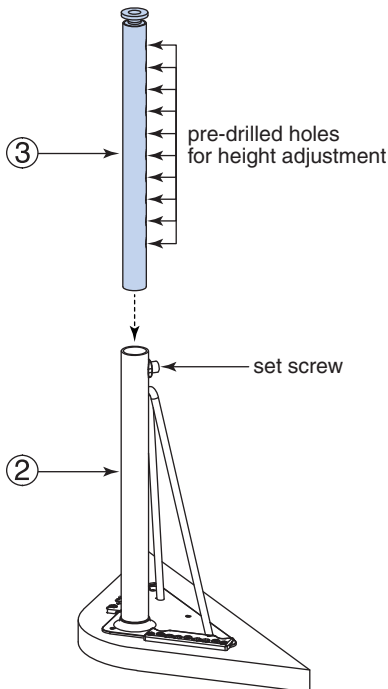

TM9428R:
LEG HEIGHTS range from 13" to 22"
TABLE HEIGHTS range from 14" to 23"

TM9429R:
LEG HEIGHTS range from 20" to 29"
TABLE HEIGHTS range from 21" to 30"

STEP 6

Repeat **Steps 3-5** for remaining legs.

STEP 7

Carefully position table upright and adjust levelers as needed for stable positioning on floor.

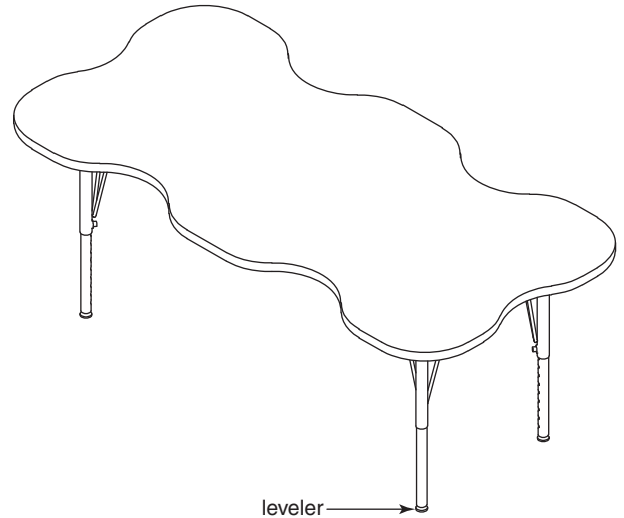

This completes the assembly.