

Dell EMC PowerEdge R750xs

Technical Guide

Notes, cautions, and warnings

 **NOTE:** A NOTE indicates important information that helps you make better use of your product.

 **CAUTION:** A CAUTION indicates either potential damage to hardware or loss of data and tells you how to avoid the problem.

 **WARNING:** A WARNING indicates a potential for property damage, personal injury, or death.

Chapter 1: System overview.....	5
Key workloads.....	5
New technologies.....	5
Chapter 2: System features and generational comparison.....	7
Chapter 3: Chassis views and features.....	10
Chassis views.....	10
Front view of the system.....	10
Rear view of the system.....	11
Inside the system.....	13
Quick Resource Locator.....	17
Chapter 4: Processor.....	18
Processor features	18
Supported processors.....	18
Chapter 5: Memory subsystem.....	20
Supported memory.....	20
Memory speed.....	20
Chapter 6: Storage.....	22
Storage controllers.....	22
Internal storage configuration.....	22
Chapter 7: Networking.....	23
Overview.....	23
OCP 3.0 support.....	23
Supported OCP cards.....	23
OCP NIC 3.0 vs. rack Network Daughter Card comparisons.....	24
Chapter 8: Expansion cards and expansion card risers.....	26
Expansion card installation guidelines.....	26
Chapter 9: Power, thermal, and acoustics.....	35
Power.....	35
Thermal.....	36
Acoustics.....	36
Acoustical performance.....	36
Chapter 10: Rack, rails, and cable management.....	38
Rails information.....	38
Sliding rails.....	38

Static rails.....	40
Cable Management Arm.....	40
Strain Relief Bar	41
Chapter 11: Supported Operating Systems.....	42
Chapter 12: Dell EMC OpenManage systems management.....	43
Server and Chassis Managers.....	44
Dell EMC consoles.....	44
Automation Enablers.....	44
Integration with third-party consoles.....	44
Connections for third-party consoles.....	44
Dell EMC Update Utilities.....	44
Dell resources.....	44
Chapter 13: Dell Technologies Services	46
Dell EMC ProDeploy Enterprise Suite	46
Dell EMC ProDeploy Plus.....	47
Dell EMC ProDeploy.....	47
Basic Deployment.....	47
Dell EMC Server Configuration Services.....	47
Dell EMC Residency Services.....	47
Dell EMC Remote Consulting Services.....	47
Dell EMC Data Migration Service.....	47
Dell EMC ProSupport Enterprise Suite.....	47
Dell EMC ProSupport Plus for Enterprise.....	48
Dell EMC ProSupport for Enterprise.....	48
Dell EMC ProSupport One for Data Center.....	49
ProSupport for HPC.....	49
Support Technologies.....	50
Dell Technologies Education Services.....	51
Dell Technologies Consulting Services.....	51
Dell EMC Managed Services.....	51
Chapter 14: Appendix A: Additional specifications.....	52
Chassis dimensions.....	52
Chassis weight.....	53
Video specifications.....	53
USB ports.....	54
Internal USB.....	54
PSU rating.....	55
Environmental Specifications.....	55
Thermal restrictions.....	55
Chapter 15: Appendix B. Standards compliance.....	56
Chapter 16: Appendix C Additional resources.....	57

System overview

The Dell EMC™ PowerEdge™ R750xs is Dell's latest 2-socket, 1 U rack servers designed to run complex workloads using highly scalable memory, I/O, and network options. The systems feature the 3rd Generation Intel® Xeon Scalable Processor , up to 16 DIMMs, PCI Express® (PCIe) 4 .0 enabled expansion slots, and a choice of network interface technologies to cover NIC.

The PowerEdge R750xs is a general-purpose platform capable of handling demanding workloads and applications, such as data warehouses, ecommerce, databases, and high-performance computing (HPC).

Topics:

- [Key workloads](#)
- [New technologies](#)

Key workloads

The target workloads for the PowerEdge R750xs include virtualization, medium VM density or non-GPU VDI, and scale-out database.

New technologies

Table 1. New technologies

Technology	Detailed Description
3 rd Generation Intel Xeon Scalable Processor	<p>Core count: Up to 32 per processor</p> <p>UPI speed: Up to 3x UPIs/Socket at 10.4 GT/s or 11.2 GT/s</p> <p>Maximum number of PCIe lanes: Integrated 64 PCIe 4.0 lanes @ 16 GT/s PCIe Gen4</p> <p>Maximum TDP: 220 W</p>
3200 MT/s DDR4 Memory	<p>Maximum 8 DIMMs per processor</p> <p>Supports DDR4 ECC RDIMM, with ECC up to 3200 MT/s</p>
Flex IO	<p>LOM board, 2x 1 GB with BCM5720 LAN controller</p> <p>Rear IO with 1 GB Dedicated Management Network Port, USB 3.0 x1, USB 2.0 x1 and VGA port</p> <p>Serial port option</p> <p>OCP Mezz 3.0 (supported by x16 PCIe lanes)</p>
Dedicated PERC	<p>Front storage module PERC with front PERC 10.5 and PERC 11</p>
Power Supplies	<p>60 mm dimension is the new PSU form factor on 15G design</p> <ul style="list-style-type: none"> • 1400 W Platinum AC/100 - 240 V • 1400 W DC/240 V • 1100 W Titanium AC/100 - 240 V • 1100 W DC/240 V

Table 1. New technologies (continued)

Technology	Detailed Description
	<ul style="list-style-type: none">• 1100 W DC/-48-(-60) V• 800 W Platinum AC/100 - 240 V• 800 W DC/240 V• 600 W Platinum AC/100 - 240 V• 600 W DC/240 V

System features and generational comparison

The following table shows the comparison between the PowerEdge R750xs and PowerEdge R740:

Table 2. Feature comparison

Feature	PowerEdge R750xs	PowerEdge R740	
Processor	Maximum two 3 rd Generation Intel® Xeon® Scalable processors with maximum 32 cores per processor	Maximum two 2nd Generation Intel® Xeon® Scalable processors with maximum 28 cores per processor	
Processor Interconnect	Intel Ultra Path Interconnect (UPI)	Intel Ultra Path Interconnect (UPI)	
Memory	16 DDR4 DIMM slots Supports RDIMM 1 TB max Speed maximum 3200 MT/s Supports registered ECC DDR4 DIMMs only Apache Pass : No NVDIMM : No	24 DDR4 DIMM slots Supports RDIMM 1 TB maximum Speed maximum 2933 MT/s Apache Pass : 12x Intel Optane DC Persistent Memory NVDIMM : 12x NVDIMM	
Storage Drives	Front bays: <ul style="list-style-type: none"> 0 drive bay Maximum 8x 3.5-inch SAS/SATA (HDD/SSD) max 128 TB Maximum 12x 3.5-inch SAS/SATA (HDD/SSD) maximum 192 TB Maximum 8x 2.5-inch SAS/SATA/NVMe (HDD/SSD) maximum 61.44 TB Maximum 16x 2.5-inch SAS/SATA (HDD/SSD) maximum 122.88 TB Maximum 16x 2.5-inch (SAS/SATA) + 8x 2.5-inch (NVMe) (HDD/SSD) maximum 184.32 TB 	Front bays: <ul style="list-style-type: none"> Maximum 16x 2.5-inch SAS/SATA/SSD, maximum 122.88 TB Maximum 8x 3.5-inch SAS/SATA, maximum 128 TB 	
	Rear bays: <ul style="list-style-type: none"> Maximum 2x 2.5-inch SAS/SATA/NVMe (HDD/SSD) maximum 15.36 TB 		
Storage Controllers	Internal controllers: PERC H345, PERC H745, PERC H755, PERC H755N, HBA355i	Internal Controllers: PERC H330, H730P, H740P, HBA330	
	Internal Boot: Internal Dual SD Module or Boot Optimized Storage Subsystem (BOSS S2): HWRAID 2x M.2 SSDs or Internal USB		
	External PERC (RAID): PERC H840, HBA355e		External Controllers: H840, 12 Gbps SAS HBA
	Software RAID: S150		Software RAID: S140
PCIe SSD	Maximum 16x 2.5-inch (NVMe drives)	Maximum 12x PCIe SSD (NVMe drives)	

Table 2. Feature comparison (continued)

Feature	PowerEdge R750xs	PowerEdge R740
		Maximum 24x PCIe SSD (NVMe drives)
PCIe Slots	Maximum 5x PCIe Gen4 slots Maximum 1x PCIe Gen3 slots	Maximum 8 x Gen3 slots (4x 16)
Embedded NIC (LOM)	2x 1GbE LOM	Not supported
Networking Options (OCP 3.0)	Maximum 1 OCP 3.0	OCP riser options: <ul style="list-style-type: none"> • 4x 1 GB • 4x 10 GB • 2x 10 GB + 2x 1 GB • 2x 25 GB
USB Ports	Front ports <ul style="list-style-type: none"> • 1x Dedicated iDRAC micro-USB • 1x USB 2.0 • 1x VGA 	Front ports: <ul style="list-style-type: none"> • 1x Dedicated iDRAC direct USB • 2x USB 2.0 • 1x USB 3.0 (optional) • 1x VGA
	Rear ports: <ul style="list-style-type: none"> • 1x USB 2.0 • 1x Serial (optional) • 1x USB 3.0 • 2x Ethernet • 1x VGA 	
	Internal port: <ul style="list-style-type: none"> • 1x USB 3.0 (optional) 	
Rack Height	2U rack server	2U rack server
Power Supplies	<ul style="list-style-type: none"> • 1400 W Platinum AC/100 - 240 V • 1400 W DC/240 V • 1100 W Titanium AC/100 - 240 V • 1100 W DC/240 V • 1100 W DC/-48-(-60) V • 800 W Platinum AC/100 - 240 V • 800 W DC/240 V • 600 W Platinum AC/100 - 240 V • 600 W DC/240 V 	<ul style="list-style-type: none"> • 495 W Platinum • 750 W Platinum • 750 W 240VDC Platinum • 1100 W Platinum • 1100 W -48 V DC Gold • 1100 W 380 V DC Platinum • 1600 W Platinum • 2000 W Platinum • 2400 W Platinum • 750 W Titanium
System Management	<ul style="list-style-type: none"> • Lifecycle Controller 3.x • OpenManage • QuickSync 2.0 • OpenManage Enterprise Power Manager • Digital License Key • iDRAC Direct (dedicated micro-USB port) • Easy Restore 	<ul style="list-style-type: none"> • Lifecycle Controller 3.x • OpenManage • QuickSync 2.0 • OpenManage Enterprise Power Manager • Digital License Key • iDRAC Direct (dedicated micro-USB port) • Easy Restore
Availability	Hot-plug drives Hot-plug redundant cooling Hot-plug redundant power supplies	Hot-plug drives Hot-plug redundant cooling Hot-plug redundant power supplies

Table 2. Feature comparison (continued)

Feature	PowerEdge R750xs	PowerEdge R740
	IDSDM BOSS S2	IDSDM BOSS

Chassis views and features

Topics:

- Chassis views

Chassis views

Front view of the system



Figure 1. Front view of 24 x 2.5-inch drive system



Figure 2. Front view of 16 x 2.5-inch drive system



Figure 3. Front view of 8 x 2.5-inch drive system



Figure 4. Front view of 12 x 3.5-inch drive system



Figure 5. Front view of 8 x 3.5-inch drive system



Figure 6. Front view of 0 drive system

Rear view of the system

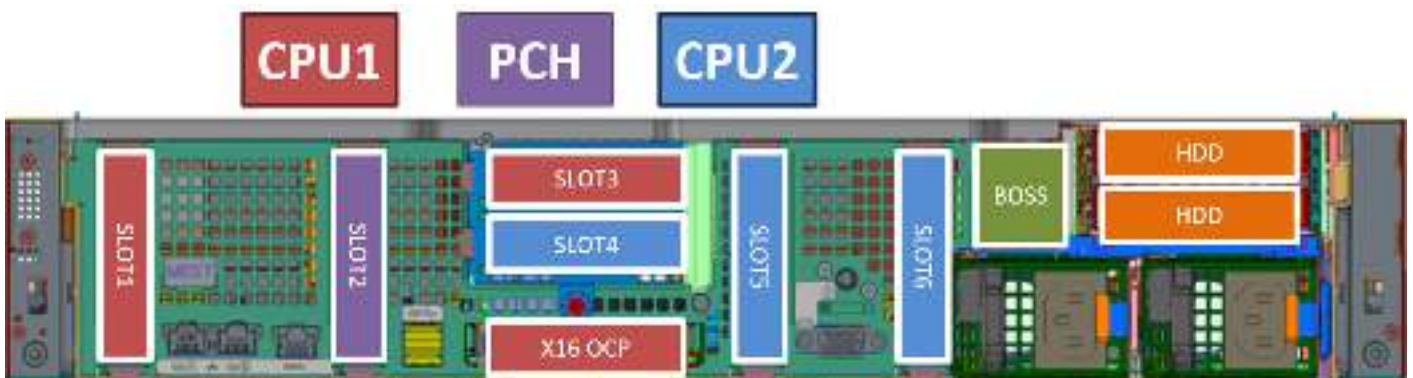

Figure 7. Rear view of the system

Config0. R1a

C0 : 6 x LP

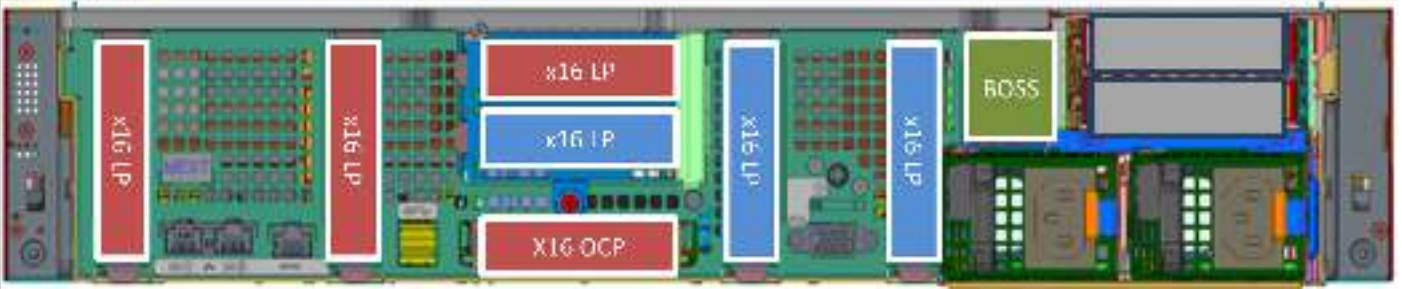

Figure 8. Rear view of the system with riser slot numbering

Config2. R1b

C2 : 6 x LP

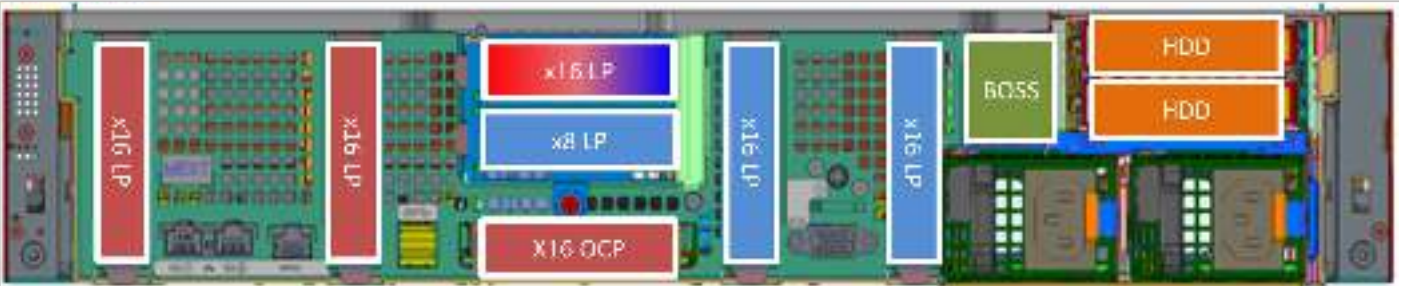

Figure 9. Rear view of the 2x 2.5-inch system with Rear HDD + BOSS

Config3. R1a

C3 : 6 x LP

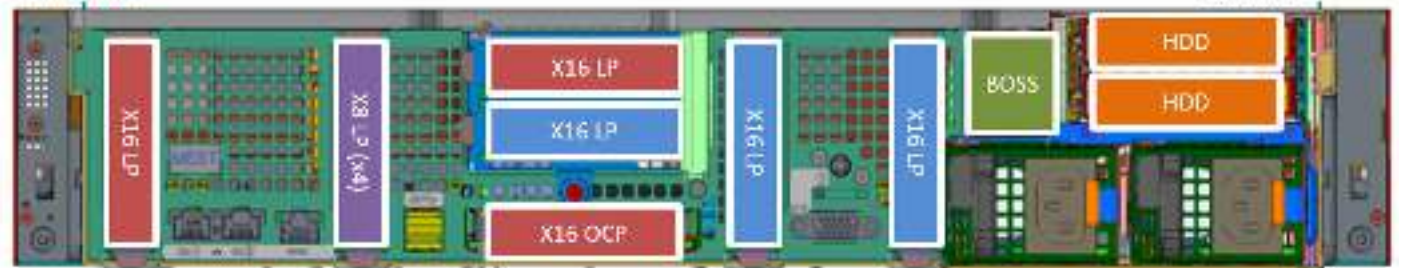

Figure 10. Rear view of the system

Config4. N/A

C4 : 4 x LP

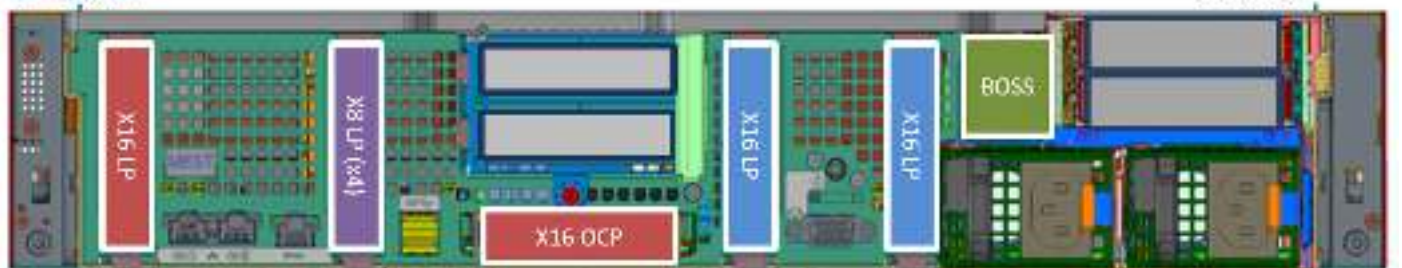

Figure 11. Rear view of the system

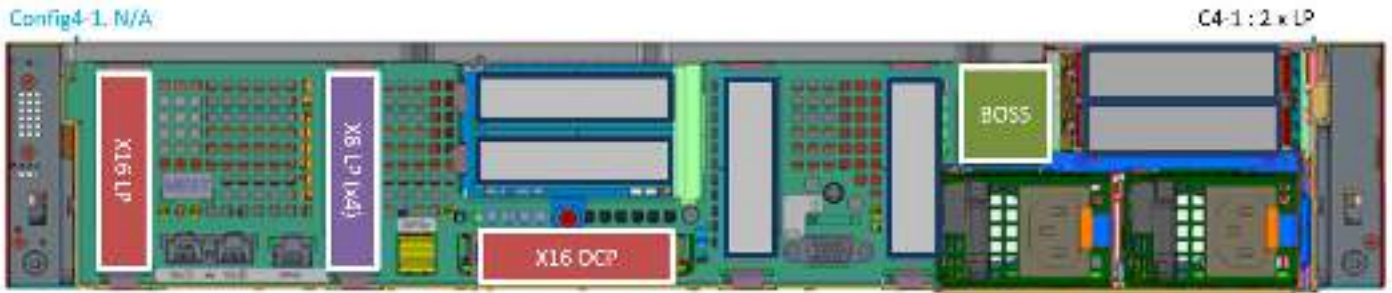

Figure 12. Rear view of the system

Inside the system

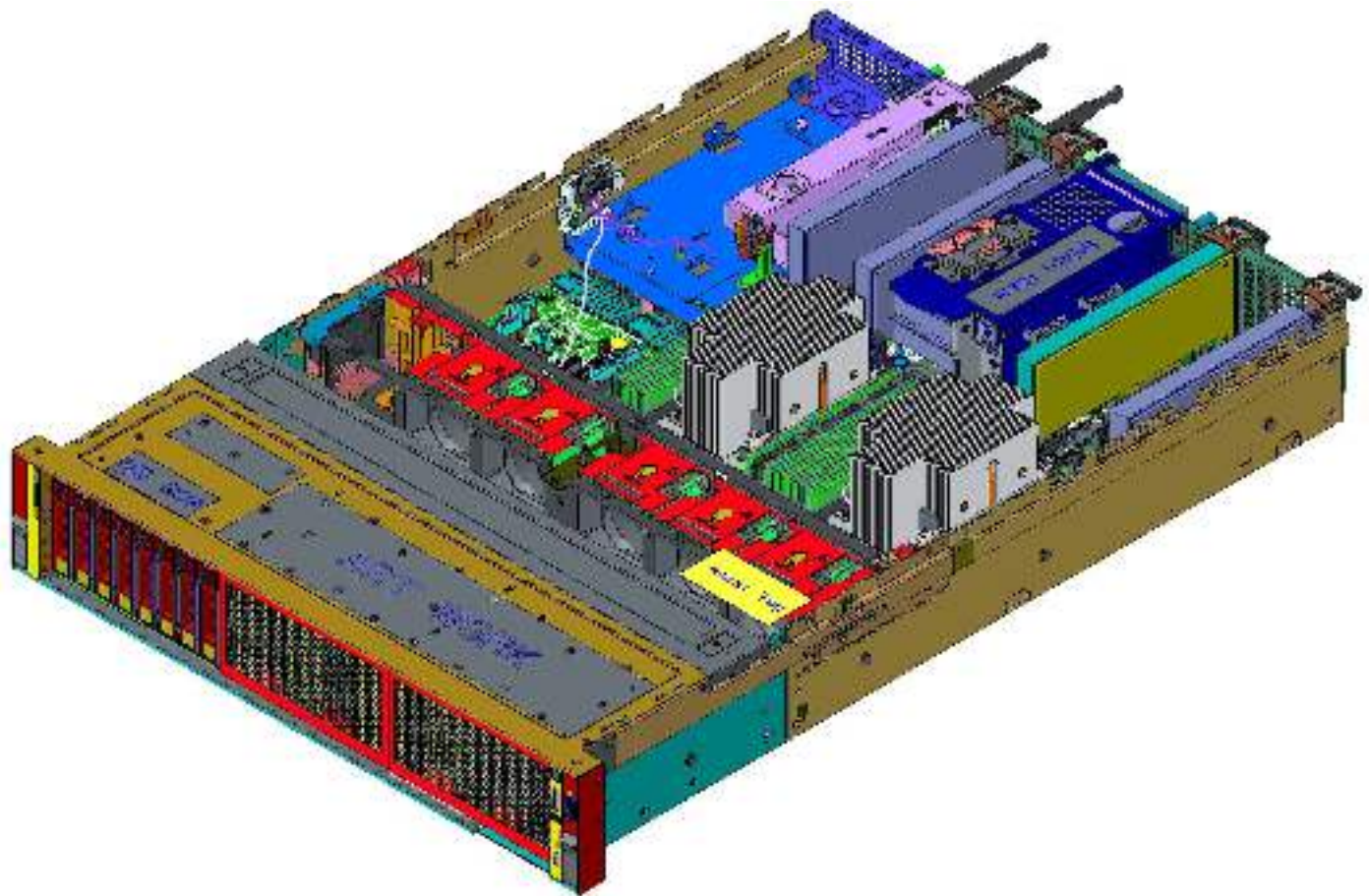

Figure 13. Inside the 8 x 2.5-inch system

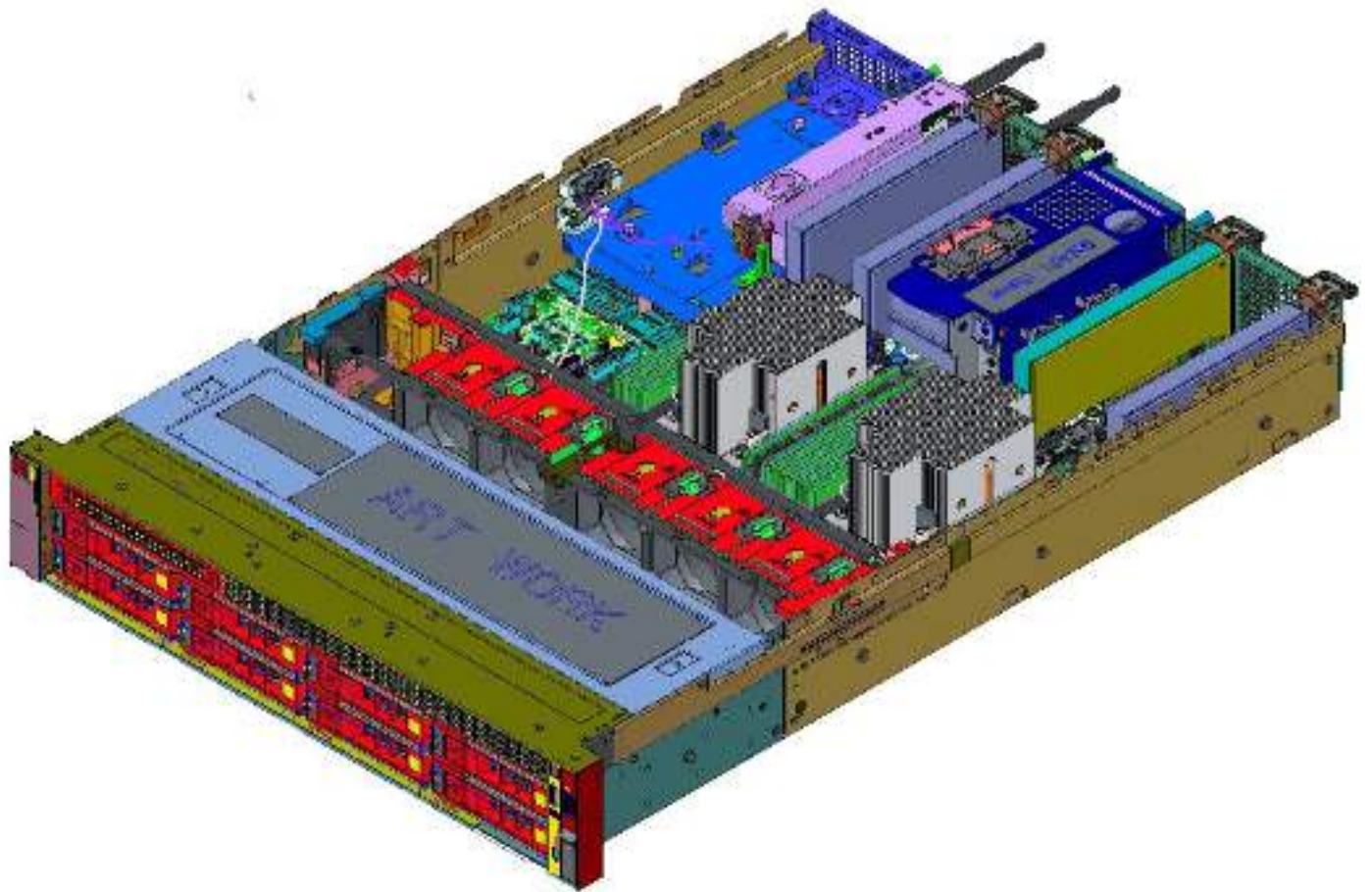

Figure 14. Inside the 8 x 3.5-inch system



Figure 15. Inside the 12 x 3.5-inch system

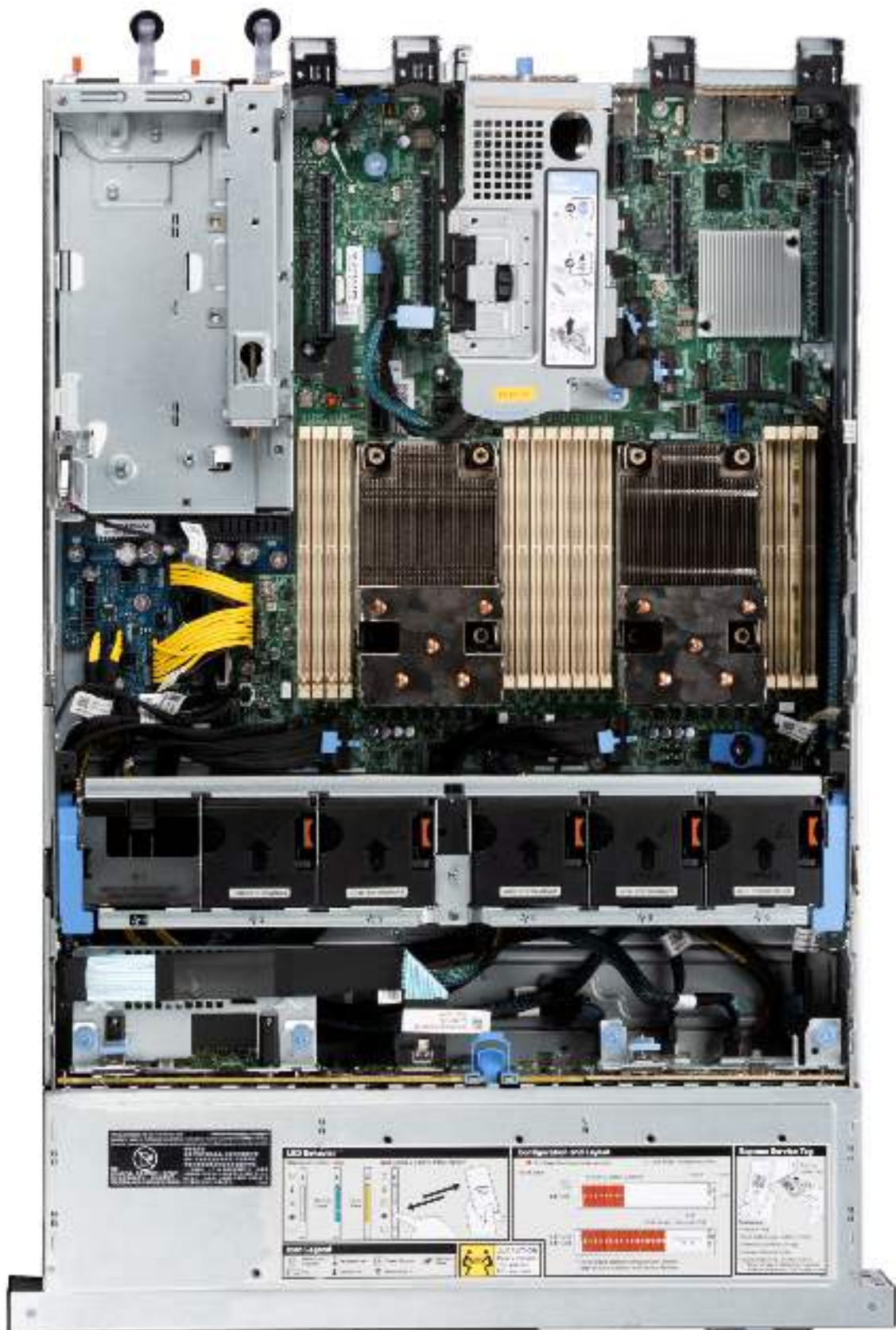

Figure 16. Inside the 16 x 2.5 SAS/SATA + 8 NVMe system

Quick Resource Locator



Figure 17. Quick Resource Locator for R750xs

Processor



Topics:

- Processor features
- Supported processors

Processor features

The 3rd Generation Xeon Scalable Processors stack is the next generation data center processor offering with the latest features, increased performance, and incremental memory options. This latest generation Xeon Scalable processor will support usages from entry designs based on Intel Xeon Silver processors to advanced capabilities offered in new Intel Xeon Platinum processor.

The following lists the features and functions included in the upcoming 3rd Generation Intel Xeon Scalable Processor offering :

- Faster UPI with 3 Intel Ultra Path Interconnect (Intel UPI) at 11.2 GT/s (supported in gold and platinum options)
- More, Faster I/O with PCI Express 4 and up to 64 lanes (per socket) at 16 GT/s
- Enhanced Memory Performance with support for up to 3200 MT/s DIMMs.

Supported processors

Following tables list the various processor SKUs supported.

i | **NOTE:** Mismatched SKUs in a 2S configuration is not allowed.

Table 3. Supported processors for R750xs

Processor	Clock Speed (GHz)	Cache (M)	UPI (GT/s)	Cores	Threads	Turbo	Memory Speed (MT/s)	Memory Capacity	TDP	R750xs
6338	2	36	11	32	64	Turbo	3200	6 TB	205 W	Supported
6338N	2	48	11	32	64	Turbo	2666	6 TB	185 W	Supported
6336Y	2	36	11	24	48	Turbo	3200	6 TB	185 W	Supported
6334	4	18	11	8	16	Turbo	3200	6 TB	165 W	Supported
6330	2	42	11	28	56	Turbo	2933	6 TB	205 W	Supported
6330N	2	42	11	28	56	Turbo	2666	6 TB	165 W	Supported
6326	3	24	11	16	32	Turbo	3200	6 TB	185 W	Supported
6314U	2.3	48	11.2	32	64	Turbo	3200	6 TB	205 W	Supported
6312U	2.4	36	11.2	24	48	Turbo	3200	6 TB	185 W	Supported
5320	2.2	39	11.2	26	52	Turbo	2933	6 TB	185 W	Supported
5320T	2.3	30	11.2	20	40	Turbo	2933	6 TB	150 W	Supported
5318Y	2.1	36	11.2	24	48	Turbo	2933	6 TB	165 W	Supported

Table 3. Supported processors for R750xs (continued)

Processor	Clock Speed (GHz)	Cache (M)	UPI (GT/s)	Cores	Threads	Turbo	Memory Speed (MT/s)	Memory Capacity	TDP	R750xs
5317	3	18	11.2	12	24	Turbo	2933	6 TB	150 W	Supported
5315Y	3.2	12	11.2	8	16	Turbo	2933	6 TB	140 W	Supported
4316	2.3	30	10.4	20	40	Turbo	2666	6 TB	150 W	Supported
4314	2.4	24	10.4	16	32	Turbo	2666	6 TB	135 W	Supported
4310	2.1	18	10.4	12	24	Turbo	2666	6 TB	120 W	Supported
4310T	2.3	15	10.4	10	20	Turbo	2666	6 TB	105 W	Supported
4309Y	2.8	12	10.4	8	16	Turbo	2666	6 TB	105 W	Supported

Memory subsystem

The PowerEdge R750xs supports up to 16 DIMMs, with up to 1024 GB of memory and speeds of up to 3200MT/s.

The PowerEdge R750xs supports registered (RDIMMs) that use a buffer to reduce memory loading and provide greater density, allowing for the maximum platform memory capacity.

Topics:

- [Supported memory](#)
- [Memory speed](#)

Supported memory

The table below lists the memory technologies supported by the platform.

Table 4. Supported memory technologies

Feature	PowerEdge R750xs (DDR4)
DIMM type	RDIMM
Transfer speed	3200 MT/s
Voltage	1.2 V (DDR4)

The following table lists the supported DIMMs for the R750xs at launch. For information on memory configuration, see the *Dell EMC PowerEdge R750xs Installation and Service Manual* at www.dell.com/poweredgemanuals.

Table 5. Supported DIMMs

Capacity	DIMM Type	Config	DRAM	DIMM Max Speed	Rated Voltage
8 GB	RDIMM	1R x8	8 GB	3200 MT/s	1.2 V
16 GB	RDIMM	2R x8	8 GB	3200 MT/s	1.2 V
32 GB	RDIMM	2R x8	16 GB	3200 MT/s	1.2 V
64 GB	RDIMM	2R x4	16 GB	3200 MT/s	1.2 V

Memory speed

The table below lists the memory configuration and performance details for R750xs based on the quantity and type of DIMMs per memory channel.

Table 6. DIMM performance details

DIMM type	Rank	Capacity	DIMM rated voltage and speed	Operating speed for DIMMs per Channel (DPC)
RDIMM	1R	8 GB	DDR4 (1.2V), 3200 MT/s	3200 MT/s

Table 6. DIMM performance details (continued)

DIMM type	Rank	Capacity	DIMM rated voltage and speed	Operating speed for DIMMs per Channel (DPC)
	2R	16 GB, 32 GB, 64 GB	DDR4 (1.2V), 3200 MT/s	3200 MT/s

 **NOTE:** Maximum memory speed supported on the system depends on the processor specifications. So, while the DIMMs supports up to 3200 MT/s, the processor may not support this memory speed. Please refer table Supported processors.

Storage

Topics:

- [Storage controllers](#)
- [Internal storage configuration](#)

Storage controllers

Dell's RAID controller options offer performance improvements, including the fPERC solution. fPERC provides a base RAID HW controller without consuming a PCIe slot by using a small form factor and high-density connector to the base planar.

15G PERC Controller offerings will be a heavy leverage of 14G PERC family. The Value Performance levels will carry over to 15G from 14G. New to 15G, is the Harpoon-based Premium Performance tier offering. This high-end offering will drive IOPs performance and enhanced SSD performance.

Table 7. PERC series controller offerings

Performance Level	Controller & Description
Entry	S150 (SATA, NVMe) SWRAID
Value	H345, HBA355 (Internal/External)
Value Performance	H745, H755, H755N

Internal storage configuration

Please see the [Factory Configuration Matrix](#) on Sales Portal.

Networking

Topics:

- [Overview](#)
- [OCP 3.0 support](#)

Overview

PowerEdge offers a wide variety of options to get information moving to and from our servers. Industry best technologies are chosen, and systems management features are added by our partners to firmware to tie in with iDRAC. These adapters are rigorously validated for worry-free, fully supported use in our servers.

The [PowerEdge Server Adapter Matrix](#) posted to our knowledge portal is the central repository for PowerEdge NIC, HBA and HCA information. The matrix covers:

- Part Numbers, Tied SKUs and Customer Kits
- Server Compatibility & Support
- Optics & Cable Support
- Systems Management
- Adapter Features
- Spec Sheet Links

This document is updated as changes happen, so be sure to bookmark it rather than downloading an offline copy to stay with the latest information.

 **NOTE:** This is a direct download link to an .XLSX and may not open in a tab as expected depending on your browser.

OCP 3.0 support

Supported OCP cards

Table 8. Supported OCP

Form Factor	Vendor	Port type	Port speed	Port count
OCP 3.0	Intel	SFP+	10 GbE	2
OCP 3.0	Broadcom	BT	1 GbE	4
OCP 3.0	Broadcom	BT	10 GbE	2
OCP 3.0	Broadcom	SFP28	25 GbE	2
OCP 3.0	Broadcom	SFP28	25 GbE	4
OCP 3.0	Broadcom	SFP+	10 GbE	2
OCP 3.0	QLogic	BT	10 GbE	2
OCP 3.0	QLogic	SFP+	10 GbE	2
OCP 3.0	QLogic	SFP28	25 GbE	2
OCP 3.0	Intel	BT	1 GbE	4

Table 8. Supported OCP (continued)

Form Factor	Vendor	Port type	Port speed	Port count
OCP 3.0	Intel	BT	10 GbE	2
OCP 3.0	Intel	SFP+	10 GbE	4
OCP 3.0	Intel	SFP28	25 GbE	2
OCP 3.0	Mellanox	SFP28	25 GbE	2
OCP 3.0	SolarFlare	SFP28	25 GbE	2
OCP 3.0	SolarFlare	SFP28	25 GbE	2

OCP NIC 3.0 vs. rack Network Daughter Card comparisons

Table 9. OCP 3.0, 2.0, and rNDC NIC comparison

Form Factor	Dell rNDC	OCP 2.0 (LOM Mezz)	OCP 3.0	Notes
PCIe Gen	Gen 3	Gen 3	Gen 4	Supported OCP3 are SFF (small form factor)
Max PCIe Lanes	x8	Up to x16	Up to x16	See server slot priority matrix
Shared LOM	Yes	Yes	Yes	This is iDRAC port redirect
Aux Power	Yes	Yes	Yes	Used for Shared LOM

OCP form factors

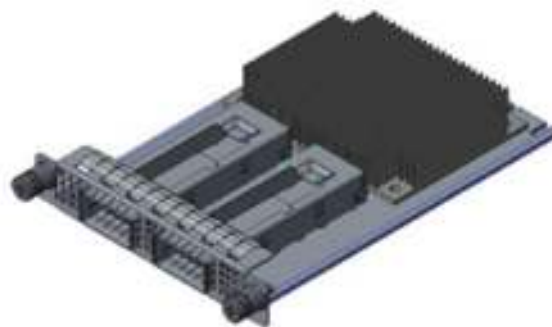

Figure 18. OCP 3.0 small card form factor (LS)

Table 10. OCP 3.0 Feature List

	OCP 3.0
Form factor	SFF and LFF
PCIe Gen	Gen4

Table 10. OCP 3.0 Feature List (continued)

	OCP 3.0
Max PCIe width	X16
Max of ports	4
Port type	BT/SFP/SFP+/SFP28/SFP56
Max port speed	100Gbe
NC-SI	Yes
SNAPI	Yes
WoL	Yes
Power consumption	15 W — 150 W

Expansion cards and expansion card risers

NOTE: A system event entry is logged in the iDRAC Lifecycle Controller if an expansion card riser is not supported or missing. It does not prevent your system from turning on. However, if a F1/F2 pause occurs with an error message, see *Troubleshooting expansion cards* section in the *Dell EMC PowerEdge Servers Troubleshooting Guide* at www.dell.com/poweredgemanuals.

Topics:

- [Expansion card installation guidelines](#)

Expansion card installation guidelines

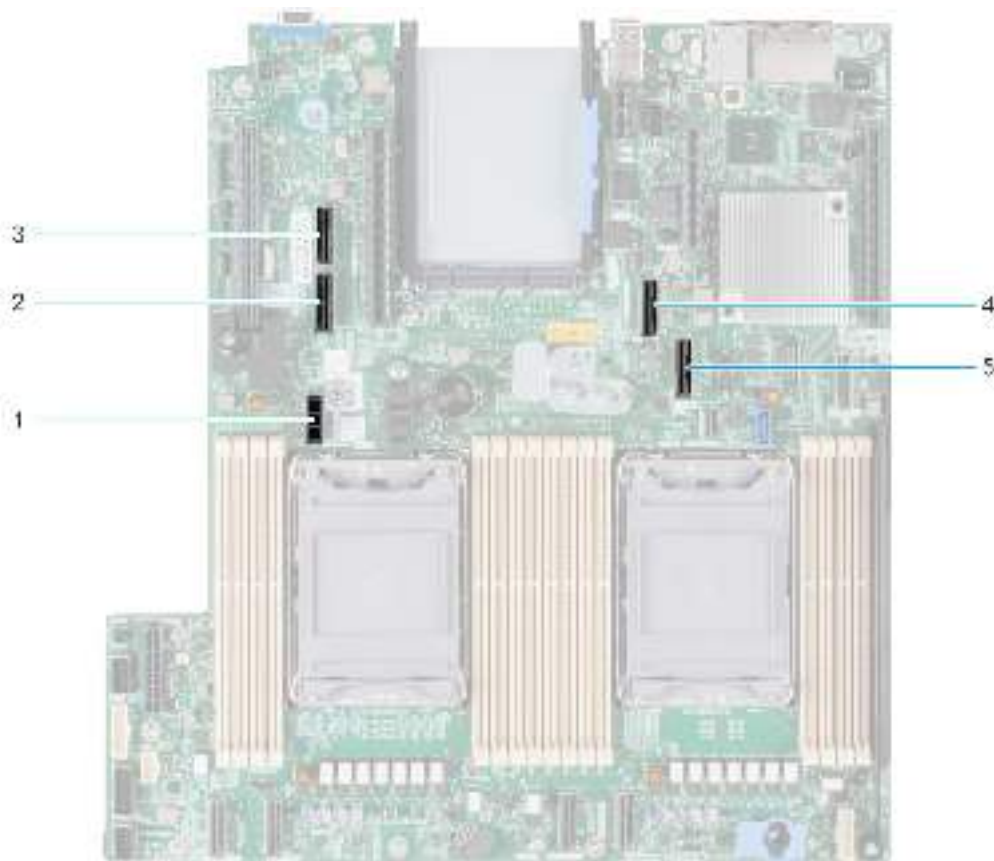

Figure 19. Expansion card slot connectors

1. SIG_PWR_0 (Riser power cable for Riser 1A and Riser 1B)
2. SL6_CPU2_PB3 (PCIe cable connector for Riser 1A and Riser 1B)
3. SL5_CP2_PA1 (PCIe cable connector for Riser 1B)
4. SL7_CPU1_PA4 (PCIe cable connector for Riser 1A and Riser 1B)
5. SL8_CPU1_PB4 (PCIe cable connector for Riser 1A and Riser 1B)

The following table describes the expansion card riser configurations:

Table 11. Expansion card riser configurations

Configurations	Expansion card risers	PCIe Slots	Controlling processor	Height	Length	Slot width	Power
Config0.	R1A	3	Processor 1	Low profile	Half length	x16	75 W
		4	Processor 2	Low profile	Half length	x16	75 W
Config1.	R1B	3	Processor 1 and 2	Low profile	Half length	x16	75 W
		4	Processor 1	Low profile	Half length	x8	75 W
Config2.	R1B	3	Processor 1 and 2	Low profile	Half length	x16	75 W
		4	Processor 1	Low profile	Half length	x8	75 W
Config3.	R1A	3	Processor 1	Low profile	Half length	x16	75 W
		4	Processor 2	Low profile	Half length	x16	75 W
Config4.	NA	NA	NA	NA	NA	NA	NA
		NA	NA	NA	NA	NA	NA
Config5.	NA	NA	NA	NA	NA	NA	NA
		NA	NA	NA	NA	NA	NA

NOTE: Only one cable riser can be installed at a time in any given configuration.

NOTE: R1B is a SNAP1 riser.

NOTE: Config 4 and 5 are no riser configuration.

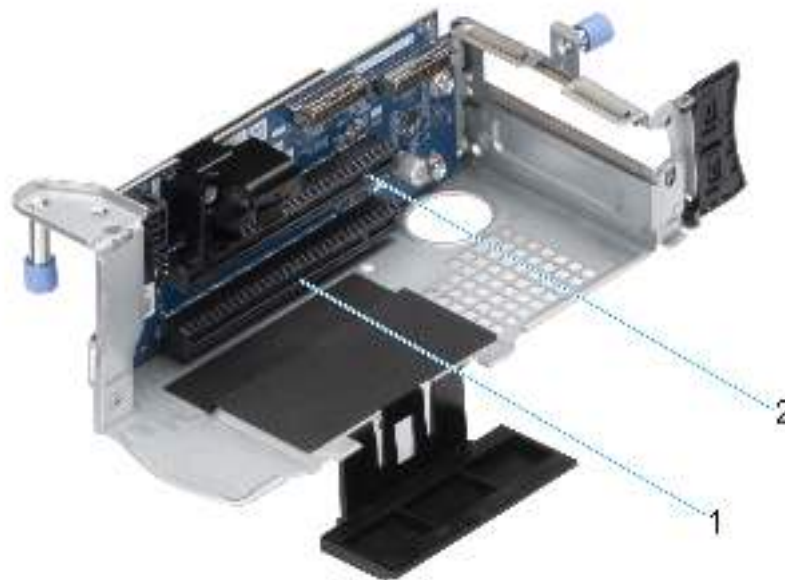

Figure 20. Riser 1A

1. Slot 3
2. Slot 4

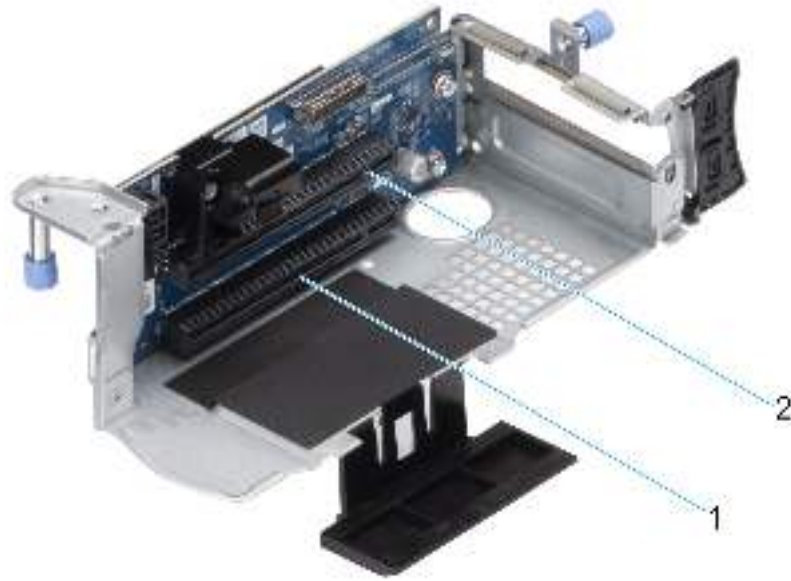

Figure 21. Riser 1B (SNAPI)

1. Slot 3
2. Slot 4

NOTE: The expansion-card slots are not hot-swappable.

The following table provides guidelines for installing expansion cards to ensure proper cooling and mechanical fit. The expansion cards with the highest priority should be installed first using the slot priority indicated. All the other expansion cards should be installed in the card priority and slot priority order.

Table 12. Configuration 0: R1A

Card type	Slot priority	Maximum number of cards
Dell Serial port module (LP)	2	1
fPERC	Integrated slot	1
Internal PERC adapter	1	1
Dell External Adapter	4, 3, 5, 6, 1, 2	6
Mellanox (NIC: 100Gb)	4, 3, 5, 6, 1	5
Broadcom (NIC: 25Gb)	4, 3, 5, 6, 1, 2	6
Intel (NIC: 25Gb)	4, 3, 5, 6, 1, 2	6
Qlogic (NIC: 25Gb)	4, 3, 5, 6, 1, 2	6
Qlogic (NIC: 10Gb)	4, 3, 5, 6, 1, 2	6
SolarFlare (NIC: 25Gb)	4, 3, 5, 6, 1, 2	6
Broadcom (HBA: FC32)	4, 3, 5, 6, 1, 2	6
Marvell (HBA: FC32)	4, 3, 5, 6, 1, 2	6
Avago (HBA: FC16)	4, 3, 5, 6, 1, 2	6
Qlogic (HBA: FC16)	4, 3, 5, 6, 1, 2	6
Broadcom (NIC: 10Gb)	4, 3, 5, 6, 1, 2	6
Intel (NIC: 10Gb)	4, 3, 5, 6, 1, 2	6
Qlogic (NIC: 10Gb)	4, 3, 5, 6, 1, 2	6

Table 12. Configuration 0: R1A (continued)

Card type	Slot priority	Maximum number of cards
Broadcom (NIC: 1Gb)	4, 3, 5, 6, 1, 2	6
Intel (NIC: 1Gb)	4, 3, 5, 6, 1, 2	6
Intel (OCP: 100Gb)	Integrated slot	1
Broadcom (OCP: 25Gb)	Integrated slot	1
Intel (OCP: 25Gb)	Integrated slot	1
Marvell (OCP: 25Gb)	Integrated slot	1
Mellanox (OCP: 25Gb)	Integrated slot	1
SolarFlare (OCP: 25Gb)	Integrated slot	1
Broadcom (OCP: 10Gb)	Integrated slot	1
Marvell (OCP: 10Gb)	Integrated slot	1
Intel (OCP: 10Gb)	Integrated slot	1
Broadcom (OCP: 1Gb)	Integrated slot	1
Intel (OCP: 1Gb)	Integrated slot	1
Dell BOSS S2 Module	Integrated slot	1
Samsung (PCIe SSD AIC)	4, 3, 5, 6, 1, 2	1

Table 13. Configuration 1: R1B

Card type	Slot priority	Maximum number of cards
Dell Serial port module (LP)	2	1
fPERC	Integrated slot	1
Internal PERC adapter	1	1
Mellanox (NIC: 100Gb)	5, 6, 1	3
Intel (NIC: 25Gb)	5, 6, 1, 4, 3, 2	6
Mellanox (NIC: 25Gb)	3	1
Qlogic (NIC: 25Gb)	5, 6, 1, 4, 3, 2	6
SolarFlare (NIC: 25Gb)	5, 6, 1, 4, 3, 2	6
Broadcom (HBA: FC32)	5, 6, 1, 4, 3, 2	3
Marvell (HBA: FC32)	5, 6, 1, 4, 3, 2	6
Avago (HBA: FC16)	5, 6, 1, 4, 3, 2	3
QLogic (HBA: FC16)	5, 6, 1, 4, 3, 2	6
Broadcom (NIC: 10Gb)	5, 6, 1, 4, 3, 2	6
Broadcom (NIC: 25Gb)	5, 6, 1, 4, 3, 2	6
Intel (NIC: 10Gb)	5, 6, 1, 4, 3, 2	6
Qlogic (NIC: 10Gb)	5, 6, 1, 4, 3, 2	6
Broadcom (NIC: 1Gb)	5, 6, 1, 4, 3, 2	6
Intel (NIC: 1Gb)	5, 6, 1, 4, 3, 2	6
Mellanox (NIC: HDR100 VPI)	3	1
Intel (OCP: 100Gb)	Integrated slot	1

Table 13. Configuration 1: R1B (continued)

Card type	Slot priority	Maximum number of cards
Broadcom (OCP: 25Gb)	Integrated slot	1
Intel (OCP: 25Gb)	Integrated slot	1
Marvell (OCP: 25Gb)	Integrated slot	1
Mellanox (OCP: 25Gb)	Integrated slot	1
SolarFlare (OCP: 25Gb)	Integrated slot	1
Broadcom (OCP: 10Gb)	Integrated slot	1
Marvell (OCP: 10Gb)	Integrated slot	1
Intel (OCP: 10Gb)	Integrated slot	1
Broadcom (OCP: 1Gb)	Integrated slot	1
Intel (OCP: 1Gb)	Integrated slot	1
Dell External PERC Adapter	5, 6, 1, 4, 3, 2	6
Dell BOSS S2 Module	Integrated slot	1
Samsung (PCIe SSD AIC)	5, 6, 1, 4, 3, 2	6

Table 14. Configuration 2: R1B

Card type	Slot priority	Maximum number of cards
Dell Serial port module (LP)	2	1
Internal PERC adapter	1	1
12Gbps SAS HBA	1	1
Intel (NIC: 100Gb)	4, 3, 5, 6, 1	5
Mellanox (NIC: 100Gb)	5, 6, 1	3
Intel (NIC: 25Gb)	5, 6, 1, 4, 3, 2	6
Mellanox (NIC: 25Gb)	3	1
Qlogic (NIC: 25Gb)	5, 6, 1, 4, 3, 2	6
Broadcom (NIC: 10Gb)	5, 6, 1, 4, 3, 2	6
Broadcom (NIC: 25Gb)	5, 6, 1, 4, 3, 2	6
SolarFlare (NIC: 25Gb)	5, 6, 1, 4, 3, 2	6
Broadcom (HBA: FC32)	5, 6, 1, 4, 3, 2	6
Marvell (HBA: FC32)	5, 6, 1, 4, 3, 2	6
Avago (HBA: FC16)	5, 6, 1, 4, 3, 2	6
QLogic (HBA: FC16)	5, 6, 1, 4, 3, 2	6
Intel (NIC: 10Gb)	5, 6, 1, 4, 3, 2	6
Qlogic (NIC: 10Gb)	5, 6, 1, 4, 3, 2	6
Intel (NIC: 1Gb)	5, 6, 1, 4, 3, 2	6
Mellanox (NIC: HDR100 VPI)	3	1
Broadcom (OCP: 25Gb)	Integrated slot	1
Intel (OCP: 25Gb)	Integrated slot	1
Marvell (OCP: 25Gb)	Integrated slot	1

Table 14. Configuration 2: R1B (continued)

Card type	Slot priority	Maximum number of cards
Mellanox (OCP: 25Gb)	Integrated slot	1
SolarFlare (OCP: 25Gb)	Integrated slot	1
Broadcom (OCP: 10Gb)	Integrated slot	1
Marvell (OCP: 10Gb)	Integrated slot	1
Intel (OCP: 10Gb)	Integrated slot	1
Broadcom (OCP: 1Gb)	Integrated slot	1
Intel (OCP: 1Gb)	Integrated slot	1
Dell External PERC Adapter	1	1
Dell BOSS S2 Module	Integrated slot	1
Samsung (PCIe SSD AIC)	5, 6, 1, 4, 3, 2	6

Table 15. Configuration 3: R1A

Card type	Slot priority	Maximum number of cards
Dell Serial port module (LP)	2	1
Intel (NIC: 100Gb)	4, 3, 5, 6, 1	5
Mellanox (NIC: 100Gb)	4, 3, 5, 6, 1	5
Broadcom (NIC: 25Gb)	4, 3, 5, 6, 1, 2	6
Intel (NIC: 25Gb)	4, 3, 5, 6, 1, 2	6
Mellanox (NIC: 25Gb)	3	1
Qlogic (NIC: 25Gb)	4, 3, 5, 6, 1, 2	6
SolarFlare (NIC: 25Gb)	4, 3, 5, 6, 1, 2	6
Broadcom (HBA: FC32)	4, 3, 5, 6, 1, 2	6
Marvell (HBA: FC32)	4, 3, 5, 6, 1, 2	6
Avago (HBA: FC16)	4, 3, 5, 6, 1, 2	6
QLogic (HBA: FC16)	4, 3, 5, 6, 1, 2	6
Broadcom (NIC: 10Gb)	4, 3, 5, 6, 1, 2	6
Intel (NIC: 10Gb)	4, 3, 5, 6, 1, 2	6
Qlogic (NIC: 10Gb)	4, 3, 5, 6, 1, 2	6
Broadcom (NIC: 1Gb)	4, 3, 5, 6, 1, 2	6
Intel (NIC: 1Gb)	4, 3, 5, 6, 1, 2	6
Mellanox (NIC: HDR100 VPI)	3	1
Broadcom (OCP: 25Gb)	Integrated slot	1
Intel (OCP: 25Gb)	Integrated slot	1
Marvell (OCP: 25Gb)	Integrated slot	1
Mellanox (OCP: 25Gb)	Integrated slot	1
SolarFlare (OCP: 25Gb)	Integrated slot	1
Broadcom (OCP: 10Gb)	Integrated slot	1
Marvell (OCP: 10Gb)	Integrated slot	1

Table 15. Configuration 3: R1A (continued)

Card type	Slot priority	Maximum number of cards
Intel (OCP: 10Gb)	Integrated slot	1
Broadcom (OCP: 1Gb)	Integrated slot	1
Intel (OCP: 1Gb)	Integrated slot	1
Dell External PERC Adapter	4, 3, 5, 6, 1, 2	6
Dell BOSS S2 Module	Integrated slot	1
Samsung (PCIe SSD AIC)	4, 3, 5, 6, 1, 2	2

Table 16. Configuration 4: No riser

Card type	Slot priority	Maximum number of cards
Dell Serial port module (LP)	1	1
fPERC	Integrated slot	1
Internal PERC adapter	1	1
12Gbps SAS HBA	1	1
Intel (NIC: 100Gb)	5, 6, 1	3
Mellanox (NIC: 100Gb)	5, 6, 1	3
Broadcom (NIC: 25Gb)	5, 6, 1, 2	1
Intel (NIC: 25Gb)	5, 6, 1, 2	1
Mellanox (NIC: 25Gb)	Not supported	N/a
Qlogic (NIC: 25Gb)	5, 6, 1, 2	1
SolarFlare (NIC: 25Gb)	5, 6, 1, 2	4
Broadcom (HBA: FC32)	5, 6, 1, 2	4
Marvell (HBA: FC32)	5, 6, 1, 2	4
Avago (HBA: FC16)	5, 6, 1, 2	4
QLogic (HBA: FC16)	5, 6, 1, 2	4
Broadcom (NIC: 10Gb)	5, 6, 1, 2	4
Intel (NIC: 10Gb)	5, 6, 1, 2	4
Qlogic (NIC: 10Gb)	5, 6, 1, 2	4
Broadcom (NIC: 1Gb)	5, 6, 1, 2	4
Intel (NIC: 1Gb)	5, 6, 1, 2	4
Mellanox (NIC: HDR100 VPI)	Not supported	N/a
Mellanox (NIC: HDR VPI)	Not supported	N/a
Broadcom (OCP: 25Gb)	Integrated slot	1
Intel (OCP: 25Gb)	Integrated slot	1
Marvell (OCP: 25Gb)	Integrated slot	1
Mellanox (OCP: 25Gb)	Integrated slot	1
SolarFlare (OCP: 25Gb)	Integrated slot	1
Broadcom (OCP: 10Gb)	Integrated slot	1
Marvell (OCP: 10Gb)	Integrated slot	1

Table 16. Configuration 4: No riser (continued)

Card type	Slot priority	Maximum number of cards
Intel (OCP: 10Gb)	Integrated slot	1
Broadcom (OCP: 1Gb)	Integrated slot	1
Intel (OCP: 1Gb)	Integrated slot	1
Dell External PERC Adapter	5, 6, 1, 2	4
Dell BOSS S1 Module	Integrated slot	1
Samsung (PCIe SSD AIC)	5, 6, 1, 2	4
Intel (PCIe SSD)	Not supported	N/a

Table 17. Configuration 5: No Riser

Card type	Slot priority	Maximum number of cards
Dell Serial port module (LP)	1	1
fPERC	Integrated slot	1
Internal PERC adapter	1	1
12Gbps SAS HBA	1	1
Intel (NIC: 100Gb)	1	1
Mellanox (NIC: 100Gb)	1	1
Broadcom (NIC: 25Gb)	1, 2	1
Intel (NIC: 25Gb)	1, 2	1
Mellanox (NIC: 25Gb)	Not supported	N/a
Qlogic (NIC: 25Gb)	1, 2	1
SolarFlare (NIC: 25Gb)	1, 2	4
Broadcom (HBA: FC32)	1, 2	4
Marvell (HBA: FC32)	1, 2	4
Avago (HBA: FC16)	1, 2	4
QLogic (HBA: FC16)	1, 2	4
Broadcom (NIC: 10Gb)	1, 2	4
Intel (NIC: 10Gb)	1, 2	4
Qlogic (NIC: 10Gb)	1, 2	4
Broadcom (NIC: 1Gb)	1, 2	4
Intel (NIC: 1Gb)	1, 2	4
Mellanox (NIC: HDR100 VPI)	Not supported	N/a
Mellanox (NIC: HDR VPI)	Not supported	N/a
Broadcom (OCP: 25Gb)	Integrated slot	1
Intel (OCP: 25Gb)	Integrated slot	1
Marvell (OCP: 25Gb)	Integrated slot	1
Mellanox (OCP: 25Gb)	Integrated slot	1
SolarFlare (OCP: 25Gb)	Integrated slot	1
Broadcom (OCP: 10Gb)	Integrated slot	1

Table 17. Configuration 5: No Riser (continued)

Card type	Slot priority	Maximum number of cards
Marvell (OCP: 10Gb)	Integrated slot	1
Intel (OCP: 10Gb)	Integrated slot	1
Broadcom (OCP: 1Gb)	Integrated slot	1
Intel (OCP: 1Gb)	Integrated slot	1
Dell External PERC Adapter	1, 2	4
Dell BOSS S1 Module	Integrated slot	1
Samsung (PCIe SSD AIC)	1, 2	4
Intel (PCIe SSD)	Not supported	N/a

Power, thermal, and acoustics

PowerEdge servers have an extensive collection of sensors that automatically track thermal activity, which helps regulate temperature thereby reducing server noise and power consumption. The table below lists the tools and technologies Dell offers to lower power consumption and increase energy efficiency.

Topics:

- [Power](#)
- [Thermal](#)
- [Acoustics](#)

Power

Table 18. Power tools and technologies

Feature	Description
Power Supply Units(PSU) portfolio	Dell's PSU portfolio includes intelligent features such as dynamically optimizing efficiency while maintaining availability and redundancy. Find additional information in the Power supply units section.
Tools for right sizing	[Include EIPT description.]
Industry Compliance	Dell's servers are compliant with all relevant industry certifications and guide lines, including 80 PLUS, Climate Savers and ENERGY STAR.
Power monitoring accuracy	PSU power monitoring improvements include: <ul style="list-style-type: none"> • Dell's power monitoring accuracy is currently 1%, whereas the industry standard is 5%. • More accurate reporting of power. • Better performance under a power cap.
Power capping	Use Dell's systems management to set the power cap limit for your systems to limit the output of a PSU and reduce system power consumption. Dell is the first hardware vendor to leverage Intel Node Manager for circuit-breaker fast capping.
Systems Management	iDRAC Enterprise and Datacenter provides server- level management that monitors, reports and controls power consumption at the processor, memory and system level. Dell OpenManage Power Center delivers group power management at the rack, row and data center level for servers, power distribution units and uninterruptible power supplies.
Active power management	—
Fresh Air cooling	Refer to ASHRAE A3/A4 Thermal Restriction.
Rack infrastructure	Dell offers some of the industry's highest-efficiency power infrastructure solutions, including <ul style="list-style-type: none"> • Power distribution units (PDUs). • Uninterruptible power supplies (UPSs).

Table 18. Power tools and technologies (continued)

Feature	Description
	<ul style="list-style-type: none"> • Energy Smart containment rack enclosures. • Find additional information at: http://content.dell.com/us/en/enterprise/power-and-cooling-technologies-components-rack-infrastructure.aspx.

Thermal

PowerEdge servers have an extensive collection of sensors that automatically track thermal activity, which helps regulate temperature thereby reducing server noise and power consumption.

Acoustics

Acoustical performance

Dell EMC PowerEdge R750xs are rack-mount server whose acoustical out ranges from that appropriate for an office to that of data centers.

Acoustical performance is provided in terms of the following configurations:

- R750xs Software Defined Storage (with rear storage) - Category 5
- R750xs Entry - Category 2

Acoustical configuration details are provided in the tables below.

Table 19. Acoustical configurations of R750xs

Configuration	R750xs Software Defined Storage (with rear storage)	R750xs Entry
Processor Type	3rd Generation Intel Xeon Scalable Processor	3rd Generation Intel Xeon Scalable Processor
Processor TDP	150 W	105 W
Processor Quantity	2	1
RDIMM Memory	16 GB, DDR4	8 GB, DDR4
Memory Quantity	8	1
Backplane Type	Front 12x 3.5-inch BP + rear 2x 2.5-inch BP	8x 3.5-inch BP
HDD Type	SATA 3.5-inch 7.2K + rear 2.5-inch NVME	SATA 3.5-inch 7.2K
HDD Quantity	12+2	2
Flash Drives	NA	NA
Flash Quantity	NA	NA
PSU Type	1400 W	800 W
PSU Quantity	2	1
OCP	2x10G	4 x1G
PCI 1	Adapt H345	NA

Table 19. Acoustical configurations of R750xs (continued)

Configuration	R750xs Software Defined Storage (with rear storage)	R750xs Entry
PCI 2	NA	NA
PCI 3	NA	NA
PCI 4	NA	NA
PCI 5	BROADCOM Dual port NIC Card (25G)	NA
PCI 6	NA	NA
M.2 BOSS	BOSS 1.5(OS)	NA
PERC	NA	Front H345

Table 20. Acoustical performance of R750xs acoustical configurations

Configuration	R750xs Software Defined Storage (with rear storage)	R750xs Entry	
Acoustical Performance: Idle/ Operating @ 23°C Ambient			
L_{wA,m} (B)	Idle	6.7	4.7
	Operating	6.7	4.7
K_v (B)	Idle	0.4	0.4
	Operating	0.4	0.4
L_{pA,m} (dB)	Idle	52	33
	Operating	52	34
Prominent tones	No prominent tones in Idle and Operating		
Acoustical Performance: Idle @ 28°C Ambient			
L_{wA,m} (B)	7.2	5.2	
K_v (B)	0.4	0.4	
L_{pA,m} (dB)	57	35	
Acoustical Performance: Max. Loading @ 35°C Ambient			
L_{wA,m} (B)	7.6	5.6	
K_v (B)	0.4	0.4	
L_{pA,m} (dB)	62	40	

Each configuration has been tested according to Dell EMC acoustical standards for rack-mounted servers.

Rack, rails, and cable management

Key factors in selecting the proper rails include, Identifying:

- Type of rack in which the rails will be installed
- Spacing between the front and rear mounting flanges of the rack
- Type and location of any equipment mounted on the rear of the rack such as power distribution units (PDUs), and the overall depth of the rack

Reference the [DellEMC Enterprise Systems Rail Sizing and Rack Compatibility Matrix](#) for the following information:

- Specific details about rail types and their functionalities
- Rail adjustability ranges for various rack mounting flange types
- Rail depth with and without cable management accessories
- Rack types supported for various rack mounting flange types

Topics:

- [Rails information](#)
- [Cable Management Arm](#)
- [Strain Relief Bar](#)

Rails information

The R750xs supports both sliding rails and static rails. Both rails have a slim rail design that supports the wide system chassis.

Sliding rails

The sliding rails, shown in the figure below, allow the system to be fully extended out of the rack for service. The sliding rails have a Cable Management Arm (CMA) and a Strain Relief Bar (SRB) option.

There are two types of sliding rails available:

- Ready Rails II sliding rails
- Stab-in/Drop-in sliding rails

B21 Ready Rails II sliding rails for 4-post racks

- Supports Drop-in installation of the chassis to the rails
- Supports tool-less installation in 19-inch EIA-310-E compliant square or unthreaded round hole 4-post racks including all generations of Dell racks
- Supports tooled installation in 19-inch EIA-310-E compliant threaded hole 4-post racks
- Supports full extension of the system out of the rack to allow serviceability of key internal components
- Supports optional Cable Management Arm (CMA)
- Supports optional Strain Relief Bar (SRB)

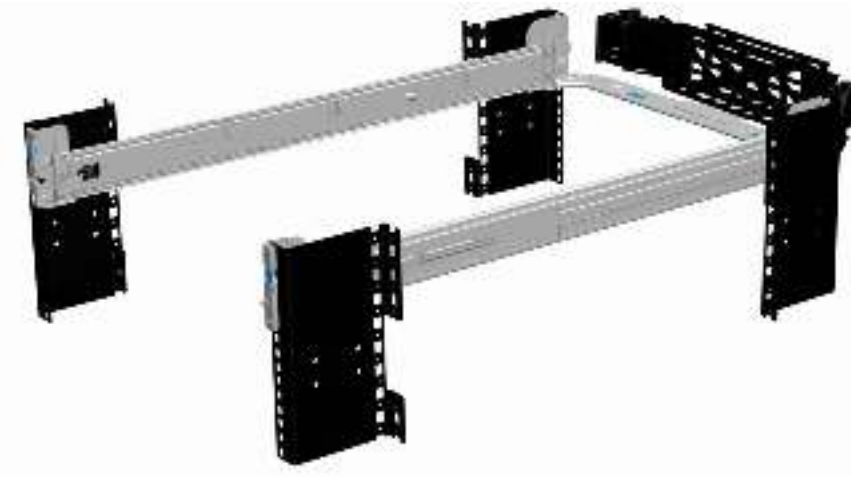

Figure 22. Sliding rails with optional CMA



Figure 23. Sliding rails with optional SRB

B22 Stab-in/Drop-in sliding rails for 4-post racks

- Supports Drop-in or Stab-in installation of the chassis to the rails
- Supports tool-less installation in 19-inch EIA-310-E compliant square, unthreaded round hole racks including all generations of Dell racks.

Also supports tool-less installation in threaded round hole 4-post racks

- Supports full extension of the system out of the rack to allow serviceability of key internal components
- Supports optional Cable Management Arm (CMA)

i NOTE: For situations where CMA support is not required, the outer CMA mounting brackets can be uninstalled from the sliding rails. This reduces the overall length of the rails and eliminates the potential interferences with rear mounted PDUs or the rear rack door.

- Supports optional Strain Relief Bar (SRB)

i NOTE: Scan the QRL code for the documentation and troubleshooting information regarding the installation procedures for Drop-in/Stab-in rail types.

Static rails

The static rails, shown in the figure below, support a wider variety of racks than the sliding rails, but do not support serviceability in the rack. The static rails are not compatible with the CMA and SRB.

B20 Ready Rails static rails for 4-post and 2-post racks

- Supports Stab-in installation of the chassis to the rails
- Supports tool-less installation in 19-inch EIA-310-E compliant square or unthreaded round hole 4-post racks including all generations of Dell racks
- Supports tooled installation in 19-inch EIA-310-E compliant threaded hole 4-post and 2-post racks
- Supports tooled installation in Dell EMC Titan or Titan-D rack

NOTE:

- Screws are not included with the static rail kit since racks are offered with various thread types. The screws are provided for mounting static rails in racks with threaded mounting flanges.
- Screw head diameter should be 10mm or less.



Figure 24. Static rails

Cable Management Arm

The optional Cable Management Arm (CMA) for the system organizes and secures the cords and cables exiting the back of the server and unfolds to allow the server to extend out of the rack without having to detach the cables.

Some key features of the CMA include:

- Large U-shaped baskets to support dense cable loads.
- Open vent pattern for optimal airflow.
- Support for mounting on either side by swinging the spring-loaded brackets from one side to the other.
- Utilizes hook-and-loop straps rather than plastic tie wraps to eliminate the risk of cable damage during cycling.
- Includes a low-profile fixed tray to both support and retain the CMA in its fully closed position.
- Both the CMA and the tray mount without the use of tools through simple and intuitive snap-in designs.

The CMA can be mounted to either side of the sliding rails without the use of tools or the need for conversion. For systems with one power supply unit (PSU), it is recommended to mount on the side opposite to that of the power supply to allow easier access to it and the rear drives (if applicable) for service or replacement.

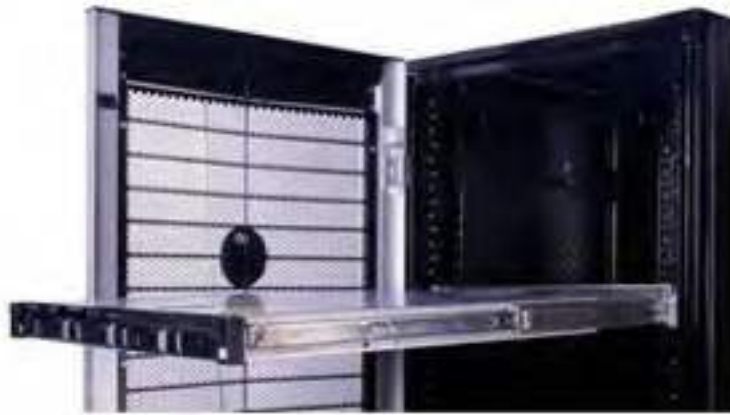

Strain Relief Bar

The optional Strain Relief Bar (SRB) for the system organizes and secures cables exiting the back of the server.

Sliding rails with optional SRB:

- Supports tool-less attachment to rails
- Supports Two depth positions to accommodate various cable loads and rack depths
- Supports cable loads and controls stresses on server connectors
- Cables can be segregated into discrete, purpose-specific bundles

Supported Operating Systems

The PowerEdge R750xs system supports the following operating systems:

- Canonical® Ubuntu® Server LTS
- Citrix® Hypervisor®
- Microsoft® Windows Server® with Hyper-V
- Red Hat® Enterprise Linux
- SUSE® Linux Enterprise server
- VMware® ESXi®

Links to specific OS versions and editions, certification matrices, Hardware Compatibility Lists (HCL) portal, and Hypervisor support are available at [Dell EMC Enterprise Operating Systems](#).

Dell EMC OpenManage systems management

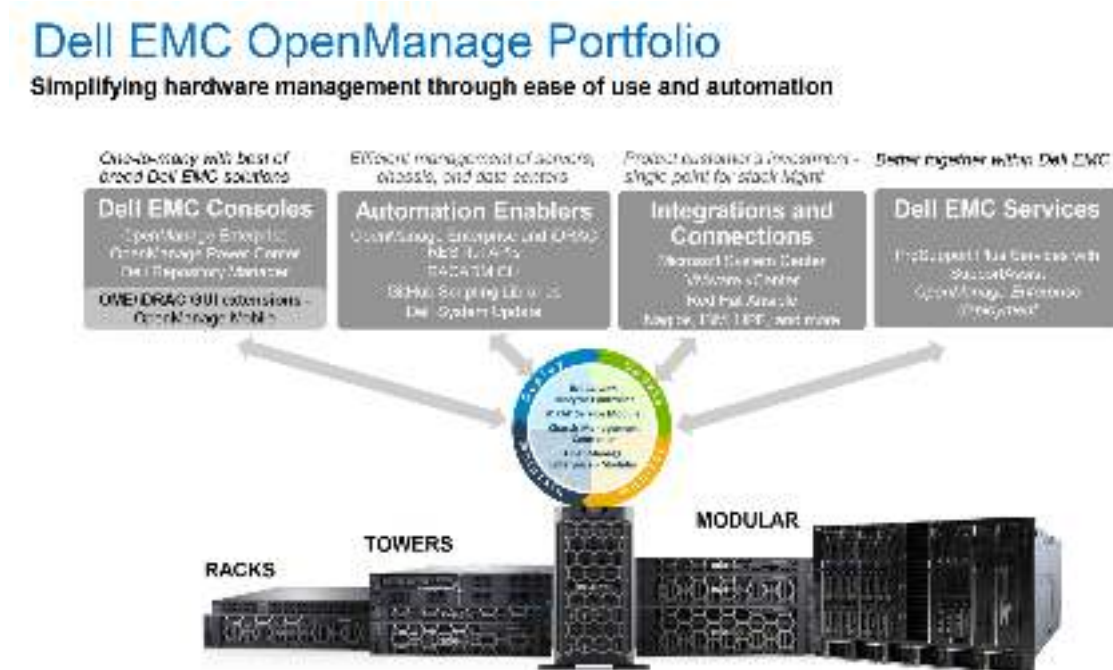

Figure 25. Dell EMC OpenManage Portfolio

Dell EMC delivers management solutions that help IT Administrators effectively deploy, update, monitor, and manage IT assets. OpenManage solutions and tools enable you to quickly respond to problems by helping them to manage Dell EMC servers effectively and efficiently; in physical, virtual, local, and remote environments, operating in-band, and out-of-band (agent-free). The OpenManage portfolio includes innovative embedded management tools such as the integrated Dell Remote Access Controller (iDRAC), Chassis Management Controller and Consoles like OpenManage Enterprise, OpenManage Power Manager plug in, and tools like Repository Manager.

Dell EMC has developed comprehensive systems management solutions based on open standards and has integrated with management consoles that can perform advanced management of Dell hardware. Dell EMC has connected or integrated the advanced management capabilities of Dell hardware into offerings from the industry's top systems management vendors and frameworks such as Ansible, thus making Dell EMC platforms easy to deploy, update, monitor, and manage.

The key tools for managing Dell EMC PowerEdge servers are iDRAC and the one-to-many OpenManage Enterprise console. OpenManage Enterprise helps the system administrators in complete lifecycle management of multiple generations of PowerEdge servers. Other tools such as Repository Manager, which enables simple yet comprehensive change management.

OpenManage tools integrate with systems management framework from other vendors such as VMware, Microsoft, Ansible, and ServiceNow. This enables you to use the skills of the IT staff to efficiently manage Dell EMC PowerEdge servers.

Topics:

- [Server and Chassis Managers](#)
- [Dell EMC consoles](#)
- [Automation Enablers](#)
- [Integration with third-party consoles](#)
- [Connections for third-party consoles](#)
- [Dell EMC Update Utilities](#)
- [Dell resources](#)

Server and Chassis Managers

- Integrated Dell Remote Access Controller (iDRAC)
- iDRAC Service Module (iSM)

Dell EMC consoles

- Dell EMC OpenManage Enterprise
- Dell EMC Repository Manager (DRM)
- Dell EMC OpenManage Enterprise Power Manager plugin to OpenManage Enterprise
- Dell EMC OpenManage Mobile (OMM)

Automation Enablers

- OpenManage Ansible Modules
- iDRAC RESTful APIs (Redfish)
- Standards-based APIs (Python, PowerShell)
- RACADM Command Line Interface (CLI)
- GitHub Scripting Libraries

Integration with third-party consoles

- Dell EMC OpenManage Integrations with Microsoft System Center
- Dell EMC OpenManage Integration for VMware vCenter (OMIVV)
- Dell EMC OpenManage Ansible Modules
- Dell EMC OpenManage Integration with ServiceNow

Connections for third-party consoles

- Micro Focus and other HPE tools
- OpenManage Connection for IBM Tivoli
- OpenManage Plug-in for Nagios Core and XI

Dell EMC Update Utilities

- Dell System Update (DSU)
- Dell EMC Repository Manager (DRM)
- Dell EMC Update Packages (DUP)
- Dell EMC Server Update Utility (SUU)
- Dell EMC Platform Specific Bootable ISO (PSBI)

Dell resources

For additional information about white papers, videos, blogs, forums, technical material, tools, usage examples, and other information, go to the OpenManage page at <https://www.dell.com/openmanagemanuals> or the following product pages:

Table 21. Dell resources

Resource	Location
Integrated Dell Remote Access Controller (iDRAC)	https://www.dell.com/idracmanuals
iDRAC Service Module (iSM)	https://www.dell.com/support/kbdoc/000178050/
OpenManage Ansible Modules	https://www.dell.com/support/kbdoc/000177308/
OpenManage Essentials (OME)	https://www.dell.com/support/kbdoc/000175879/
OpenManage Mobile (OMM)	https://www.dell.com/support/kbdoc/000176046
OpenManage Integration for VMware vCenter (OMIVV)	https://www.dell.com/support/kbdoc/000176981/
OpenManage Integration for Microsoft System Center (OMIMSSC)	https://www.dell.com/support/kbdoc/000147399
Dell EMC Repository Manager (DRM)	https://www.dell.com/support/kbdoc/000177083
Dell EMC System Update (DSU)	https://www.dell.com/support/kbdoc/000130590
Dell EMC Platform Specific Bootable ISO (PSBI)	Dell.com/support/article/sln296511
Dell EMC Chassis Management Controller (CMC)	www.dell.com/support/article/sln311283
OpenManage Connections for Partner Consoles	https://www.dell.com/support/kbdoc/000146912
OpenManage Enterprise Power Manager	https://www.dell.com/support/kbdoc/000176254
OpenManage Integration with ServiceNow (OMISNOW)	Dell.com/support/article/sln317784

 **NOTE:** Features may vary by server. Please refer to the product page on <https://www.dell.com/manuals> for details.

Dell Technologies Services

Dell Technologies Services include a wide, customizable range of service choices to simplify the assessment, design, implementation, management and maintenance of IT environments and to help you transition from platform to platform. Depending on your current business requirements and the level of service right for you, we provide factory, on-site, remote, modular, and specialized services that fit your needs and budget. We'll help with a little or a lot—your choice—and provide access to our global resources.

For more information, see DellEMC.com/Services.

Topics:

- [Dell EMC ProDeploy Enterprise Suite](#)
- [Dell EMC Remote Consulting Services](#)
- [Dell EMC Data Migration Service](#)
- [Dell EMC ProSupport Enterprise Suite](#)
- [Dell EMC ProSupport Plus for Enterprise](#)
- [Dell EMC ProSupport for Enterprise](#)
- [Dell EMC ProSupport One for Data Center](#)
- [ProSupport for HPC](#)
- [Support Technologies](#)
- [Dell Technologies Education Services](#)
- [Dell Technologies Consulting Services](#)
- [Dell EMC Managed Services](#)

Dell EMC ProDeploy Enterprise Suite

ProDeploy Enterprise Suite gets your server out of the box and into optimized production—fast. Our elite deployment engineers with broad and deep experience utilizing best-in-class processes along with our established global scale can help you around the clock and around the globe. From simple to the most complex server installations and software integration, we take the guess work and risk out of deploying your new server technology.

		Basic Deployment	ProDeploy	ProDeploy Plus
Pre-deployment	Single point of contact for project management	-	●	In-region
	Site readiness review	-	●	■
	Implementation planning	-	●	●
	SAM engagement for ProSupport Plus entitled devices	-	-	●
Deployment	Deployment service hours	Business hours	24x7	24x7
	Remote guidance for hardware installation or	Onsite	Remote or Onsite	Onsite
	Onsite hardware installation and packaging material removal	-	Remote	Onsite
	Install and configure system software	-	●	●
	Install support software and connect with Dell Technologies	-	●	●
Post-deployment	Project documentation with knowledge transfer	-	●	●
	Deployment verification	-	●	●
	Configuration data transfer to Dell EMC technical support	-	●	■
	30-days of post-deployment configuration assistance	-	-	●
	Training credits for Dell EMC Education Services	-	-	●

Figure 26. ProDeploy Enterprise Suite capabilities

 **NOTE:** Hardware installation not applicable on selected software products.

Dell EMC ProDeploy Plus

From beginning to end, ProDeploy Plus provides the skill and scale needed to successfully execute demanding deployments in today's complex IT environments. Certified Dell EMC experts start with extensive environmental assessments and detailed migration planning and recommendations. Software installation includes set up of most versions of Dell EMC SupportAssist and OpenManage system management utilities. Post-deployment configuration assistance, testing, and product orientation services are also available.

Dell EMC ProDeploy

ProDeploy provides full service installation and configuration of both server hardware and system software by certified deployment engineers including set up of leading operating systems and hypervisors as well as most versions of Dell EMC SupportAssist and OpenManage system management utilities. To prepare for the deployment, we conduct a site readiness review and implementation planning exercise. System testing, validation, and full project documentation with knowledge transfer complete the process.

Basic Deployment

Basic Deployment delivers worry-free professional installation by experienced technicians who know Dell EMC servers inside and out.

Dell EMC Server Configuration Services

With Dell EMC Rack Integration and other Dell EMC PowerEdge Server Configuration Services, you save time by receiving your systems racked, cabled, tested, and ready to integrate into the data center. Dell EMC staff pre-configure RAID, BIOS and iDRAC settings, install system images, and even install third-party hardware and software.

For more information, see [Server Configuration Services](#).

Dell EMC Residency Services

Residency Services helps customers transition to new capabilities quickly with the assistance of on-site or remote Dell EMC experts whose priorities and time you control. Residency experts can provide post implementation management and knowledge transfer related to a new technology acquisition or day-to-day operational management of the IT infrastructure.

Dell EMC Remote Consulting Services

When you are in the final stages of your PowerEdge server implementation, you can rely on Dell EMC Remote Consulting Services and our certified technical experts to help you optimize your configuration with best practices for your software, virtualization, server, storage, networking, and systems management.

Dell EMC Data Migration Service

Protect your business and data with our single point of contact to manage your data migration project. Your project manager will work with our experienced team of experts to create a plan using industry-leading tools and proven processes based on global best practices to migrate your existing files and data so your business system get up and running quickly and smoothly.

Dell EMC ProSupport Enterprise Suite

With the ProSupport Enterprise Suite, we help keep your IT systems running smoothly, so you can focus on running your business. We will help maintain peak performance and availability of your most essential workloads. ProSupport Enterprise Suite is a suite of support services that enable you to build the solution that is right for your organization.

Choose support models based on how you use technology and where you want to allocate resources. From the desktop to the data center, address everyday IT challenges, such as unplanned downtime, mission-critical needs, data and asset protection, support planning, resource allocation, software application management and more. Optimize IT resources by choosing the right support model.



Figure 27. Dell EMC ProSupport Enterprise Suite

Dell EMC ProSupport Plus for Enterprise

When you purchase your PowerEdge server, we recommend ProSupport Plus, our proactive and preventative support service for your business-critical systems. ProSupport Plus provides you with all the benefits of ProSupport, plus the following:

- An assigned Services Account Manager who knows your business and your environment
- Immediate advanced troubleshooting from an engineer who understands your PowerEdge server
- Personalized, preventive recommendations based on analysis of support trends and best practices from across the Dell Technologies infrastructure solutions customer base to reduce support issues and improve performance
- Predictive analysis for issue prevention and optimization enabled by SupportAssist
- Proactive monitoring, issue detection, notification, and automated case creation for accelerated issue resolution enabled by SupportAssist
- On-demand reporting and analytics-based recommendations enabled by SupportAssist and TechDirect

Dell EMC ProSupport for Enterprise

Our ProSupport service offers highly trained experts around the clock and around the globe to address your IT needs. We help minimize disruptions and maximize availability of PowerEdge server workloads with:

- 24x7 support through phone, chat and online
- Predictive, automated tools and innovative technology
- A central point of accountability for all hardware and software issues
- Collaborative 3rd party support
- Hypervisor, operating system and application support
- Consistent experience regardless of where you are located or what language you speak
- Optional onsite parts and labor response options including next business day or four-hour mission critical

i **NOTE:** Subject to service offer country availability.

Enterprise Support Services Feature Comparison

	Basic	ProSupport	ProSupport Plus
Remote technical support	9x5	24x7	24x7
Covered products	Hardware	Hardware Software	Hardware Software
Onsite hardware support	Next business day	Next business day or 4 hr mission critical	Next business day or 4 hr mission critical
3 rd party collaborative assistance		●	●
Automated issue detection & proactive case creation		●	●
Self-service case initiation and management		●	●
Access to software updates		●	●
Priority access to specialized support experts			●
3 rd party software support			●
Assigned Services Account Manager			●
Personalized assessments and recommendations			●
Semiannual systems maintenance			●

Availability and terms of Dell Technologies services may vary by region and by product. For more information, please view our Service Description page at www.dell.com.

Figure 28. Dell EMC Enterprise Support model

Dell EMC ProSupport One for Data Center

ProSupport One for Data Center offers flexible site-wide support for large and distributed data centers with more than 1,000 assets. This offering is built on standard ProSupport components that leverage our global scale but are tailored to your company's needs. While not for everyone, this service option offers a truly unique solution for Dell Technologies largest customers with the most complex environments.

- Team of assigned Services Account Managers with remote, on-site options
- Assigned ProSupport One technical and field engineers who are trained on your environment and configurations
- On-demand reporting and analytics-based recommendations enabled by SupportAssist and TechDirect
- Flexible on-site support and parts options that fit your operational model
- A tailored support plan and training for your operations staff

ProSupport for HPC

The ProSupport for HPC provides solution-aware support including:

- Access to senior HPC experts
- Advanced HPC cluster assistance: performance, interoperability & configuration
- Enhanced HPC solution level end-to-end support
- Remote pre-support engagement with HPC Specialists during ProDeploy implementation

Learn more at DellEMC.com/HPC-Services.

ProSupport Add-on for HPC

Delivering a true end-to-end support experience across your HPC environment

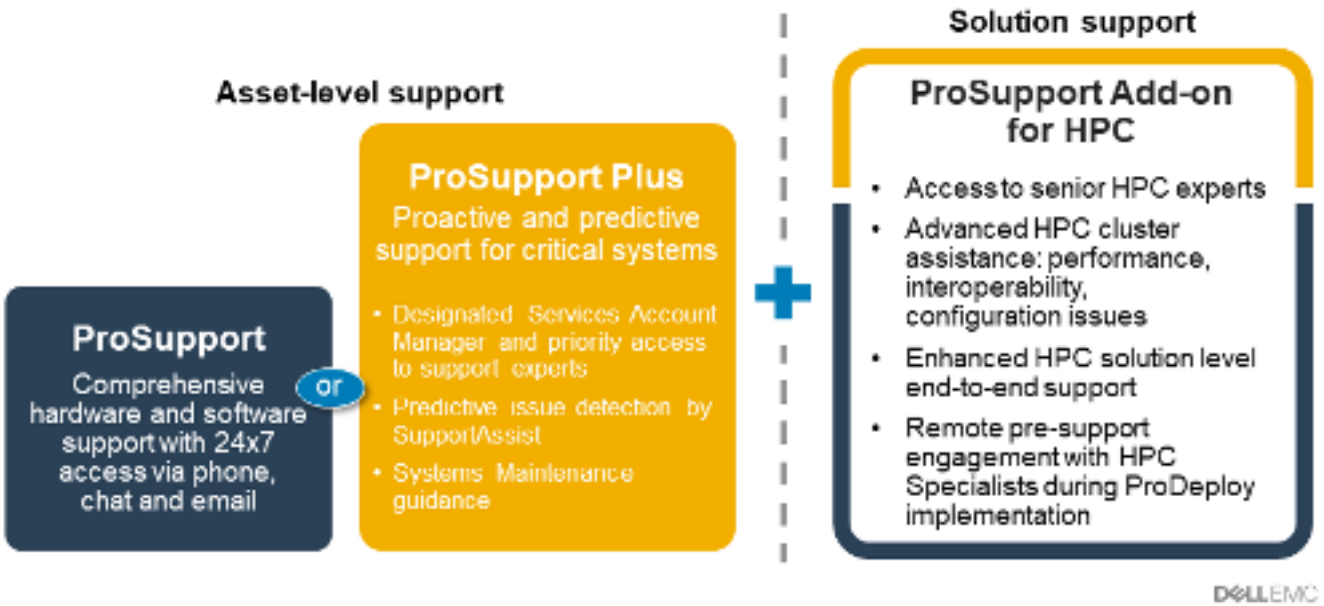

Figure 29. ProSupport for HPC

Support Technologies

Powering your support experience with predictive, data-driven technologies.

Dell EMC SupportAssist

The best time to solve a problem is before it happens. The automated proactive and predictive technology SupportAssist helps reduce steps and time to resolution, often detecting issues before they become a crisis. Benefits include:

- Value—SupportAssist is available to all customers at no additional charge
- Improve productivity—replace manual, high-effort routines with automated support
- Accelerate time to resolution—receive issue alerts, automatic case creation, and proactive contact from Dell EMC experts
- Gain insight and control—optimize enterprise devices with on-demand ProSupport Plus reporting in TechDirect, and get predictive issue detection before the problem starts

NOTE: SupportAssist is included with all support plans, but features vary based on service level agreement.

	Basic Hardware Warranty	ProSupport	ProSupport Plus
Automated issue detection and system state information collection	•	•	•
Proactive, automated case creation and notification		•	•
Predictive issue detection for failure prevention			•
Recommendation reporting available on-demand in TechDirect			•

Figure 30. SupportAssist model

Get started at Dell.com/SupportAssist

Dell EMC TechDirect

Boost IT team productivity when supporting Dell EMC systems. With over 1.4 million self-dispatches processed each year, TechDirect has proven its effectiveness as a support tool. You can:

- Self-dispatch replacement parts
- Request technical support
- Integrate APIs into your help desk

Or, access all your Dell EMC certification and authorization requirements. Train your staff on Dell EMC products, as TechDirect allows you to:

- Download study guides
- Schedule certification and authorization exams
- View transcripts of completed courses and exams

Register at techdirect.dell.

Dell Technologies Education Services

Build the IT skills required to influence the transformational outcomes of the business. Enable talent and empower teams with the right skills to lead and execute transformational strategy that drives competitive advantage. Leverage the training and certification required for real transformation.

Dell Technologies Education Services offers PowerEdge server training and certifications designed to help you achieve more from your hardware investment. The curriculum delivers the information and the practical, hands-on skills that you and your team need to confidently install, configure, manage, and troubleshoot your Dell EMC servers. To learn more or register for a class today, see LearnDell.com/Server.

Dell Technologies Consulting Services

Our expert consultants help you transform faster, and quickly achieve business outcomes for the high value workloads Dell EMC PowerEdge systems can handle.

From strategy to full-scale implementation, Dell Technologies Consulting can help you determine how to execute your IT, workforce, or application transformation.

We use prescriptive approaches and proven methodologies combined with Dell Technologies' portfolio and partner ecosystem to help you achieve real business outcomes. From multi-cloud, applications, DevOps, and infrastructure transformations, to business resiliency, data center modernization, analytics, workforce collaboration, and user experiences—we're here to help.

Dell EMC Managed Services

Reduce the cost, complexity, and risk of managing IT. Focus your resources on digital innovation and transformation while our experts help optimize your IT operations and investment with managed services backed by guaranteed service levels.

Appendix A: Additional specifications

Topics:

- Chassis dimensions
- Chassis weight
- Video specifications
- USB ports
- PSU rating
- Environmental Specifications

Chassis dimensions

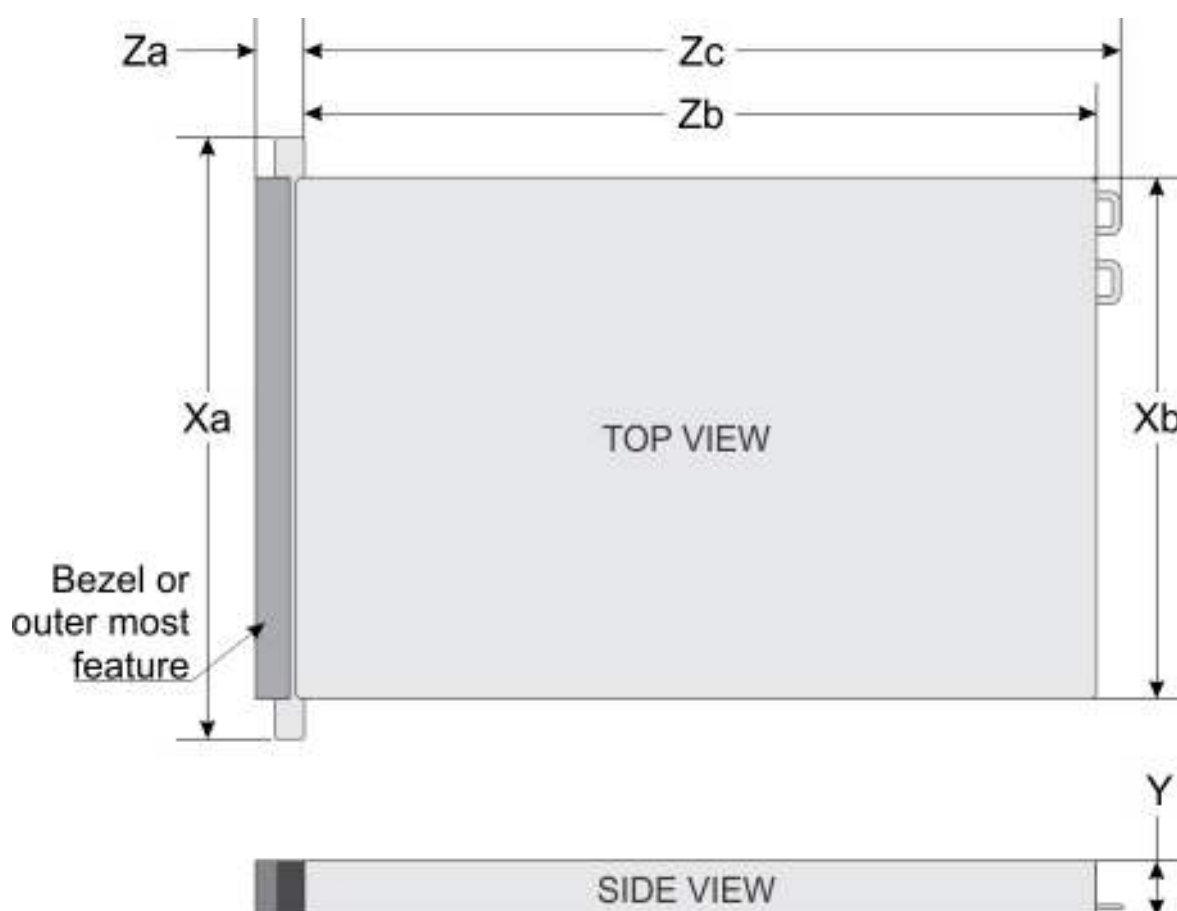

Figure 31. PowerEdge R750xs chassis dimensions

Table 22. Chassis dimensions

Drives	Xa	Xb	Y	Za	Zb	Zc
24 drives (16 + 8)	482.0 mm	434.0 mm	86.8 mm (3.41 inches)	22.0 mm (0.86 inches) Without bezel	675.04 mm (26.57 inches) Ear to L bracket housing	685.78 mm (26.99 inches)
16 drives						

Table 22. Chassis dimensions (continued)

Drives	Xa	Xb	Y	Za	Zb	Zc
12 drives	(18.97 inches)	(17.08 inches)		35.84 mm (1.41 inches)	650.24 mm (25.6 inches)	Ear to PSU handle without velcro strap
8 drives				With bezel		
No backplane configuration						

Chassis weight

Table 23. PowerEdge R750xs system weight

System configuration	Maximum weight (with all drives/SSDs/rails/bezel)
24 (16 SAS/SATA + 8 NVMe) x 2.5-inch	23.84 kg (52.55 lb)
8x 2.5-inch	20.44 kg (45.06 lb)
12x 3.5-inch	28.76 kg (63.40 lb)
16x 2.5-inch	21.94 kg (48.36 lb)
8x 3.5-inch	24.80 kg (54.67 lb)
No backplane configuration	18.54 kg (40.87 lb)

Video specifications

The platform supports the following video resolution and refresh rates:

Table 24. Video Resolution and Refresh Rate

Resolution	Refresh rate (Hz)	Color depth (bits)
1024 x 768	60	8, 16, 32
1280 x 800	60	8, 16, 32
1280 x 1024	60	8, 16, 32
1360 x 768	60	8, 16, 32
1440 x 900	60	8, 16, 32
1600 x 900	60	8, 16, 32
1600 x 1200	60	8, 16, 32
1680 x 1050	60	8, 16, 32
1920 x 1080	60	8, 16, 32
1920 x 1200	60	8, 16, 32

*DVO - DP is for investigation only, dependent on Nuvoton DVO capabilities to support up to 165 MHz. Rear Panel Performance is TBD subject to final board design and losses to rear VGA connector

*(RB) - Reduced Blanking for Digital Displays requiring less blank time. This was introduced for Signal Integrity improvements by reducing Pixel Clock rates for VGA- Analog input devices.

USB ports

All USB ports follow USB specifications.

USB 2.0 and USB 3.0 ports support maximum output current of 0.5 A and 0.9 A, respectively.

The ports cannot support high power consumption devices such as CD-ROM on the rear USB port of the rear I/O board and on the right control panel USB 2.0 port.



Figure 32. Front USB 2.0 port



Figure 33. Rear USB 3.0 port (bottom) and USB 2.0 port (top)

Internal USB

The size of the internal USB card dongle is 40 x 16 x 8 mm (L x W x H).

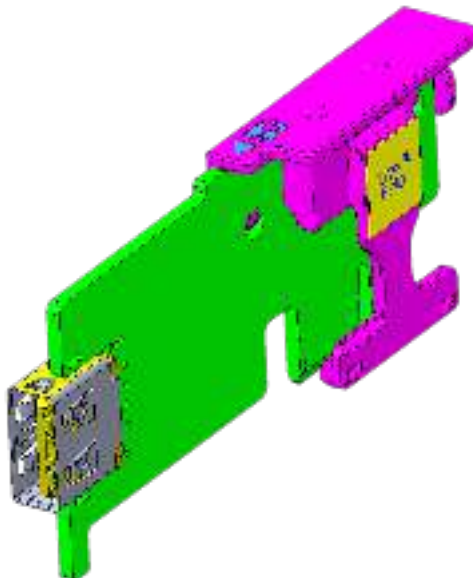

Figure 34. Rear USB

PSU rating

Table 25. PSUs Highline and Lowline ratings

	600 W Platinum	800 W Platinum	DC 1100 W
Peak Power (Highline/-72 VDC)	600 W	800 W	1100 W
Lowline/-40 VDC	600 W	800 W	1100 W
Highline 240 VDC	600 W	800 W	N/A
Highline 200-380 VDC	N/A	N/A	N/A
DC -48-60 V	N/A	N/A	1100 W

The PowerEdge R550 supports up to 2 AC or DC power supplies with 1+1 redundancy, autosensing and auto-switching capability.

If two PSUs are present during POST, a comparison is made between the wattage capacities of the PSUs. In the event that the PSU wattages don't match, the larger of the two PSU's is enabled. Also, there is a PSU mismatch warning displayed in BIOS, iDRAC or on the System LCD.

If a second PSU is added at run-time, in order for that particular PSU to be enabled, the wattage capacity of the first PSU must equal the second PSU. Otherwise, the PSU will be flagged as unmatched in iDRAC and the second PSU will not be enabled.

Dell PSUs have achieved Platinum efficiency levels as shown in the table below.

Table 26. PSU efficiency levels

Efficiency Targets by Load						
Form factor	Output	Class	10%	20%	50%	100%
Redundant 60 mm	600 W AC	Platinum	89.00%	93.00%	94.00%	91.50%
	800 W AC	Platinum	89.00%	93.00%	94.00%	91.50%
	1100 W DC	N/A	85.00%	90.00%	92.00%	90.00%

Environmental Specifications

See the *Dell EMC PowerEdge R750xs Technical Specifications* on www.dell.com/poweredgemanuals for detailed environmental specifications.

Thermal restrictions

See the *Dell EMC PowerEdge R750xs Technical Specifications* on www.dell.com/poweredgemanuals for detailed thermal restrictions.

Appendix B. Standards compliance

The system conforms to the following industry standards.

Table 27. Industry standard documents

Standard	URL for information and specifications
ACPI Advance Configuration and Power Interface Specification, v2.0c	https://uefi.org/specsandtesttools
Ethernet IEEE 802.3-2005	https://standards.ieee.org/
HDG Hardware Design Guide Version 3.0 for Microsoft Windows Server	microsoft.com/whdc/system/platform/pcdesign/desguide/serverdg.msp
IPMI Intelligent Platform Management Interface, v2.0	intel.com/design/servers/ipmi
DDR4 Memory DDR4 SDRAM Specification	jedec.org/standards-documents/docs/jesd79-4.pdf
PCI Express PCI Express Base Specification Rev. 2.0 and 3.0	pcisig.com/specifications/pciexpress
PMBus Power System Management Protocol Specification, v1.2	http://pmbus.org/Assets/PDFS/Public/PMBus_Specification_Part_1_Rev_1-1_20070205.pdf
SAS Serial Attached SCSI, v1.1	http://www.t10.org/
SATA Serial ATA Rev. 2.6; SATA II, SATA 1.0a Extensions, Rev. 1.2	sata-io.org
SMBIOS System Management BIOS Reference Specification, v2.7	dmtf.org/standards/smbios
TPM Trusted Platform Module Specification, v1.2 and v2.0	trustedcomputinggroup.org
UEFI Unified Extensible Firmware Interface Specification, v2.1	uefi.org/specifications
USB Universal Serial Bus Specification, Rev. 2.0	usb.org/developers/docs

Appendix C Additional resources

Table 28. Additional resources

Resource	Description of contents	Location
Installation and Service Manual	This manual, available in PDF format, provides the following information: <ul style="list-style-type: none"> • Chassis features • System Setup program • System indicator codes • System BIOS • Remove and replace procedures • Diagnostics • Jumpers and connectors 	Dell.com/Support/Manuals
Getting Started Guide	This guide ships with the system, and is also available in PDF format. This guide provides the following information: <ul style="list-style-type: none"> • Initial setup steps 	Dell.com/Support/Manuals
Rack Installation Guide	This document ships with the rack kits, and provides instructions for installing a server in a rack.	Dell.com/Support/Manuals
System Information Label	The system information label documents the system board layout and system jumper settings. Text is minimized due to space limitations and translation considerations. The label size is standardized across platforms.	Inside the system chassis cover
Quick Resource Locator (QRL)	This code on the chassis can be scanned by a phone application to access additional information and resources for the server, including videos, reference materials, service tag information, and Dell EMC contact information.	Inside the system chassis cover
Energy Smart Solution Advisor (ESSA)	The Dell EMC online ESSA enables easier and more meaningful estimates to help you determine the most efficient configuration possible. Use ESSA to calculate the power consumption of your hardware, power infrastructure, and storage.	Dell.com/calc