

Dell EMC PowerEdge R250

Technical Guide

Notes, cautions, and warnings

 **NOTE:** A NOTE indicates important information that helps you make better use of your product.

 **CAUTION:** A CAUTION indicates either potential damage to hardware or loss of data and tells you how to avoid the problem.

 **WARNING:** A WARNING indicates a potential for property damage, personal injury, or death.

Chapter 1: System overview	5
New technologies.....	5
Key workloads.....	6
Chapter 2: System features and generational comparison	7
Chapter 3: Chassis views and features	9
Chassis views.....	9
Front view of the system.....	9
Rear view of the system.....	10
Inside the system.....	11
Quick Resource Locator.....	13
Chapter 4: Processor	14
Processor features	14
Supported processors.....	14
Chapter 5: Memory subsystem	15
Supported memory.....	15
Memory speed.....	15
Chapter 6: Storage	16
Storage controllers.....	16
Storage controller feature matrix.....	16
Internal storage configuration.....	17
Server storage controllers User Guide.....	17
iDSDM.....	17
Internal USB.....	19
RAID - Redundant Array of Independent Disks.....	19
Datasheets and PERC performance scaling decks.....	19
Boot Optimized Storage Solution.....	20
Supported Drives.....	20
Hard Disk Drives (HDDs).....	21
Solid State Drives (SSDs).....	23
External Storage.....	23
Chapter 7: Expansion cards and expansion card risers	25
Expansion card installation guidelines.....	25
Chapter 8: Power, thermal, and acoustics	27
Power.....	27
Thermal.....	28
Acoustics.....	28
Acoustical performance.....	28

Chapter 9: Rack, rails, and cable management.....	30
Rack Rails.....	30
Chapter 10: Supported operating systems.....	33
Chapter 11: Dell EMC OpenManage systems management.....	34
Server and Chassis Managers.....	35
Dell EMC consoles.....	35
Automation Enablers.....	35
Integration with third-party consoles.....	35
Connections for third-party consoles.....	35
Dell EMC Update Utilities.....	35
Dell resources.....	35
Chapter 12: Dell Technologies Services	37
Dell EMC ProDeploy Enterprise Suite	37
Dell EMC ProDeploy Plus.....	38
Dell EMC ProDeploy.....	38
Basic Deployment.....	38
Dell EMC Server Configuration Services.....	38
Dell EMC Residency Services.....	38
Dell EMC Remote Consulting Services.....	38
Dell EMC Data Migration Service.....	38
Dell EMC ProSupport Enterprise Suite.....	38
Dell EMC ProSupport Plus for Enterprise.....	39
Dell EMC ProSupport for Enterprise.....	39
Dell EMC ProSupport One for Data Center.....	40
ProSupport for HPC.....	40
Support Technologies.....	41
Dell Technologies Education Services.....	42
Dell Technologies Consulting Services.....	42
Dell EMC Managed Services.....	42
Chapter 13: Appendix A: Additional specifications.....	43
Chassis dimension.....	43
Chassis weight.....	44
Video specifications.....	44
NIC port specifications.....	44
USB Ports.....	45
Internal usb.....	45
Power Supply Units.....	45
Environmental specifications.....	46
Particulate and gaseous contamination specifications.....	47
Thermal restrictions.....	48
Chapter 14: Appendix B. Standards compliance.....	49
Chapter 15: Appendix C Additional resources.....	50

System overview

The Dell EMC™ PowerEdge™ R250 is Dell's latest 1U rack server that is designed to run complex workloads using highly scalable memory. The system features Intel® Xeon E-2300 series processor up to 4 DIMMs, PCI Express® (PCIe) 4.0 enabled expansion cards.

Key capabilities:

- One Intel Xeon E-2300 series processor with up to 8 cores per processor
- Four DDR4 DIMM slots, supports UDIMM 128 GB max, speeds up to 3200 MT/s
- Cabled AC power supply unit
- Up to 4 x 3.5-inch SAS/SATA HDD/SSD drives
- Internal boot: iDRAC9 or internal USB board
- On board LOM 1GbE x2
- BOSS-S1
- PCI Express® (PCIe) 4.0 expansion slots
- RAID: PERC 10.5 and PERC 11 SW and HW RAID
- iDRAC9 with lifecycle controller: Express, Enterprise, Datacenter, and OME advanced features

Topics:

- [New technologies](#)
- [Key workloads](#)

New technologies

Table 1. New technologies

Technology	Detailed Description
Intel® Xeon E-2300 series processor	<ul style="list-style-type: none"> • Core count: Up to 8 cores per processor
Memory	<ul style="list-style-type: none"> • 4 DDR4 DIMM slots, supports UDIMM 128 GB max, speeds up to 3200 MT/s • Supports unregistered ECC DDR4 DIMMs only
Flex IO	<ul style="list-style-type: none"> • LOM board, Broadcom 5720 Dual port GbE x1 • USB 3.0 x1, USB 2.0 x2 and VGA port • Serial port
PCIe	PCI Express® (PCIe)4.0 expansion slots
Chipset (CHPST)	Intel C250 series
Dedicated PERC	Internal controllers: <ul style="list-style-type: none"> • PERC H345 • PERC H355 • HBA355i • H755 External controllers: <ul style="list-style-type: none"> • HBA355e
Power supplies	<ul style="list-style-type: none"> • 450 W Bronze 100-240 V AC, cabled • 450 W Platinum 100-240 V AC, cabled • 700 W Titanium 100-240 V AC, cabled

Table 1. New technologies (continued)

Technology	Detailed Description
	<ul style="list-style-type: none"><li data-bbox="799 262 1497 302">• 700 W Titanium 240 V DC, cabled

Key workloads

PowerEdge R250 is versatile enough to address many customer segments and workloads affordably, that includes:

- SMB and ROBO: Data consolidation, file/print services, mail/messaging services, other collaboration and productivity applications, point of sale and web serving.

System features and generational comparison

The following table shows the comparison between the PowerEdge R250 with the PowerEdge R240.

Table 2. Features comparison

Feature	PowerEdge R250	PowerEdge R240
Processor	One Intel® Xeon E-2300 series processor with up to 8 cores per processor	Coffee Lake-S E3-1200 V6 series. Pentium and Celeron up to 95 W
Memory	<ul style="list-style-type: none"> 4 DDR4 DIMM slots, supports UDIMM 128 GB max, speeds up to 3200 MT/s NOTE: For Pentium processor, maximum memory supported is 2666 MT/s Supports unregistered ECC DDR4 DIMMs only 	<ul style="list-style-type: none"> 4 DDR4 DIMM slots, memory support 8,16 GB, DIMM speed up to 2666 MT/s Supports unregistered ECC DDR4 DIMMs only
Storage drives	<ul style="list-style-type: none"> Up to 4 x 3.5-inch SAS/SATA (HDD/SSD) Up to 4 x 3.5-inch SAS/SATA (HDD/SSD) 2 x 3.5-inch cabled SAS/SATA drives Max 80TB for 4HDD configuration 	<ul style="list-style-type: none"> Up to 4 x 3.5-inch hot-plug SAS/SATA/SSD Up to 4 x 3.5-inch cabled SAS/SATA/SSD Up to 2 x 3.5-inch cabled SAS/SATA/SSD Max 56 TB for 4 HDD configuration
Storage controllers	<p>Internal Controllers</p> <ul style="list-style-type: none"> PERC H345, HBA355i, H755, H355 <p>External Controllers</p> <ul style="list-style-type: none"> HBA355e <p>Software RAID</p> <ul style="list-style-type: none"> S150 	<p>Internal Controllers</p> <ul style="list-style-type: none"> PERC H330, H730p, HBA330 <p>External Controllers</p> <ul style="list-style-type: none"> 12 Gbps SAS HBA <p>Software RAID</p> <ul style="list-style-type: none"> S140
PCIe slots	PCI Express® (PCIe)4.0 expansion slots	2 x PCIe Gen 3 slots
Embedded NIC (LOM)	Onboard LOM 1GbE x2	2 x 1GbE LOM
Networking options (OCP 3.0)	NA	NA
I/O ports	<p>Front Ports</p> <ul style="list-style-type: none"> 1 x iDRAC Direct (Micro-AB USB) port 1 x USB 2.0 <p>Rear Ports</p> <ul style="list-style-type: none"> 1 x USB 2.0 1 x USB 3.0 1 x VGA 1 x Serial 	<p>Front Ports</p> <ul style="list-style-type: none"> 1 x Dedicated iDRAC direct micro-USB 1 x USB 2.0 <p>Rear Ports</p> <ul style="list-style-type: none"> 1 x Serial 2 x USB 3.0 1 x VGA

Table 2. Features comparison (continued)

Feature	PowerEdge R250	PowerEdge R240
	Internal Ports <ul style="list-style-type: none"> ● 1 x USB 3.0 (Optional) 	Internal Ports <ul style="list-style-type: none"> ● 1 x USB 3.0
Form Factor	1U	1U
Power supplies	<ul style="list-style-type: none"> ● 450W Bronze 100-240 VAC, cabled ● 450W Platinum 100-240 VAC, cabled ● 700 W Titanium 100-240 V AC, cabled ● 700 W Titanium 240 V DC, cabled 	<ul style="list-style-type: none"> ● 250 W AC 1U cable (Bronze) ● 450 W AC 1U cable (Platinum)
Embedded management	<ul style="list-style-type: none"> ● iDRAC9 ● iDRAC Direct ● iDRAC Service Module ● iDRAC RESTful API with Redfish 	<ul style="list-style-type: none"> ● iDRAC9 ● iDRAC RESTful API with Redfish ● iDRAC Direct
Front IO	<ul style="list-style-type: none"> ● Power button w/LED x1 ● ID button w/LED x1 ● USB 2.0 x1 ● iDRAC MGMT USB x1 ● System Status LED x1 	<ul style="list-style-type: none"> ● Power button w/LED x1 ● ID button w/LED x1 ● USB 2.0 x1 ● iDRAC MGMT USB x1 ● System Status LED x1

Chassis views and features

Topics:

- Chassis views

Chassis views

Front view of the system

Figure 1. Front view of 4 x 3.5-inch SAS/SATA cable drive system

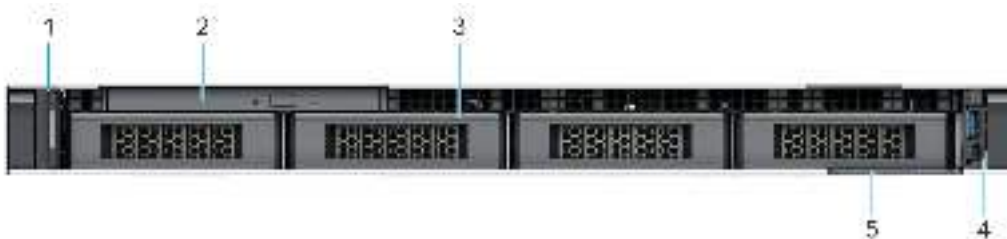

Figure 2. Front view of 4 x 3.5-inch SAS/SATA hot-swap drive system



Figure 3. Front view of 2 x 3.5-inch SAS/SATA cable drive system



Table 3. Features available on the front of the system

Item	Ports, panels, and slots
1	Left control panel
2	Optical drive

Table 3. Features available on the front of the system (continued)

Item	Ports, panels, and slots
3	Drive
4	Right control panel
5	Information tag

Rear view of the system

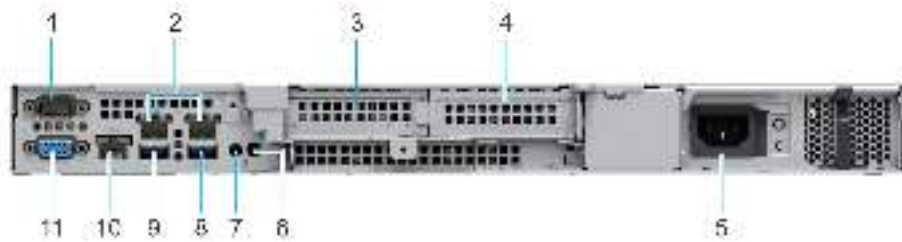

Figure 4. Rear view of the system

Table 4. Rear view of the system ports

Item	Ports, panels, or slots
1	Serial connector
2	Ethernet ports
3	PCIe expansion card slot 1
4	PCIe expansion card slot 2
5	Power supply unit (PSU)
6	System ID button
7	CMA jack
8	USB 3.2 Gen 1 port
9	USB 2.0 port
10	iDRAC ethernet port
11	VGA port

Inside the system

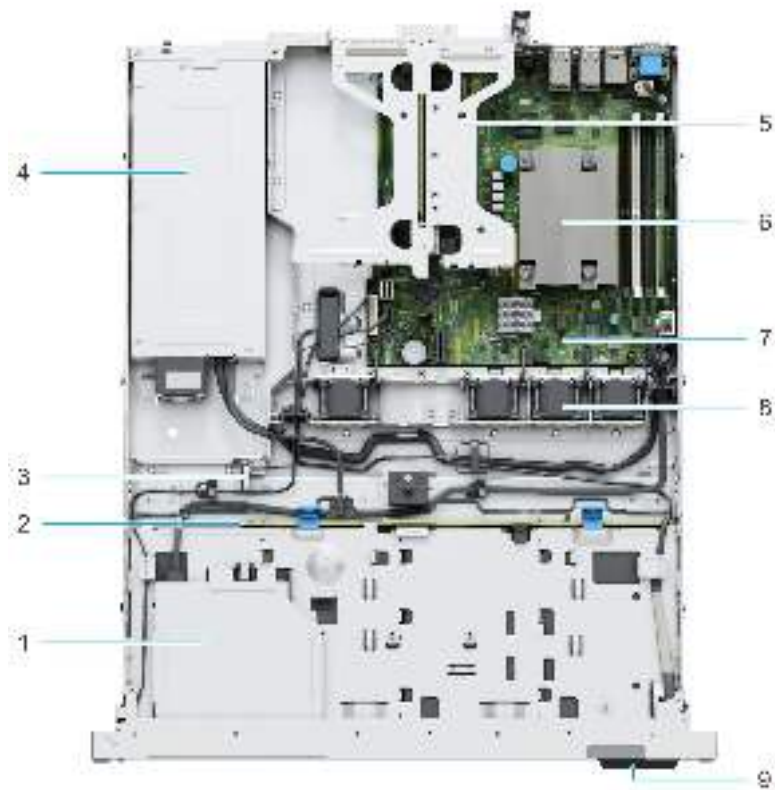

Figure 5. Inside view of the system with backplane

- | | |
|-------------------------|-----------------------------|
| 1. Optical drive | 2. Backplane |
| 3. Intrusion switch | 4. Cabled power supply unit |
| 5. Expansion card riser | 6. Processor heat sink |
| 7. System board | 8. Cooling fans |
| 9. Information tag | |

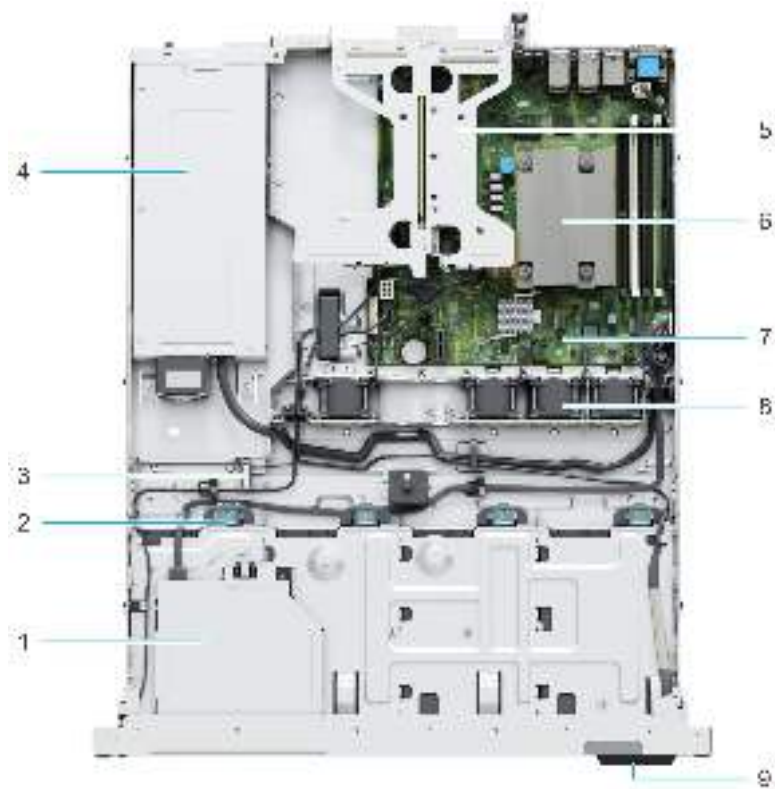

Figure 6. Inside view of the cabled drive system

- | | |
|-------------------------|-----------------------------|
| 1. Optical drive | 2. Cabled drive connector |
| 3. Intrusion switch | 4. Cabled power supply unit |
| 5. Expansion card riser | 6. Processor heat sink |
| 7. System board | 8. Cooling fans |
| 9. Information tag | |

Quick Resource Locator



Figure 7. Quick Resource Locator for R250

Processor



Topics:

- [Processor features](#)
- [Supported processors](#)

Processor features

The 3rd Generation Xeon® Scalable Processors stack is the next generation data center processor offering with the latest features, increased performance, and incremental memory options. This latest generation Xeon Scalable processor supports usages from entry designs that are based on Intel Xeon Silver processors to advanced capabilities offered in new Intel Xeon Platinum processor.

The following lists the features and functions that are in the upcoming 3rd Generation Intel® Xeon Scalable Processor offering:

- More, faster I/O with PCI Express 4 and up to 64 lanes (per socket) at 16 GT/s
- Enhanced Memory Performance with support for up to 3200 MT/s DIMMs

Supported processors

Table 5. Processor BIN stack

Processor	Clock Speed (GHz)	Cache (M)	Cores	Threads	Turbo	Memory Speed (MT/s)	Memory Capacity	TDP
E-2378G	2.8	16	8	16	Turbo	3200	128 GB	80 W
E-2378	2.6	16	8	16	Turbo	3200	128 GB	65 W
E-2356G	3.2	12	6	12	Turbo	3200	128 GB	80 W
E-2336	2.9	12	6	12	Turbo	3200	128 GB	65 W
E-2334	3.4	8	4	8	Turbo	3200	128 GB	65 W
E-2324G	3.1	8	4	4	Turbo	3200	128 GB	65 W
E-2314	2.8	8	4	4	Turbo	3200	128 GB	65 W
G6505	4.2	4	2	4	No Turbo	2666	128 GB	58 W
G6405T	3.5	4	2	4	No Turbo	2666	128 GB	35 W

NOTE: Graphics is not supported with E2300 series processors and cannot be enabled on Dell servers due to restriction in the chipset.

NOTE: Hyper-Threading is enabled by default on all Intel Xeon E-2300 series processors.

Memory subsystem

Topics:

- Supported memory
- Memory speed

Supported memory

Table 6. Memory technology comparison

Feature	PowerEdge R250 (DDR4)
DIMM type	UDIMM
Transfer speed	2933 MT/s, 2666 MT/s, and 3200 MT/s
Voltage	1.2 V (DDR4)

The following table lists the supported DIMMs for the R250 at launch. For the latest information on supported DIMMS, refer to the [Memory NDA Deck](#). For information on memory configuration, post RTS, see the Dell EMC PowerEdge R250 Installation and Service Manual at www.dell.com/poweredgemanuals.

Memory speed

The table below lists the performance details for R250 based on the quantity and type of DIMMs per memory channel.

Table 7. DIMM performance

DIMM type	Rank	Capacity	DIMM rated voltage and speed	DIMMs per Channel (DPC)
UDIMM	1R	8 GB / 16 GB	DDR4 (1.2 V), 3200 MT/s	3200 MT/s
	2R	32 GB	DDR4 (1.2 V), 3200 MT/s	3200 MT/s

Storage

Topics:

- Storage controllers
- Supported Drives
- External Storage

Storage controllers

- PowerEdge Hardware RAID controllers (PERC) series 10, 11 are designed for:
 - Enhanced performance
 - Fault tolerance
 - Simplified management of RAID array drives
- PowerEdge controller series 10, 11 support older legacy SAS and SATA drive interfaces
- Dell S150 is software RAID solution for PowerEdge systems.

Table 8. PERC Series controller offerings

Performance Level	Controller and Description
Entry	S150
Value	H355, H345, HBA355 (Internal)
Premium Performance	H755
External Controllers	HBA355e

NOTE: For more information on the features of the Dell PowerEdge RAID controllers (PERC), Software RAID controllers, or BOSS card, and on deploying the cards, see the storage controller documentation at www.dell.com/storagecontrollermanuals.

NOTE: From December 2021, H355 will replace H345 as the entry raid controller. H345 will be deprecated in January 2022.

Storage controller feature matrix

Table 9. Storage controller feature matrix

Model and Form Factors	Interface Support	PCI Support	SAS Connection	Cache Memory Size	Write Back Cache	RAID Levels	Max Drive Support	RAID Support
PowerEdge Server-Storage Controllers (PERC & SAS HBA) Series 11								
H755 (SAS/SATA Only)	12 Gb/s SAS 6 Gb/s SAS/SATA 3 Gb/s SAS/SATA	PCIe Gen 4	2 x 8 Internal	8 GB NV	Flash-Backed Cache	0,1, 5, 6, 10, 50, 60	16/controller 50 with SAS Expander *Platform limit	Hardware

Table 9. Storage controller feature matrix (continued)

Model and Form Factors	Interface Support	PCI Support	SAS Connection	Cache Memory Size	Write Back Cache	RAID Levels	Max Drive Support	RAID Support
HBA355i Adapter	12 Gb/s SAS 6 Gb/s SAS/SATA 3 Gb/s SAS/SATA	PCIe Gen 4	2 x 8 Internal	N/A	N/A	N/A	16/controller 50 with SAS Expander *Platform limit	N/A
HBA355e Adapter	12 Gb/s SAS 6 Gb/s SAS/SATA 3 Gb/s SAS/SATA	PCIe Gen 4	2 x 8 Internal	N/A	N/A	N/A	240	N/A
H355 Adapter	12Gb/s SAS 6Gb/s SATA	PCIe Gen 4	16 ports- 2 x 8 Internal	No Cache	No Cache	0,1,10 Note ¹	Maximum 32 RAID, or 32 Non-RAID	Hardware RAID
PowerEdge Server-Storage Controllers (PERC & SAS HBA) Series 10								
PERC H345	12 Gb/s SAS 6 Gb/s SATA	PCI-Express 3.1	16 ports- 2 x 8 Internal	No Cache	No Cache	0,1,10 Note ¹	Maximum 32 RAID, or 32 Non-RAID	Hardware RAID
PowerEdge Server-Storage Software RAID								
S150 Software RAID	6 Gb/s SATA	N/A	N/A	No Cache	No Cache	0,1, 5, 10	Maximum 12 SATA	Software RAID - Windows & Linux (Limited) Note 2

NOTE:

1. RAID 5/50 removed from entry RAID card
2. SWRAID support for Linux provides a pre-boot configuration utility to configure MDRAID and degraded boot capability. See User's Guide for details.

This document is updated as changes happen, so for the latest be sure to bookmark it rather than downloading an offline copy or see the [Storage Controller Matrix](#).

Internal storage configuration

Please see the [Factory Configuration Matrix](#) on Sales Portal.

Server storage controllers User Guide

- Server-Storage Controllers User's Guides, click [here](#)

IDSDM

The intended use of IDSDM is to support hypervisor boot: a minimal OS that primarily resides in memory and does not depend on the IDSDM heavily for I/O. Writes, in particular, should be minimized as the SD media can wear out.

The IDSDM card provides the following functions:

- Dual SD interface is maintained in a mirrored configuration (primary and secondary SD).
- Provides full RAID1 functionality.
- Dual SD cards are not required; the module can operate with only one card but will provide no redundancy.
- Enables support for Secure Digital eXtended Capacity (SDXC) cards.
- USB interface to host system.
- I2C interface to host system and onboard EEPROM for out-of-band status reporting.
- Onboard LEDs show status of each SD card.
- A BIOS Setup Redundancy setting supports Mirror Mode or Disabled.

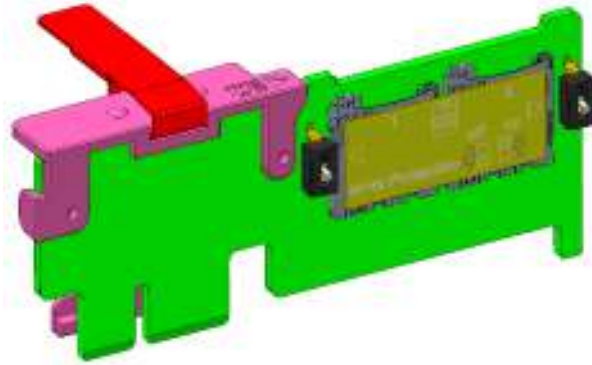

Figure 8. iSDM card

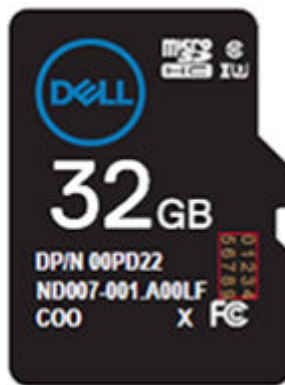

Figure 9. Artwork on uSD for iSDM

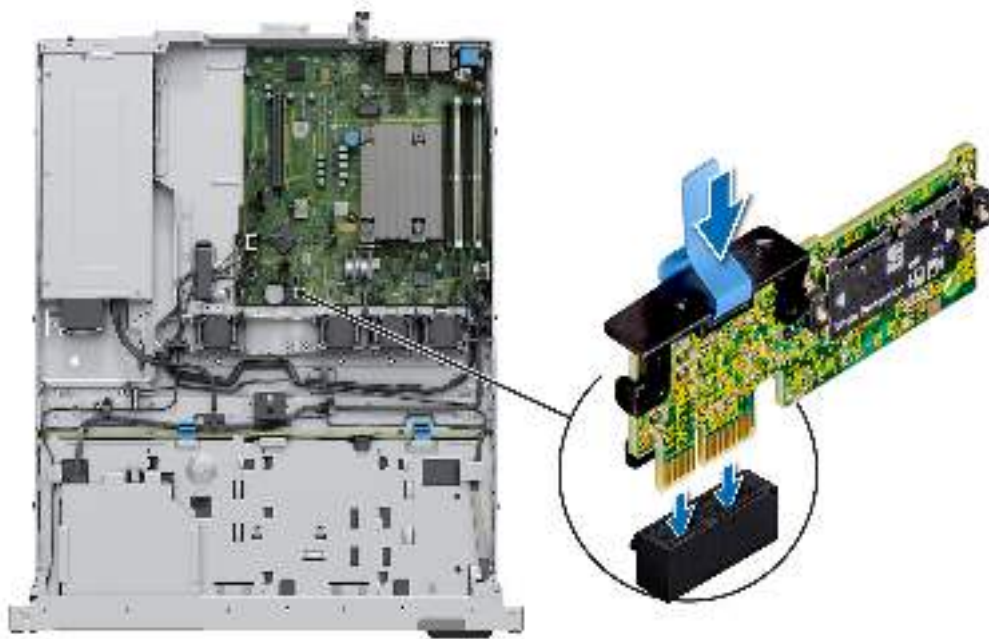

Figure 10. IDSDM

Internal USB



Figure 11. Internal USB

RAID - Redundant Array of Independent Disks

- Link to Help Me Choose: RAID Configuration [here](#)

Datasheets and PERC performance scaling decks

- Resource Page for Server-Storage (Sales Portal) click [here](#)
- PERC & SAS HBA Datasheets (To be updated)

Boot Optimized Storage Solution

Boot Optimized Storage Solution (BOSS) is a RAID solution that is designed for boot optimization and provides a separate RAID/SSD solution allowing customers to maximize server disk slots for data.

Dell provides the following BOSS card for this platform:

- BOSS S1

BOSS feature matrix

Table 10. BOSS feature matrix

BOSS card	Drive Size	RAID levels	Stripe size	Virtual disk cache function	Maximum number of virtual disks	Maximum number of drives supported	Drive types	PCIe support	Disk cache policy	Support for Non-RAIDp disks	Cryptographic digital signature to verify firmware payload	Hot Plug
BOSS S1 Adapter	M.2 devices are read-intensive with 240 GB or 480 GB capacity	RAID 1	Supports default 64K stripe size only	Write through	1	2	6 Gbps M.2 SATA SSDs	Gen2	Drive default	Yes (supports up to two disks)	—	—

Datasheets

- [BOSS S1](#)

BOSS User Guides

- [BOSS S1](#)

Supported Drives

The table shown below lists the internal drives supported by the R250. Refer to Agile for the latest SDL.

Table 11. Supported drives

Form Factor	Type	Speed	Rotational Speed	Capacities
2.5-inch	SATA	6 GB	SSD	480 GB, 960 GB, 1.92 TB, 3.84 TB

Table 11. Supported drives (continued)

Form Factor	Type	Speed	Rotational Speed	Capacities
2.5-inch	SAS/vSAS	12 GB	SSD	400 GB, 800 GB, 960 GB, 1.92 TB, 3.84 TB, 7.68 TB
2.5-inch	SAS	12 GB	10K	600 GB, 1.2 TB, 2.4 TB
2.5-inch	SAS	12 GB	15K	900 GB
3.5-inch	SAS	12 GB	7.2K	2 TB, 4 TB, 8 TB, 12 TB, 16 TB, 20 TB
3.5-inch	SATA	6 GB	7.2K	2 TB, 4 TB, 8 TB, 12 TB, 16 TB, 20 TB
M.2	SATA	6 GB	SSD	240 GB, 480 GB

Hard Disk Drives (HDDs)

Features:

- Two form factors – 2.5-inch and 3.5-inch
- Two interfaces – SAS and NLSAS and SATA
- Interface speeds – 6 GB and 12 GB
- Rotational speeds – 7.2k, 10k and 15k
- Multiple capacities – 600 GB to 18 TB
- Security (Self Encrypting Drive)
- Lower cost than SSDs
- Lower performance compared to SSD
- Formats – 512n and 512e; no 4Kn

HDD facts

A HDD (Hard Disk Drive) is a storage media characterized by a set of spinning platters with arms to move recording heads over the surfaces to the right locations for reading and writing designated data.



Figure 12. Hard disk drives

The heads read or write the data and transfer it through the interface to the server. That interface for Dell standard enterprise HDDs can be either Serial Attached SCSI (SAS) or Serial ATA (SATA) and affects the speed at which data is transferred. Typically, SATA is 6 gigabits/sec. where SAS is 12 gigabits/sec so throughput for SAS can be twice that of SATA. Additionally, due to better signal to noise ratios, SAS can have longer cable lengths, allowing it to connect to external data storage. SAS is also considered a more robust protocol.

Enterprise HDDs are typically used with multiple-user servers running enterprise software. Examples are transaction processing databases, internet infrastructure (email, webserver, e-commerce), scientific computing software, and nearline storage management software. Enterprise drives commonly operate continuously ("24/7") in demanding environments while delivering the highest possible performance without sacrificing reliability.

The fastest enterprise HDDs spin at 10,000 and 15,000 rpm, and can achieve sequential media transfer speeds above 290 MB/s. Drives running at 10,000 or 15,000 rpm use smaller platters to mitigate increased power requirements and therefore generally have lower capacity than the highest capacity 7,200 RPM drives. 10K and 15K drives are labelled Mission Critical or Performance Optimized, while 7.2K are called Business Critical or Capacity Optimized. Since 7.2K drives spin slower they can have larger platters and space for more platters in an HDD case. That allows for higher capacity drives – 16TB, 18TB, ...

Random read/write task speeds are usually measured in IOPs (Input/Output operations per second) and for 15K drives can be up to 290. That may sound like a lot but is dwarfed by IOPS (in the hundreds of thousands) available on SSDs. Here is a link to a chart showing HDD performance characteristics: [HDD_Characteristic_and_Metrics](#).

Depending on workload type, storage device capabilities will be prioritized differently. Below is discussed several capabilities and the media you would select for each.

- Better performance measured in IOPS: Storage performance for random workloads is usually measured in IOPS. When ordered in terms of general IOPS performance, choose 15K, then 10K, then 7.2K and within those SAS HDDs, NL-SAS HDDs, and SATA HDDs.
- Better performance measured in throughput, or gigabytes per second (GB/s): Unless dealing with very heavy sequential workloads that would benefit from flash technology, HDDs are a good choice for most sequential workloads, such as media viewing or database logging. NAND caching can further boost the performance of HDD storage as necessary.
- Lower latency: For workloads sensitive to latency, internal storage on the server itself typically has less latency than storage on external arrays where longer fetch times over the network can greatly add to existing storage latency. It is important to note that SSDs present much lower latency than mechanical HDDs.
- Greater capacity: For capacity-driven workloads, such as email archives, disk-based backup, and object storage applications, high IOPS or throughput performance may be less of a priority as compared to capacity. In this case, choose cost-efficient HDDs, which can offer the greatest capacity at the lowest cost.

While HDDs generally provide lower performance and higher latency than SSDs, they are still an excellent option when used as part of a complete storage strategy that balances cost per GB, capacity, application needs, and performance.

Solid State Drives (SSDs)

SSD Facts

Unlike hard disk drives (HDDs) which use a spinning platter to store data, solid state drives (SSDs) use solid state memory NAND chips. HDDs have several different mechanical moving parts which make them susceptible to handling damage. Solid state drives, on the other hand have no moving parts and are therefore much less susceptible to handling damage even when impacted during use.

SSDs deliver ultra-high-performance input/output operations per second (IOPS), and very low latency for transaction-intensive server and storage applications. Properly used in systems with HDDs, they reduce total cost of ownership (TCO) through low power consumption and low operating temperature.

Dell offers different solid-state drive (SSD) solutions to meet different customer needs. Enterprise SSDs, as a class, are unique compared to client or consumer based SSD in terms of reliability, performance and architecture. While consumer-based SSDs, such as those utilized in notebooks are designed with a focus on consumer-based workloads, rigidity and battery life, enterprise-class SSDs are designed around enterprise application I/O (input/output) requirements with focus points of random I/O performance, reliability, and protection of data during a sudden power-down.

Understanding the basics of enterprise-class SSDs allow customers to make informed decisions when comparing solutions:

- **Over-provisioning:** The Achilles' heel of SSDs are their write characteristics. To rewrite an area of an SSD that has already been written, the data must be erased and then written. In order to overcome a portion of the write performance penalty, Dell enterprise SSDs found across Dell PowerEdge products, all employ a practice known as over-provisioning of Flash. This practice keeps native Flash capacity beyond the user-defined capacity and utilizes the additional space as a scratch pad of sorts to quickly put down application write data on areas of Flash that are already in an erased state. The SSDs perform cleanup functions of this over-provisioned Flash space during time periods typically not impacting application performance.
- **Write Endurance:** Write endurance is the number of program/erase (P/E or write cycles) that can be applied to a block of flash memory before the storage media becomes unreliable. Due to different data center workloads and read/write needs, Dell offers different enterprise SSDs with different endurance ratings so customers can design the right solution for their needs.

Below are the different categories (swim lanes) of enterprise SSDs Dell offers:

- **Write Intensive (WI):** 50/50 read/write workloads with highest endurance. HPC, Database logging, and caching are example workloads.
- **Mix Use (MU):** 70/30 read/write workloads with medium endurance. E-mail/messaging, OLTP, and E-commerce are example workloads.
- **Read Intensive (RI):** 90/10 read/write workloads with lower endurance. Database warehousing, media streaming, and VOD solutions are example workloads.
- **Boot Optimized (Boot):** Lowest cost/small capacity SSDs designed to be used as a boot device in servers. Low endurance.

Dell enterprise SSDs support four kinds of host interface options:

- **SATA SSD:** SATA SSDs are based on the industry standard SATA interface. SATA SSDs provide reasonable performance for enterprise servers.
- **Value SAS:** Value SAS is a new class of SAS SSD that leverages the PowerEdge SAS server infrastructure to deliver SAS like performance at a cost that is competitive with SATA.
- **SAS SSD:** SAS SSDs are based on the industry standard SAS interface. SAS SSDs combine superior reliability, data integrity, and data fail recovery making them suitable for enterprise applications.
- **PCIe SSD:** The Dell PowerEdge Express Flash PCIe SSD is a high-performance solid-state storage device that enables IOPS performance of up to 2000X more than conventional rotating hard drives.
 - SSD Help Me Choose click [here](#)
 - SSD Performance Spec Docs click [here](#)

External Storage

The R250 support the external storage device types listed in the table below.

Table 12. Support external storage devices

Device Type	Description
External Tape	Supports connection to external USB tape products
NAS/IDM appliance software	Supports NAS software stack
JBOD	Supports connection to 12 Gb MD-Series JBODs

Expansion cards and expansion card risers

NOTE: When an expansion card is not supported or missing, riser the iDRAC and Lifecycle Controller logs an event. This does not prevent your system from booting. However, if a F1/F2 pause occurs with an error message, see *Troubleshooting expansion cards* section in the *Dell EMC PowerEdge Servers Troubleshooting Guide* at www.dell.com/poweredgemanuals.

Topics:

- [Expansion card installation guidelines](#)

Expansion card installation guidelines



Figure 13. Expansion card slot connectors

1. Butterfly riser connector

The following table describes the expansion card riser configurations:

Table 13. Expansion card riser configurations

Configurations	Expansion card risers	PCIe Slots	Controlling processor	Height	Length	Slot width	Power
Config 0	Butterfly riser	1	Processor 1	Half height	Half length	x8	25 W
		2	Processor 1	Half height	Half length	x16	25 W

Table 13. Expansion card riser configurations (continued)

Configurations	Expansion card risers	PCIe Slots	Controlling processor	Height	Length	Slot width	Power
Config 1	No riser	N/a	N/a	N/a	N/a	N/a	N/a

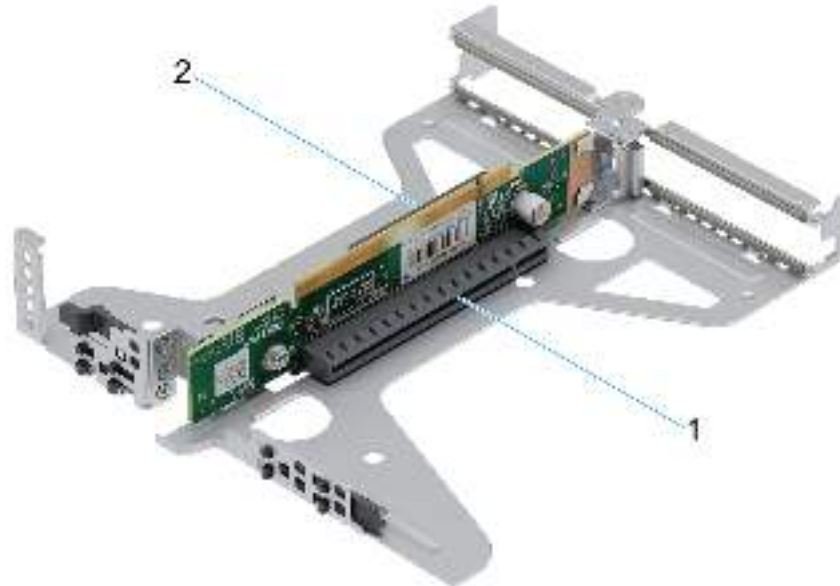

Figure 14. Butterfly riser

1. Slot 2
2. Slot 1

NOTE: The expansion-card slots are not hot-swappable.

For a proper mechanical fit and proper cooling of expansion cards, follow the guidelines in the following table. The expansion cards with the highest priority should be installed first using the slot priority indicated. All the other expansion cards should be installed in the card priority and slot priority order.

Table 14. Configuration 0: Butterfly riser

Card type	Slot priority	Maximum number of cards
Internal PERC adapter	2	1
Dell External Adapter	1, 2	2
Broadcom (NIC: 1Gb)	1, 2	2
Intel (NIC: 1Gb)	1, 2	2
Dell BOSS S1 Module	1, 2	2

NOTE: No expansion cards are supported in the "no riser" configuration.

Power, thermal, and acoustics

PowerEdge servers have an extensive collection of sensors that automatically track thermal activity, which helps regulate temperature thereby reducing server noise and power consumption. The table below lists the tools and technologies Dell offers to lower power consumption and increase energy efficiency.

Topics:

- [Power](#)
- [Thermal](#)
- [Acoustics](#)

Power

Table 15. Power tools and technologies

Feature	Description
Power Supply Units(PSU) portfolio	Dell's PSU portfolio includes intelligent features such as dynamically optimizing efficiency while maintaining availability and redundancy. Find additional information in the Power supply units section.
Tools for right sizing	Enterprise Infrastructure Planning Tool (EIPT) is a tool that can help you determine the most efficient configuration possible. With Dell's EIPT, you can calculate the power consumption of your hardware, power infrastructure, and storage at a given workload. Learn more at www.dell.com/calc .
Industry Compliance	Dell's servers are compliant with all relevant industry certifications and guide lines, including 80 PLUS, Climate Savers and ENERGY STAR.
Power monitoring accuracy	PSU power monitoring improvements include: <ul style="list-style-type: none"> • Dell's power monitoring accuracy is currently 1%, whereas the industry standard is 5% • More accurate reporting of power • Better performance under a power cap
Power capping	Use Dell's systems management to set the power cap limit for your systems to limit the output of a PSU and reduce system power consumption. Dell is the first hardware vendor to leverage Intel Node Manager for circuit-breaker fast capping.
Systems Management	iDRAC Enterprise and Datacenter provides server-level management that monitors, reports and controls power consumption at the processor, memory and system level. Dell OpenManage Power Center delivers group power management at the rack, row, and data center level for servers, power distribution units, and uninterruptible power supplies.
Active power management	Intel Node Manager is an embedded technology that provides individual server-level power reporting and power limiting functionality. Dell offers a complete power management solution comprised of Intel Node Manager accessed through Dell iDRAC9 Datacenter and OpenManage Power Center that allows policy-based management of power and thermal at the individual server, rack, and data center level. Hot spare reduces power consumption of redundant power supplies. Thermal control off a speed optimizes the thermal settings for your environment to reduce fan consumption and lower system power consumption. Idle power enables Dell servers to run as efficiently when idle as when at full workload.
Fresh Air cooling	Refer to ASHRAE A3/A4 Thermal Restriction.

Table 15. Power tools and technologies (continued)

Feature	Description
Rack infrastructure	<p>Dell offers some of the industry's highest-efficiency power infrastructure solutions, including:</p> <ul style="list-style-type: none"> • Power distribution units (PDUs) • Uninterruptible power supplies (UPSs) • Energy Smart containment rack enclosures <p>Find additional information at: https://www.delltechnologies.com/en-us/servers/power-and-cooling.htm.</p>

Thermal

PowerEdge servers have an extensive collection of sensors that automatically track thermal activity, which helps regulate temperature thereby reducing server noise and power consumption.

Acoustics

Acoustical performance

Dell EMC PowerEdge R250 is a rack-mount server appropriate for attended data center environment. In fact, with typical loading condition in 23°C ± 2°C ambient temperature, R250 is suitable for office environment.

Table 16. Acoustical configurations of R250

Configuration	Entry	Economy	Volume	Feature Rich
Processor	1x Intel Rocket Lake, 65 W	1x Intel Rocket Lake, 65 W	1x Intel Rocket Lake, 65 W	Intel Rocket Lake, 80 W
Processor Quantity	1	1	1	1
Memory	8 GB UDIMM	8 GB UDIMM	16 GB UDIMM	32 GB UDIMM
Memory Quantity	1	1	2	4
Apache Pass	N/A	N/A	N/A	N/A
NVDIMM	N/A	N/A	N/A	N/A
Storage	3.5-inch SATA 1-TB (Client drive)	3.5-inch SATA 2-TB (Enterprise drive)	3.5-inch SATA 2-TB	3.5-inch SATA 4-TB
Storage Quantity	1	2	2	4
Backplane	2x 3.5-inch Cabled	4x 3.5-inch Cabled	4x 3.5-inch Hot-plug	4x 3.5-inch Hot-plug
M.2	N/A	N/A	N/A	N/A
Power Supply Unit	450 W (106 mm)	450 W (106 mm)	450 W (106 mm)	450 W (106 mm)
Power Supply Quantity	1	1	1	1
PCI 1	None (Chipset SATA)	None (Chipset SATA)	PERC H355	PERC H355, 2x 1 GbE Broadcom
Bezel	N/A	N/A	Yes	N/A
Other	N/A	N/A	N/A	ODD

Table 17. Acoustical performance of R250 acoustical configurations

Configuration		Entry	Economy	Volume	Feature rich
Acoustical Performance: Idle/ Operating @ 25°C Ambient					
L _{wA,m} (B)	Idle	4.5	4.5	5.0	5.0
	Operating	4.5	4.5	5.0	5.0
K _v (B)	Idle	0.4	0.4	0.4	0.4
	Operating	0.4	0.4	0.4	0.4
L _{pA,m} (dB)	Idle	30	30	33	33
	Operating	30	30	33	33
Prominent tones	No prominent tones in Idle and Operating				
Acoustical Performance: Idle @ 28°C Ambient					
L _{wA,m} (B)		4.5	4.5	5.0	5.0
K _v (B)		0.4	0.4	0.4	0.4
L _{pA,m} (dB)		30	30	33	33
Acoustical Performance: Max. Loading @ 35°C Ambient					
L _{wA,m} (B)		4.9	5.7	5.0	6.3
K _v (B)		0.4	0.4	0.4	0.4
L _{pA,m} (dB)		32	40	33	46

L_{wA,m}: The declared mean A-weighted sound power level (L_{wA}) is calculated per section 5.2 of ISO 9296 (2017) with data collected using the methods described in ISO 7779 (2010). Data presented here may not be fully compliant with ISO 7779.

L_{pA,m}: The declared mean A-weighted emission sound pressure level is at the bystander position per section 5.3 of ISO 9296 (2017) and measured using methods described in ISO 7779 (2010). The system is placed in a 24U rack enclosure, 25 cm above a reflective floor. Data presented here may not be fully compliant with ISO 7779.

Prominent tones: Criteria of D.6 and D.11 of ECMA-74 are followed to determine if discrete tones are prominent and to report them, if so.

Idle mode: The steady-state condition in which the server is energized but not operating any intended function.

Operating mode: The maximum of the steady state acoustical output at 50% of Processor TDP or active HDDs per C.9.3.2 in ECMA-74 .

Rack, rails, and cable management

Key factors in selecting the proper rails include, Identifying:

- Type of rack in which the rails will be installed
- Spacing between the front and rear mounting flanges of the rack
- Type and location of any equipment mounted on the rear of the rack such as power distribution units (PDUs), and the overall depth of the rack

Refer the [DellEMC Enterprise Systems Rail Sizing and Rack Compatibility Matrix](#) for the following information:

- Specific details about rail types and their functionalities
- Rail adjustability ranges for various rack mounting flange types
- Rail depth with and without cable management accessories
- Rack types supported for various rack mounting flange types

Topics:

- [Rack Rails](#)

Rack Rails

The ReadyRails™ static rail system for the Dell EMC PowerEdge R250 provides tool-less support for racks with square or unthreaded round mounting holes including all generations of Dell racks. The rails also offer tooled-mounting support for four-post threaded and two-post (Telco) racks for added versatility.

Rails

The static rails for the R250 support tool-less mounting in 19-inch wide, EIA-310-E compliant square hole and unthreaded round hole racks through the ReadyRails mounting interface. The rails also support a generic mounting interface for tooled mounting in threaded hole and two-post (Telco) racks. Note that screws are not included in the kit due to the fact that threaded racks are offered with a variety of thread designations. Users must therefore provide their own screws when mounting the rails in threaded or two-post racks.

The adjustment range of the rails is a function of the type of rack in which they are being mounted. The Min/Max values listed below represent the allowable distance between the front and rear mounting flanges in the rack. Rail depth represents the minimum depth of the rail as measured from the rack front mounting flanges when the rail rear bracket is positioned all the way forward.

Table 18. Supported rack types

Product	Rail ID	Mounting Interface	Rail Type	Rack Types Supported				
				4-Post			2-Post	
				Square	Round	Thread	Flush	Center
R250	A4	ReadyRails /Generic	Static	√	√	√	√	√

Table 19. Rail adjustment range for supported racks

Adjustment Range											
Product	Rail ID	Mounting Interface	Rail Type	Rail Adjustment Range (mm)						Rail Depth (mm)	
R250	A4	ReadyRails/ Generic	Static	Square		Round		Threaded		Without CMA	With CMA
				Min	Max	Min	Max	Min	Max		
				608	879	594	872	604	890	622	N/A

Cable Management Arm

The static rails for the R250 support a wide variety of racks and mounting configurations, but do not support the ability to extend the system out of the rack for service. Thus, they do not provide support for a cable management arm (CMA).

Rack View

The PowerEdge R250 rails are a “stab-in” design, meaning that the inner (chassis) rail members must first be attached to the sides of the system and then inserted into the outer (cabinet) members installed in the rack.





Figure 15. R250 mounted in the A4 Static Rails in 2-post Center Mount configuration



Figure 16. A4 static rails installed to 4-Post rack

Supported operating systems

The PowerEdge R250 system supports the following operating systems:

- Canonical Ubuntu Server LTS
- VMware ESXi
- Microsoft Windows Server with Hyper-V
- SUSE Linux Enterprise Server
- Red Hat Enterprise Linux

For more information, go to www.dell.com/ossupport.

Dell EMC OpenManage systems management

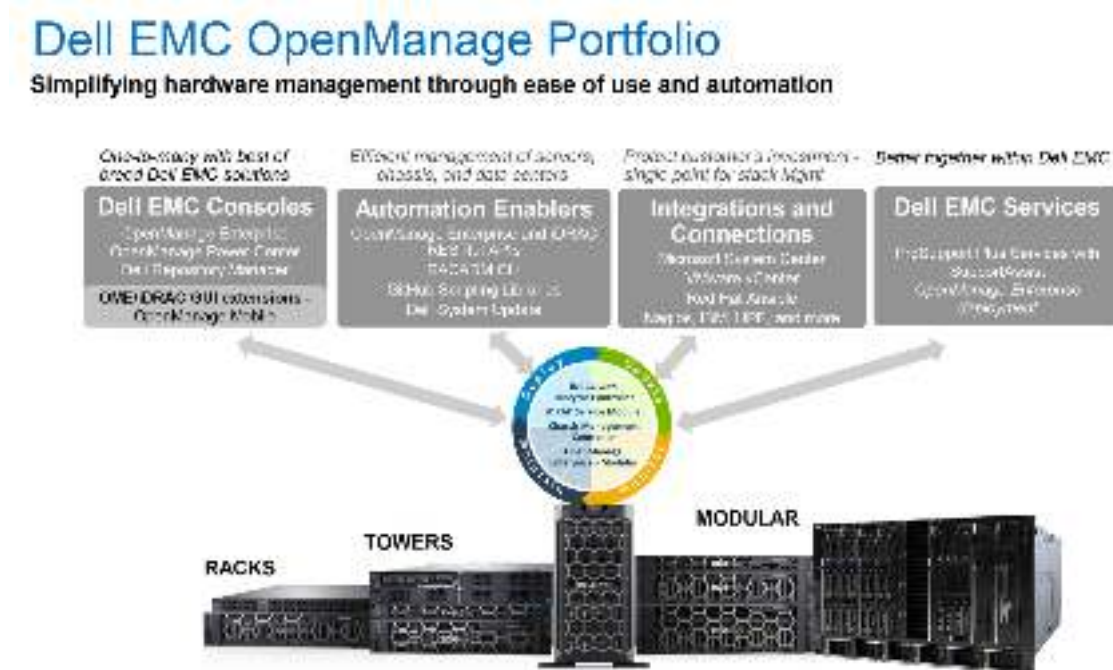

Figure 17. Dell EMC OpenManage Portfolio

Dell EMC delivers management solutions that help IT Administrators effectively deploy, update, monitor, and manage IT assets. OpenManage solutions and tools enable you to quickly respond to problems by helping them to manage Dell EMC servers effectively and efficiently; in physical, virtual, local, and remote environments, operating in-band, and out-of-band (agent-free). The OpenManage portfolio includes innovative embedded management tools such as the integrated Dell Remote Access Controller (iDRAC), Chassis Management Controller and Consoles like OpenManage Enterprise, OpenManage Power Manager plug in, and tools like Repository Manager.

Dell EMC has developed comprehensive systems management solutions based on open standards and has integrated with management consoles that can perform advanced management of Dell hardware. Dell EMC has connected or integrated the advanced management capabilities of Dell hardware into offerings from the industry's top systems management vendors and frameworks such as Ansible, thus making Dell EMC platforms easy to deploy, update, monitor, and manage.

The key tools for managing Dell EMC PowerEdge servers are iDRAC and the one-to-many OpenManage Enterprise console. OpenManage Enterprise helps the system administrators in complete lifecycle management of multiple generations of PowerEdge servers. Other tools such as Repository Manager, which enables simple yet comprehensive change management.

OpenManage tools integrate with systems management framework from other vendors such as VMware, Microsoft, Ansible, and ServiceNow. This enables you to use the skills of the IT staff to efficiently manage Dell EMC PowerEdge servers.

Topics:

- [Server and Chassis Managers](#)
- [Dell EMC consoles](#)
- [Automation Enablers](#)
- [Integration with third-party consoles](#)
- [Connections for third-party consoles](#)
- [Dell EMC Update Utilities](#)
- [Dell resources](#)

Server and Chassis Managers

- Integrated Dell Remote Access Controller (iDRAC)
- iDRAC Service Module (iSM)

Dell EMC consoles

- Dell EMC OpenManage Enterprise
- Dell EMC Repository Manager (DRM)
- Dell EMC OpenManage Enterprise Power Manager plugin to OpenManage Enterprise
- Dell EMC OpenManage Mobile (OMM)

Automation Enablers

- OpenManage Ansible Modules
- iDRAC RESTful APIs (Redfish)
- Standards-based APIs (Python, PowerShell)
- RACADM Command Line Interface (CLI)
- GitHub Scripting Libraries

Integration with third-party consoles

- Dell EMC OpenManage Integrations with Microsoft System Center
- Dell EMC OpenManage Integration for VMware vCenter (OMIVV)
- Dell EMC OpenManage Ansible Modules
- Dell EMC OpenManage Integration with ServiceNow

Connections for third-party consoles

- Micro Focus and other HPE tools
- OpenManage Connection for IBM Tivoli
- OpenManage Plug-in for Nagios Core and XI

Dell EMC Update Utilities

- Dell System Update (DSU)
- Dell EMC Repository Manager (DRM)
- Dell EMC Update Packages (DUP)
- Dell EMC Server Update Utility (SUU)
- Dell EMC Platform Specific Bootable ISO (PSBI)

Dell resources

For additional information about white papers, videos, blogs, forums, technical material, tools, usage examples, and other information, go to the OpenManage page at <https://www.dell.com/openmanagemanuals> or the following product pages:

Table 20. Dell resources

Resource	Location
Integrated Dell Remote Access Controller (iDRAC)	https://www.dell.com/idracmanuals
iDRAC Service Module (iSM)	https://www.dell.com/support/kbdoc/000178050/
OpenManage Ansible Modules	https://www.dell.com/support/kbdoc/000177308/
OpenManage Essentials (OME)	https://www.dell.com/support/kbdoc/000175879/
OpenManage Mobile (OMM)	https://www.dell.com/support/kbdoc/000176046
OpenManage Integration for VMware vCenter (OMIVV)	https://www.dell.com/support/kbdoc/000176981/
OpenManage Integration for Microsoft System Center (OMIMSSC)	https://www.dell.com/support/kbdoc/000147399
Dell EMC Repository Manager (DRM)	https://www.dell.com/support/kbdoc/000177083
Dell EMC System Update (DSU)	https://www.dell.com/support/kbdoc/000130590
Dell EMC Platform Specific Bootable ISO (PSBI)	Dell.com/support/article/sln296511
Dell EMC Chassis Management Controller (CMC)	www.dell.com/support/article/sln311283
OpenManage Connections for Partner Consoles	https://www.dell.com/support/kbdoc/000146912
OpenManage Enterprise Power Manager	https://www.dell.com/support/kbdoc/000176254
OpenManage Integration with ServiceNow (OMISNOW)	Dell.com/support/article/sln317784

 **NOTE:** Features may vary by server. Please refer to the product page on <https://www.dell.com/manuals> for details.

Dell Technologies Services

Dell Technologies Services include a wide, customizable range of service choices to simplify the assessment, design, implementation, management and maintenance of IT environments and to help you transition from platform to platform. Depending on your current business requirements and the level of service right for you, we provide factory, on-site, remote, modular, and specialized services that fit your needs and budget. We'll help with a little or a lot—your choice—and provide access to our global resources.

For more information, see DellEMC.com/Services.

Topics:

- [Dell EMC ProDeploy Enterprise Suite](#)
- [Dell EMC Remote Consulting Services](#)
- [Dell EMC Data Migration Service](#)
- [Dell EMC ProSupport Enterprise Suite](#)
- [Dell EMC ProSupport Plus for Enterprise](#)
- [Dell EMC ProSupport for Enterprise](#)
- [Dell EMC ProSupport One for Data Center](#)
- [ProSupport for HPC](#)
- [Support Technologies](#)
- [Dell Technologies Education Services](#)
- [Dell Technologies Consulting Services](#)
- [Dell EMC Managed Services](#)

Dell EMC ProDeploy Enterprise Suite

ProDeploy Enterprise Suite gets your server out of the box and into optimized production—fast. Our elite deployment engineers with broad and deep experience utilizing best-in-class processes along with our established global scale can help you around the clock and around the globe. From simple to the most complex server installations and software integration, we take the guess work and risk out of deploying your new server technology.

		Basic Deployment	ProDeploy	ProDeploy Plus
Pre-deployment	Single point of contact for project management	-	●	In-region
	Site readiness review	-	●	■
	Implementation planning	-	●	●
	SAM engagement for ProSupport Plus entitled devices	-	-	●
Deployment	Deployment service hours	Business hours	24x7	24x7
	Remote guidance for hardware installation or	Onsite	Remote or Onsite	Onsite
	Onsite hardware installation and packaging material removal	-	Remote	Onsite
	Install and configure system software	-	●	●
	Install support software and connect with Dell Technologies	-	●	●
Project documentation with knowledge transfer	-	●	●	
Post-deployment	Deployment verification	-	●	●
	Configuration data transfer to Dell EMC technical support	-	●	■
	30-days of post-deployment configuration assistance	-	-	●
	Training credits for Dell EMC Education Services	-	-	●

Figure 18. ProDeploy Enterprise Suite capabilities

NOTE: Hardware installation not applicable on selected software products.

Dell EMC ProDeploy Plus

From beginning to end, ProDeploy Plus provides the skill and scale needed to successfully execute demanding deployments in today's complex IT environments. Certified Dell EMC experts start with extensive environmental assessments and detailed migration planning and recommendations. Software installation includes set up of most versions of Dell EMC SupportAssist and OpenManage system management utilities. Post-deployment configuration assistance, testing, and product orientation services are also available.

Dell EMC ProDeploy

ProDeploy provides full service installation and configuration of both server hardware and system software by certified deployment engineers including set up of leading operating systems and hypervisors as well as most versions of Dell EMC SupportAssist and OpenManage system management utilities. To prepare for the deployment, we conduct a site readiness review and implementation planning exercise. System testing, validation, and full project documentation with knowledge transfer complete the process.

Basic Deployment

Basic Deployment delivers worry-free professional installation by experienced technicians who know Dell EMC servers inside and out.

Dell EMC Server Configuration Services

With Dell EMC Rack Integration and other Dell EMC PowerEdge Server Configuration Services, you save time by receiving your systems racked, cabled, tested, and ready to integrate into the data center. Dell EMC staff pre-configure RAID, BIOS and iDRAC settings, install system images, and even install third-party hardware and software.

For more information, see [Server Configuration Services](#).

Dell EMC Residency Services

Residency Services helps customers transition to new capabilities quickly with the assistance of on-site or remote Dell EMC experts whose priorities and time you control. Residency experts can provide post implementation management and knowledge transfer related to a new technology acquisition or day-to-day operational management of the IT infrastructure.

Dell EMC Remote Consulting Services

When you are in the final stages of your PowerEdge server implementation, you can rely on Dell EMC Remote Consulting Services and our certified technical experts to help you optimize your configuration with best practices for your software, virtualization, server, storage, networking, and systems management.

Dell EMC Data Migration Service

Protect your business and data with our single point of contact to manage your data migration project. Your project manager will work with our experienced team of experts to create a plan using industry-leading tools and proven processes based on global best practices to migrate your existing files and data so your business system get up and running quickly and smoothly.

Dell EMC ProSupport Enterprise Suite

With the ProSupport Enterprise Suite, we help keep your IT systems running smoothly, so you can focus on running your business. We will help maintain peak performance and availability of your most essential workloads. ProSupport Enterprise Suite is a suite of support services that enable you to build the solution that is right for your organization.

Choose support models based on how you use technology and where you want to allocate resources. From the desktop to the data center, address everyday IT challenges, such as unplanned downtime, mission-critical needs, data and asset protection, support planning, resource allocation, software application management and more. Optimize IT resources by choosing the right support model.



Figure 19. Dell EMC ProSupport Enterprise Suite

Dell EMC ProSupport Plus for Enterprise

When you purchase your PowerEdge server, we recommend ProSupport Plus, our proactive and preventative support service for your business-critical systems. ProSupport Plus provides you with all the benefits of ProSupport, plus the following:

- An assigned Services Account Manager who knows your business and your environment
- Immediate advanced troubleshooting from an engineer who understands your PowerEdge server
- Personalized, preventive recommendations based on analysis of support trends and best practices from across the Dell Technologies infrastructure solutions customer base to reduce support issues and improve performance
- Predictive analysis for issue prevention and optimization enabled by SupportAssist
- Proactive monitoring, issue detection, notification, and automated case creation for accelerated issue resolution enabled by SupportAssist
- On-demand reporting and analytics-based recommendations enabled by SupportAssist and TechDirect

Dell EMC ProSupport for Enterprise

Our ProSupport service offers highly trained experts around the clock and around the globe to address your IT needs. We help minimize disruptions and maximize availability of PowerEdge server workloads with:

- 24x7 support through phone, chat and online
- Predictive, automated tools and innovative technology
- A central point of accountability for all hardware and software issues
- Collaborative 3rd party support
- Hypervisor, operating system and application support
- Consistent experience regardless of where you are located or what language you speak
- Optional onsite parts and labor response options including next business day or four-hour mission critical

i **NOTE:** Subject to service offer country availability.

Enterprise Support Services Feature Comparison

	Basic	ProSupport	ProSupport Plus
Remote technical support	9x5	24x7	24x7
Covered products	Hardware	Hardware Software	Hardware Software
Onsite hardware support	Next business day	Next business day or 4 hr mission critical	Next business day or 4 hr mission critical
3 rd party collaborative assistance		●	●
Automated issue detection & proactive case creation		●	●
Self-service case initiation and management		●	●
Access to software updates		●	●
Priority access to specialized support experts			●
3 rd party software support			●
Assigned Services Account Manager			●
Personalized assessments and recommendations			●
Semiannual systems maintenance			●

Availability and terms of Dell Technologies services vary by region and by product. For more information, please view our Service Description page at dell.com.

Figure 20. Dell EMC Enterprise Support model

Dell EMC ProSupport One for Data Center

ProSupport One for Data Center offers flexible site-wide support for large and distributed data centers with more than 1,000 assets. This offering is built on standard ProSupport components that leverage our global scale but are tailored to your company's needs. While not for everyone, this service option offers a truly unique solution for Dell Technologies largest customers with the most complex environments.

- Team of assigned Services Account Managers with remote, on-site options
- Assigned ProSupport One technical and field engineers who are trained on your environment and configurations
- On-demand reporting and analytics-based recommendations enabled by SupportAssist and TechDirect
- Flexible on-site support and parts options that fit your operational model
- A tailored support plan and training for your operations staff

ProSupport for HPC

The ProSupport for HPC provides solution-aware support including:

- Access to senior HPC experts
- Advanced HPC cluster assistance: performance, interoperability & configuration
- Enhanced HPC solution level end-to-end support
- Remote pre-support engagement with HPC Specialists during ProDeploy implementation

Learn more at DellEMC.com/HPC-Services.

ProSupport Add-on for HPC

Delivering a true end-to-end support experience across your HPC environment

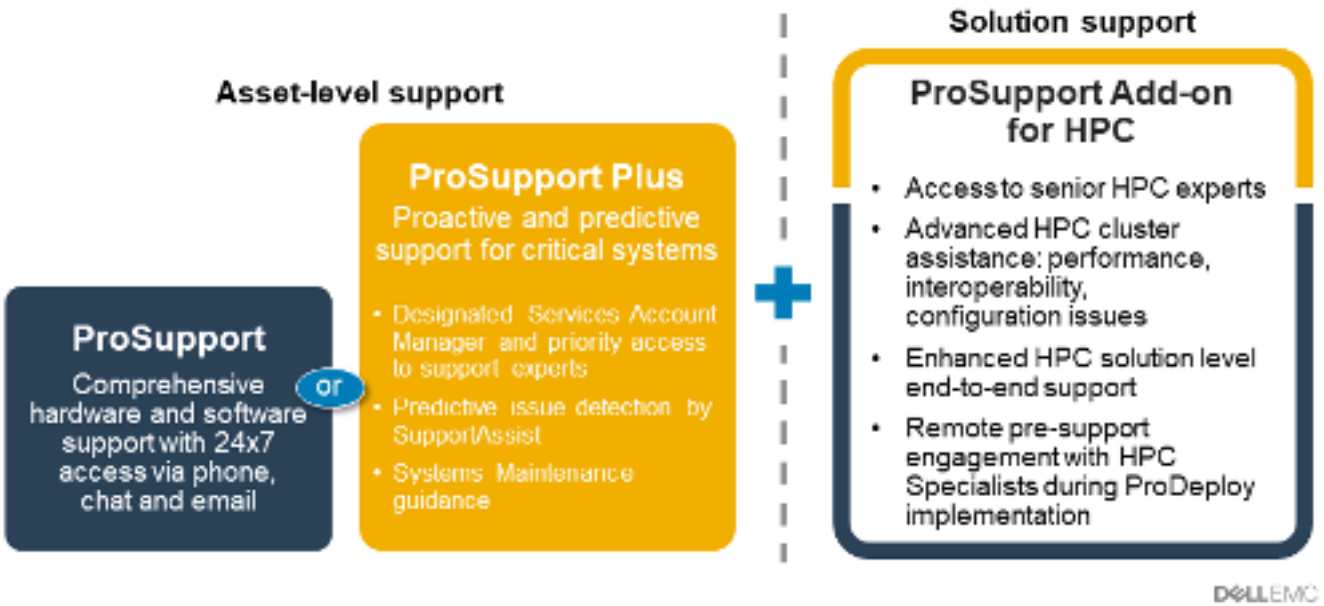

Figure 21. ProSupport for HPC

Support Technologies

Powering your support experience with predictive, data-driven technologies.

Dell EMC SupportAssist

The best time to solve a problem is before it happens. The automated proactive and predictive technology SupportAssist helps reduce steps and time to resolution, often detecting issues before they become a crisis. Benefits include:

- Value—SupportAssist is available to all customers at no additional charge
- Improve productivity—replace manual, high-effort routines with automated support
- Accelerate time to resolution—receive issue alerts, automatic case creation, and proactive contact from Dell EMC experts
- Gain insight and control—optimize enterprise devices with on-demand ProSupport Plus reporting in TechDirect, and get predictive issue detection before the problem starts

NOTE: SupportAssist is included with all support plans, but features vary based on service level agreement.

	Basic Hardware Warranty	ProSupport	ProSupport Plus
Automated issue detection and system state information collection	•	•	•
Proactive, automated case creation and notification		•	•
Predictive issue detection for failure prevention			•
Recommendation reporting available on-demand in TechDirect			•

Figure 22. SupportAssist model

Get started at Dell.com/SupportAssist

Dell EMC TechDirect

Boost IT team productivity when supporting Dell EMC systems. With over 1.4 million self-dispatches processed each year, TechDirect has proven its effectiveness as a support tool. You can:

- Self-dispatch replacement parts
- Request technical support
- Integrate APIs into your help desk

Or, access all your Dell EMC certification and authorization requirements. Train your staff on Dell EMC products, as TechDirect allows you to:

- Download study guides
- Schedule certification and authorization exams
- View transcripts of completed courses and exams

Register at techdirect.dell.

Dell Technologies Education Services

Build the IT skills required to influence the transformational outcomes of the business. Enable talent and empower teams with the right skills to lead and execute transformational strategy that drives competitive advantage. Leverage the training and certification required for real transformation.

Dell Technologies Education Services offers PowerEdge server training and certifications designed to help you achieve more from your hardware investment. The curriculum delivers the information and the practical, hands-on skills that you and your team need to confidently install, configure, manage, and troubleshoot your Dell EMC servers. To learn more or register for a class today, see LearnDell.com/Server.

Dell Technologies Consulting Services

Our expert consultants help you transform faster, and quickly achieve business outcomes for the high value workloads Dell EMC PowerEdge systems can handle.

From strategy to full-scale implementation, Dell Technologies Consulting can help you determine how to execute your IT, workforce, or application transformation.

We use prescriptive approaches and proven methodologies combined with Dell Technologies' portfolio and partner ecosystem to help you achieve real business outcomes. From multi-cloud, applications, DevOps, and infrastructure transformations, to business resiliency, data center modernization, analytics, workforce collaboration, and user experiences—we're here to help.

Dell EMC Managed Services

Reduce the cost, complexity, and risk of managing IT. Focus your resources on digital innovation and transformation while our experts help optimize your IT operations and investment with managed services backed by guaranteed service levels.

Appendix A: Additional specifications

Topics:

- Chassis dimension
- Chassis weight
- Video specifications
- NIC port specifications
- USB Ports
- Power Supply Units
- Environmental specifications

Chassis dimension

The R250 has the following dimensions:

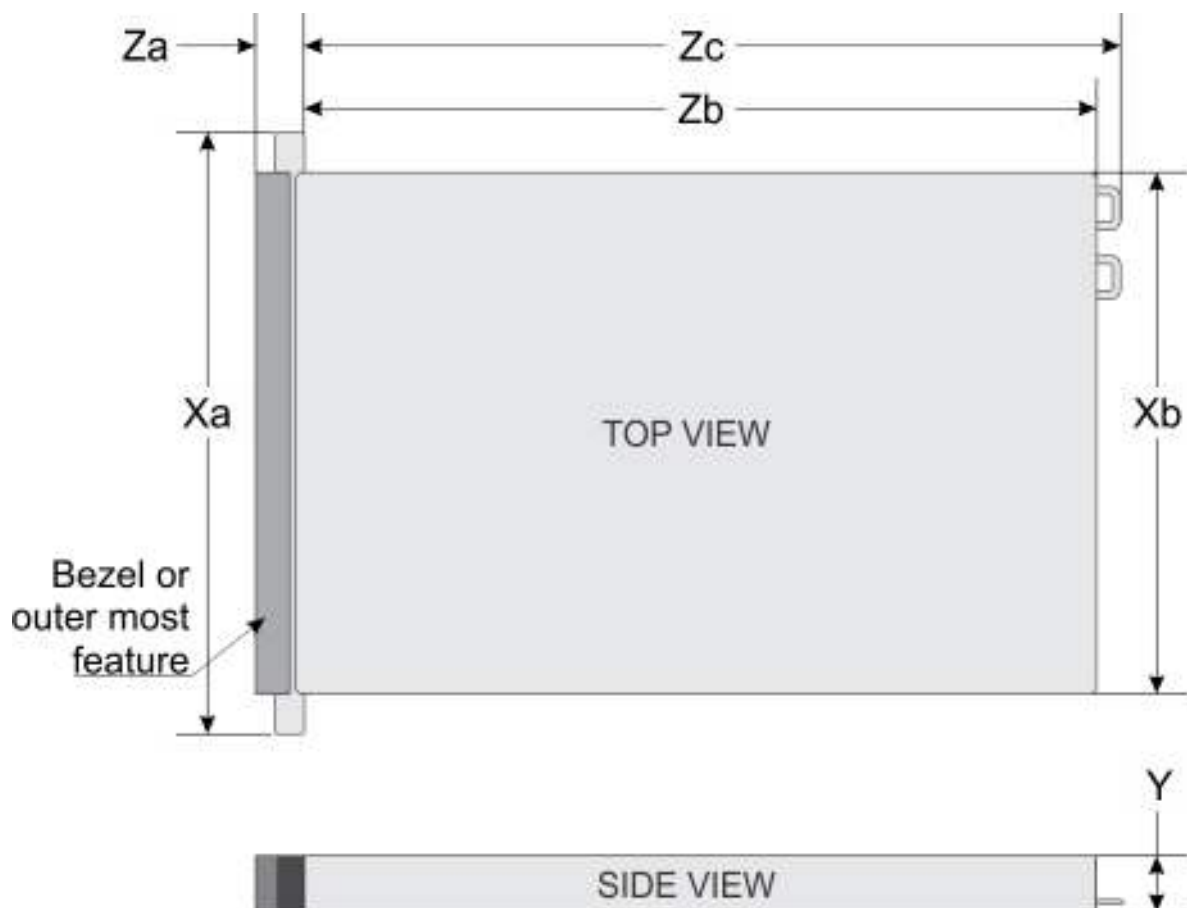

Figure 23. Chassis dimensions

Table 21. Chassis dimensions

Drives	Xa	Xb	Y	Za	Zb	Zc
4 x 3.5-inch and 2 x 3.5-inch	482 mm (18.976 inches)	434 mm (17.08 inches)	42.8 mm (1.685 inches)	22 mm (0.866 inches) without bezel 35.64 mm (1.40 inches) with bezel	534.59 mm (21.04 inches) (Ear to PSU surface)	563 mm (22.16 inches)

NOTE: Zb is the nominal rear wall external surface where the system board I/O connectors reside.

Chassis weight

Table 22. Chassis weight

System	Maximum Weight
4 x 3.5-inch chassis	12.48 kg (27.51 lbs.)
2 x 3.5-inch chassis	

Video specifications

The PowerEdge R250 system supports integrated Matrox G200 graphics controller with 16 MB of video frame buffer.

Table 23. Supported video resolution options for the system

Resolution	Refresh rate (Hz)	Color depth (bits)
1024 x 768	60, 72, 75, 85	8, 16, 32
1280 x 800	60, 75	8, 16, 32
1280 x 1024	60, 75, 85	8, 16, 32
1360 x 768	60	8, 16, 32
1440 x 900	60, 75, 85	8, 16, 32
1600 x 900	60	8, 16, 32
1600 x 1200	60, 65, 70, 75, 85	8, 16, 32
1680 x 1050	60, 75, 85	8, 16, 32
1920 x 1080	60	8, 16, 32
1920 x 1200	60, 75, 85	8, 16, 32

NIC port specifications

The PowerEdge R250 system supports up to two 10/100/1000 Mbps Network Interface Controller (NIC) ports embedded on the Motherboard.

Table 24. NIC port specification for the system

Feature	Specifications
LOM	Onboard LOM 1GbE x 2

USB Ports

Table 25. PowerEdge R250 USB ports specifications

Front		Rear		Internal (Optional)	
USB port type	No. of ports	USB port type	No. of ports	USB port type	No. of ports
USB 2.0-compliant port	One	USB 3.0 port	One	Internal USB 3.0-compliant port	One
iDRAC Direct port (Micro-AB USB 2.0-compliant port)	One	USB 2.0 port	One		

Internal usb

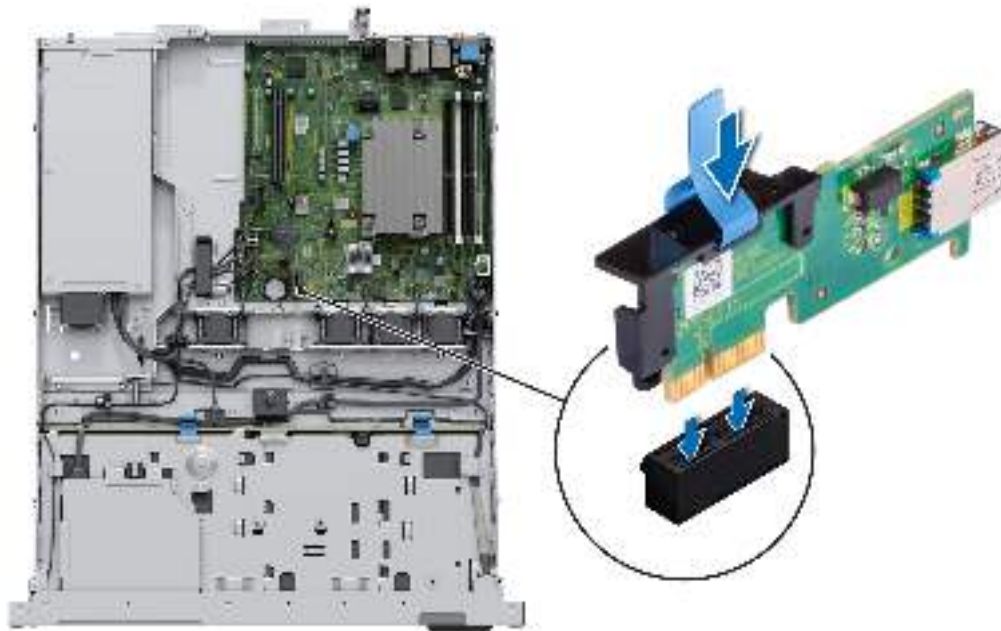

Figure 24. Installing the internal USB card

Power Supply Units

Energy Smart power supplies have intelligent features, such as the ability to dynamically optimize efficiency while maintaining availability and redundancy. Also featured are enhanced power-consumption reduction technologies, such as high-efficiency power conversion and advanced thermal-management techniques, and embedded power-management features, including high-accuracy power monitoring. The table below shows the power supply unit options that are available for the R250.

Table 26. Power supply unit options

PSU	Class	Heat dissipation (maximum)	Frequency	Voltage	AC		DC	Current
					High line 200–240 V	Low line 100–120 V		
450 W AC	Bronze	1871 BTU/hr	50/60 Hz	100–240 V AC, autoranging	450 W	450 W	N/A	6.5 A-3.5 A
450 W AC	Platinum	1725 BTU/hr	50/60 Hz	100–240 V AC, autoranging	450 W	450 W	N/A	6.5 A-3.5 A
700 W AC	Titanium	2625 BTU/hr	50/60 Hz	100–240 V AC, autoranging	700 W	700 W	N/A	4.1 A
700 W Mixed Mode HVDC	Titanium	2625 BTU/hr	N/A	240 V DC	N/A	N/A	700 W	3.4 A

NOTE: Heat dissipation is calculated using the PSU wattage rating.

NOTE: When selecting or upgrading the system configuration, to ensure optimum power utilization, verify the system power consumption with the Enterprise Infrastructure Planning Tool available at Dell.com/calc.

Environmental specifications

NOTE: For additional information about environmental certifications, refer to the *Product Environmental Datasheet* located with the Documentation > Regulatory Information on www.dell.com/support/home.

Table 27. Operational climatic range category A2

Temperature	Specifications
Allowable continuous operations	
Temperature ranges for altitudes <= 900 m (<= 2953 ft)	10–35°C (50–95°F) with no direct sunlight on the equipment
Humidity percent ranges (non-condensing at all times)	8% RH with -12°C minimum dew point to 80% RH with 21°C (69.8°F) maximum dew point
Operational altitude de-rating	Maximum temperature is reduced by 1°C/300 m (1.8°F/984 Ft) above 900 m (2953 Ft)

Table 28. Shared requirements across all categories

Temperature	Specifications
Allowable continuous operations	
Maximum temperature gradient (applies to both operation and non-operation)	20°C in an hour* (36°F in an hour) and 5°C in 15 minutes (9°F in 15 minutes), 5°C in an hour* (9°F in an hour) for tape NOTE: * - Per ASHRAE thermal guidelines for tape hardware, these are not instantaneous rates of temperature change.
Non-operational temperature limits	-40 to 65°C (-40 to 149°F)
Non-operational humidity limits	5% to 95% RH with 27°C (80.6°F) maximum dew point
Maximum non-operational altitude	12,000 meters (39,370 feet)
Maximum operational altitude	3,048 meters (10,000 feet)

Table 29. Maximum vibration specifications

Maximum vibration	Specifications
Operating	0.21 G _{rms} at 5 Hz to 500 Hz for 10 minutes (all x, y, and z axis)
Storage	1.88 G _{rms} at 10 Hz to 500 Hz for 15 minutes (all six sides tested)

Table 30. Maximum shock pulse specifications

Maximum shock pulse	Specifications
Operating	Six consecutively executed shock pulses in the positive and negative x, y, and z axis of 6 G for up to 11 ms. Six consecutively executed shock pulses in the positive and negative x, y, and z axis of 6G for up to 11ms.
Storage	Six consecutively executed shock pulses in the positive and negative x, y, and z axis (one pulse on each side of the system) of 71 G for up to 2 ms

Particulate and gaseous contamination specifications

The following table defines the limitations that prevent the damage to the IT equipment and/or, or both failure from particulate and gaseous contamination. If the levels of particulate or gaseous pollution exceed the specified limitations and results in equipment damage or failure, you must rectify the environmental conditions. Remediation of environmental conditions is the responsibility of the customer.

Table 31. Particulate contamination specifications

Particulate contamination	Specifications
Air filtration	Data center air filtration as defined by ISO Class 8 per ISO 14644-1 with a 95% upper confidence limit. <i>i</i> NOTE: This condition applies to data center environments only. Air filtration requirements do not apply to IT equipment designed to be used outside a data center, in environments such as an office or factory floor. <i>i</i> NOTE: Air entering the data center must have MERV11 or MERV13 filtration.
Conductive dust	Air must be free of conductive dust, zinc whiskers, or other conductive particles. <i>i</i> NOTE: This condition applies to data center and non-data center environments.
Corrosive dust	<ul style="list-style-type: none"> Air must be free of corrosive dust. Residual dust present in the air must have a deliquescent point less than 60% relative humidity. <i>i</i> NOTE: This condition applies to data center and non-data center environments.

Table 32. Gaseous contamination specifications

Gaseous contamination	Specifications
Copper Coupon Corrosion rate	<300 Å/month per Class G1 as defined by ANSI/ISA71.04-2013
Silver Coupon Corrosion rate	<200 Å/month as defined by ANSI/ISA71.04-2013

i **NOTE:** Maximum corrosive contaminant levels measured at ≤50% relative humidity.

Thermal restrictions

ASHRAE A3/A4 Thermal restriction

The following list is the restriction for supporting fresh air in all the platform.

- Four fans population is required.
- Non Dell qualified peripheral cards or peripheral cards greater than 25 W are not supported.

Table 33. Fan population

Chassis	Configuration	Fan Q'ty	Fan Location
4x 3.5-inch hot plug	with Riser card	4x 4028	Fan 1, Fan 2, Fan 3, Fan 4
4x 3.5-inch cabled	w/o Riser card	3x 4028	Fan 2, Fan 3, Fan 4
2x 3.5-inch cabled	with Riser card	3x 4028	Fan 1, Fan 2, Fan 3
	w/o Riser card	2x 4028	Fan 2, Fan 3

Appendix B. Standards compliance

The system conforms to the following industry standards.

Table 34. Industry standard documents

Standard	URL for information and specifications
ACPI Advance Configuration and Power Interface Specification, v2.0c	https://uefi.org/specsandtesttools
Ethernet IEEE 802.3-2005	https://standards.ieee.org/
HDG Hardware Design Guide Version 3.0 for Microsoft Windows Server	microsoft.com/whdc/system/platform/pcdesign/desguide/serverdg.mspx
IPMI Intelligent Platform Management Interface, v2.0	intel.com/design/servers/ipmi
DDR4 Memory DDR4 SDRAM Specification	jedec.org/standards-documents/docs/jesd79-4.pdf
PCI Express PCI Express Base Specification Rev. 2.0 and 3.0	pcisig.com/specifications/pciexpress
PMBus Power System Management Protocol Specification, v1.2	http://pmbus.org/Assets/PDFS/Public/PMBus_Specification_Part_I_Rev_1-1_20070205.pdf
SAS Serial Attached SCSI, v1.1	http://www.t10.org/
SATA Serial ATA Rev. 2.6; SATA II, SATA 1.0a Extensions, Rev. 1.2	sata-io.org
SMBIOS System Management BIOS Reference Specification, v2.7	dmtf.org/standards/smbios
TPM Trusted Platform Module Specification, v1.2 and v2.0	trustedcomputinggroup.org
UEFI Unified Extensible Firmware Interface Specification, v2.1	uefi.org/specifications
USB Universal Serial Bus Specification, Rev. 2.7	usb.org/developers/docs

Appendix C Additional resources

Table 35. Additional resources

Resource	Description of contents	Location
Installation and Service Manual	<p>This manual, available in PDF format, provides the following information:</p> <ul style="list-style-type: none"> • Chassis features • System Setup program • System indicator codes • System BIOS • Remove and replace procedures • Diagnostics • Jumpers and connectors 	Dell.com/Support/Manuals
Getting Started Guide	<p>This guide ships with the system, and is also available in PDF format. This guide provides the following information:</p> <ul style="list-style-type: none"> • Initial setup steps 	Dell.com/Support/Manuals
Rack Installation Guide	<p>This document ships with the rack kits, and provides instructions for installing a server in a rack.</p>	Dell.com/Support/Manuals
System Information Label	<p>The system information label documents the system board layout and system jumper settings. Text is minimized due to space limitations and translation considerations. The label size is standardized across platforms.</p>	Inside the system chassis cover
Quick Resource Locator (QRL)	<p>This code on the chassis can be scanned by a phone application to access additional information and resources for the server, including videos, reference materials, service tag information, and Dell EMC contact information.</p>	Inside the system chassis cover
Enterprise Infrastructure Planning Tool (EIPT)	<p>The Dell EMC online EIPT enables easier and more meaningful estimates to help you determine the most efficient configuration possible. Use EIPT to calculate the power consumption of your hardware, power infrastructure, and storage.</p>	Dell.com/calc