

Dell EMC PowerEdge R250

Installation and Service Manual

Notes, cautions, and warnings

 **NOTE:** A NOTE indicates important information that helps you make better use of your product.

 **CAUTION:** A CAUTION indicates either potential damage to hardware or loss of data and tells you how to avoid the problem.

 **WARNING:** A WARNING indicates a potential for property damage, personal injury, or death.

Chapter 1: About this document.....	6
Chapter 2: PowerEdge R250 system overview.....	7
Front view of the system.....	7
Rear view of the system.....	8
Inside the system	10
System information label.....	11
Rail sizing and rack compatibility matrix.....	13
Locating the Express Service Code and Service Tag.....	13
Chapter 3: Initial system setup and configuration.....	15
Setting up the system.....	15
iDRAC configuration.....	15
Options to set up iDRAC IP address.....	15
Options to log in to iDRAC.....	16
Resources to install operating system.....	17
Options to download firmware	17
Options to download and install OS drivers	17
Downloading drivers and firmware.....	18
Chapter 4: Minimum to POST and system management configuration validation.....	19
Minimum configuration to POST	19
Configuration validation.....	19
Error messages.....	20
Chapter 5: Installing and removing system components.....	21
Safety instructions.....	21
Before working inside your system.....	22
After working inside your system.....	22
Recommended tools.....	22
Optional front bezel.....	23
Removing the front bezel.....	23
Installing the front bezel.....	23
System cover.....	24
Removing the system cover.....	24
Installing the system cover.....	25
Optional optical drive.....	26
Removing the optical drive.....	26
Installing the optical drive.....	27
Air shroud.....	29
Removing the air shroud.....	29
Installing the air shroud.....	29
Cooling fans.....	30
Removing a cooling fan.....	30

Installing a cooling fan.....	31
Intrusion switch	32
Removing the intrusion switch module.....	32
Installing the intrusion switch.....	33
Drive backplane.....	34
Drive backplane.....	34
Removing the backplane	35
Installing the drive backplane.....	35
Drives.....	36
Removing a drive blank.....	36
Installing a drive blank.....	37
Removing a cabled drive.....	37
Installing a cabled drive.....	38
Removing the drive carrier.....	39
Installing the drive carrier.....	40
Removing the drive from the drive carrier.....	41
Installing the drive into the drive carrier.....	42
Cable routing.....	43
System memory.....	47
System memory guidelines.....	47
General memory module installation guidelines.....	48
Removing a memory module.....	48
Installing a memory module.....	49
Processor and heat sink	50
Removing the heat sink.....	50
Removing the processor.....	51
Installing the processor.....	52
Installing the heat sink	53
Expansion cards and expansion card risers.....	54
Expansion card installation guidelines.....	55
Removing the expansion card risers.....	56
Installing the expansion card risers.....	58
Removing expansion card from the expansion card riser.....	58
Installing an expansion card into the expansion card riser.....	59
Optional IDSDM module.....	61
Removing the IDSDM module.....	61
Installing the IDSDM module.....	62
MicroSD card.....	62
Removing the Micro-SD card.....	62
Installing the Micro-SD card.....	63
Optional BOSS S1 card.....	64
Removing the M.2 SSD module.....	64
Installing the M.2 SSD module.....	65
PERC.....	66
Removing the adapter PERC.....	66
Installing the adapter PERC.....	67
System battery	68
Replacing the system battery.....	68
Optional internal USB card.....	70
Removing the internal USB key.....	70

Installing the internal USB key.....	71
Power supply unit.....	71
Removing the cabled power supply unit.....	71
Installing a power supply unit.....	72
System board.....	73
Removing the system board.....	73
Installing the system board.....	74
Trusted Platform Module.....	77
Upgrading the Trusted Platform Module.....	77
Initializing TPM for users.....	78
Initializing the TPM 1.2 for users.....	78
Initializing the TPM 2.0 for users.....	78
Control panel.....	78
Removing the left control panel.....	78
Installing the left control panel.....	79
Removing the right control panel.....	80
Installing the right control panel.....	81
Chapter 6: Jumpers and connectors.....	83
System board connectors.....	83
System board jumper settings.....	84
Disabling a forgotten password.....	84
Chapter 7: System diagnostics and indicator codes.....	86
Non-redundant cabled power supply unit indicator codes.....	86
Using system diagnostics.....	86
Dell Embedded System Diagnostics.....	87
Chapter 8: Getting help.....	88
Recycling or End-of-Life service information.....	88
Contacting Dell Technologies.....	88
Accessing system information by using QRL.....	88
Quick Resource Locator for PowerEdge R250 system.....	89
Receiving automated support with SupportAssist	89
Chapter 9: Documentation resources.....	91

About this document

This document provides an overview about the system, information about installing and replacing components, diagnostic tools, and guidelines to be followed while installing certain components.

PowerEdge R250 system overview

The PowerEdge R250 system is a 1U server that supports:

- One Intel Xeon E-2300 series processor with up to 8 + 2 execution cores per processor or Intel Pentium processor with 2 cores
- Four DDR4 DIMM slots
- One cabled AC power supply unit
- Up to four 3.5-inch SAS/SATA hot-plug drives or up to four 3.5-inch SATA cabled drives.

NOTE: All instances of SAS, SATA drives are referred to as drives in this document, unless specified otherwise.

NOTE: For more information, see the *Dell EMC PowerEdge R250 Technical Specifications* on the product documentation page.

Topics:

- [Front view of the system](#)
- [Rear view of the system](#)
- [Inside the system](#)
- [System information label](#)
- [Rail sizing and rack compatibility matrix](#)
- [Locating the Express Service Code and Service Tag](#)

Front view of the system

Figure 1. Front view of 4 x 3.5-inch cabled SAS/SATA drive system

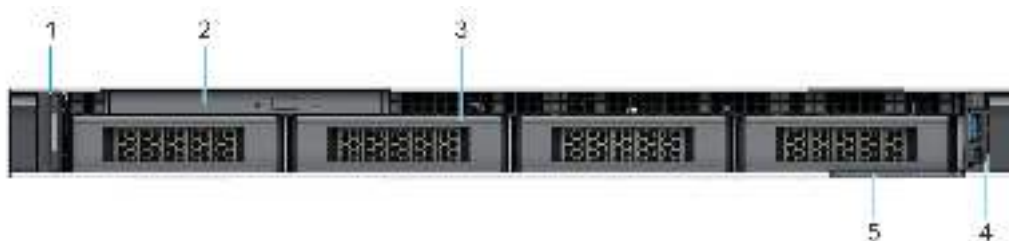

Figure 2. Front view of 4 x 3.5-inch SAS/SATA hot-swap drive system



Figure 3. Front view of 2 x 3.5-inch cabled SAS/SATA drive system



Table 1. Features available on the front of the system

Item	Ports, panels, and slots	Icon	Description
1	Left control panel with iDRAC reset button		Contains the system health, and system ID. NOTE: To reset the iDRAC without changing any saved settings press and hold the System Identification button for at least 16 seconds.
2	Optical drive	N/A	One optional slim SATA DVD-ROM drive or DVD+/-RW drive.
3	Drive	N/A	Enables you to install drives that are supported on your system.
4	Right control panel	N/A	Contains the power button, USB port, iDRAC Direct micro port, and the iDRAC Direct status LED.
5	Information tag	N/A	The Information tag is a slide-out label panel that contains system information such as Service Tag, NIC, MAC address, and so on. If you have opted for the secure default access to iDRAC, the Information tag also contains the iDRAC secure default password.

NOTE: For more information, see the *Dell EMC PowerEdge R250 Technical Specifications* on the product documentation page.

Rear view of the system

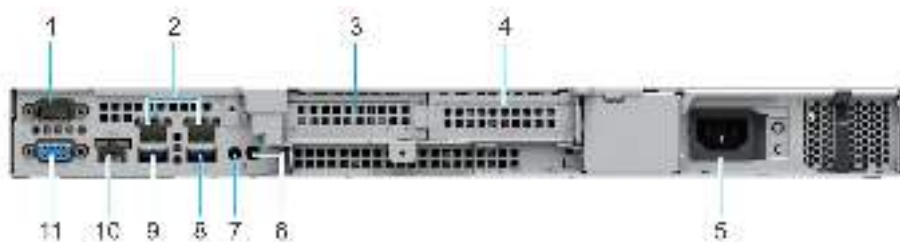







Figure 4. Rear view of the system

Table 2. Rear view of the system

Item	Ports, panels, or slots	Icon	Description
1	Serial port	N/a	Enables you to connect serial devices to the system.
2	Ethernet ports		The Ethernet ports that are integrated on the system board provide network connectivity. These NIC ports can also be shared with iDRAC when iDRAC network settings is set to shared mode.
3	PCIe expansion card slot 1	N/a	Enables you to connect PCI Express expansion cards.
4	PCIe expansion card slot 2	N/a	Enables you to connect PCI Express expansion cards.
5	Cabled power supply unit		Indicates the PSU.

Table 2. Rear view of the system (continued)

Item	Ports, panels, or slots	Icon	Description
6	System ID button		<p>Press the system ID button:</p> <ul style="list-style-type: none"> To locate a particular system within a rack. To turn the system ID on or off. <p>To reset iDRAC, press and hold the button for more than 16 seconds.</p> <p>i NOTE:</p> <ul style="list-style-type: none"> To reset iDRAC using system ID, ensure that the system ID button is enabled in the iDRAC setup. If the system stops responding during POST, press and hold the system ID button (for more than 5 seconds) to enter the BIOS progress mode. LED.
7	CMA jack	N/a	Enables you to connect to cable management arm
8	USB 3.2 Gen 1 port		This port is USB 3.0-compliant.
9	USB 2.0 port		This port is USB 2.0-compliant.
10	iDRAC ethernet port		Enables you to remotely access iDRAC. For more information, see the iDRAC User's Guide at www.dell.com/poweredgemanuals
11	VGA port		Enables you to connect a display device to the system.

i NOTE: For more information, see the *Dell EMC PowerEdge R250 Technical Specifications* on the product documentation page.

Inside the system

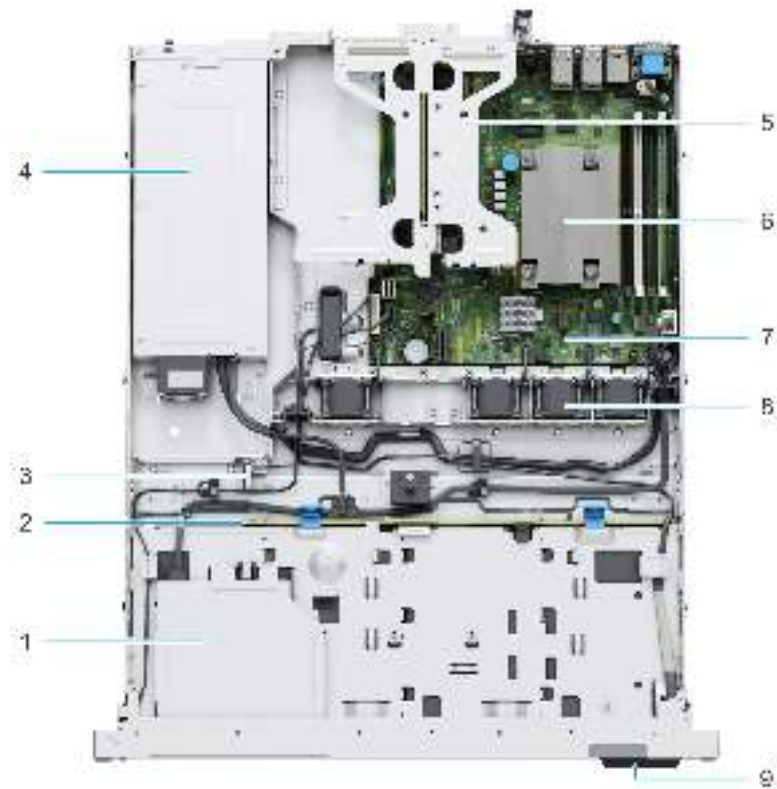

Figure 5. Inside view of the system with backplane

- | | |
|-------------------------|-----------------------------|
| 1. Optical drive | 2. Backplane |
| 3. Intrusion switch | 4. Cabled power supply unit |
| 5. Expansion card riser | 6. Processor heat sink |
| 7. System board | 8. Cooling fans |
| 9. Information tag | |

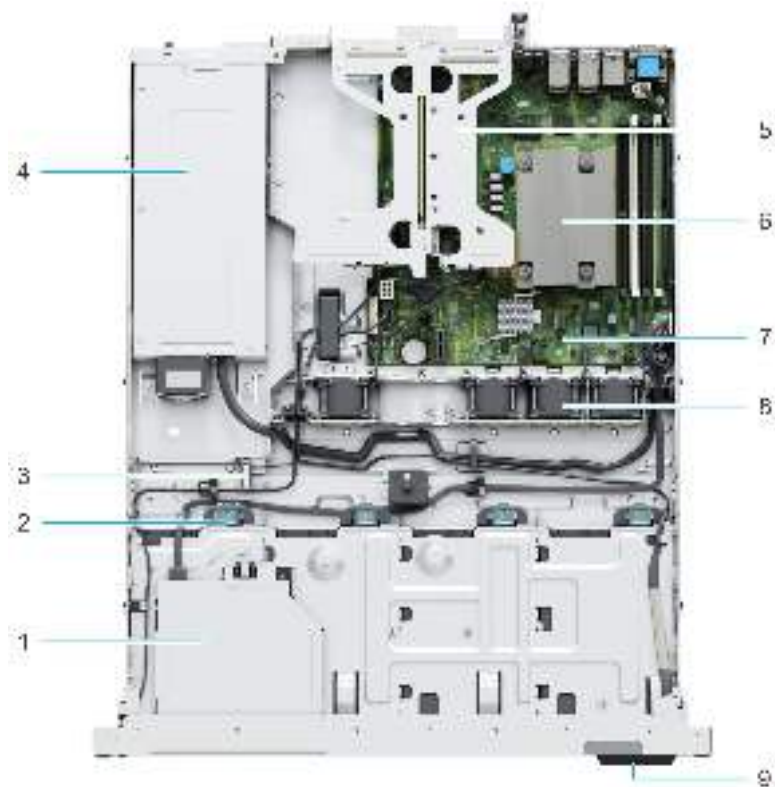

Figure 6. Inside view of the cabled drive system

- | | |
|-------------------------|-----------------------------|
| 1. Optical drive | 2. Cabled drive connector |
| 3. Intrusion switch | 4. Cabled power supply unit |
| 5. Expansion card riser | 6. Processor heat sink |
| 7. System board | 8. Cooling fans |
| 9. Information tag | |

System information label

The system information label is located on the back of the system cover.

Figure 7. Express service tag

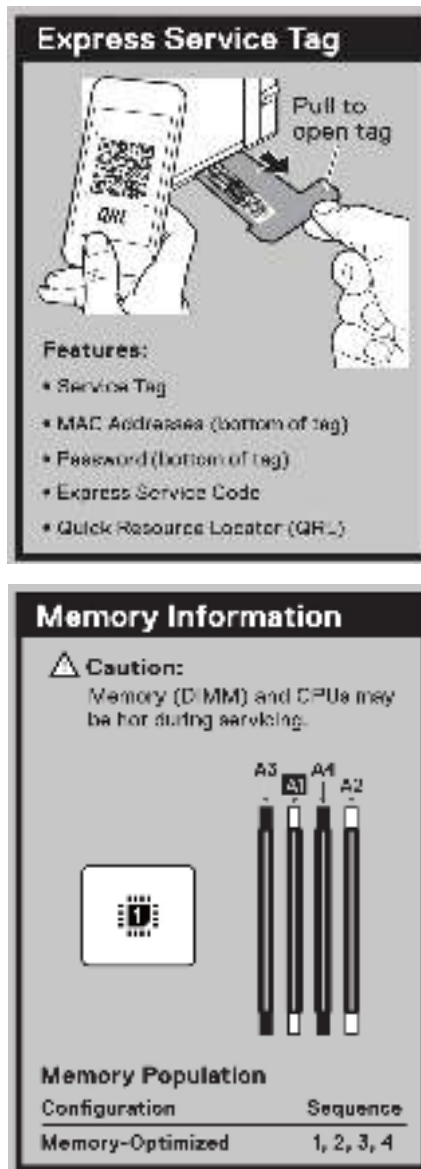

Figure 8. Memory information

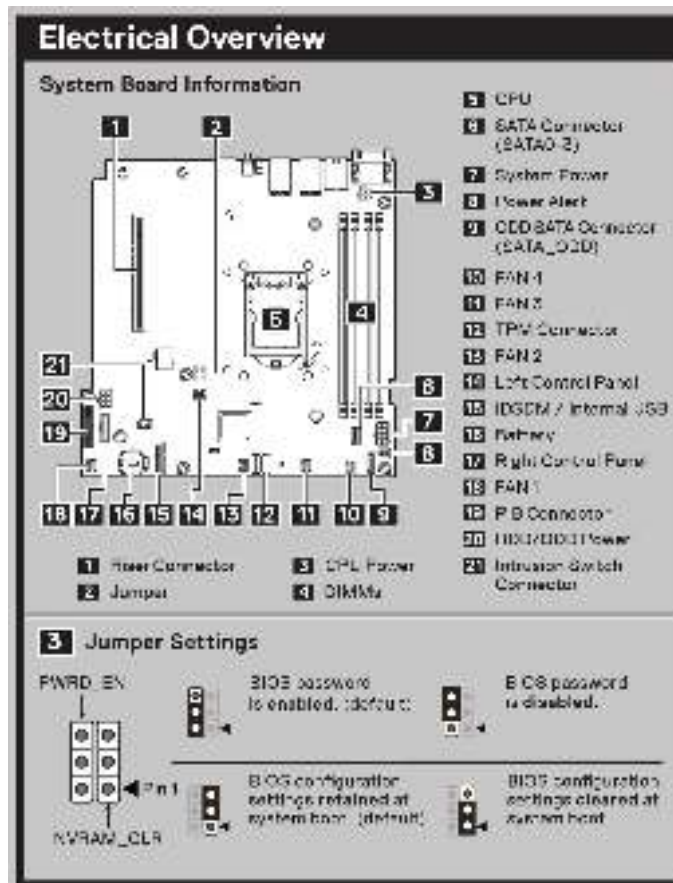

Figure 9. Electrical overview

Rail sizing and rack compatibility matrix

For specific information about the rail solutions compatible with your system, see the *Dell EMC Enterprise Systems Rail Sizing and Rack Compatibility Matrix* available at https://i.dell.com/sites/csdocuments/Business_solutions_engineering-Docs_Documents/en/rail-rack-matrix.pdf.

The document provides the information that is listed below:

- Specific details about rail types and their functionalities.
- Rail adjustability range for various types of rack mounting flanges.
- Rail depth with and without cable management accessories.
- Types of racks supported for various types of rack mounting flanges.

Locating the Express Service Code and Service Tag

The unique Express Service Code and Service Tag are used to identify the system.

The information tag is located on the front of the system that includes system information such as the Service Tag, Express Service Code, Manufacture date, NIC, MAC address, QRL label, and so on. If you have opted for the secure default access to iDRAC, the Information tag also contains the iDRAC secure default password.

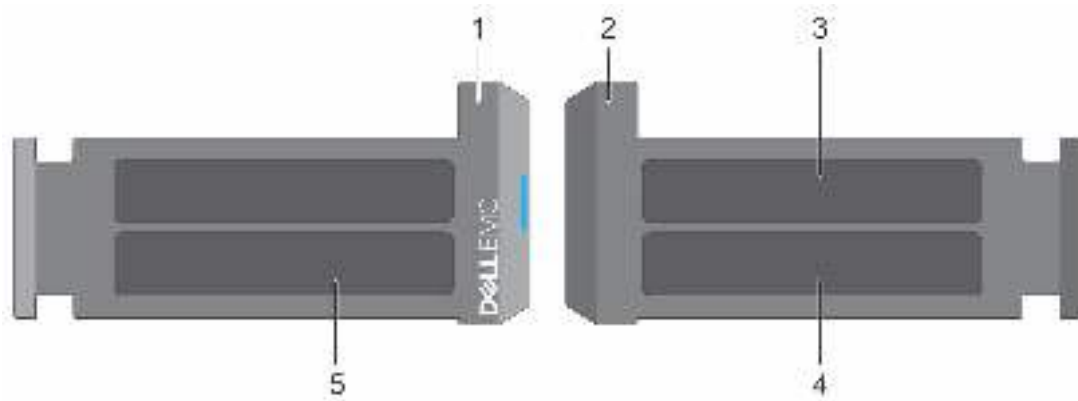

Figure 10. Locating the Express Service Code and Service tag

1. Information tag (front view)
2. Information tag (back view)
3. OpenManage Mobile (OMM) label
4. iDRAC MAC address and iDRAC secure password label
5. Service Tag, Express Service Code, QRL label

The Mini Enterprise Service Tag (MEST) label is located on the rear of the system that includes the Service Tag (ST), Express Service Code (Exp Svc Code), and Manufacture Date (Mfg. Date). The Exp Svc Code is used by Dell EMC to route support calls to the appropriate personnel.

Alternatively, the Service Tag information is located on a label on the left wall of the chassis.

Initial system setup and configuration

This section describes the tasks for initial setup and configuration of the Dell EMC system. The section also provides general steps to set up the system and the reference guides for detailed information.

Topics:

- [Setting up the system](#)
- [iDRAC configuration](#)
- [Resources to install operating system](#)

Setting up the system

Perform the following steps to set up the system:

Steps

1. Unpack the system.
2. Install the system into the rack. For more information, see the rail installation and cable management accessory guides relevant to your rail and cable management solution at www.dell.com/poweredgemanuals.
3. Connect the peripherals to the system and the system to the electrical outlet.
4. Power on the system.

For more information about setting up the system, see the *Getting Started Guide* that is shipped with your system.

NOTE: For information about managing the basic settings and features of the system, see the *Dell Technologies PowerEdge R250 BIOS and UEFI Reference Guide* on the product documentation page.

NOTE: Legacy BIOS is not supported on the system, only UEFI BIOS is supported.

iDRAC configuration

The Integrated Dell Remote Access Controller (iDRAC) is designed to make you more productive as a system administrator and improve the overall availability of Dell EMC servers. iDRAC alerts you to system issues, helps you to perform remote management, and reduces the need for physical access to the system.

NOTE: To reset iDRAC, see [how to reset iDRAC](#).

Options to set up iDRAC IP address

To enable communication between your system and iDRAC, you must first configure the network settings based on your network infrastructure. The network settings option is set to **DHCP**, by default.

NOTE: For static IP configuration, you must request for the settings at the time of purchase.

You can set up the iDRAC IP address using one of the interfaces in the table below. For information about setting up iDRAC IP address, see the documentation links provided in the table below.

Table 3. Interfaces to set up iDRAC IP address

Interface	Documentation links
iDRAC Settings utility	<i>Integrated Dell Remote Access Controller User's Guide</i> at https://www.dell.com/idracmanuals or for system specific <i>Integrated Dell Remote Access Controller User's Guide</i> ,

Table 3. Interfaces to set up iDRAC IP address (continued)

Interface	Documentation links
	<p>go to https://www.dell.com/poweredge/manuals > Product Support page of your system > Documentation.</p> <p>NOTE: To determine the most recent iDRAC release for your platform and for latest documentation version, see KB article https://www.dell.com/support/article/sln308699.</p>
OpenManage Deployment Toolkit	<p><i>Dell EMC OpenManage Deployment Toolkit User's Guide</i> available at https://www.dell.com/openmanage/manuals > Open Manage Deployment Toolkit.</p>
iDRAC Direct	<p><i>Integrated Dell Remote Access Controller User's Guide</i> at https://www.dell.com/idrac/manuals or for system specific <i>Integrated Dell Remote Access Controller User's Guide</i>, go to https://www.dell.com/poweredge/manuals > Product Support page of your system > Documentation.</p> <p>NOTE: To determine the most recent iDRAC release for your platform and for latest documentation version, see KB article https://www.dell.com/support/article/sln308699.</p>
Lifecycle Controller	<p><i>Dell Lifecycle Controller User's Guide</i> at https://www.dell.com/idrac/manuals or for system specific <i>Dell Lifecycle Controller User's Guide</i>, go to https://www.dell.com/poweredge/manuals > Product Support page of your system > Documentation.</p> <p>NOTE: To determine the most recent iDRAC release for your platform and for latest documentation version, see KB article https://www.dell.com/support/article/sln308699.</p>

NOTE: To access iDRAC, ensure that you connect the ethernet cable to the iDRAC dedicated network port or use the iDRAC Direct port by using the USB cable. You can also access iDRAC through the shared LOM mode, if you have opted for a system that has the shared LOM mode enabled.

Options to log in to iDRAC

To log in to the iDRAC Web User Interface, open a browser and enter the IP address.

You can log in to iDRAC as:

- iDRAC user
- Microsoft Active Directory user
- Lightweight Directory Access Protocol (LDAP) user

In the login screen displayed, if you have opted for secure default access to iDRAC, enter the iDRAC secure default password available on back of the Information Tag. If you have not opted for secure default access to iDRAC, enter the default user name and password – `root` and `calvin`. You can also log in by using your Single Sign-On or Smart Card.

NOTE: Ensure that you change the default username and password after setting up the iDRAC IP address.

For more information about logging in to the iDRAC and iDRAC licenses, see the latest *Integrated Dell Remote Access Controller User's Guide* at www.dell.com/idrac/manuals.

NOTE: To determine the most recent iDRAC release for your platform and for latest documentation version, see KB article <https://www.dell.com/support/article/sln308699>.



You can also access iDRAC using command-line protocol - RACADM. For more information, see the *Integrated Dell Remote Access Controller RACADM CLI Guide* available at <https://www.dell.com/idrac/manuals>.

You can also access iDRAC using automation tool - Redfish API. For more information, see the *Integrated Dell Remote Access Controller User's Guide Redfish API Guide* available at <https://developer.dell.com>.

Resources to install operating system

If the system is shipped without an operating system, you can install a supported operating system by using one of the resources provided in the table below. For information about how to install the operating system, see the documentation links provided in the table below.

Table 4. Resources to install the operating system

Resource	Documentation links
iDRAC	<i>Integrated Dell Remote Access Controller User's Guide</i> at https://www.dell.com/idracmanuals or for system specific <i>Integrated Dell Remote Access Controller User's Guide</i> , go to https://www.dell.com/poweredgemanuals > Product Support page of your system > Documentation .  NOTE: To determine the most recent iDRAC release for your platform and for latest documentation version, see KB article at https://www.dell.com/support/article/sln308699 .
Lifecycle Controller	<i>Dell Lifecycle Controller User's Guide</i> at https://www.dell.com/idracmanuals or for system specific <i>Dell Lifecycle Controller User's Guide</i> , go to https://www.dell.com/poweredgemanuals > Product Support page of your system > Documentation . Dell recommends using Lifecycle Controller to install the OS, since all required drivers are installed on the system.  NOTE: To determine the most recent iDRAC release for your platform and for latest documentation version, see KB article at https://www.dell.com/support/article/sln308699 .
OpenManage Deployment Toolkit	www.dell.com/openmanagemanuals > OpenManage Deployment Toolkit

 **NOTE:** For more information about installation and how-to videos for operating systems supported on PowerEdge systems, see [Supported Operating Systems for Dell EMC PowerEdge systems](#).

Options to download firmware

You can download firmware from the Dell support site. For information about downloading firmware, see the [Downloading drivers and firmware](#) section.

You can also choose any one of the following options to download the firmware. For information about how to download the firmware, see the documentation links provided in the table below.

Table 5. Options to download firmware

Option	Documentation link
Using Integrated Dell Remote Access Controller Lifecycle Controller (iDRAC with LC)	www.dell.com/idracmanuals
Using Dell Repository Manager (DRM)	www.dell.com/openmanagemanuals > Repository Manager
Using Dell Server Update Utility (SUU)	www.dell.com/openmanagemanuals > Server Update Utility
Using Dell OpenManage Deployment Toolkit (DTK)	www.dell.com/openmanagemanuals > OpenManage Deployment Toolkit
Using iDRAC virtual media	www.dell.com/idracmanuals

Options to download and install OS drivers

You can choose any one of the following options to download and install OS drivers. For information about how to download or install OS drivers, see the documentation links provided in the table below.

Table 6. Options to download and install OS drivers

Option	Documentation
Dell EMC support site	Downloading drivers and firmware section.
iDRAC virtual media	<i>Integrated Dell Remote Access Controller User's Guide</i> at https://www.dell.com/idracmanuals or for system specific <i>Integrated Dell Remote Access Controller User's Guide</i> , go to https://www.dell.com/poweredgemanuals > Product Support page of your system > Documentation .  NOTE: To determine the most recent iDRAC release for your platform and for latest documentation version, see https://www.dell.com/support/article/sln308699 .

Downloading drivers and firmware

It is recommended that you download and install the latest BIOS, drivers, and systems management firmware on the system.

Prerequisites

Ensure that you clear the web browser cache before downloading the drivers and firmware.

Steps

1. Go to www.dell.com/support/drivers.
2. Enter the Service Tag of the system in the **Enter a Dell Service Tag, Dell EMC Product ID or Model** field, and then press Enter.
 **NOTE:** If you do not have the Service Tag, click **Browse all products**, and navigate to your product.
3. On the displayed product page, click **Drivers & Downloads**.
On the **Drivers & Downloads** page, all drivers that are applicable to the system are displayed.
4. Download the drivers to a USB drive, CD, or DVD.

Minimum to POST and system management configuration validation

This section describes the minimum to POST system requirement and system management configuration validation of the Dell EMC system.

Topics:

- [Minimum configuration to POST](#)
- [Configuration validation](#)

Minimum configuration to POST

The components listed below are the minimum configuration to POST:

- Processor
- One memory module (DIMM) in socket A1
- One power supply unit
- System board

Configuration validation

The new generation of PowerEdge systems have added interconnect flexibility and advanced iDRAC management features to collect precise system configuration information and report configuration errors.

When the system is powered on, information about installed cables, risers, backplanes, floating card (adapter PERC like BOSS), and processor is obtained from the CPLD and backplane memory maps is analyzed. This information forms a unique configuration, which is compared with one of the qualified configurations stored in a table maintained by iDRAC.

One or more sensors are assigned to each of the configuration elements. During POST, any configuration validation error is logged in the System Event Log (SEL)/LifeCycle (LC) log. The reported events are categorized in the configuration validation error table.

Table 7. Configuration validation error

Error	Description	Possible cause and recommendations	Example
Config Error	A configuration element within the closest match contains something that is unexpected and does not match any Dell qualified configuration.	Wrong configuration	Config Error: Backplane cable CTRS_SRC_SA1 and BP-DST_SA1
		The element reported in HWC8010 errors are assembled incorrectly. Verify element (cable, risers, etc) placement in the system.	Config Error : SL Cable PLANAR_SL7 and CTRL_DST_PA1
Config Missing	iDRAC found a configuration element missing within the closest match detected.	Missing or damaged cable, device, or part	Config Missing: adapter PERC/HBA
		Missing element or cable is reported in HWC8010 error logs. Install the	Config Missing : SL cable PLANAR_SL8 and CTRL_DST_PA1

Table 7. Configuration validation error (continued)

Error	Description	Possible cause and recommendations	Example
		missing element (cable, risers, etc).	
Comm Error	A configuration element is not responding to iDRAC using the management interface while running an inventory check.	System management sideband communication Unplug AC Power, reseal the element and replace the element if the problem persists.	Comm Error: Backplane 2

Error messages

This section describes the error messages displayed on the screen during POST or captured in the system event log (SEL)/ LifeCycle (LC) log.

Table 8. Error message HWC8010

Error code	HWC8010
Message	The System Configuration Check operation resulted in the following issue involving the indicated component type
Arguments	Riser, floating card (adapter PERClike BOSS), backplane, processor, cable, or other components
Detailed Description	The issue identified in the message is observed in the System Configuration Check operation.
Recommended Response Action	Do the following and retry the operation: <ol style="list-style-type: none"> 1. Disconnect the input power. 2. Check for proper cable connection and component placement. If the issue persists, contact the service provider.
Category	System Health (HWC = Hardware Config)
Severity	Critical
Trap/EventID	2329

Table 9. Error message HWC8011

Error code	HWC8011
Message	The System Configuration Check operation resulted in multiple issues involving the indicated component type
Arguments	Riser, floating card (adapter PERClike BOSS), backplane, processor, cable, or other components
Detailed Description	Multiple issues are observed in the System Configuration Check operation.
Recommended Response Action	Do the following and retry the operation: <ol style="list-style-type: none"> 1. Disconnect the input power. 2. Check for proper cable connection and component placement. If the issue persists, contact the service provider.
Category	System Health (HWC = Hardware Config)
Severity	Critical

Installing and removing system components

Topics:

- Safety instructions
- Before working inside your system
- After working inside your system
- Recommended tools
- Optional front bezel
- System cover
- Optional optical drive
- Air shroud
- Cooling fans
- Intrusion switch
- Drive backplane
- Drives
- Cable routing
- System memory
- Processor and heat sink
- Expansion cards and expansion card risers
- Optional IDSDM module
- MicroSD card
- Optional BOSS S1 card
- PERC
- System battery
- Optional internal USB card
- Power supply unit
- System board
- Trusted Platform Module
- Control panel

Safety instructions

 **CAUTION:** Ensure that two or more people lift the system horizontally from the box and place it on a flat surface, rack lift, or into the rails.

 **WARNING:** Opening or removing the system cover while the system is powered on may expose you to a risk of electric shock.

 **WARNING:** Do not operate the system without the cover for a duration exceeding five minutes. Operating the system without the system cover can result in component damage.

 **CAUTION:** Many repairs may only be done by a certified service technician. You should only perform troubleshooting and simple repairs as authorized in your product documentation, or as directed by the online or telephone service and support team. Damage due to servicing that is not authorized by Dell is not covered by your warranty. Read and follow the safety instructions that are shipped with your product.

 **NOTE:** It is recommended that you always use an antistatic mat and antistatic strap while working on components inside the system.

 **CAUTION:** To ensure proper operation and cooling, all system bays and fans must always be populated with a component or a blank.

NOTE: While replacing the hot swappable PSU, after next server boot; the new PSU automatically updates to the same firmware and configuration of the replaced one. For updating to the latest firmware and changing the configuration, see the *Lifecycle Controller User's Guide* at <https://www.dell.com/idracmanuals>.

NOTE: While replacing faulty storage controller, FC, or NIC card with the same type of card, after you power on the system; the new card automatically updates to the same firmware and configuration of the faulty one. For updating to the latest firmware and changing the configuration, see the *Lifecycle Controller User's Guide* at <https://www.dell.com/idracmanuals>.

CAUTION: Do not install GPUs, network cards, or other PCIe devices on your system that are not validated and tested by Dell. Damage caused by unauthorized and invalidated hardware installation will null and void the system warranty.

Before working inside your system

Prerequisites

Follow the safety guidelines listed in the [Safety instructions](#).

Steps

1. Power off the system and all attached peripherals.
2. Disconnect the system from the electrical outlet, and disconnect the peripherals.
3. If applicable, remove the system from the rack.
For more information, see the *Rail Installation Guide* relevant to your rail solutions at www.dell.com/poweredgemanuals.
4. Remove the system cover.

After working inside your system

Prerequisites

Follow the safety guidelines listed in [Safety instructions](#).

Steps

1. Replace the system cover.
2. If applicable, install the system into the rack.
For more information, see the *Rail Installation Guide* relevant to your system at www.dell.com/poweredgemanuals.
3. Reconnect the peripherals and connect the system to the electrical outlet, and then power on the system.

Recommended tools

You may need any or combination of the following tools to perform the removal and installation procedures:

- Key to the bezel lock. The key is required only if your system includes a bezel.
- Phillips 1 screwdriver
- Phillips 2 screwdriver
- Torx T15 screwdriver
- 5 mm hex nut screwdriver
- Plastic scribe
- 1/4-inch flat blade screwdriver
- Wrist grounding strap connected to the ground
- ESD mat
- Needle-nose pliers

Optional front bezel

Removing the front bezel

The procedure to remove the front bezel with and without the LCD panel is the same.

Prerequisites

1. Follow the safety guidelines listed in the [Safety instructions](#).
2. Keep the bezel key handy.
i NOTE: The bezel key is part of the LCD bezel package.

Steps

1. Unlock the front bezel.
2. Press the release button, and disengage the left end of the bezel.
3. Unhook the right end, and remove the bezel.



Figure 11. Removing the front bezel with the LCD panel

Next steps

[Replace the front bezel.](#)

Installing the front bezel

The procedure to install the front bezel with and without the LCD panel is the same.

Prerequisites

1. Follow the safety guidelines listed in the [Safety instructions](#).
2. Locate and remove the bezel key.

NOTE: The bezel key is part of the LCD bezel package.

Steps

1. Align and insert the tabs on the bezel into the slots on the system.
2. Press the bezel until the release button clicks in place.
3. Lock the front bezel.

Figure 12. Installing the front bezel



System cover

Removing the system cover

Prerequisites

1. Follow the safety guidelines listed in the [Safety instructions](#).
2. Power off the system, and any attached peripherals.
3. Disconnect the system from the electrical outlet and peripherals.

Steps

1. Using a 1/4-inch flat head or Phillips #2 screwdriver, rotate the lock counterclockwise to the unlock position.
2. Lift the release latch until the system cover slides back.
3. Lift the cover from the system.



Figure 13. Removing the system cover

Next steps

Replace the system cover.

Installing the system cover

Prerequisites

1. Follow the safety guidelines listed in the [Safety instructions](#).
2. Follow the procedure listed in [Before working inside your system](#).
3. Ensure that all internal cables are connected and routed properly, and no tools or extra parts are left inside the system.

Steps

1. Align the tabs on the system cover with the guide slots on the system.
2. Close the system cover release latch.
3. Using a 1/4-inch flat head or Phillips #2 screwdriver, rotate the lock clockwise to the lock position.



Figure 14. Installing the system cover

Next steps

Follow the procedure listed in [After working inside your system](#).

Optional optical drive

This is a service technician replaceable part only.

Removing the optical drive

Prerequisites

1. Follow the safety guidelines listed in the [Safety instructions](#).
2. Follow the procedure listed in the [Before working inside your system](#).
3. Disconnect the cables that are connected to the optical drive.

Steps

1. Press the tab to release the optical drive from the optical drive bay.
2. Slide the optical drive out of the system.

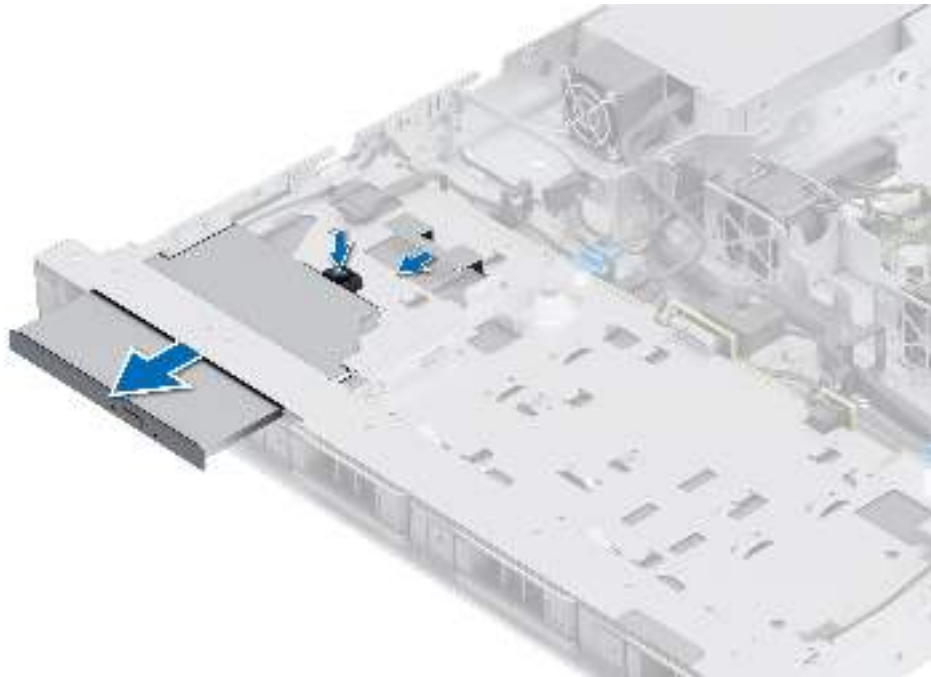

Figure 15. Removing the optical drive

Next steps

Replace the optical drive.

Installing the optical drive

Prerequisites

1. Follow the safety guidelines listed in the [Safety instructions](#).
2. Follow the procedure listed in the [Before working inside your system](#).

i **NOTE:** Ensure that you note the routing of the cables as you remove them from the system board. Route the cable properly when you replace it to prevent the cable from being pinched or crimped.

Steps

1. Align and slide the optical drive into the optical drive slot on the system until it latches.
2. Connect the power cable and signal cable to the optical drive.

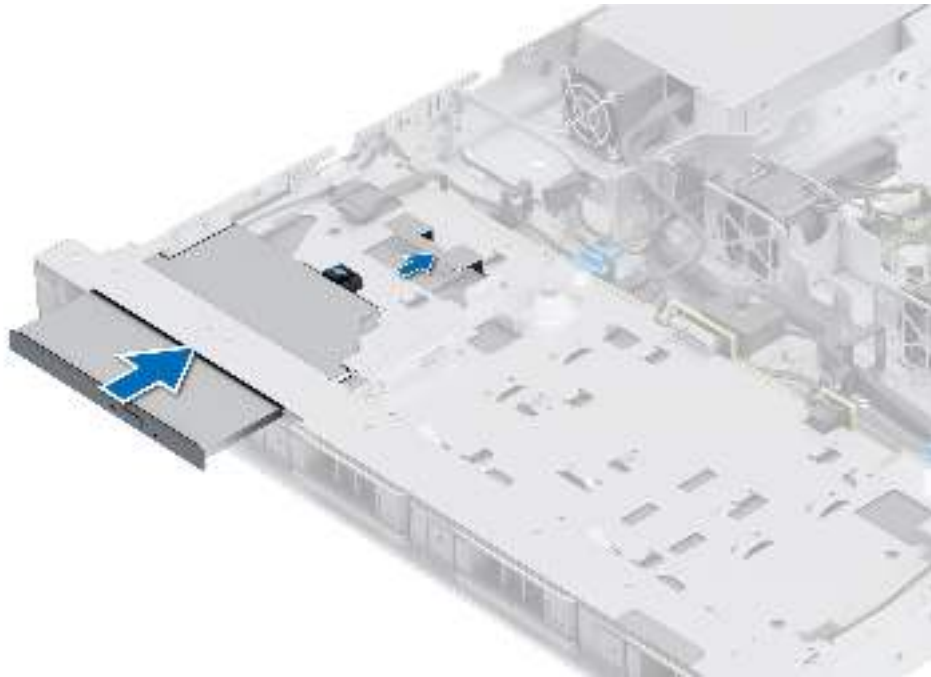

Figure 16. Installing the optical drive

Next steps

1. [Install the system cover.](#)
2. Follow the procedure listed in the [After working inside your system.](#)

Air shroud

Removing the air shroud

Prerequisites

CAUTION: Never operate your system with the air shroud removed. The system may get overheated quickly, resulting in shutdown of the system and loss of data.

1. Follow the safety guidelines listed in the [Safety instructions](#).
2. Follow the procedure listed in the [Before working inside your system](#).

Steps

Hold the air shroud at both ends and lift the air shroud out of the system.

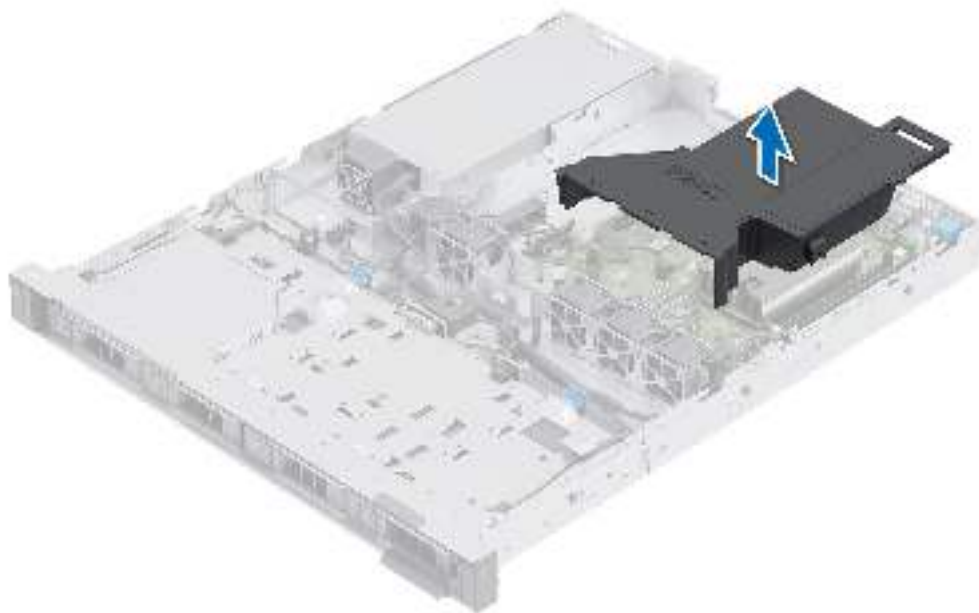

Figure 17. Removing the air shroud

Next steps

[Replace the air shroud.](#)

Installing the air shroud

Prerequisites

1. Follow the safety guidelines listed in the [Safety instructions](#).
2. Follow the procedure listed in the [Before working inside your system](#).

Steps

1. Align the slot on the air shroud with the standoff on the system.
2. Lower the air shroud into the system until it is firmly seated.

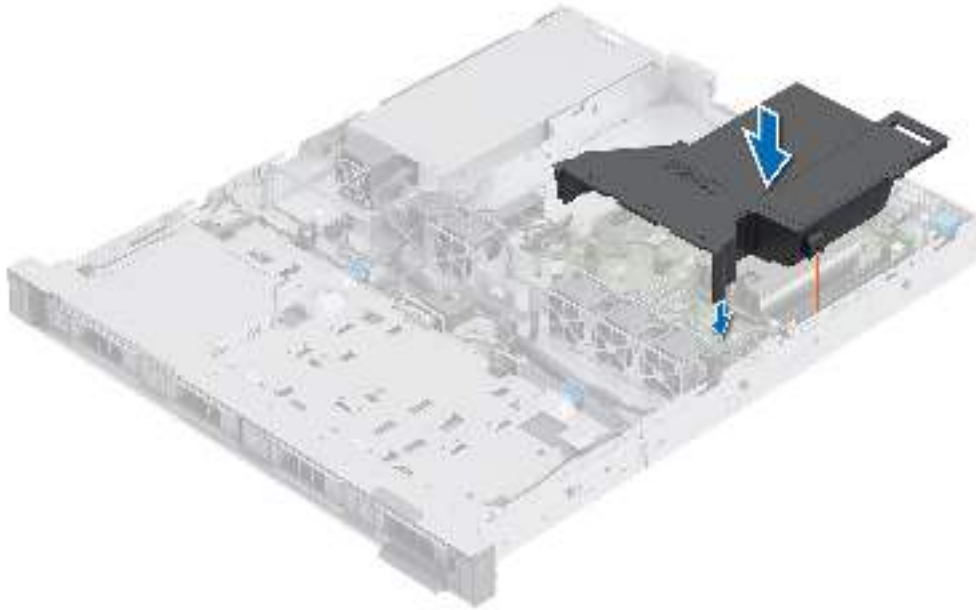

Figure 18. Installing the air shroud

Next steps

Follow the procedure listed in [After working inside your system.](#)

Cooling fans

Removing a cooling fan

Prerequisites

1. Follow the safety guidelines listed in the [Safety instructions.](#)
2. Follow the procedure listed in the [Before working inside your system.](#)
3. [Remove the air shroud.](#)

Steps

Remove the fan out of the system partially and then unplug the fan cable from the system board.

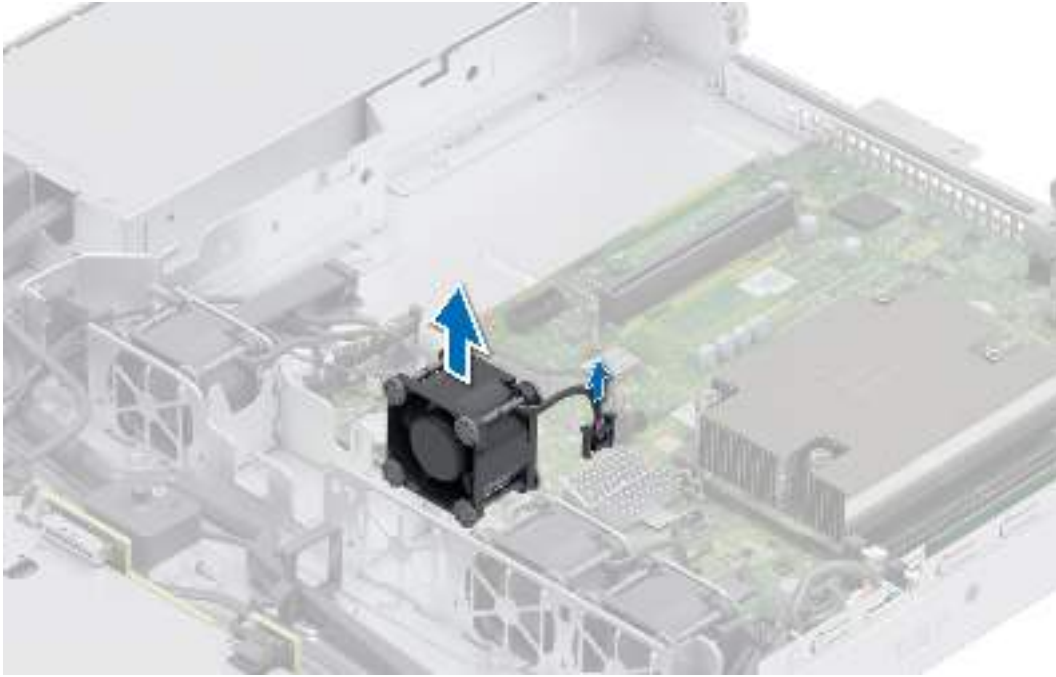

Figure 19. Removing a cooling fan

Next steps

Replace the cooling fan.

Installing a cooling fan

Prerequisites

1. Follow the safety guidelines listed in the [Safety instructions](#).
2. Follow the procedure listed in the [Before working inside your system](#).

Steps

Align and slide the cooling fan into the cooling fan cage and plug the fan cable to the system board.

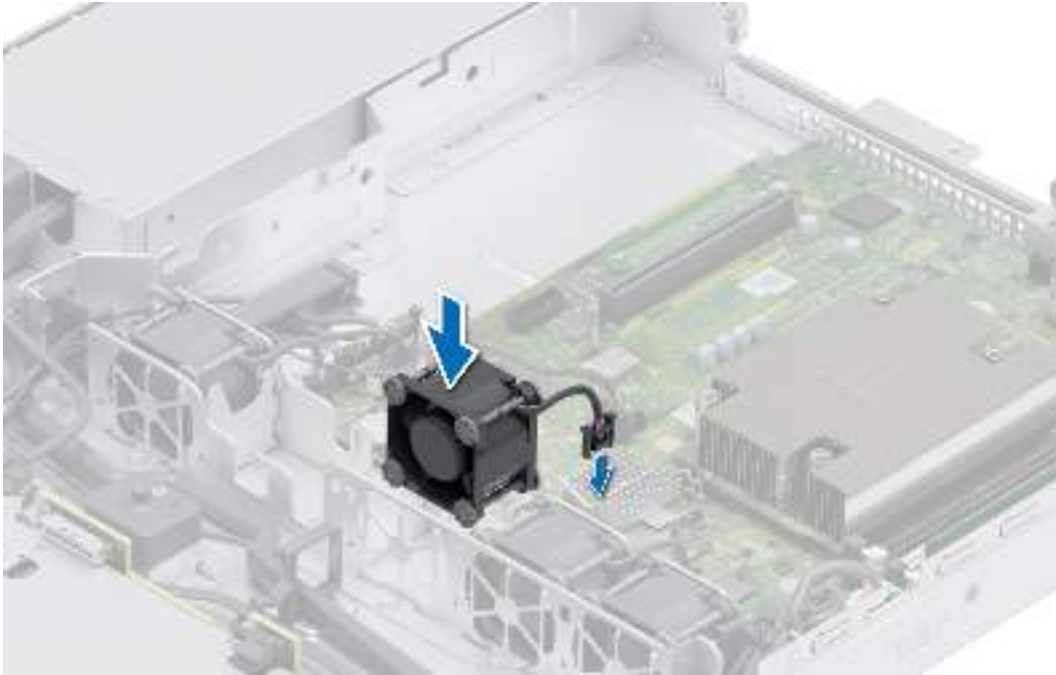

Figure 20. Installing a cooling fan

Next steps

1. [Install the air shroud.](#)
2. Follow the procedure listed in [After working inside your system.](#)

Intrusion switch

This is a service technician replaceable part only.

Removing the intrusion switch module

Prerequisites

1. Follow the safety guidelines listed in the [Safety instructions.](#)
2. Follow the procedure listed in the [Before working inside your system.](#)
3. [Remove the air shroud.](#)

Steps

1. Disconnect and remove the intrusion switch cable from the connector on the system board.
Observe the routing of the cable as you remove it from the system.
2. Using the Phillips #1 screwdriver, remove the screw securing the intrusion switch module.
3. Lift the intrusion switch module out of the system.



Figure 21. Removing the intrusion switch module

Next steps

Replace the intrusion switch module.

Installing the intrusion switch

Prerequisites

1. Follow the safety guidelines listed in the [Safety instructions](#).
2. Follow the procedure listed in [Before working inside your system](#).
3. [Remove the air shroud](#).

Steps

1. Align and insert the intrusion switch module into the slot on the system until firmly seated.
2. Using the Phillips #1 screwdriver, tighten the screw securing the intrusion switch module.
3. Connect the intrusion switch cable to the connector on the system board.

NOTE: Route the cable properly when you replace it to prevent the cable from being pinched or crimped.



Figure 22. Installing the intrusion switch

Next steps

1. [Install the air shroud.](#)
2. Follow the procedure listed in [After working inside your system.](#)

Drive backplane

This is a service technician replaceable part only.

Drive backplane

Depending on your system configuration, the drive backplanes supported for R250 system are listed here:

Table 10. Supported backplane options for R250 system

System	Supported hard drive options
PowerEdge R250	3.5-inch (x4) SAS, SATA backplane

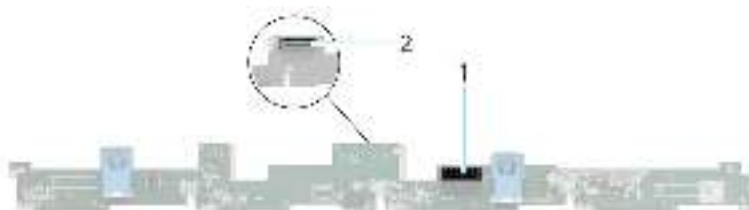

Figure 23. 4 x 3.5-inch drive backplane

1. BP_PWR_1 (backplane power and signal cable to PIB)
2. BP_DST_SA1 (SAS/SATA connector)

Removing the backplane

Prerequisites

CAUTION: To prevent damage to the drives and backplane, remove the drives from the system before removing the backplane.

CAUTION: Note the number of each drive and temporarily label them before you remove the drive so that you can reinstall them in the same location.

1. Follow the safety guidelines listed in the [Safety instructions](#).
2. Follow the procedure listed in the [Before working inside your system](#).
3. [Remove the air shroud](#).
4. Remove all the drives.
5. If installed, disconnect the optical drive signal and power cables from the system.
NOTE: Observe the routing of the cable as you remove it from the system.
6. Disconnect the drive backplane cables from the connectors on the system board.

Steps

1. Press the blue release tabs to disengage the drive backplane from the hooks on the system.
2. Lift the drive backplane out of the system.
NOTE: To avoid damaging the backplane, ensure that you move the control panel cables from the cable routing clips before removing the backplane.

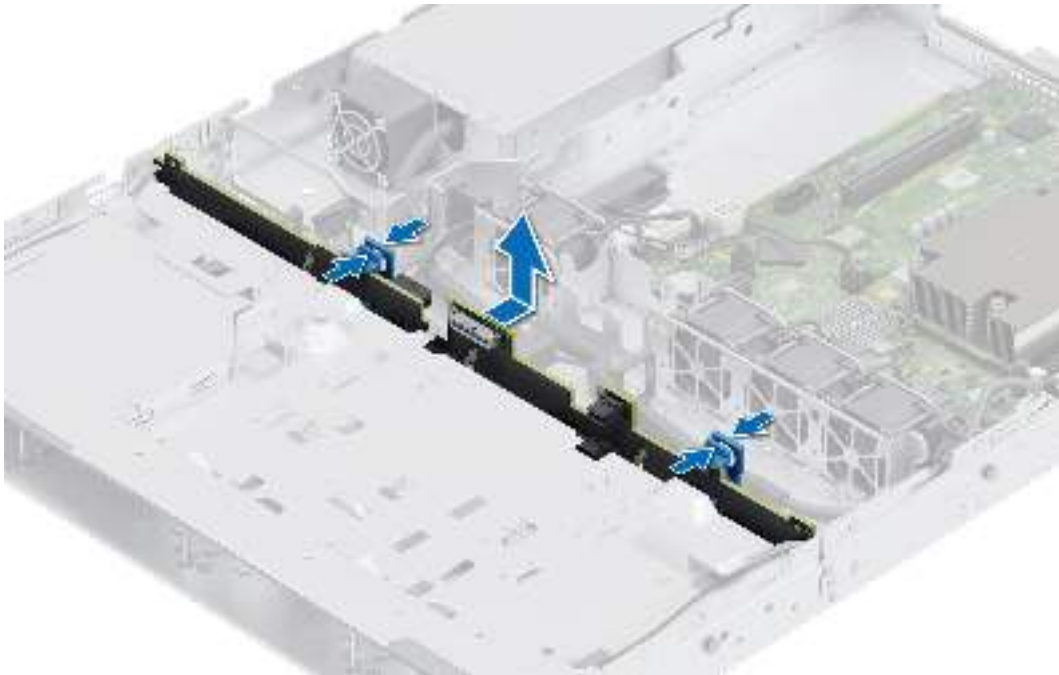

Figure 24. Removing the backplane

Next steps

[Replace the drive backplane.](#)

Installing the drive backplane

Prerequisites

1. Follow the safety guidelines listed in the [Safety instructions](#).

2. Follow the procedure listed in the [Before working inside your system](#).
3. [Remove the air shroud](#).
4. Remove all the drives.

i **NOTE:** To avoid damaging the backplane, ensure to move the control panel cables from the cable routing clips before removing the backplane.

i **NOTE:** Route the cable properly when you replace it to prevent the cable from being pinched or crimped.

Steps

1. Use the hooks on the system as guides to align the slots on the backplane with the guides on the system.
2. Insert the backplane into the guides and lower the backplane until the blue release tabs click into place.

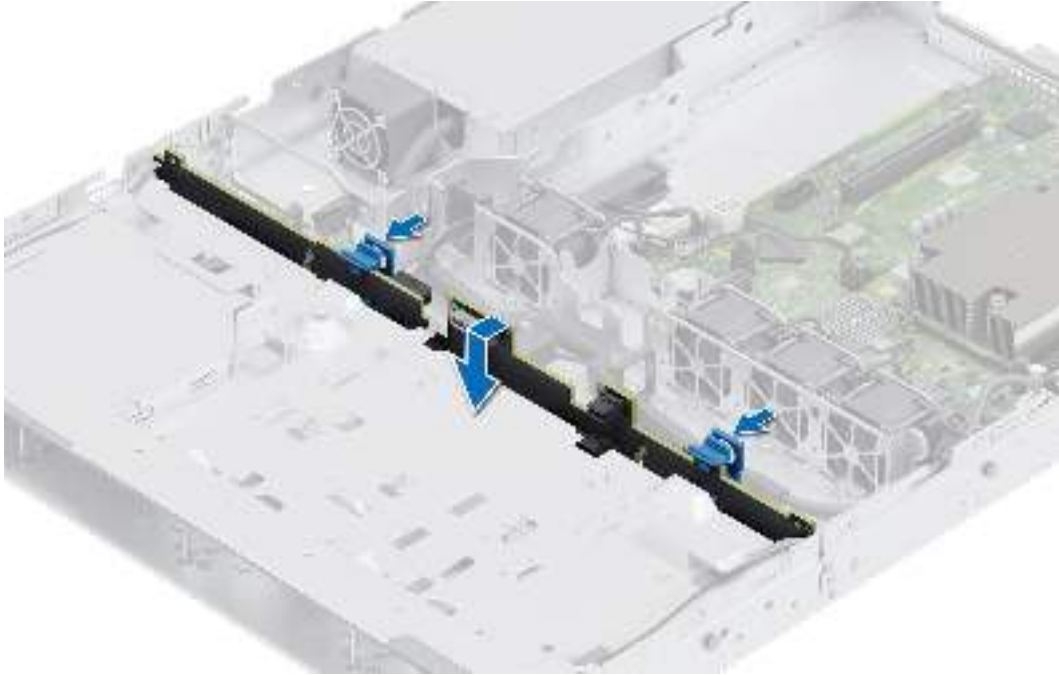

Figure 25. Installing the drive backplane

Next steps

1. Reconnect all the disconnected cables to the backplane.
2. Install all the drives.
3. [Install the air shroud](#).
4. Follow the procedure listed in [After working inside your system](#).

Drives

Removing a drive blank

Prerequisites

1. Follow the safety guidelines listed in the [Safety instructions](#).
2. If installed, [remove the front bezel](#).

⚠ CAUTION: To maintain proper system cooling, drive blanks must be installed in all empty drive slots.

Steps

Press the release button, and slide the drive blank out of the drive slot.



Figure 26. Removing a drive blank

Next steps

Installing a drive or replace the drive blank.

Installing a drive blank

Prerequisites

1. Follow the safety guidelines listed in the [Safety instructions](#).
2. If installed, [remove the front bezel](#).

Steps

Insert the drive blank into the drive slot until the release button clicks into place.



Figure 27. Installing a drive blank

Next steps

If removed, [install the front bezel](#).

Removing a cabled drive

Prerequisites

1. Follow the safety guidelines listed in the [Safety instructions](#).
2. Follow the procedure listed in the [Before working inside your system](#).

CAUTION: Mixing drives from previous generations of PowerEdge servers is not supported.

Steps

1. Disconnect the power and data cable connector that is connected to the drive.
2. Press the release button, and slide the drive out of the drive slot.

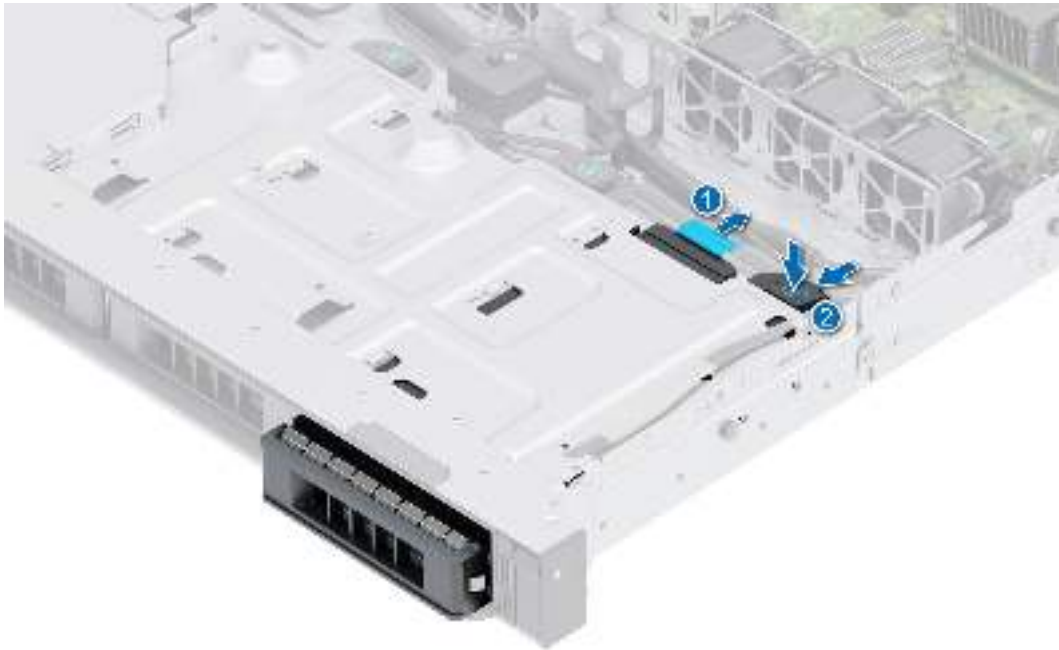

Figure 28. Removing the cabled drive

Next steps

Replace the cabled drive.

Installing a cabled drive

Prerequisites

1. Follow the safety guidelines listed in the [Safety instructions](#).
2. Follow the procedure listed in the [Before working inside your system](#).

CAUTION: Mixing drive carriers from other generations of PowerEdge servers is not supported.

NOTE: When installing a drive into the drive carrier, ensure that the screws are torqued to 4 inch-pounds.

Steps

1. Insert the drive into the drive slot until the release button clicks into place.
2. Connect the power and data cable connector to the drive.



Figure 29. Installing the cabled drive

Next steps

Follow the procedure listed in [After working inside your system](#).

Removing the drive carrier

Prerequisites

1. Follow the safety guidelines listed in the [Safety instructions](#).
2. If installed, [remove the front bezel](#).
3. Using the management software, prepare the drive for removal.

If the drive is online, the green activity or fault indicator blinks while the drive is powering off. When the drive indicators are off, the drive is ready for removal. For more information, see the documentation for the storage controller.

CAUTION: Before attempting to remove or install a drive while the system is running, see the documentation for the storage controller card to ensure that the host adapter is configured correctly to support drive removal and insertion.

CAUTION: To prevent data loss, ensure that your operating system supports drive installation. See the documentation supplied with your operating system.

Steps

1. Press the release button to open the drive carrier release handle.
2. Holding the drive carrier release handle, slide the drive carrier out of the drive slot.



Figure 30. Removing a drive carrier

Next steps

Install a [drive carrier](#) or [drive blank](#).

Installing the drive carrier

Prerequisites

- CAUTION:** Before removing or installing a drive while the system is running, see the documentation for the storage controller card to ensure that the host adapter is configured correctly to support drive removal and insertion.
- CAUTION:** Combining SAS and SATA drives in the same RAID volume is not supported.
- CAUTION:** When installing a drive, ensure that the adjacent drives are fully installed. Inserting a drive carrier and attempting to lock its handle next to a partially installed carrier can damage the partially installed carrier's shield spring and make it unusable.
- CAUTION:** To prevent data loss, ensure that your operating system supports hot-swap drive installation. See the documentation supplied with your operating system.
- CAUTION:** When a replacement hot swappable drive is installed and the system is powered on, the drive automatically begins to rebuild. Ensure that the replacement drive is blank or contains data that you wish to overwrite. Any data on the replacement drive is immediately lost after the drive is installed.

NOTE: Ensure the release handle on the drive carrier is in the open position before inserting the carrier into the slot.

1. Follow the safety guidelines listed in the [Safety instructions](#).
2. If installed, [remove the front bezel](#).
3. Remove the drive carrier or remove the drive blank when you want to assemble the drives in to the system.

Steps

1. Slide the drive carrier into the drive slot.
2. Close the drive carrier release handle to lock the drive in place.



Figure 31. Installing a drive carrier

Next steps

If removed, [install the front bezel](#).

Removing the drive from the drive carrier

Prerequisites

1. Follow the safety guidelines listed in the [Safety instructions](#).

Steps

1. Using a Phillips #1 screwdriver, remove the screws from the slide rails on the drive carrier.

NOTE: If the drive or SSD carrier has Torx screw , use Torx 6 (for 2.5-inch drive) or Torx 8 (for 3.5-inch drive) screwdriver to remove the drive.

2. Lift the drive out of the drive carrier.



Figure 32. Removing the drive from the drive carrier

Next steps

Install the drive into the drive carrier.

Installing the drive into the drive carrier

Prerequisites

1. Follow the safety guidelines listed in the [Safety instructions](#).

NOTE: When installing a drive into the drive carrier, ensure that the screws are torqued to 4 in-lbs.

Steps

1. Insert the drive into the drive carrier with the drive connector facing towards the rear of the carrier.
2. Align the screw holes on the drive with the screws holes on the drive carrier.
3. Using a Phillips #1 screwdriver, secure the drive to the drive carrier with the screws.

NOTE: If the drive or SSD carrier has Torx screw , use Torx 6 (for 2.5-inch drive) or Torx 8 (for 3.5-inch drive) screwdriver to install the drive.



Figure 33. Installing a drive into the drive carrier

Next steps

1. Install the drive carrier.

Cable routing

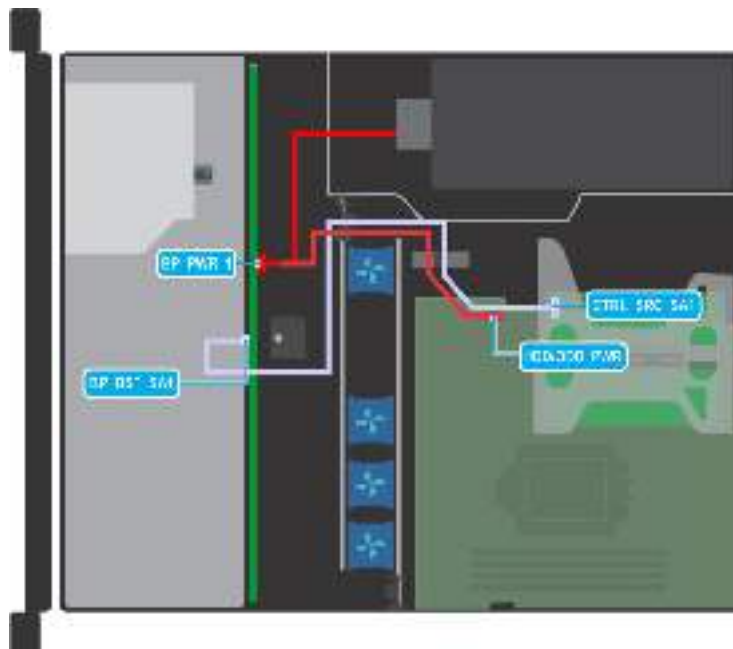

Figure 34. Cable routing - 4 x 3.5-inch backplane configuration with PERC adapter

Table 11. Cable routing - 4 x 3.5-inch backplane configuration with PERC adapter

From	To
BP_PWR_1 (Power connector on backplane)	HDD/ODD_PWR (PIB connector on the system board)
CTRL_SRC_SA1 (Signal connector on the PERC)	BP_DST_SA1 (Signal connector on backplane)

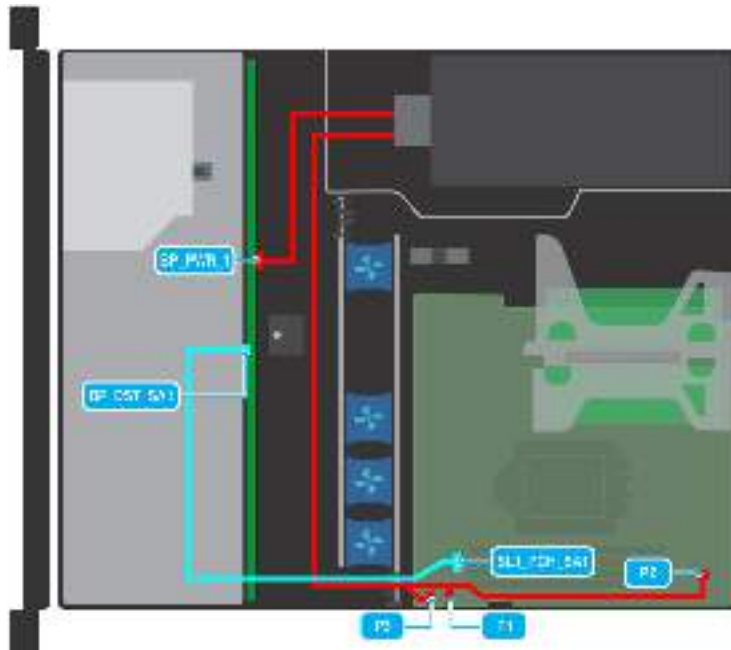

Figure 35. Cable routing for 4 x 3.5-inch backplane configuration with onboard SATA and PSU (Bronze)

Table 12. Cable routing - 4 x 3.5-inch backplane configuration with onboard SATA and PSU (Bronze)

From	To
BP_DST_SA1 (Signal connector on backplane)	SL1_PCH_SA1 (Signal connector on system board)
BP_PWR_1 (Power connector on backplane)	Cabled power supply
P1 (Power connector 1)	Cabled power supply
P2 (Power connector 2)	Cabled power supply
P3 (Power connector 3)	Cabled power supply

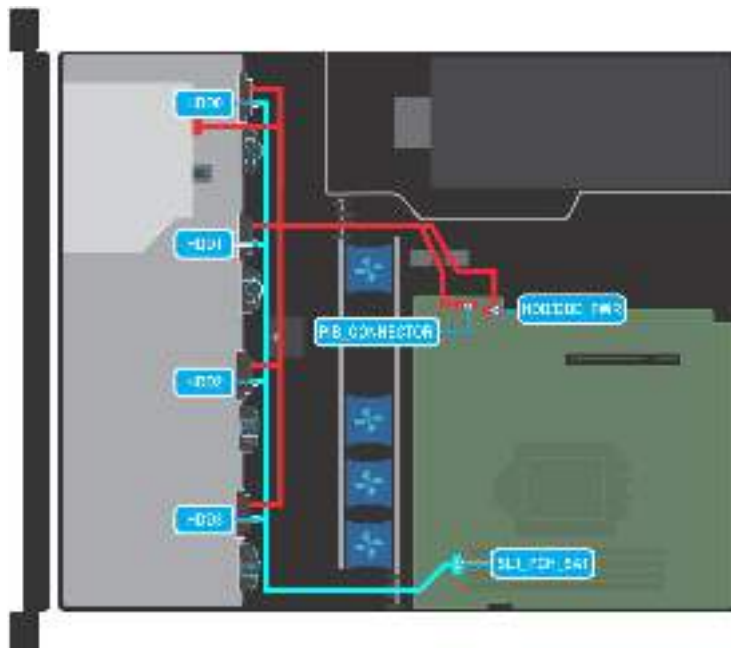

Figure 36. Cable routing - 4 x 3.5-inch cabled drive configuration

Table 13. Cable routing - 4 x 3.5-inch cabled drive configuration

From	To
HDD0 (HDD0 signal connector)	SL1_PCH_SA1 (Signal connector on system board)
HDD1 (HDD1 signal connector)	SL1_PCH_SA1 (Signal connector on system board)
HDD2 (HDD2 signal connector)	SL1_PCH_SA1 (Signal connector on system board)
HDD3 (HDD3 signal connector)	SL1_PCH_SA1 (Signal connector on system board)
Power connector on HDD0, HDD1, HDD2, and HDD 3	PIB_CONNECTOR (PIB connector on system board)
ODD (Optical Disk Drive) connector	HDD/ODD_PWR (HDD/ODD power connector on system board)

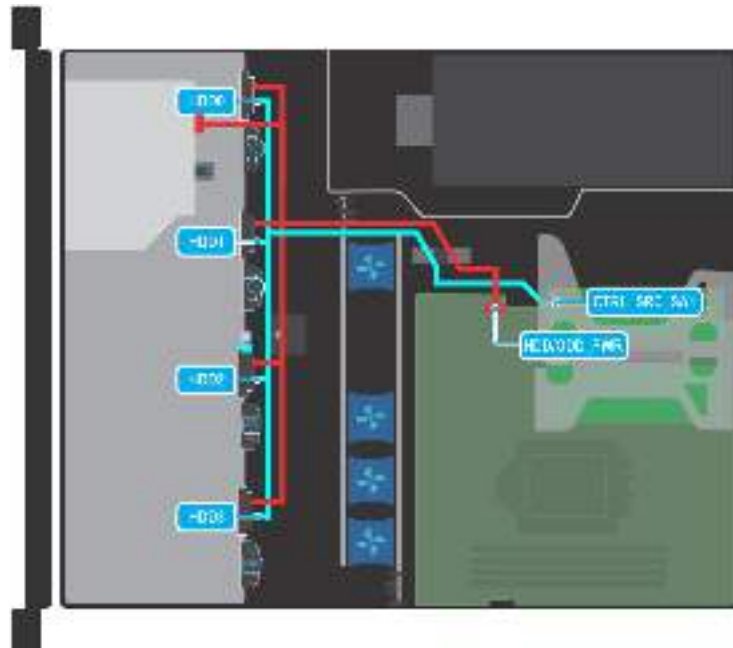

Figure 37. Cable routing - 4 x 3.5-inch cable drive configuration with PERC

Table 14. Cable routing - 4 x 3.5inch cable drive configuration with PERC

From	To
HDD0 (HDD0 signal connector)	CTRL_SRC_SA1 (Signal connector on the PERC)
HDD1 (HDD1 signal connector)	CTRL_SRC_SA1 (Signal connector on the PERC)
HDD2 (HDD2 signal connector)	CTRL_SRC_SA1 (Signal connector on the PERC)
HDD3 (HDD3 signal connector)	CTRL_SRC_SA1 (Signal connector on the PERC)
Power connector on HDD0, HDD1, HDD2, and HDD 3	HDD/ODD_PWR (HDD/ODD power connector on system board)
ODD (Optical Disk Drive) connector	HDD/ODD_PWR (HDD/ODD power connector on system board)

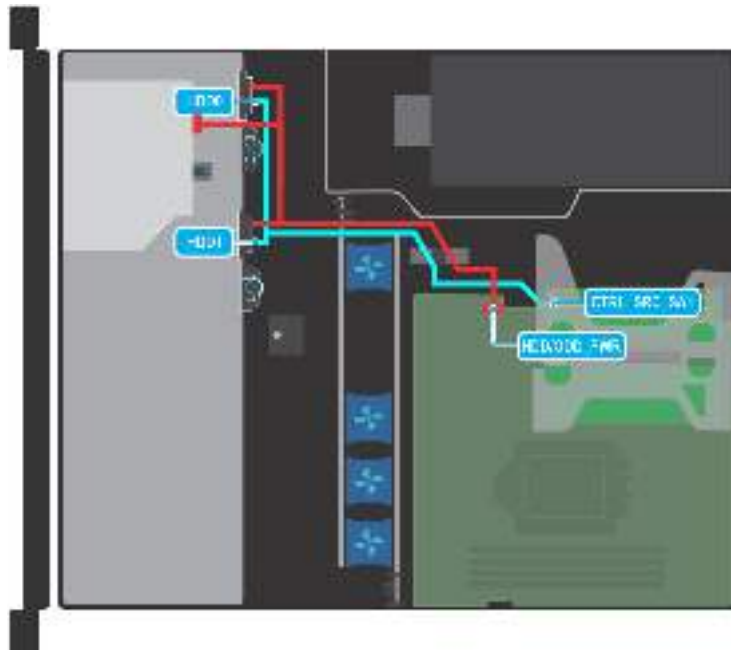

Figure 38. Cable routing - 2 x 3.5-inch cable drive configuration with PERC

Table 15. Cable routing - 2 x 3.5-inch cable drive configuration with PERC

From	To
HDD0 (HDD0 signal connector)	CTRL_SRC_SA1 (Signal connector on the PERC)
HDD1 (HDD1 signal connector)	CTRL_SRC_SA1 (Signal connector on the PERC)
Power connector on HDD0 and HDD1	HDD/ODD_PWR (HDD/ODD power connector on system board)
ODD (Optical Disk Drive) connector	HDD/ODD_PWR (HDD/ODD power connector on system board)

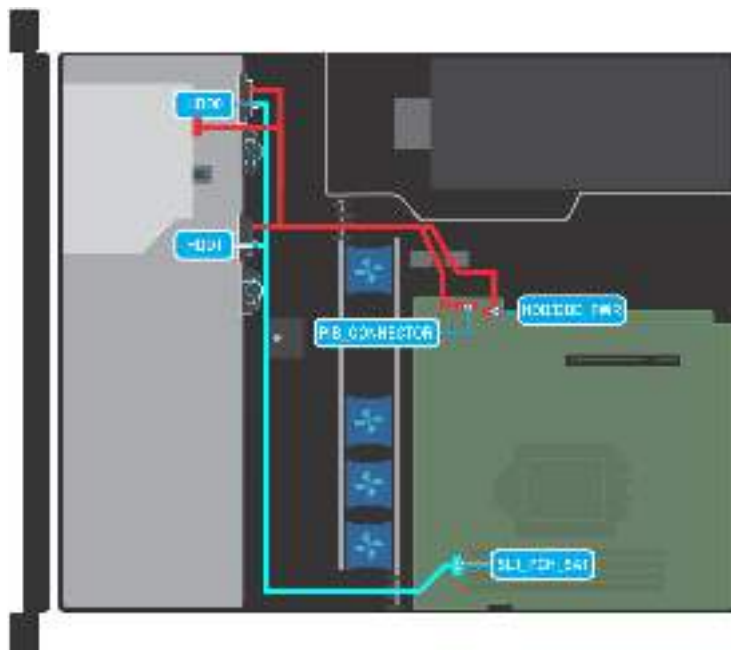

Figure 39. Cable routing - 2 x 3.5-inch cable drive configuration with SATA connection

Table 16. Cable routing - 2 x 3.5-inch cable drive configuration with SATA connection

From	To
HDD0 (HDD0 signal connector)	SL1_PCH_SA1 (Signal connector on system board)
HDD1 (HDD1 signal connector)	SL1_PCH_SA1 (Signal connector on system board)
Power connector on HDD0 and HDD1	PIB_CONNECTOR (PIB connector on system board)
ODD (Optical Disk Drive) connector	HDD/ODD_PWR (HDD/ODD power connector on system board)

System memory

System memory guidelines

The PowerEdge R250 system supports DDR4 unregistered DIMMs (UDIMMs). System memory holds the instructions that are executed by the processor.

Your system contains four memory sockets that are organized into two channels. In each channel, the first socket is marked white and the second socket black.

Memory channels are organized as follows:

Table 17. Memory channels

Channel 0	Channel 1
A1 and A3	A2 and A4



Figure 40. Memory socket location

Table 18. Supported memory matrix

DIMM type	Rank	Capacity	DIMM rated voltage and speed	DIMMs per Channel (DPC)
UDIMM	1R	8 GB /16 GB	DDR4 (1.2 V), 3200 MT/s	3200 MT/s
	2R	32 GB	DDR4 (1.2 V), 3200 MT/s	3200 MT/s

General memory module installation guidelines

To ensure optimal performance of your system, observe the following general guidelines when configuring your system memory. If your system's memory configurations fail to observe these guidelines, your system might not boot, stop responding during memory configuration, or operate with reduced memory.

The memory bus may operate at speeds up to 2933 MT/s depending on the following factors:

- System profile selected (for example, Performance Optimized, or Custom [can be run at high speed or lower])
- Maximum supported DIMM speed of the processor
- Maximum supported speed of the DIMMs
- Rank of the DIMMs

 **NOTE:** MT/s indicates DIMM speed in Mega-Transfers per second.

The system supports Flexible Memory Configuration, enabling the system to be configured and run in any valid chipset architectural configuration. The following are the recommended guidelines for installing memory modules:

- All DIMMs must be DDR4.
- If memory modules with different speeds are installed, they operate at the speed of the slowest installed memory module.
- Populate memory module sockets only if a processor is installed.
 - For single-processor systems, sockets A1 to A4 is available.
- In **Optimizer Mode**, the DRAM controllers operate independently in the 64-bit mode and provide optimized memory performance.

 **NOTE:** DIMM speed is limited to 2933 MT/s when mixing dual rank DIMMs with single rank or dual rank DIMMs in the same channel.

Table 19. Memory population rules

Processor	Configuration	Memory population	Memory population information
Single processor	Optimizer (Independent channel) population order	A{1}, A{2}, A{3}, A{4}	1, 2, 3, 4 DIMMs are allowed.

- Populate all the sockets with white release tabs first, followed by the black release tabs.
- Unbalanced or odd memory configuration results in a performance loss and system may not identify the memory modules being installed, so always populate memory channels identically with equal DIMMs for best performance.

Removing a memory module

Prerequisites

1. Follow the safety guidelines listed in the [Safety instructions](#).
2. Follow the procedure listed in the [Before working inside your system](#).
3. [Remove the air shroud](#).

 **WARNING:** The memory modules are hot to touch for some time after the system has been powered off. Allow the memory modules to cool before handling them.

Steps

1. Locate the appropriate memory module socket.
2. To release the memory module from the socket, simultaneously press the ejectors on both ends of the memory module socket to fully open.

CAUTION: Handle each memory module only by the card edges, ensuring not to touch the middle of the memory module or metallic contacts.

3. Lift the memory module away from the system.

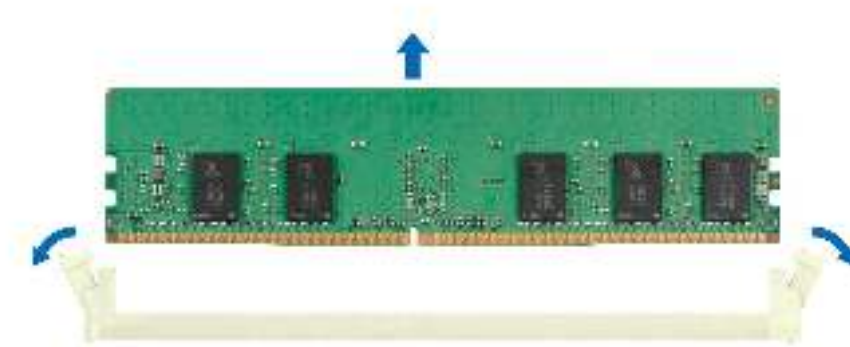

Figure 41. Removing a memory module

Next steps

Replace the memory module.

Installing a memory module

Prerequisites

1. Follow the safety guidelines listed in the [Safety instructions](#).
2. Follow the procedure listed in the [Before working inside your system](#).
3. [Remove the air shroud](#).

Steps

1. Locate the appropriate memory module socket.

CAUTION: Handle each memory module only by the card edges, ensuring not to touch the middle of the memory module or metallic contacts.

2. If a memory module blank is installed in the socket, remove it.

NOTE: Ensure the socket ejector latches are fully open, before installing the memory module.

3. Align the edge connector of the memory module with the alignment key of the memory module socket, and insert the memory module in the socket.

CAUTION: To prevent damage to the memory module or the memory module socket during installation, do not bend or flex the memory module; insert both ends of the memory module simultaneously.

NOTE: The memory module socket has an alignment key that enables you to install the memory module in the socket in only one orientation.

CAUTION: Do not apply pressure at the center of the memory module; apply pressure at both ends of the memory module evenly.

4. Press the memory module with your thumbs until the ejectors firmly click into place. When the memory module is properly seated in the socket, the levers on the memory module socket align with the levers on the other sockets that have memory modules installed.

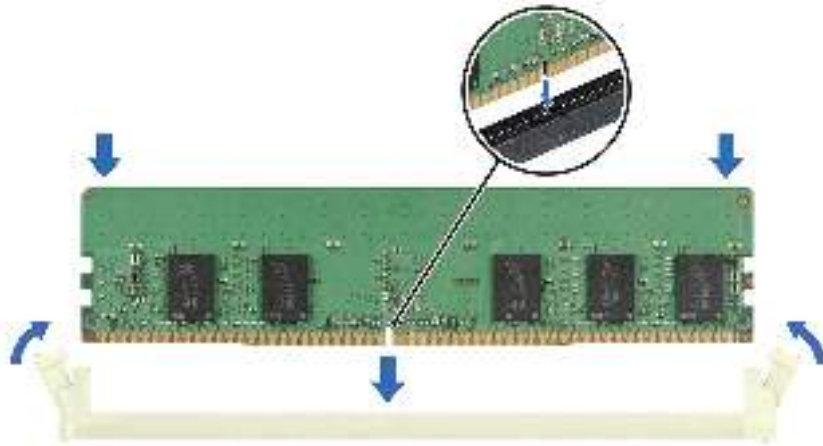

Figure 42. Installing a memory module

Next steps

1. [Install the air shroud.](#)
2. Follow the procedure listed in [After working inside the system.](#)
3. To verify if the memory module has been installed properly, press F2 and navigate to **System Setup Main Menu > System BIOS > Memory Settings**. In the **Memory Settings** screen, the System Memory Size must reflect the updated capacity of the installed memory.
4. If the System Memory Size is incorrect, one or more of the memory modules may not be installed properly. Ensure that the memory modules are firmly seated in their sockets.
5. Run the system memory test in system diagnostics.

Processor and heat sink

This is a service technician replaceable part only.

Removing the heat sink

Prerequisites

1. Follow the safety guidelines listed in the [Safety instructions](#).
2. Follow the procedure listed in the [Before working inside your system](#).
3. [Remove the air shroud.](#)

NOTE: The heat sink and processor are too hot to touch for some time after the system has been powered down. Allow the heat sink and processor to cool down before handling them.

Steps

1. Using a Philips #2 screwdriver, loosen the screws on the heat sink in the order that is mentioned below:
 - a. Loosen the first screw three turns.
 - b. Loosen the screw diagonally opposite to the screw you loosened first.
 - c. Return to the first screw and loosen it completely.

- d. Repeat the procedure for the remaining two screws.
2. . Lift the heat sink away from the system.

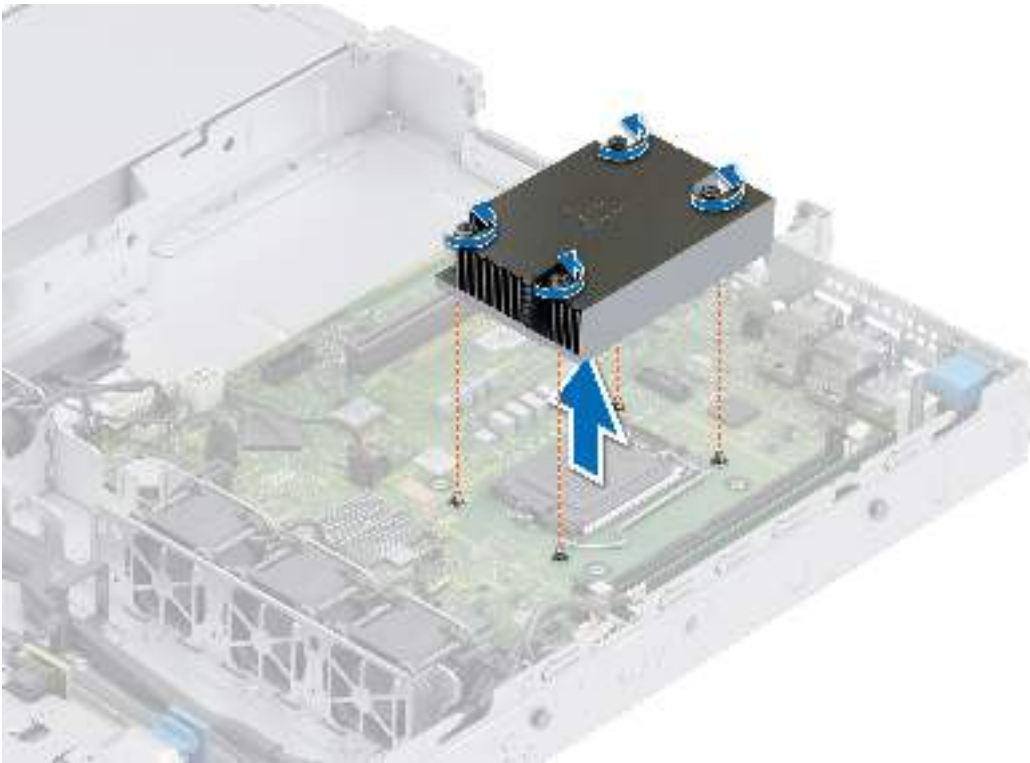

Figure 43. Removing a heat sink

Next steps

If you are removing a faulty heat sink, [replace the heat sink](#), if not, [remove the processor](#).

Removing the processor

Prerequisites

⚠ WARNING: The processor will be hot to touch for some time after the system has been powered off. Allow the processor to cool before removing it.

⚠ CAUTION: The processor is held in its socket under strong pressure. If the release lever is not held firmly, it can spring up suddenly.

ℹ NOTE: Remove the processor only if you are replacing the processor or the system board. This step is not required when replacing a heat sink module.

1. Follow the safety guidelines listed in the [Safety instructions](#).
2. Follow the procedure listed in [Before working inside your system](#).
3. [Remove the heat sink module](#).

Steps

1. Release the socket lever by pushing the lever down and out from under the tab on the processor shield.
2. Lift the lever upward until the processor shield lifts.

⚠ CAUTION: The processor socket pins are fragile and can be permanently damaged. Be careful not to bend the pins in the processor socket when removing the processor out of the socket.

3. Lift the processor out of the socket.

NOTE: Ensure that the processor and the bracket are placed in the tray after you remove the heat sink.



Figure 44. Removing the processor

Next steps

Replace the processor.

Installing the processor

Prerequisites

CAUTION: Never remove the heat sink from a processor unless you intend to replace the processor. The heat sink is necessary to maintain proper thermal conditions.

1. Follow the safety guidelines listed in the [Safety instructions](#).
2. Follow the procedure listed in [Before working inside your system](#).
3. [Remove the processor](#).

Steps

1. Align the pin 1 indicator of the processor with the triangle on the socket and place the processor on the socket.

CAUTION: Positioning the processor incorrectly can permanently damage the system board or the processor. Be careful not to bend the pins in the socket.

2. Lower the socket lever and push it under the tab to lock it.

NOTE: If the processor has previously been used in a system, remove any remaining thermal grease from the processor by using a lint-free cloth.



Figure 45. Installing the processor

Next steps

i **NOTE:** Ensure that you install the heat sink after you install the processor. The heat sink is necessary to maintain proper thermal conditions.

1. Install the heat sink module.
2. Follow the procedure listed in [After working inside your system](#).

Installing the heat sink

Prerequisites

△ **CAUTION:** Never remove the heat sink from a processor unless you intend to replace the processor. The heat sink is necessary to maintain proper thermal conditions.

1. Follow the safety guidelines listed in the [Safety instructions](#).
2. Follow the procedure listed in [Before working inside your system](#).
3. If removed, [install the processor](#).

Steps

1. If you are using an existing heat sink, remove the thermal grease from the heat sink by using a clean lint-free cloth.
2. Use the thermal grease syringe included with your processor kit to apply the grease in a quadrilateral design on the top of the processor.

△ **CAUTION:** Applying too much thermal grease can result in excess grease coming in contact with and contaminating the processor socket.

i **NOTE:** The thermal grease syringe is intended for single use only. Dispose the syringe after you use it.



Figure 46. Applying thermal grease on top of the processor

3. Place the heat sink onto the processor with the cable end facing the drive carrier.
4. Using the Phillips #2 screwdriver, tighten the screws on the heat sink in the order below:
 - a. Tighten the first screw completely.
 - b. Tighten the screw diagonally opposite to the screw you tighten first.
 - c. Repeat the procedure for the remaining two screws.

i **NOTE:** The processor and heat sink module retention screws should not be tightened to more than 0.13 kgf-m (1.35 N.m or 12 in-lbf).

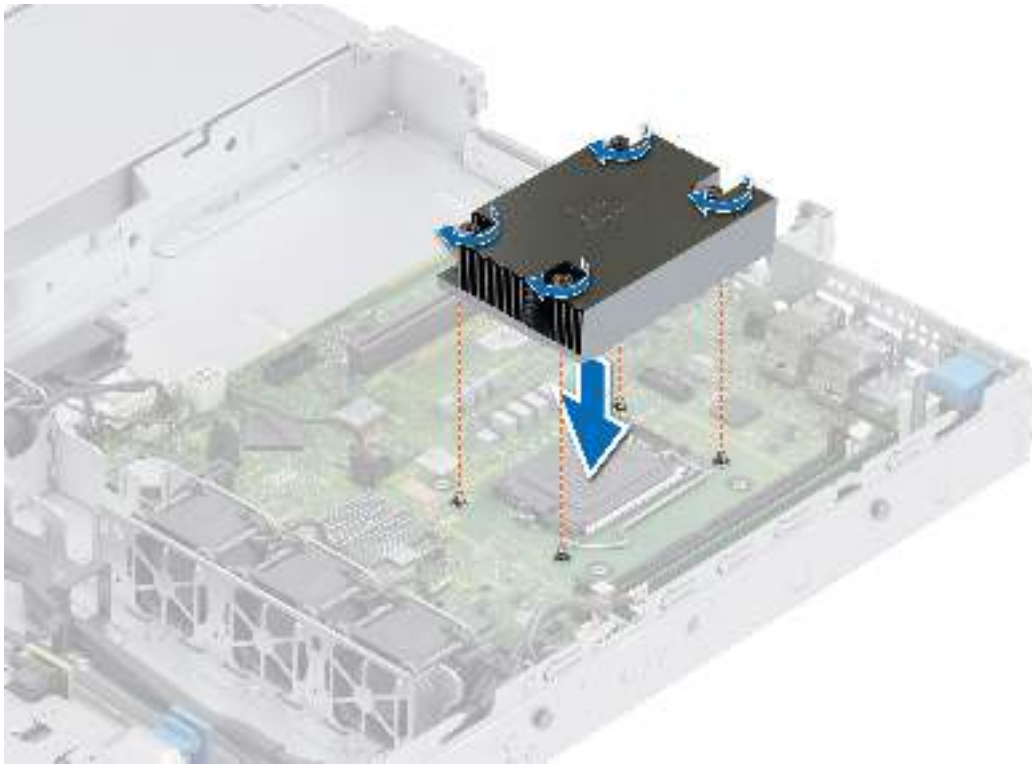

Figure 47. Installing the heat sink

Next steps

1. Follow the procedure listed in [After working inside your system](#).
2. While booting, press F2 to enter System Setup and check that the processor information matches the new system configuration.
3. Run the system diagnostics to verify that the new processor operates correctly.

Expansion cards and expansion card risers

NOTE: When an expansion card is not supported or missing, riser the iDRAC and Lifecycle Controller logs an event. This does not prevent your system from booting. However, if a F1/F2 pause occurs with an error message, see *Troubleshooting expansion cards* section in the *Dell EMC PowerEdge Servers Troubleshooting Guide* at www.dell.com/poweredgemanuals.

Expansion card installation guidelines



Figure 48. Expansion card slot connectors

1. Butterfly riser connector

The following table describes the expansion card riser configurations:

Table 20. Expansion card riser configurations

Configurations	Expansion card risers	PCIe Slots	Controlling processor	Height	Length	Slot width	Power
Config 0	Butterfly riser	1	Processor 1	Half height	Half length	x8	25 W
		2	Processor 1	Half height	Half length	x16	25 W
Config 1	No riser	N/a	N/a	N/a	N/a	N/a	N/a

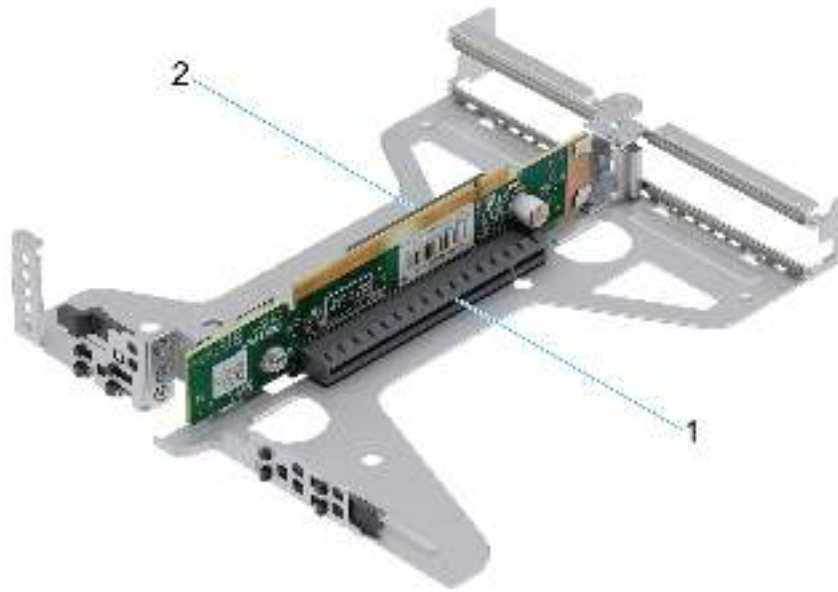

Figure 49. Butterfly riser

1. Slot 2
2. Slot 1

NOTE: The expansion-card slots are not hot-swappable.

For a proper mechanical fit and proper cooling of expansion cards, follow the guidelines in the following table. The expansion cards with the highest priority should be installed first using the slot priority indicated. All the other expansion cards should be installed in the card priority and slot priority order.

Table 21. Configuration 0: Butterfly riser

Card type	Slot priority	Maximum number of cards
Internal PERC adapter	2	1
Dell External Adapter	1, 2	2
Broadcom (NIC: 1Gb)	1, 2	2
Intel (NIC: 1Gb)	1, 2	2
Dell BOSS S1 Module	1, 2	2

NOTE: No expansion cards are supported in the "no riser" configuration.

Removing the expansion card risers

Prerequisites

1. Follow the safety guidelines listed in the [Safety instructions](#).
2. Follow the procedure listed in the [Before working inside your system](#).
3. [Remove the air shroud](#).

Steps

1. Open the blue expansion card riser retention-latch located on the system.
2. Holding the blue touch points, lift the expansion card riser out of the system.
3. If you are not replacing the expansion card, install a filler bracket and close the card retention latch.

Figure 50. Removing an expansion card

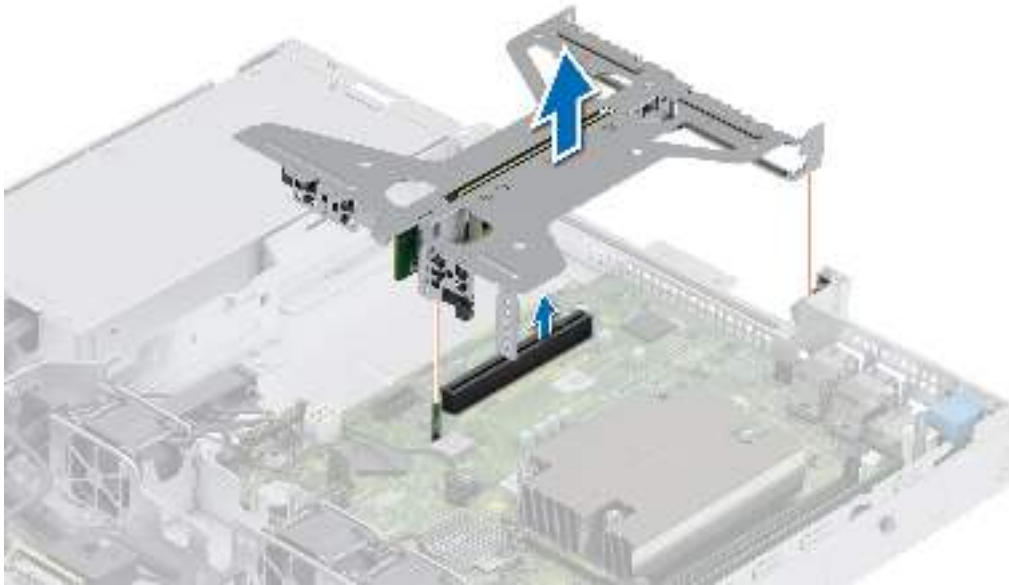

i NOTE: You must install a filler bracket over an empty expansion card slot to maintain Federal Communications Commission (FCC) certification of the system. The brackets also keep dust and dirt out of the system and aid in proper cooling and airflow inside the system.

i NOTE: The numbers on the image do not depict the exact steps. The numbers are for representation of sequence.

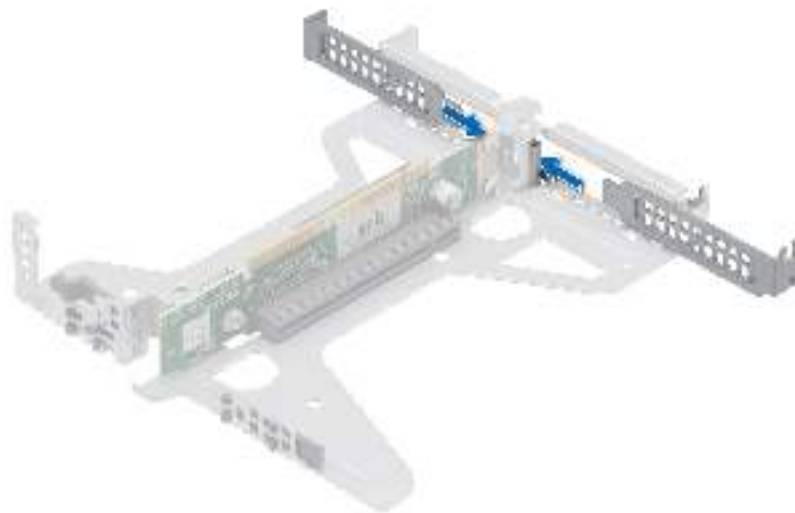

Figure 51. Installing filler bracket

Next steps

Replace the expansion card riser.

Installing the expansion card risers

Prerequisites

1. Follow the safety guidelines listed in the [Safety instructions](#).
2. Follow the procedure listed in the [Before working inside your system](#).
3. [Remove the air shroud](#).
4. If removed, install the expansion cards into the expansion card risers.

Steps

1. Holding the blue touch points on the expansion card riser, align the expansion card with the connector on the system board.
2. Lower the expansion card riser into place until the expansion card riser is fully seated with the connector on the system board.

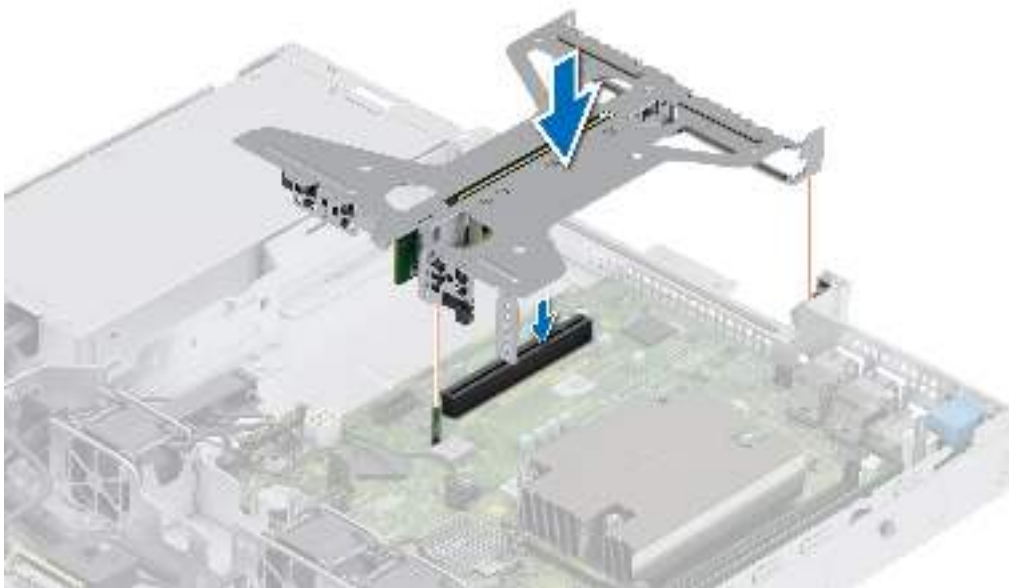

Figure 52. Installing the riser

Next steps

1. [Install the air shroud](#).
2. Follow the procedure listed in [After working inside the system](#).
3. Install any device drivers required for the card as described in the documentation for the card.

Removing expansion card from the expansion card riser

Prerequisites

1. Follow the safety guidelines listed in the [Safety instructions](#).
2. Follow the procedure listed in the [Before working inside your system](#).
3. [Remove the air shroud](#).
4. Remove the [expansion card riser](#).
5. If applicable, disconnect the cables from the expansion card.

Steps

1. Turn-over the expansion card riser, and holding the expansion card by its edges, remove the card from the riser.



Figure 53. Removing an expansion card from the Riser

2. Install a filler bracket if the expansion card is not being replaced. Close the card retention latch.

i **NOTE:** You must install a filler bracket over an empty expansion card slot to maintain Federal Communications Commission (FCC) certification of the system. The brackets also keep dust and dirt out of the system and aid in proper cooling and airflow inside the system.

i **NOTE:** The numbers on the image do not depict the exact steps. The numbers are for representation of sequence.

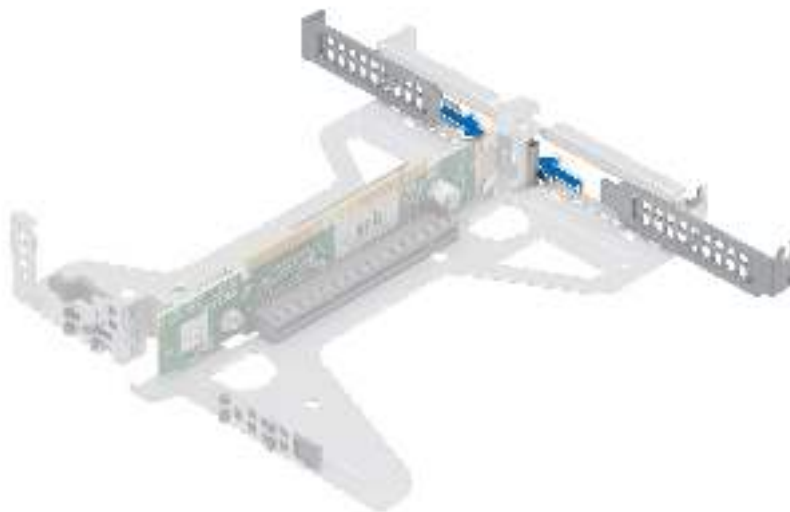

Figure 54. Installing filler bracket in the Riser

Next steps

If applicable, install an [expansion card](#) into the expansion card riser.

Installing an expansion card into the expansion card riser

Prerequisites

1. Follow the safety guidelines listed in the [Safety instructions](#).

2. Follow the procedure listed in the [Before working inside your system.](#)
3. If installing a new expansion card, unpack it and prepare the card for installation.

i **NOTE:** For instructions, see the documentation accompanying the card.

Steps

1. Remove the filler bracket.

i **NOTE:** Store the filler bracket for future use. Filler brackets must be installed in empty expansion card slots to maintain Federal Communications Commission (FCC) certification of the system. The brackets also keep dust and dirt out of the system and aid in proper cooling and airflow inside the system.

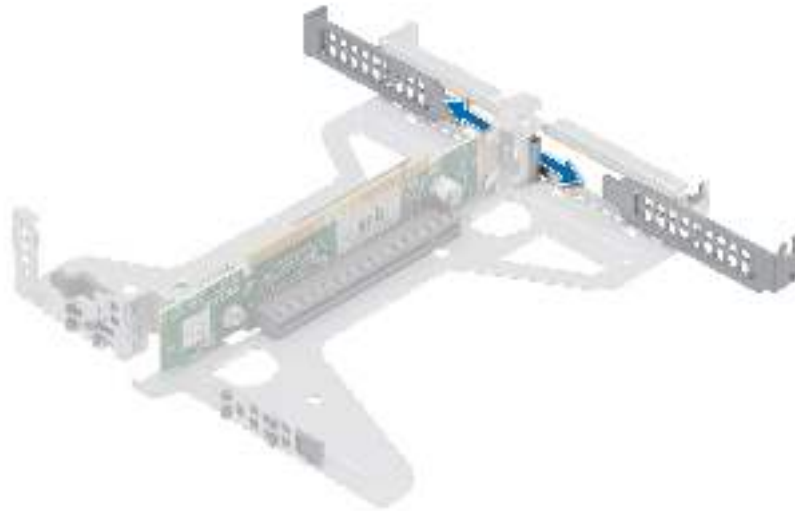

Figure 55. Removing the filler bracket

2. Hold the card by the edges, and align the card edge connector with the expansion card connector on the riser.
3. Insert the card edge connector firmly into the expansion card connector until the card is fully seated.



Figure 56. Installing the expansion card

Next steps

1. Install the [expansion card riser](#).
 2. [Install the air shroud](#).
 3. Follow the procedure listed in [After working inside the system](#).
 4. Install any device drivers required for the card as described in the documentation for the card.
- i** **NOTE:** While replacing faulty storage controller/FC/NIC card with the same type of card, after you power on the system; the new card automatically updates to the same firmware and configuration of the faulty one. For more information about the Part replacement configuration, see the *Lifecycle Controller User's Guide* at <https://www.dell.com/idracmanuals>

Optional IDSDM module

Removing the IDSDM module

Prerequisites

1. Follow the safety guidelines listed in the [Safety instructions](#).
2. Follow the procedure listed in the [Before working inside your system](#).
3. [Remove the air shroud](#).
4. If you are replacing the IDSDM card, remove the Micro-SD cards.
i **NOTE:** Temporarily label each SD card with its corresponding slot number before removal. Reinstall the SD cards into the corresponding slots.

Steps

Holding the blue pull tab, lift the IDSDM card out of the system.

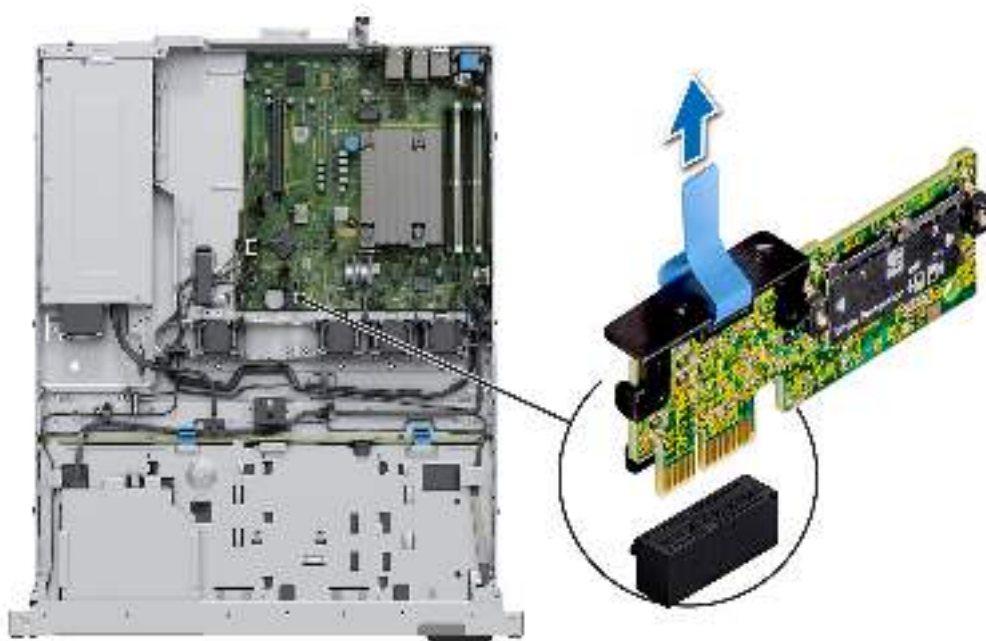

Figure 57. Removing the IDSDM module

Next steps

[Replace the IDSDM module.](#)

Installing the IDSDM module

Prerequisites

1. Follow the safety guidelines listed in the [Safety instructions](#).
2. Follow the procedure listed in the [Before working inside your system](#).
3. [Remove the air shroud](#).

Steps

1. Locate the IDSDM connector on the system board.
To locate IDSDM, see the [System board jumpers and connectors section](#).
2. Align and insert the IDSDM module into the connector on the system board, until it is firmly seated.
3. Push IDSDM module until it is firmly seated in the connector on the system board.

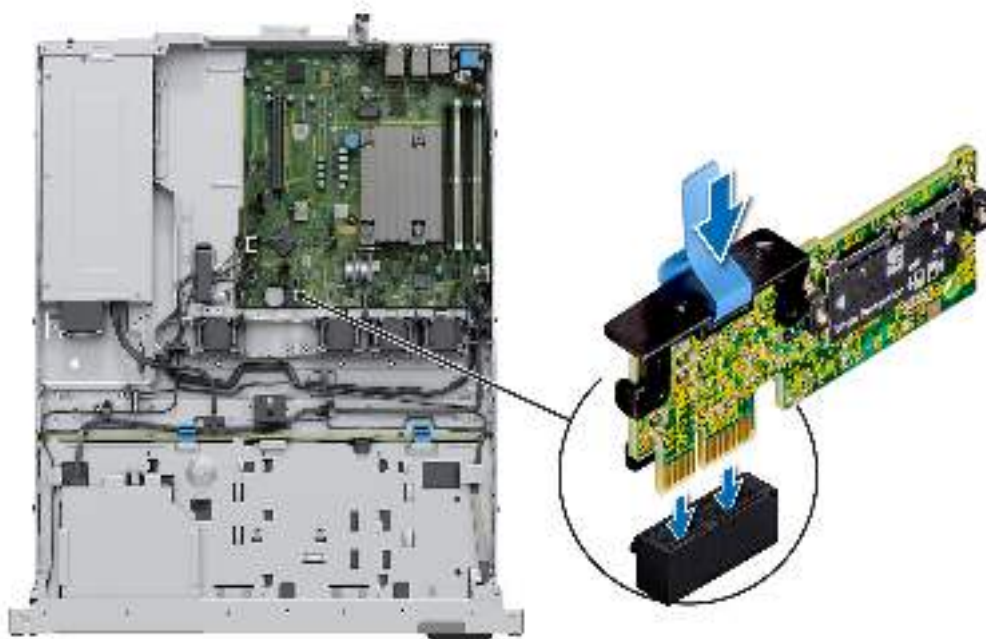

Figure 58. Installing the IDSDM module

Next steps

1. [Install the MicroSD cards](#).
NOTE: Reinstall the MicroSD cards into the same slots based on the labels you had marked on the cards during removal.
2. [Install the air shroud](#).
3. Follow the procedure listed in the [After working inside the system](#).

MicroSD card

Removing the Micro-SD card

Prerequisites

1. Follow the safety guidelines listed in the [Safety instructions](#).
2. Follow the procedure listed in the [Before working inside your system](#).
3. [Remove the air shroud](#).

4. [Remove the IDSDM module.](#)

Steps

1. Locate the Micro-SD card slot on the IDSDM module, and press the card to partially release it from the slot. For more information about the slot location, see [System board jumpers and connectors section](#).
2. Hold the Micro-SD card and remove it from the slot.

i **NOTE:** Temporarily label each Micro-SD card with its corresponding slot number after removal.



Figure 59. Removing the Micro-SD card

Next steps

[Replace the MicroSD cards.](#)

Installing the Micro-SD card

Prerequisites

1. Follow the safety guidelines listed in the [Safety instructions](#).
2. Follow the procedure listed in [Before working inside your system](#).

i **NOTE:** To use a Micro-SD card with your system, ensure that the **Internal SD Card Port** is enabled in System Setup.

i **NOTE:** Ensure that you install the Micro-SD cards into the same slots based on the labels you had marked on the cards during removal.

Steps

1. Locate the Micro-SD card slot on the IDSDM module. Orient the Micro-SD card appropriately and insert the contact-pin end of the card into the slot. To locate IDSDM, see the [System board jumpers and connectors section](#).

i **NOTE:** The slot is keyed to ensure correct insertion of the card.

2. Press the card into the slot to lock it into place.



Figure 60. Installing the Micro-SD card

Next steps

1. [Install the IDSDM module.](#)
2. [Install the air shroud.](#)
3. Follow the procedure listed in the [After working inside the system.](#)

Optional BOSS S1 card

Removing the M.2 SSD module

Prerequisites

1. Follow the safety guidelines listed in the [Safety instructions.](#)
2. Follow the procedure listed in the [Before working inside your system.](#)
3. Remove the [air shroud.](#)
4. Remove the [expansion card riser.](#)
5. Remove the BOSS S1 card from the expansion card riser.

NOTE: The procedure to remove the BOSS S1 card is similar to removing an expansion card.

Steps

1. Using the Phillips #1 screwdriver, remove the screws securing the M.2 SSD module to the BOSS S1 card.
2. Pull the M.2 SSD module to disconnect from the BOSS card connector.

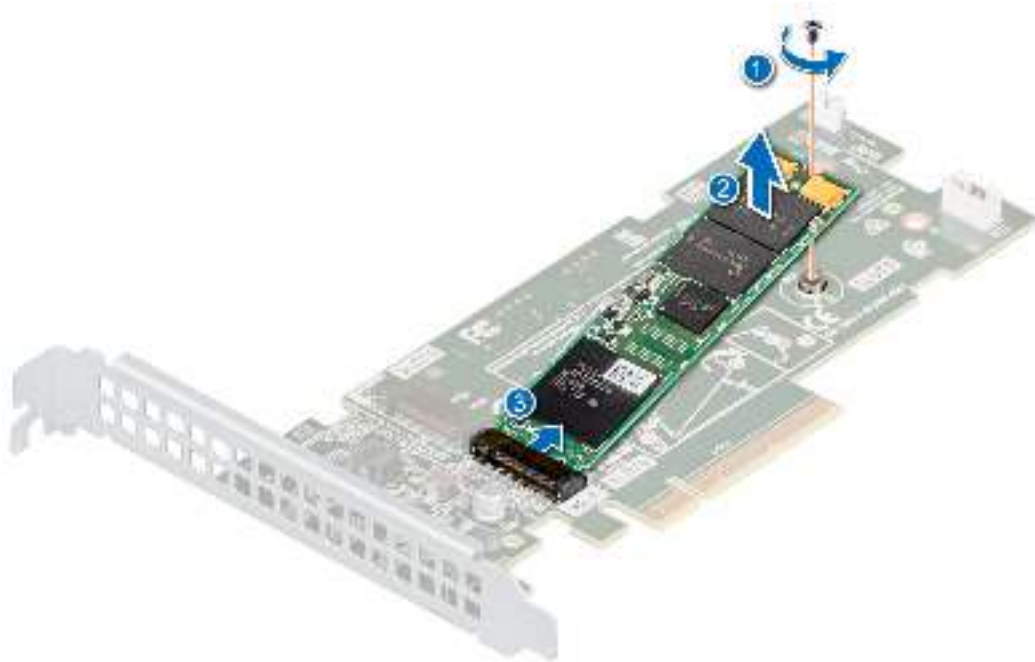

Figure 61. Removing the M.2 SSD from BOSS S1 card carrier

Next steps

1. [Replace the M.2 SSD into the BOSS S1 card module.](#)

Installing the M.2 SSD module

Prerequisites

1. Follow the safety guidelines listed in the [Safety instructions](#).
2. Follow the procedure listed in the [Before working inside your system](#).
3. Remove the [air shroud](#).

NOTE: The procedure to install the BOSS S1 card is similar to the removing an expansion card.

Steps

1. Align the M.2 SSD module at an angle with the BOSS S1 card connector.
2. Insert the M.2 SSD module until it is firmly seated in the BOSS S1 card connector.
3. Using the Phillips #1 screwdriver, secure the M.2 SSD module on the BOSS S1 card with the screw.



Figure 62. Installing the M.2 SSD module

Next steps

1. Install the BOSS S1 card in the expansion card riser.
2. Install the [expansion card riser](#).
3. Install the [air shroud](#).
4. Follow the procedure listed in the [After working inside the system](#).

PERC

This is a service technician replaceable part only.

Removing the adapter PERC

Prerequisites

1. Follow the safety guidelines listed in the [Safety instructions](#).
2. Follow the procedure listed in the [Before working inside your system](#).
3. [Remove the air shroud](#).
4. Remove the [expansion card riser](#).

Steps

1. Disconnect the SAS cables from the adapter PERC.
2. Pull out the adapter PERC from the PCIe slot on the expansion card riser.

NOTE: The numbers on the image do not depict the exact steps. The numbers are for representation of sequence.

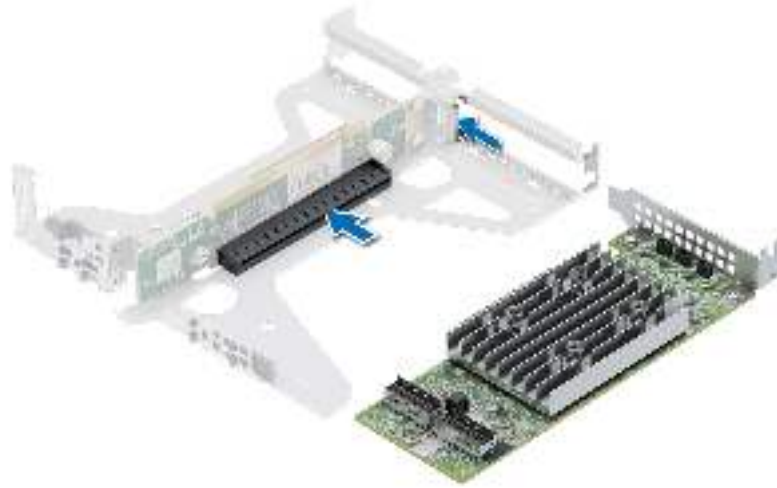

Figure 63. Removing the adapter PERC

Next steps

Replace the adapter PERC.

Installing the adapter PERC

Prerequisites

1. Follow the safety guidelines listed in the [Safety instructions](#).
2. Follow the procedure listed in [Before working inside your system](#).
3. [Remove the air shroud](#).
4. Remove the [expansion card riser](#).

Steps

1. Connect the SAS cables to the adapter PERC.
2. Holding the card by its edges, insert the adapter PERC to connect it to the connector on the riser.



Figure 64. Installing the adapter PERC

Next steps

1. Install the [expansion card riser](#).
2. [Install the air shroud](#).
3. Follow the procedure listed in [After working inside the system](#).

System battery

This is a service technician replaceable part only.

Replacing the system battery

Prerequisites

⚠ WARNING: There is a danger of a new battery exploding if it is incorrectly installed. Replace the battery only with the same or equivalent type that is recommended by the manufacturer. Discard used batteries according to the manufacturer's instructions. See the Safety instructions that came with your system for more information.

1. Follow the safety guidelines listed in the [Safety instructions](#).
2. Follow the procedure listed in the [Before working inside your system](#).
3. [Remove the air shroud](#).

Steps

1. To remove the battery:
 - a. Use a plastic scribe to pry out the system battery.

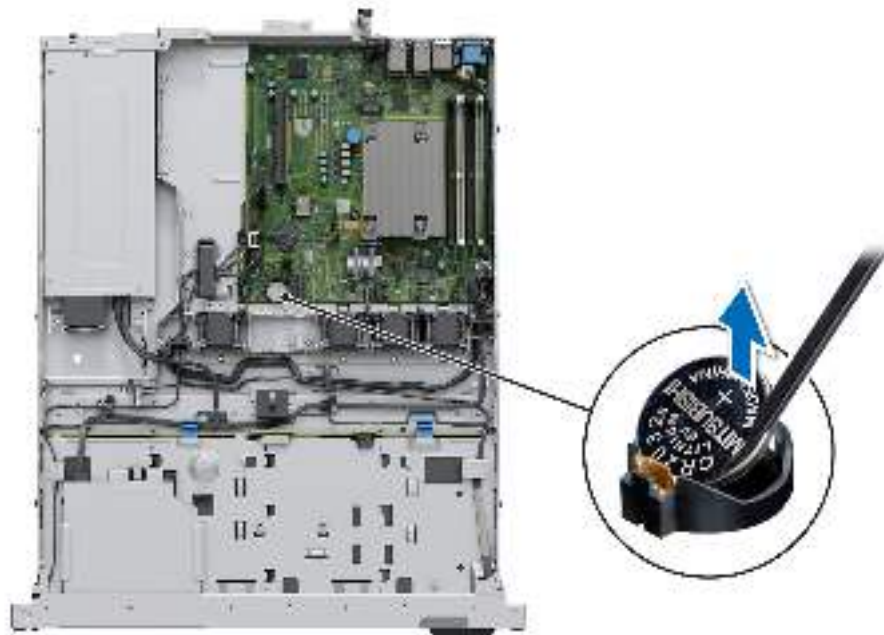

Figure 65. Removing the system battery

CAUTION: To avoid damage to the battery connector, you must firmly support the connector while installing or removing a battery.

2. To install a new system battery:
 - a. Hold the battery with the positive side facing up and slide it under the securing tabs.
 - b. Press the battery into the connector until it snaps into place.

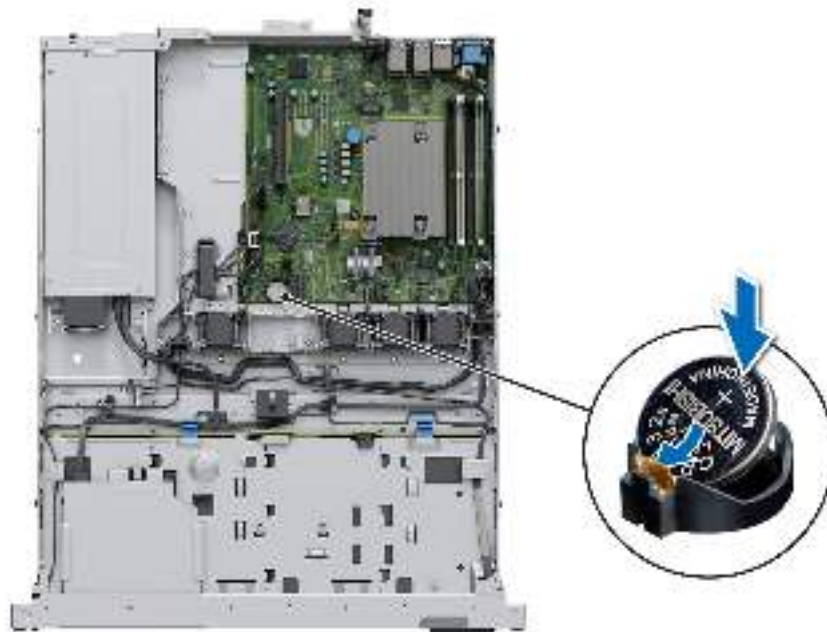

Figure 66. Installing the system battery

Next steps

1. If applicable, [install the expansion card riser](#) and connect the cables to the expansion card(s).
2. Follow the procedure listed in the [After working inside your system](#).

3. Confirm that the battery is operating properly, by performing the following steps:
 - a. Enter the System Setup, while booting, by pressing F2.
 - b. Enter the correct time and date in the System Setup **Time** and **Date** fields.
 - c. **Exit** the System Setup.
 - d. To test the newly installed battery, remove the system from the enclosure for at least an hour.
 - e. Reinstall the system into the enclosure after an hour.
 - f. Enter the System Setup and if the time and date are still incorrect, see [Getting help](#) section.

Optional internal USB card

NOTE: To locate the internal USB port on the system board, see the [System board jumpers and connectors](#) section.

Removing the internal USB key

Prerequisites

CAUTION: To avoid interference with other components in the server, the maximum permissible dimensions of the USB memory key are 15.9 mm width x 57.15 mm length x 7.9 mm height.

1. Follow the safety guidelines listed in the [Safety instructions](#).
2. Follow the procedure listed in the [Before working inside your system](#).

Steps

1. Holding the blue tag, lift the internal USB card to disconnect from the connector on the system board.
2. Remove the USB memory key from the internal USB card.

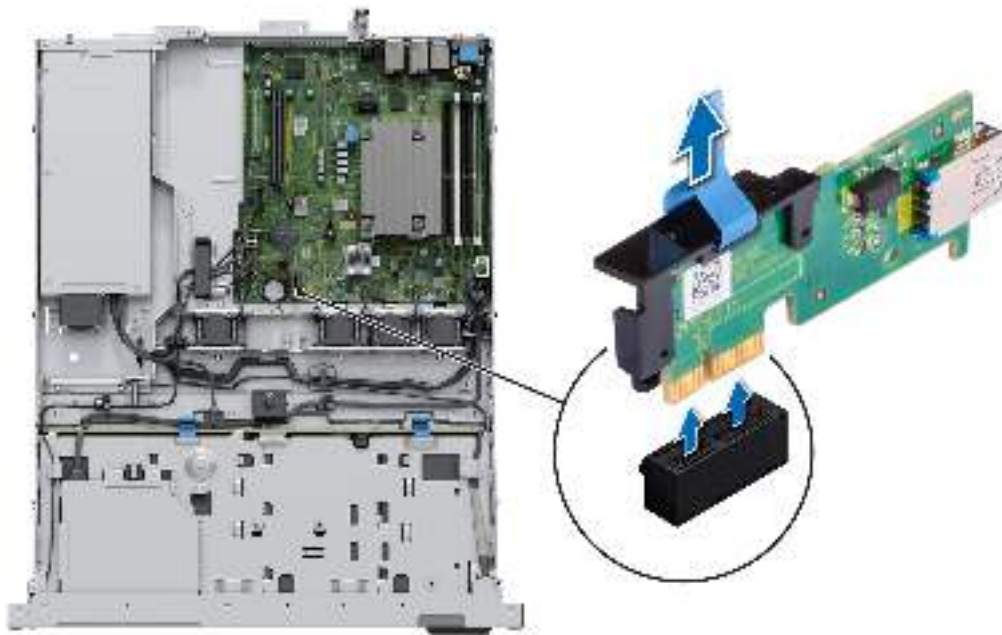

Figure 67. Removing the internal USB card

Next steps

[Replace the internal USB card.](#)

Installing the internal USB key

Prerequisites

1. Follow the safety guidelines listed in the [Safety instructions](#).
2. Follow the procedure listed in the [Before working inside your system](#).

Steps

1. Connect the USB key to the internal USB card.
2. Align the internal USB card with the connector on the system board and press firmly until the internal USB card is seated.

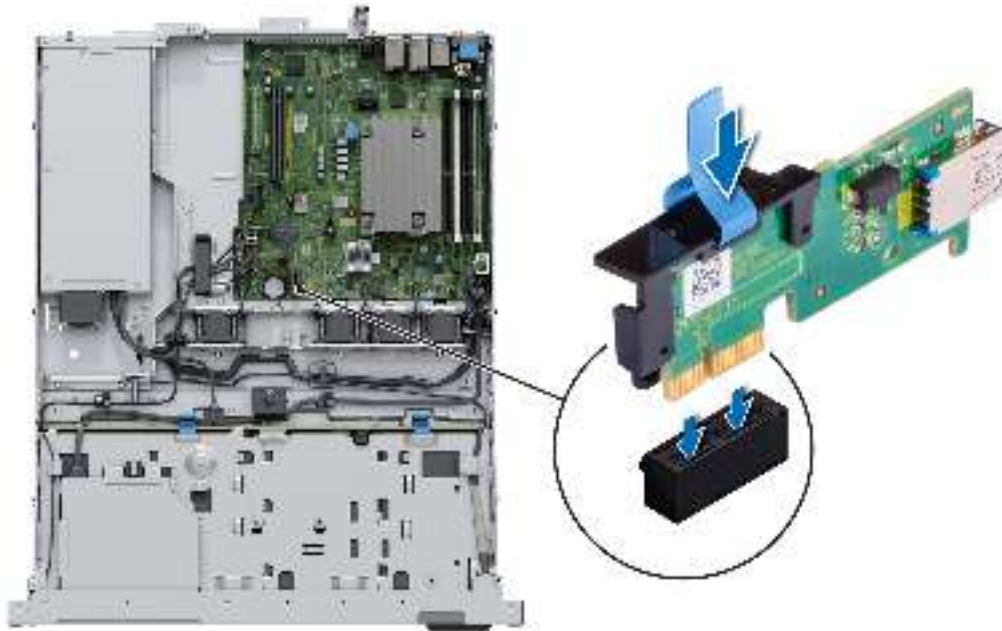

Figure 68. Installing the internal USB key

Next steps

1. Follow the procedure listed in [After working inside the system](#).
2. While booting, press F2 to enter **System Setup** and verify that the system detects the USB memory key.

Power supply unit

NOTE: While replacing the hot swappable PSU, after next server boot; the new PSU automatically updates to the same firmware and configuration of the replaced one. For updating to the latest firmware and changing the configuration, see the *Lifecycle Controller User's Guide* at <https://www.dell.com/idracmanuals>.

Removing the cabled power supply unit

Prerequisites

1. Follow the safety guidelines listed in the [Safety instructions](#).
2. Follow the procedure listed in the [Before working inside your system](#).
3. [Remove the air shroud](#).
4. Disconnect the system from the electrical outlet.
5. Disconnect all the cables that are connected from the PSU to the system board and the backplane.

6. If applicable, remove the [expansion card riser](#).
7. Unlatch and lift the optional cable management arm if it interferes with the PSU removal. For information about the cable management arm, see the system rack documentation at <https://www.dell.com/poweredgemanuals>.

Steps

1. Using a Phillips #2 screwdriver, remove the screw securing the PSU to the system.
2. Slide the PSU out of the PSU bay in the chassis.

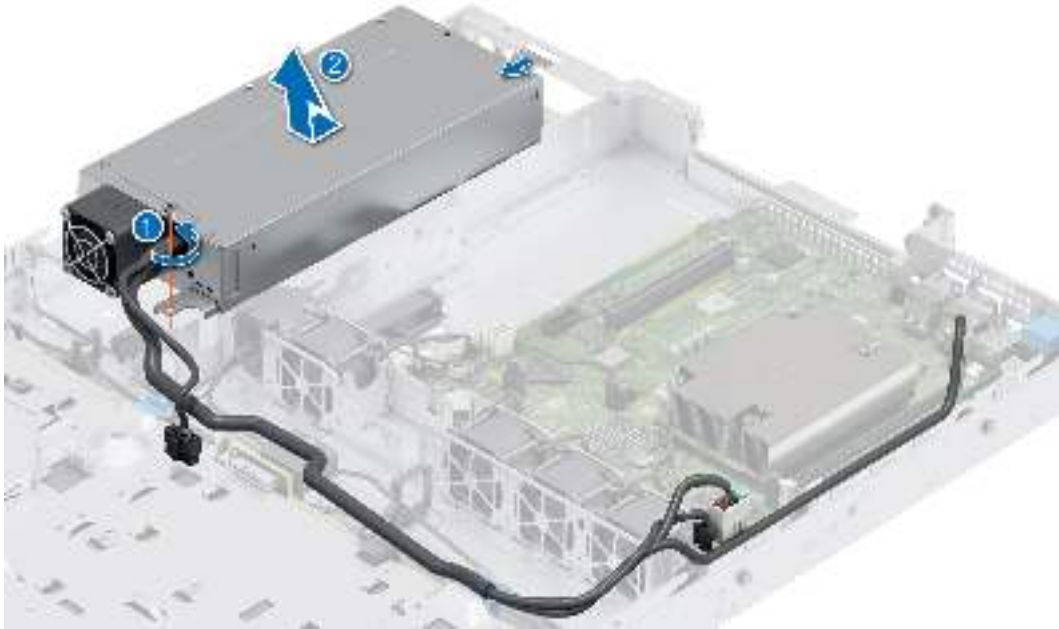

Figure 69. Removing the cabled power supply unit

Next steps

[Replace the PSU.](#)

Installing a power supply unit

Prerequisites

1. Follow the safety guidelines listed in the [Safety instructions](#).
2. Follow the procedure listed in the [Before working inside your system](#).
3. [Remove the air shroud](#).
4. Remove the [expansion card riser](#).

Steps

1. Slide the new PSU into the PSU bay in the chassis until the PSU is fully seated.
2. Using a Phillips #2 screwdriver, replace the screw to secure the PSU to the system.

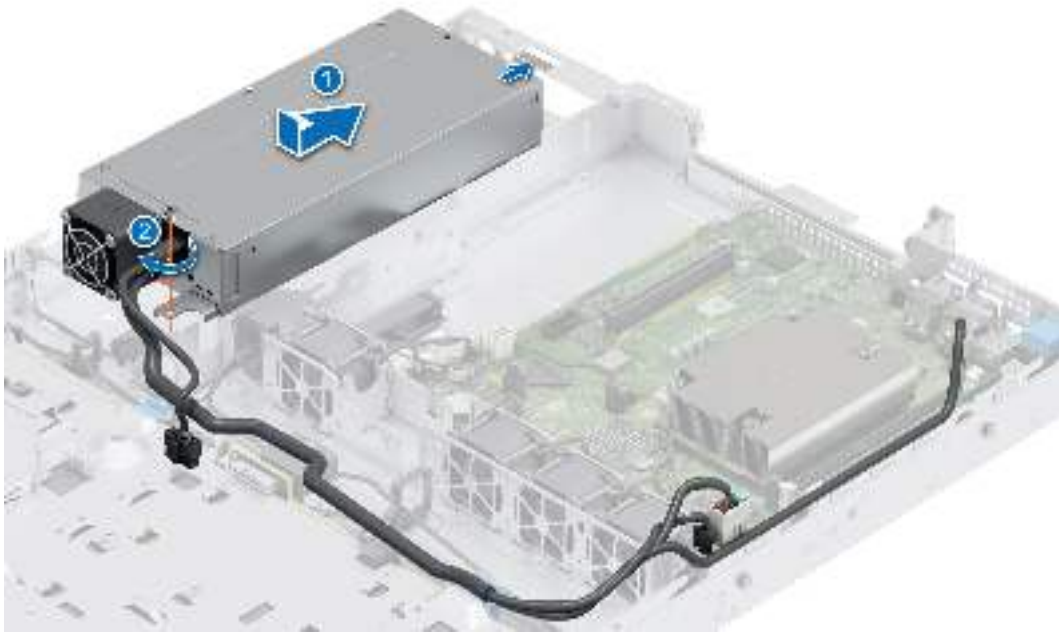

Figure 70. Installing the cabled power supply unit

Next steps

1. If you have unlatched the cable management arm, relatch it. For information about the cable management arm, see the system rack documentation at <https://www.dell.com/poweredgemanuals>.
2. Connect the power cable to the PSU, and plug the cable into a power outlet.
CAUTION: When connecting the power cable to the PSU, secure the cable to the PSU with the strap.
3. Connect the PSU cables to the connectors on the system board and the backplane.
4. [Install the air shroud.](#)

NOTE: While replacing the hot swappable PSU, after next server boot; the new PSU automatically updates to the same firmware and configuration of the replaced one. For more information about the Part replacement configuration, see the *Lifecycle Controller User's Guide* at <https://www.dell.com/idracmanuals>

System board

This is a service technician replaceable part only.

Removing the system board

Prerequisites

CAUTION: If you are using the Trusted Platform Module (TPM) with an encryption key, you may be prompted to create a recovery key during program or System Setup. Be sure to create and safely store this recovery key. If you replace this system board, you must supply the recovery key when you restart your system or program before you can access the encrypted data on your drives.

1. Follow the safety guidelines listed in the [Safety instructions](#).
2. Follow the procedure listed in the [Before working inside your system](#).
3. Remove the following components:
 - a. [System cover](#)
 - b. [Air shroud](#)
 - c. [Cooling fans](#)

- d. Expansion cards
- e. Expansion card risers
- f. Intrusion switch
- g. IDSDM module (if installed)
- h. Internal USB key (if installed)
- i. Processor heat sink
- j. Memory modules
- k. Disconnect all cables from the system board.

 **CAUTION:** Take care not to damage the system identification button while removing the system board from the system.

Steps

1. Remove all the screws from the system board.
2. Slide the system board towards the front of the system and lift the system board out of the chassis leaning at an angle.

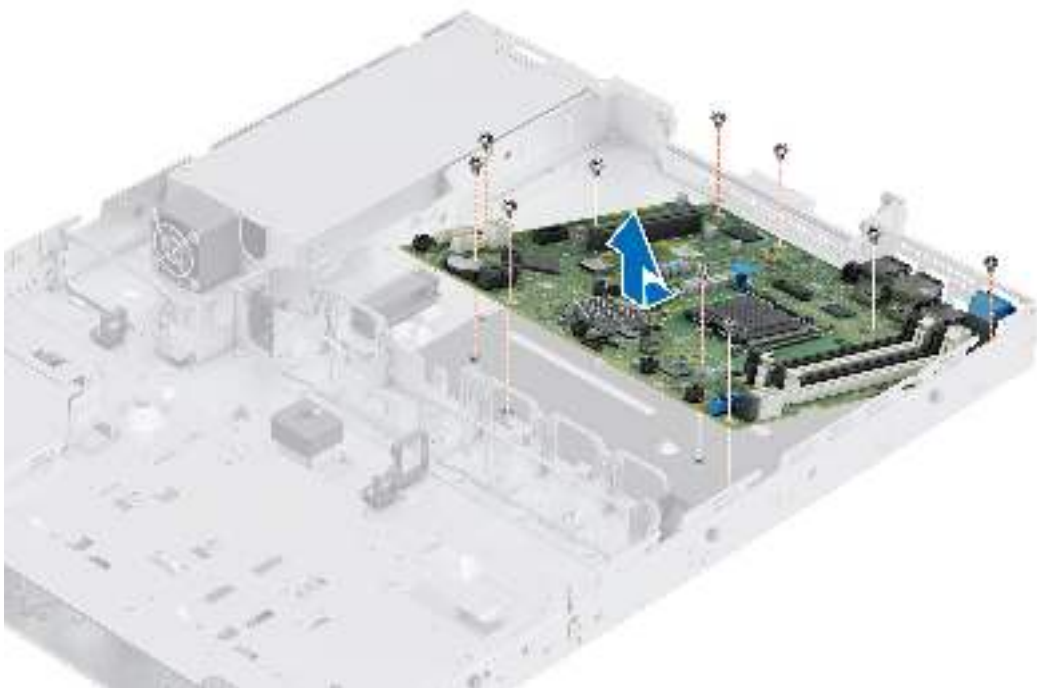



Figure 71. Removing the system board

Next steps

Replace the system board.

Installing the system board

Prerequisites

 **NOTE:** Before replacing the system board, replace the old iDRAC MAC address label in the Information tag with the iDRAC MAC address label of the replacement system board.

1. Follow the safety guidelines listed in the [Safety instructions](#).
2. Follow the procedure listed in [Before working inside your system](#).
3. If you are replacing the system board, remove all the components that are listed in the [removing the system board](#) section.

Steps

1. Unpack the new system board assembly.

CAUTION: Do not lift the system board by holding a memory module, processor, or other components.

CAUTION: Take care not to damage the system identification button while placing the system board into the chassis.

2. Lower the system board at an angle into the system, as shown in the image.
3. Slide the system board towards the rear of the chassis until the connectors are firmly seated in the slots.

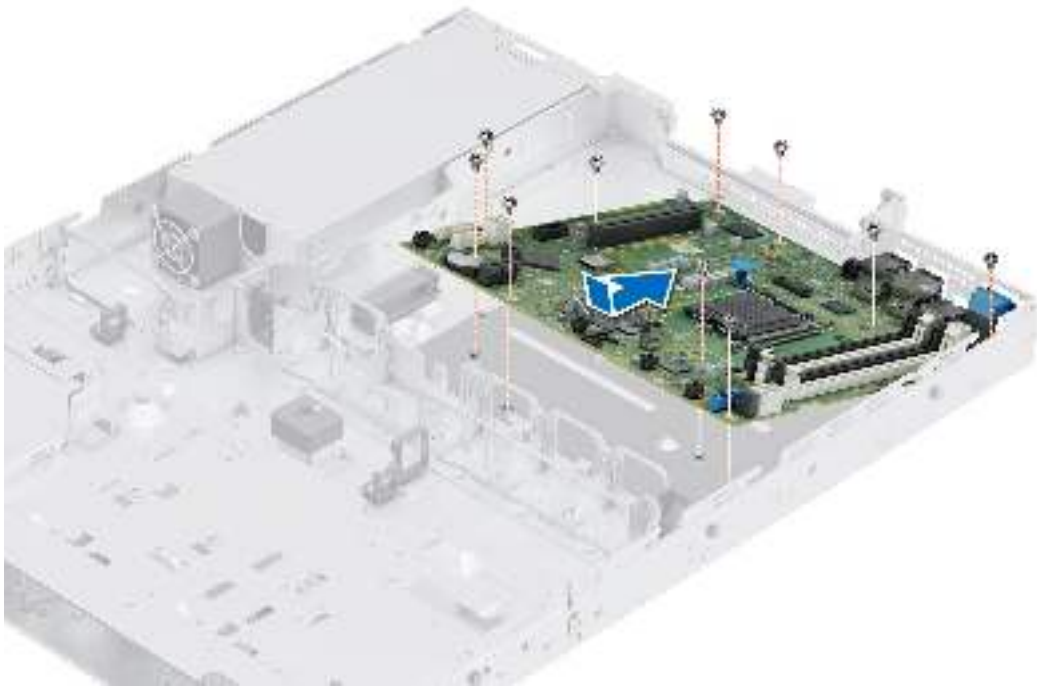

Figure 72. Installing the system board

4. Tighten all the screws and ensure the system board is firmly seated.

Next steps

1. Replace the following components:

- a. Trusted Platform Module (TPM)

NOTE: The TPM Module must be replaced only while installing new system board.

- b. IDSDM module (if installed)
- c. Internal USB key (if installed)
- d. Intrusion switch
- e. Expansion cards
- f. Expansion card risers
- g. Cooling fans
- h. Processor
- i. Heat sink
- j. Memory modules
- k. Air shroud
- l. System cover

2. Reconnect all cables to the system board.

NOTE: Ensure that the cables inside the system are routed along the chassis wall and secured using the cable securing bracket.



3. Ensure that you perform the following steps:
 - a. Use the Easy Restore feature to restore the Service Tag. See the [Restoring the system by using the Easy Restore feature](#) section.
 - b. If the service tag is not backed up in the backup flash device, enter the system service tag manually. See the [Manually update the Service Tag by using System Setup](#) section.
 - c. Update the BIOS and iDRAC versions.
Re-enable the Trusted Platform Module (TPM). See the [Upgrading the Trusted Platform Module](#) section.
4. If you are not using Easy restore, import your new or existing iDRAC Enterprise license. For more information, see the *Integrated Dell Remote Access Controller User's Guide* available at <https://www.dell.com/idracmanuals>.
5. Follow the procedure listed in [After working inside the system](#).

Restoring the system using Easy Restore

The Easy Restore feature enables you to restore your service tag, license, UEFI configuration, and the system configuration data after replacing the system board. All data is backed up in a backup flash device automatically. If BIOS detects a new system board, and the service tag in the backup flash device, BIOS prompts the user to restore the backup information.

About this task

Below is a list of options/steps available:

- Restore the service tag, license, and diagnostics information, press **Y**
- Navigate to the Lifecycle Controller based restore options, press **N**
- Restore data from a previously created **Hardware Server Profile**, press **F10**
 **NOTE:** When the restore process is complete, BIOS prompts to restore the system configuration data.
- Restore data from a previously created **Hardware Server Profile**, press **F10**
- To restore the system configuration data, press **Y**
- To use the default configuration settings, press **N**
-  **NOTE:** After the restore process is complete, system reboots.

Manually update the Service Tag

After replacing a system board, if Easy Restore fails, follow this process to manually enter the Service Tag, using **System Setup**.

About this task

If you know the system service tag, use the **System Setup** menu to enter the service tag.

Steps

1. Power on the system.
2. To enter the **System Setup**, press **F2**.
3. Click **Service Tag Settings**.
4. Enter the service tag.
 **NOTE:** You can enter the service tag only when the **Service Tag** field is empty. Ensure that you enter the correct service tag. Once the service tag is entered, it cannot be updated or changed.
5. Click **OK**.

Trusted Platform Module

This is a service technician replaceable part only.

Upgrading the Trusted Platform Module

Removing the TPM

Prerequisites

NOTE:

- Ensure the operating system is compatible with the TPM version you are installing.
- Ensure that you download and install the latest BIOS firmware on your system.
- Ensure that the BIOS is configured to enable UEFI boot mode.

 **CAUTION:** The TPM plug-in module is cryptographically bound to that particular system board after it is installed. When the system is powered on, any attempt to remove an installed TPM plug-in module breaks the cryptographic binding, and the removed TPM cannot be installed on another system board. Ensure any keys you have stored on the TPM have been securely transferred.

Steps

1. Locate the TPM connector on the system board. For more information, see [System board connectors](#).
2. Press to hold the module down and remove the screw using the security Torx 8-bit shipped with the TPM module.
3. Slide the TPM module out from its connector.
4. Push the plastic rivet away from the TPM connector and rotate it 90° counterclockwise to release it from the system board.
5. Pull the plastic rivet out of its slot on the system board.

Installing the TPM

Steps

1. To install the TPM, align the edge connectors on the TPM with the slot on the TPM connector.
2. Insert the TPM into the TPM connector such that the plastic rivet aligns with the slot on the system board.
3. Press the plastic rivet until the rivet snaps into place.
4. Replace the screw that secures the TPM to the system board.



Figure 73. Installing the TPM

Initializing TPM for users

Steps

1. Initialize the TPM.
For more information, see [Initializing the TPM for users](#).
2. The **TPM Status** changes to **Enabled, Activated**.

Initializing the TPM 1.2 for users

Steps

1. While booting your system, press F2 to enter System Setup.
2. On the **System Setup Main Menu** screen, click **System BIOS > System Security Settings**.
3. From the **TPM Security** option, select **On with Preboot Measurements**.
4. From the **TPM Command** option, select **Activate**.
5. Save the settings.
6. Restart your system.

Initializing the TPM 2.0 for users

Steps

1. While booting your system, press F2 to enter System Setup.
2. On the **System Setup Main Menu** screen, click **System BIOS > System Security Settings**.
3. From the **TPM Security** option, select **On**.
4. Save the settings.
5. Restart your system.

Control panel

This is a service technician replaceable part only.

Removing the left control panel

Prerequisites

1. Follow the safety guidelines listed in the [Safety instructions](#).
2. Follow the procedure listed in the [Before working inside your system](#).
3. [Remove the front bezel](#).
4. [Remove the air shroud](#).

Steps

1. Disconnect the control panel cable from the system board connector.
 **NOTE:** Observe the routing of the cable as you remove it from the system.
2. Using the Phillips #1 screwdriver, remove the screws that secure the left control panel assembly to the system.
3. Hold the left control panel assembly and remove the control panel along with the cable from the system.

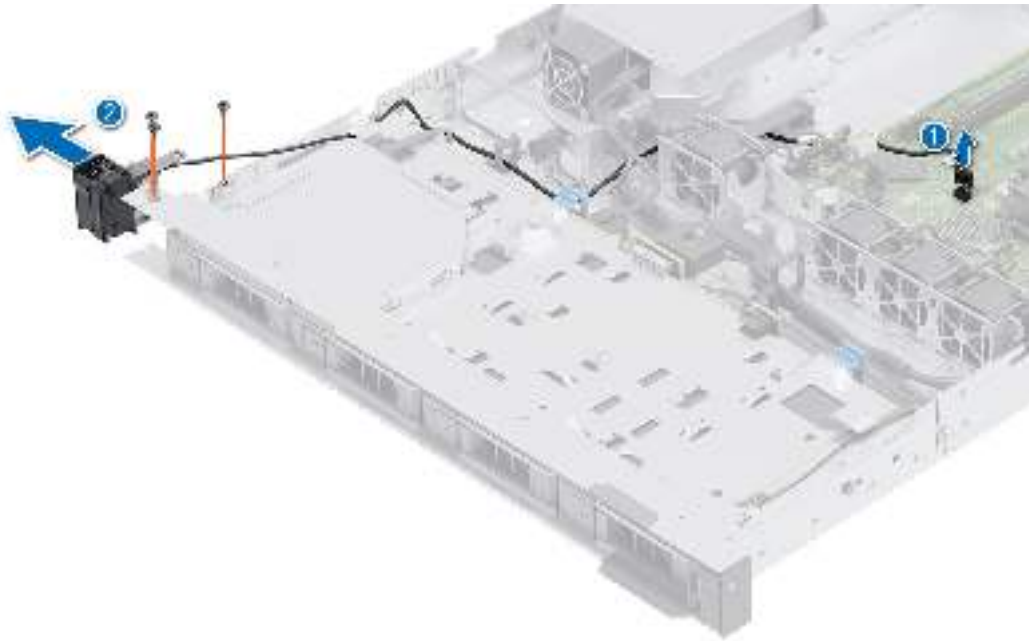

Figure 74. Removing the left control panel

Next steps

Replace the left control panel.

Installing the left control panel

Prerequisites

1. Follow the safety guidelines listed in the [Safety instructions](#).
2. Follow the procedure listed in the [Before working inside your system](#).
3. [Remove the front bezel](#).
4. [Remove the air shroud](#).

Steps

1. Route the control panel cable through the side and the guide slots in the system.

NOTE: Route the cable properly to prevent the cable from being pinched or crimped.

2. Align and insert the left control panel assembly in the slot on the system.
3. Connect the control panel cable to the system board connector.
4. Using the Phillips #1 screwdriver, tighten the screws that secure the left control panel assembly to the system.

NOTE: The numbers on the image do not depict the exact steps. The numbers are for representation of sequence.

Figure 75. Installing the left control panel

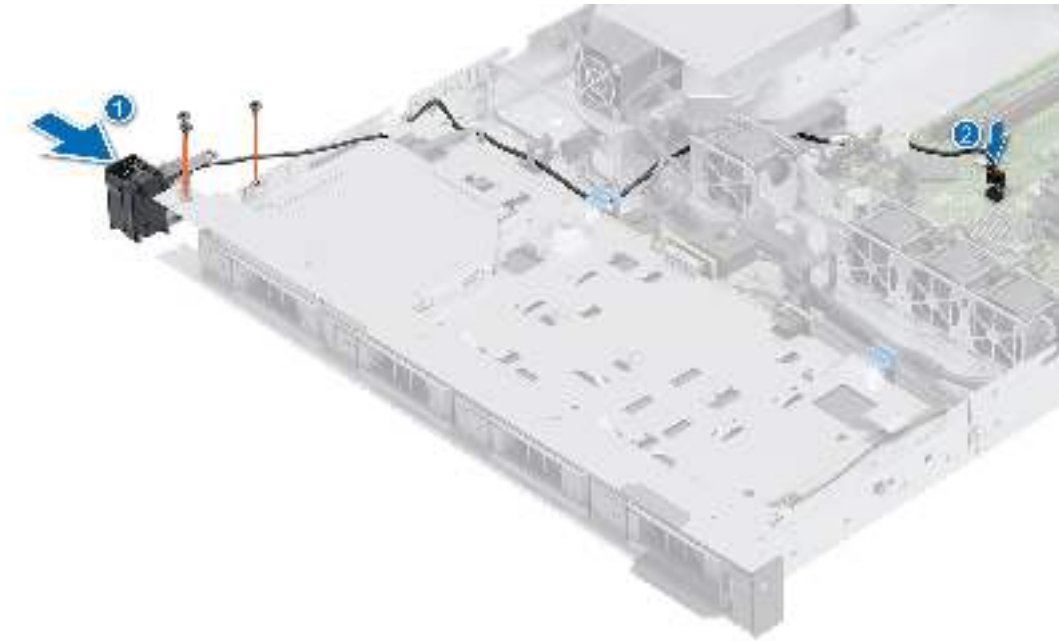

Next steps

1. [Replace the air shroud.](#)
2. [Replace front bezel.](#)
3. Follow the procedure listed in the [After working inside your system.](#)

Removing the right control panel

Prerequisites

1. Follow the safety guidelines listed in the [Safety instructions.](#)
2. Follow the procedure listed in the [Before working inside your system.](#)
3. [Remove the front bezel.](#)
4. [Remove the air shroud.](#)

Steps

1. Disconnect the control panel cable from the system board connector.

i **NOTE:** Observe the routing of the cable as you remove it from the system.

2. Using the Phillips #1 screwdriver, remove the screws that secure the right control panel assembly.
3. Hold the right control panel assembly and remove the control panel along with the cable from the system.

i **NOTE:** The numbers on the image do not depict the exact steps. The numbers are for representation of sequence.

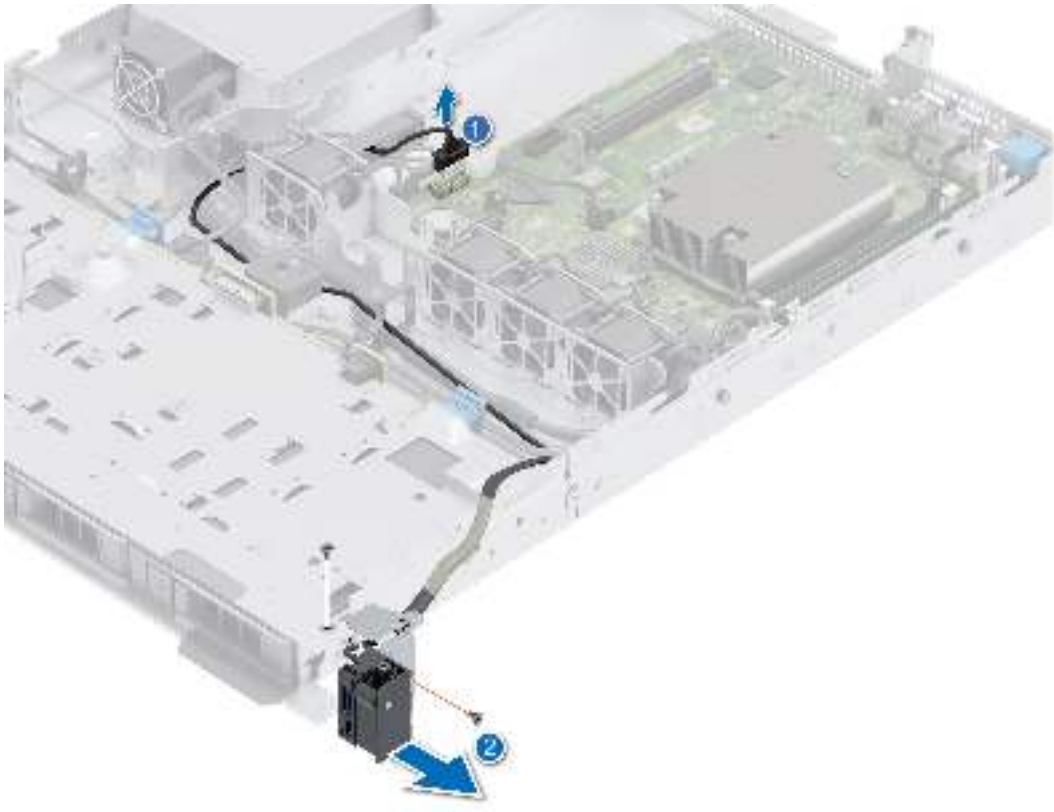

Figure 76. Removing the right control panel

Next steps

Replace the right control panel.

Installing the right control panel

Prerequisites

1. Follow the safety guidelines listed in the [Safety instructions](#).
2. Follow the procedure listed in the [Before working inside your system](#).
3. [Remove the front bezel](#).
4. [Remove the air shroud](#).

Steps

1. Route the control panel cable through the side wall of the system and slide the cable into the clip.

(i) NOTE: Route the cable properly to prevent the cable from being pinched or crimped.

2. Align and insert the right control panel in the slot on the system.
3. Connect the right control panel cable to the connector on the system board.
4. Using the Phillips #1 screwdriver, tighten the screws that secure the right control panel to the system.

(i) NOTE: The numbers on the image do not depict the exact steps. The numbers are for representation of sequence.

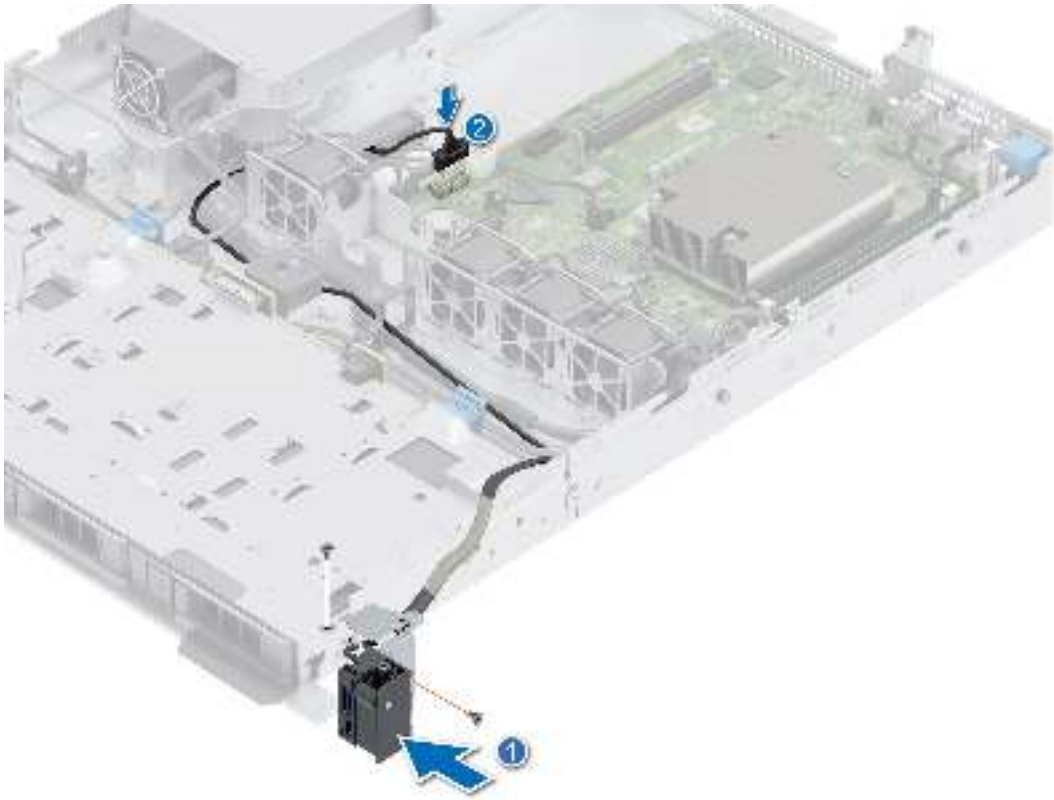

Figure 77. Installing the right control panel

Next steps

1. [Install the air shroud.](#)
2. [Install the front bezel.](#)
3. Follow the procedure listed in the [After working inside your system.](#)

Jumpers and connectors

This section provides essential and specific information about jumpers and switches. It also describes the connectors on the various boards in the system. Jumpers on the system board help to disable the system and reset the passwords. To install components and cables correctly, you must be able to identify the connectors on the system board.

Topics:

- [System board connectors](#)
- [System board jumper settings](#)
- [Disabling a forgotten password](#)

System board connectors

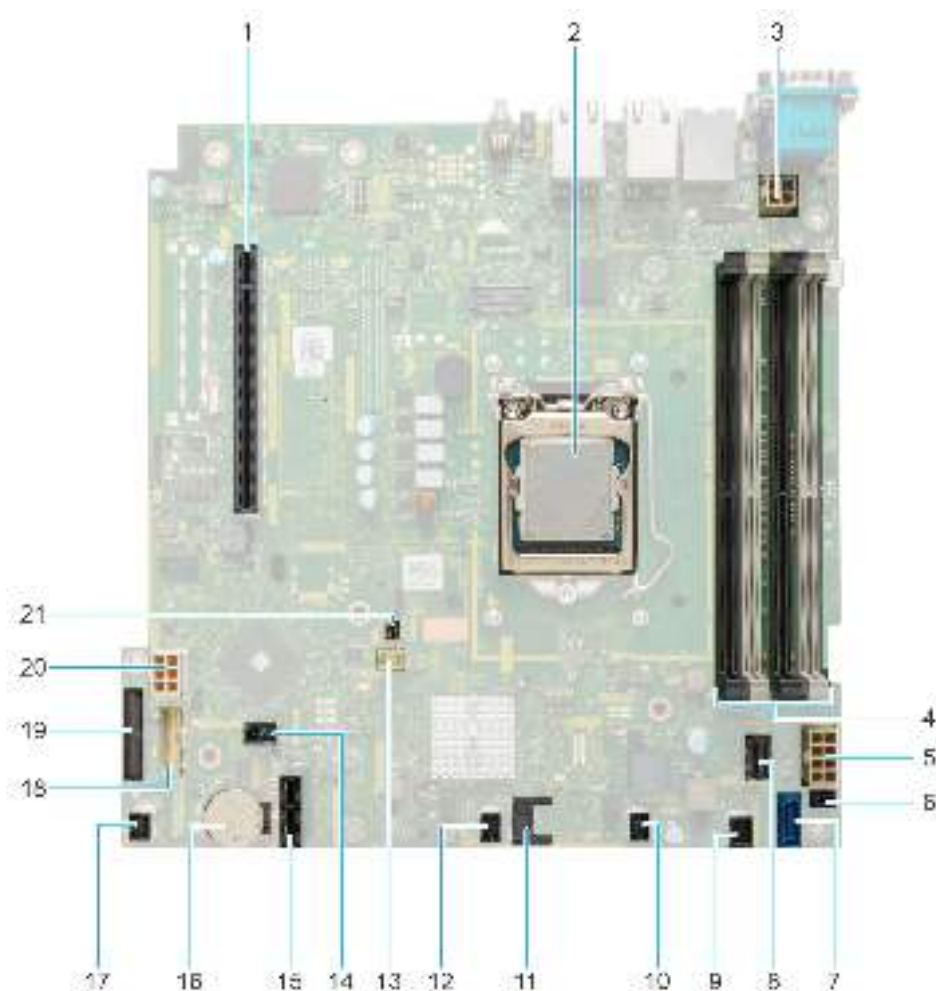

Figure 78. System board jumpers and connectors





1. Riser connector
2. Processor
3. Processor power connector
4. DIMM slots

- 5. System power connector
- 6. Power Event
- 7. SATA ODD
- 8. SATA 0-3
- 9. Fan 4
- 10. Fan 3
- 11. TPM
- 12. Fan 2
- 13. Left Control Panel connector
- 14. Intrusion connector
- 15. IDSDM/ internal USB card
- 16. System battery
- 17. Fan 1
- 18. Right Control Panel connector
- 19. PIB connector
- 20. HDD and ODD power
- 21. PWRD_EN and NVRAM_CLR jumper

System board jumper settings

For information about resetting the password jumper to disable a password, see the [Disabling a forgotten password](#) section.

Table 22. System board jumper settings

Jumper	Setting	Description
PWRD_EN	 2 4 6 (Default)	The BIOS password feature is enabled.
	 1 3 5	The BIOS password feature is disabled. The BIOS password is now disabled and you are not allowed to set a new password.
NVRAM_CLR	 1 3 5 (Default)	The BIOS configuration settings are retained at system boot.
	 2 4 6	The BIOS configuration settings are cleared at system boot.

CAUTION: You should be cautious when changing the BIOS settings. The BIOS interface is designed for advanced users. Any changes in the setting might prevent your system from starting correctly and may even result in data loss.

Disabling a forgotten password

The software security features of the system include a system password and a setup password. The password jumper enables or disables password features and clears any password(s) currently in use.

Prerequisites

CAUTION: Many repairs may only be done by a certified service technician. You should only perform troubleshooting and simple repairs as authorized in your product documentation, or as directed by the online or telephone service and support team. Damage due to servicing that is not authorized by Dell is not covered by your warranty. Read and follow the safety instructions that are shipped with your product.

Steps

1. Power off the system and all attached peripherals. Disconnect the system from the electrical outlet, and disconnect the peripherals.
2. Remove the system cover.

3. Move the jumper on the system board from pins 2 and 4 to pins 4 and 6.

4. Replace the system cover.

i **NOTE:** The existing passwords are not disabled (erased) until the system boots with the jumper on pins 4 and 6. However, before you assign a new system and/or setup password, you must move the jumper back to pins 2 and 4.

i **NOTE:** If you assign a new system and/or setup password with the jumper on pins 4 and 6, the system disables the new password(s) the next time it boots.

5. Reconnect the peripherals and connect the system to the electrical outlet, and then power on the system.

6. Power off the system.

7. Remove the system cover.

8. Move the jumper on the system board from pins 4 and 6 to pins 2 and 4.

9. Replace the system cover.

10. Reconnect the peripherals and connect the system to the electrical outlet, and then power on the system.

11. Assign a new system and/or setup password.

System diagnostics and indicator codes

This section describes the diagnostic indicators on the system front panel that displays the system status during system startup.

Topics:

- [Non-redundant cabled power supply unit indicator codes](#)
- [Using system diagnostics](#)

Non-redundant cabled power supply unit indicator codes

Press the self-diagnostic button to perform a quick health check on the non-redundant cabled power supply unit (PSU) of the system.



Figure 79. Non-redundant cabled AC PSU status indicator and self-diagnostic button

1. Self-diagnostic button
2. AC PSU status indicator

Table 23. Non-redundant AC PSU status indicator

Power Indicator Pattern	Condition
Not lit	Power is not connected or PSU is faulty.
Green	A valid power source is connected to the PSU and the PSU is operational.

Using system diagnostics

If you experience an issue with the system, run the system diagnostics before contacting Dell for technical assistance. The purpose of running system diagnostics is to test the system hardware without using additional equipment or risking data loss. If you are unable to fix the issue yourself, service and support personnel can use the diagnostics results to help you solve the issue.

Dell Embedded System Diagnostics

NOTE: The Dell Embedded System Diagnostics is also known as Enhanced Pre-boot System Assessment (ePSA) diagnostics.

The Embedded System Diagnostics provide a set of options for particular device groups or devices allowing you to:

- Run tests automatically or in an interactive mode
- Repeat tests
- Display or save test results
- Run thorough tests to introduce additional test options to provide extra information about the failed device(s)
- View status messages that inform you if tests are completed successfully
- View error messages that inform you of issues encountered during testing

Running the Embedded System Diagnostics from the Dell Lifecycle Controller

Steps

1. When the system is booting, press F10.
2. Select **Hardware Diagnostics** → **Run Hardware Diagnostics**.
The **ePSA Pre-boot System Assessment** window is displayed, listing all devices detected in the system. The diagnostics start executing the tests on all the detected devices.

Running the Embedded System Diagnostics from Boot Manager

Run the Embedded System Diagnostics (ePSA) if your system does not boot.

Steps

1. When the system is booting, press F11.
2. Use the up arrow and down arrow keys to select **System Utilities** > **Launch Diagnostics**.
3. Alternatively, when the system is booting, press F10, select **Hardware Diagnostics** > **Run Hardware Diagnostics**.
The **ePSA Pre-boot System Assessment** window is displayed, listing all devices detected in the system. The diagnostics starts executing the tests on all the detected devices.

System diagnostic controls

Table 24. System diagnostic controls

Menu	Description
Configuration	Displays the configuration and status information of all detected devices.
Results	Displays the results of all tests that are run.
System health	Provides the current overview of the system performance.
Event log	Displays a time-stamped log of the results of all tests run on the system. This is displayed if at least one event description is recorded.

Getting help

Topics:

- [Recycling or End-of-Life service information](#)
- [Contacting Dell Technologies](#)
- [Accessing system information by using QRL](#)
- [Receiving automated support with SupportAssist](#)

Recycling or End-of-Life service information

Take back and recycling services are offered for this product in certain countries. If you want to dispose of system components, visit www.dell.com/recyclingworldwide and select the relevant country.

Contacting Dell Technologies

Dell provides online and telephone based support and service options. If you do not have an active internet connection, you can find Dell contact information on your purchase invoice, packing slip, bill or Dell product catalog. The availability of services varies depending on the country and product, and some services may not be available in your area. To contact Dell for sales, technical assistance, or customer service issues follow these steps:

Steps

1. Go to www.dell.com/support/home.
2. Select your country from the drop-down menu on the lower right corner of the page.
3. For customized support:
 - a. Enter the system Service Tag in the **Enter a Service Tag, Serial Number, Service Request, Model, or Keyword** field.
 - b. Click **Search**.
The support page that lists the various support categories is displayed.
4. For general support:
 - a. Select your product category.
 - b. Select your product segment.
 - c. Select your product.
The support page that lists the various support categories is displayed.
5. For contact details of Dell Global Technical Support:
 - a. Click [Contact Technical Support](#).
 - b. The **Contact Technical Support** page is displayed with details to call, chat, or e-mail the Dell Global Technical Support team.

Accessing system information by using QRL

You can use the Quick Resource Locator (QRL) located on the information tag in the of the R250 system, to access information about Dell Technologies PowerEdge R250. There is also another QRL for accessing product information located on the back of the system cover.

Prerequisites

Ensure that your smartphone or tablet has a QR code scanner installed.

The QRL includes the following information about your system:

- How-to videos
- Reference materials, including the Installation and Service Manual, and mechanical overview
- The system service tag to quickly access the specific hardware configuration and warranty information
- A direct link to Dell to contact technical assistance and sales teams

Steps

1. Go to www.dell.com/qrl, and navigate to your specific product or
2. Use your smart phone or tablet to scan the model-specific Quick Resource (QR) code on your system or in the Quick Resource Locator section.

Quick Resource Locator for PowerEdge R250 system



Figure 80. Quick Resource Locator for PowerEdge R250 system

Receiving automated support with SupportAssist

Dell EMC SupportAssist is an optional Dell EMC Services offering that automates technical support for your Dell EMC server, storage, and networking devices. By installing and setting up a SupportAssist application in your IT environment, you can receive the following benefits:

- Automated issue detection — SupportAssist monitors your Dell EMC devices and automatically detects hardware issues, both proactively and predictively.
- Automated case creation — When an issue is detected, SupportAssist automatically opens a support case with Dell EMC Technical Support.
- Automated diagnostic collection — SupportAssist automatically collects system state information from your devices and uploads it securely to Dell EMC. This information is used by Dell EMC Technical Support to troubleshoot the issue.

- Proactive contact — A Dell EMC Technical Support agent contacts you about the support case and helps you resolve the issue.

The available benefits vary depending on the Dell EMC Service entitlement purchased for your device. For more information about SupportAssist, go to www.dell.com/supportassist.

Documentation resources

This section provides information about the documentation resources for your system.

To view the document that is listed in the documentation resources table:

- From the Dell Technologies support site:
 1. Click the documentation link that is provided in the Location column in the table.
 2. Click the required product or product version.
-  **NOTE:** To locate the model number, see the front of your system.
- 3. On the Product Support page, click **Documentation**.
- Using search engines:
 - Type the name and version of the document in the search box.

Table 25. Additional documentation resources for your system

Task	Document	Location
Setting up your system	<p>For more information about installing and securing the system into a rack, see the Rail Installation Guide included with your rail solution.</p> <p>For information about setting up your system, see the <i>Getting Started Guide</i> document that is shipped with your system.</p>	www.dell.com/poweredgemanuals
Configuring your system	<p>For information about the iDRAC features, configuring and logging in to iDRAC, and managing your system remotely, see the Integrated Dell Remote Access Controller User's Guide.</p> <p>For information about understanding Remote Access Controller Admin (RACADM) subcommands and supported RACADM interfaces, see the RACADM CLI Guide for iDRAC.</p> <p>For information about Redfish and its protocol, supported schema, and Redfish Eventing implemented in iDRAC, see the Redfish API Guide.</p> <p>For information about iDRAC property database group and object descriptions, see the Attribute Registry Guide.</p> <p>For information about Intel QuickAssist Technology, see the Integrated Dell Remote Access Controller User's Guide.</p>	www.dell.com/poweredgemanuals
	<p>For information about earlier versions of the iDRAC documents.</p> <p>To identify the version of iDRAC available on your system, on the iDRAC web interface, click ? > About.</p>	www.dell.com/idracmanuals

Table 25. Additional documentation resources for your system (continued)

Task	Document	Location
	For information about installing the operating system, see the operating system documentation.	www.dell.com/operatingsystemmanuals
	For information about updating drivers and firmware, see the Methods to download firmware and drivers section in this document.	www.dell.com/support/drivers
Managing your system	For information about systems management software offered by Dell, see the Dell OpenManage Systems Management Overview Guide.	www.dell.com/poweredgemanuals
	For information about setting up, using, and troubleshooting OpenManage, see the Dell OpenManage Server Administrator User's Guide.	www.dell.com/openmanagemanuals > OpenManage Server Administrator
	For information about installing and using Dell SupportAssist, see the Dell EMC SupportAssist Enterprise User's Guide.	https://www.dell.com/serviceabilitytools
	For information about partner programs enterprise systems management, see the OpenManage Connections Enterprise Systems Management documents.	www.dell.com/openmanagemanuals
Working with the Dell PowerEdge RAID controllers	For information about understanding the features of the Dell PowerEdge RAID controllers (PERC), Software RAID controllers, or BOSS card and deploying the cards, see the Storage controller documentation.	www.dell.com/storagecontrollermanuals
Understanding event and error messages	For information about the event and error messages generated by the system firmware and agents that monitor system components, go to qrl.dell.com > Look Up > Error Code , type the error code, and then click Look it up .	www.dell.com/qrl
Troubleshooting your system	For information about identifying and troubleshooting the PowerEdge server issues, see the Server Troubleshooting Guide.	www.dell.com/poweredgemanuals