

LED Loading Dock Light

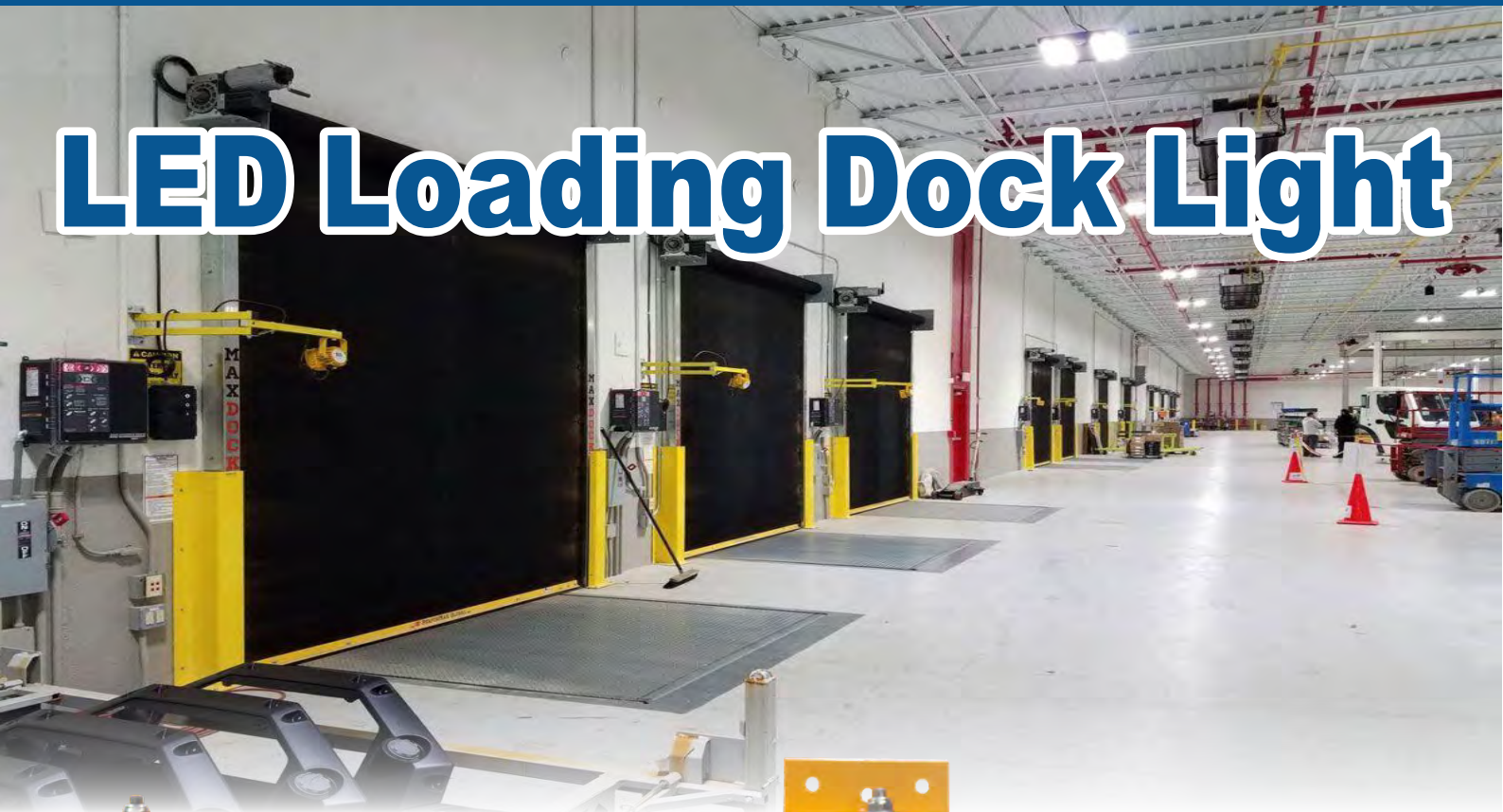

DESCRIPTION

G JIA led loading dock light is designed for a variety of warehouse and work space conditions, led loading bay dock lights used to illuminate the full length of truck trailers.

These dock light fixtures increase safety during loading and unloading.



KEY FEATURE



20W/30W/40W/50W

- Using CREE LEDs, high lumens up to 140LPW
- Safety yellow rugged cast aluminum housing
- Come with an on/off switch on the light head for easy operation
- High light transmittance PC cover
- Anti-corrosion stainless steel cage with good impact resistance
- High reliable constant current LED driver
- Available in multiple swing brackets optional
- ETL/cETL/FCC/CE/RoHS approved
- >50,000 hours lifespan, offer 5 years warranty

SPECIFICATION

Item NO.	Watt	Total Lumens	Dimension	Beam Angle	LED Brand	CCT	Input Voltage	CRI	Power Factor	IP Rating
RMS-L200120	20W	2800LM±10%	Φ 219*163*70mm	30°	CREE	3000K 4000K 5000K 5700K 6500K	AC100-277V, 50-60Hz	≥70+	≥0.9	IP65
RMS-L200130	30W	4200LM±10%								
RMS-L200140	40W	5600LM±10%								
RMS-L200150	50W	7000LM±10%								

DIMENSION

Unit: inch/mm

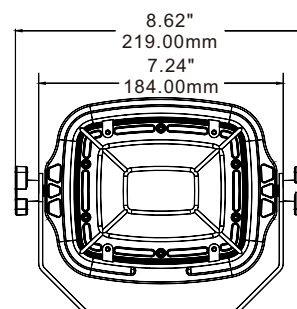
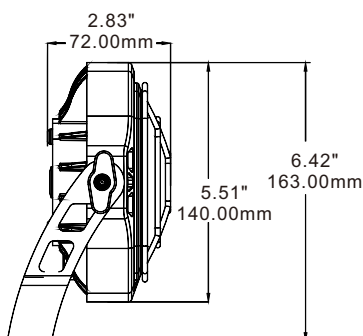

DETAILS

1/ Lumens effect up to 140LPW
Using CREE LED, has a higher junction temperature, extend lifetime and lower light degradation.



2/ 30° PC Lens
It is spot lighting for longer irradiation distance, suitable for illuminate the full length of truck trailers.



4/ Hand twists screw
Bracket is adjusted for different lighting direction by fixed screw



3/ Stainless steel cage
Durable design with good impact resistance, anti-corrosion

5/ Safety yellow aluminum housing
Die-cast aluminum housing with fin design for excellent cooling effect



6/ Connector design
Come with 1ft(300mm) regular waterproof connector; 120V grounded US plug is optional



7/ ON-OFF switch button
Built-in switch to control on-off condition, easy operation and more convenient

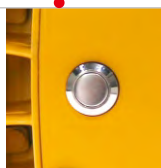

8/ OEM label service offered
Offer customized label design can be laser on the back side of lamp

PRODUCT DISPLAY



Single Arm



Double Arm



Arm with the receptacles

Cord length of bracket is 5ft(1500mm),
120v US grounded plug optional

BRACKET

Single Arm

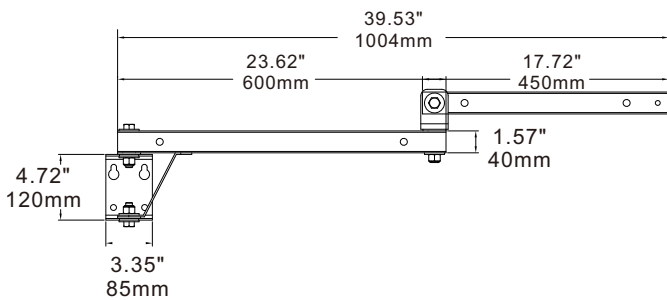

40" Bracket A1

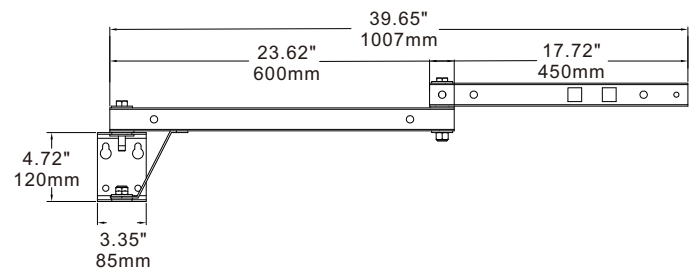

40" Bracket A2, Built-in receptacle

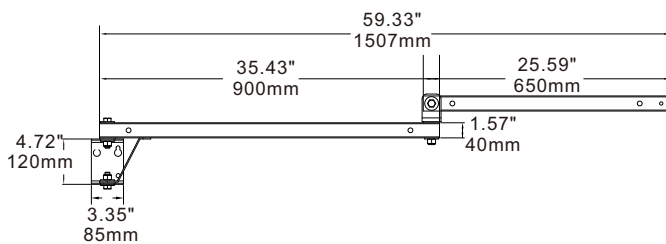

60" Bracket A3

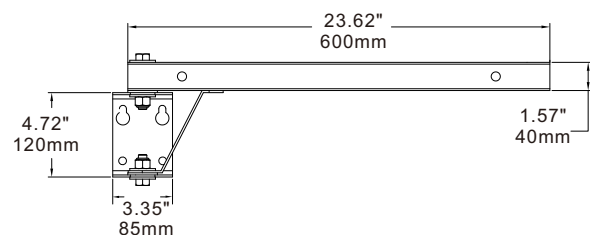

24" Bracket A4

Double Arm

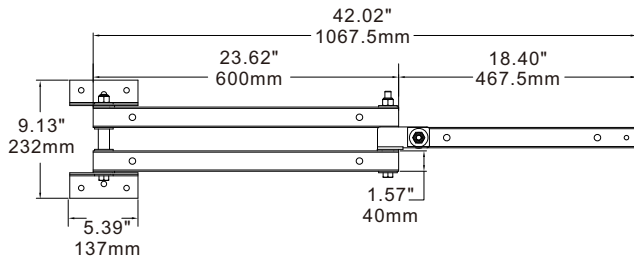

40" Bracket B1

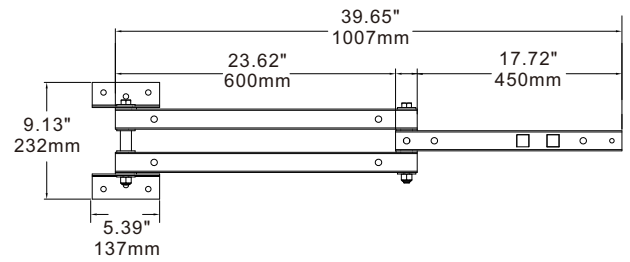

40" Bracket B2, Built-in receptacle

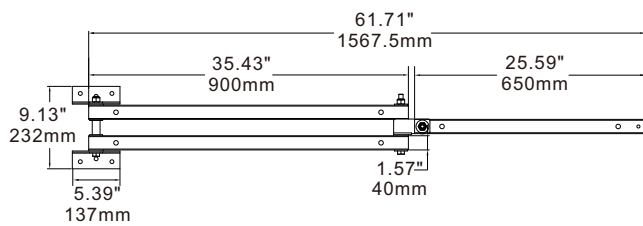

60" Bracket B3

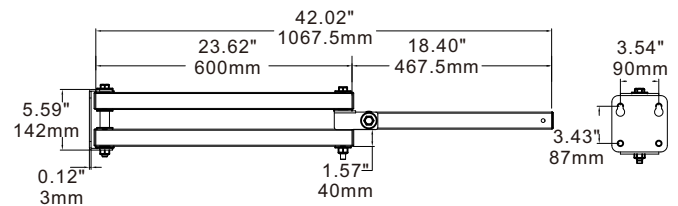

40" Bracket C1

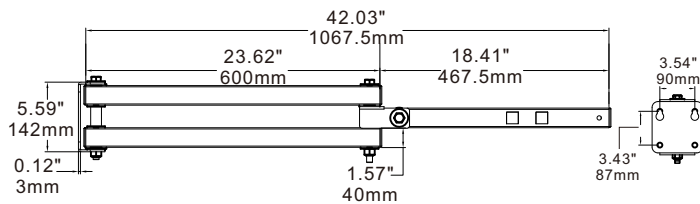

40" Bracket C2, Built-in receptacle

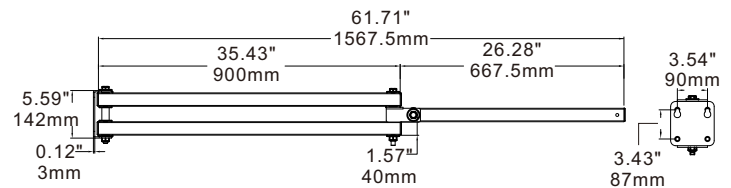

60" Bracket C3

APPLICATION

Applications include shipping and receiving loading docks, machine stations such as a stamping press, inspection stations, general work lighting, indoor and outdoor spot lighting, and other similar applications.

