

LED Dock Light



DESCRIPTION

G GJIA LED dock lights provide light into trailers during the loading and unloading process with a high-visibility beam of light attached to an adjustable arm. This lights create a productive, safe and OSHA compliant working environment. Illuminates trailers with bright, long lasting, and energy efficient lighting on a heavy-duty design, made for applications that are susceptible to wear and damage. It delivers lower energy cost with high quality superior light over incandescent, quartz or metal halide technologies traditionally used in loading dock applications.



KEY FEATURE

- Optimum brightness for entire length of trailer.
- Built-in switch to control on-off.
- Adjustable screw on the lamp, adjust lamp's angle by hand.
- Eliminates light bulb replacement and/or clean-up.
- Compact design utilizes aluminum housing for cooling system.
- High-visibility beam angles for optional.
- Cree LED is available.
- Over 50000 hours lifetime and offer 5 years warranty.
- ETL/cETL/CE/RoHS certificates.



20W/30W

50W/60W

SPECIFICATION

Item NO.	Watt	Total Lumens	Dimension	Beam Angle	LED Brand	CCT	Input Voltage	CRI	Power Factor	IP Rating
RMS-DL-20W	20W	2200LM±10%	Φ177*115.8mm	20°/30°/110°	CREE	3000K 4000K 5000K 5700K 6500K	AC100-277V, 50-60Hz	>70	>0.9	IP65
RMS-DL-30W	30W	3300LM±10%								
RMS-DL-50W	50W	5500LM±10%	Φ240*118.5mm	30°/80°/110°						
RMS-DL-60W	60W	6600LM±10%								

DIMENSION

Unit: inch/mm

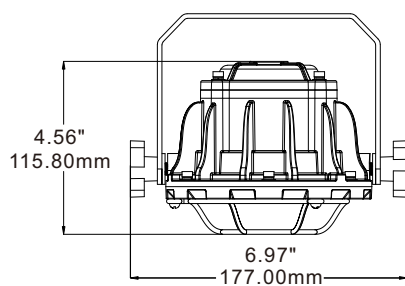

20W/30W

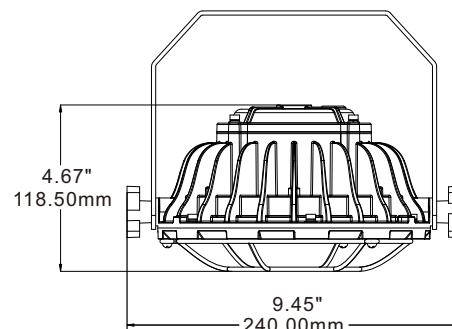

50W/60W

DETAILS

CREE

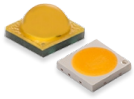

1/ BRANDED LED
Cree LED are available, LM80 report, long lifetime.



20° / 30° / 110°



30° / 80° / 110°

2/ BEAM ANGLES

High-visibility beam angles for optional:
20W /30W : 20°/30°/110°,
50W /60W : 30°/80°/110°.



3/ ALUMINUM HOUSING
Die-cast aluminum housing for maximum heat dissipation.



4/ REAR SWITCH BUTTON
Built-in switch to control on-off condition.



5/ STAINLESS STEEL CAGE
Better protection for light, anti-corrosion and durable.



6/ ELECTRICAL OUTLET

Come with 1ft(300mm) regular waterproof connector; US/EU/AU plug is optional



7/ CORD
Come with 5ft(1.5m) cord.



8/ ADJUSTABLE SCREW

Can be adjusted with different lighting direction.

DISPLAY

5' long 18/3 conductor cord, US/EU/AU plug optional
Customized swing bracket design can be customized according your requirements.



Double Arm



Single Arm

BRACKET

Single Arm

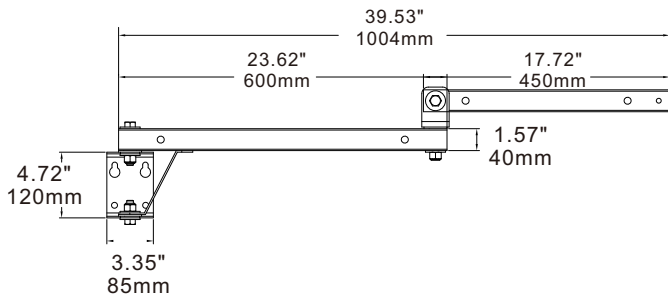

40" Bracket A1

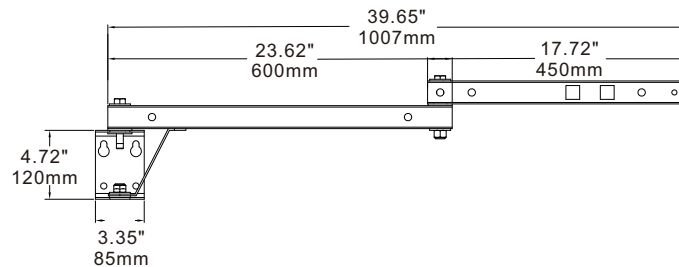

40" Bracket A2, Built-in receptacle

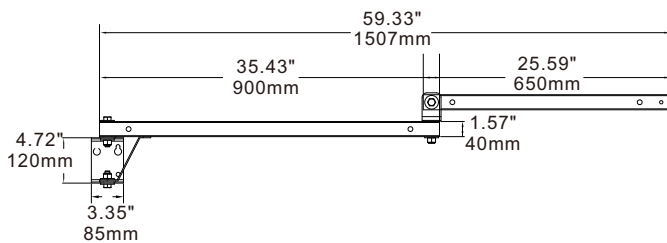

60" Bracket A3

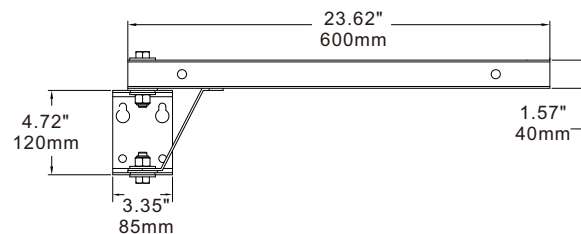

24" Bracket A4

Double Arm

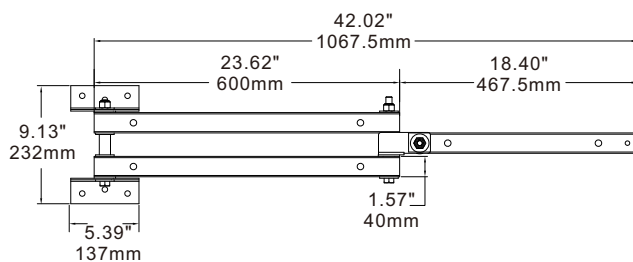

40" Bracket B1

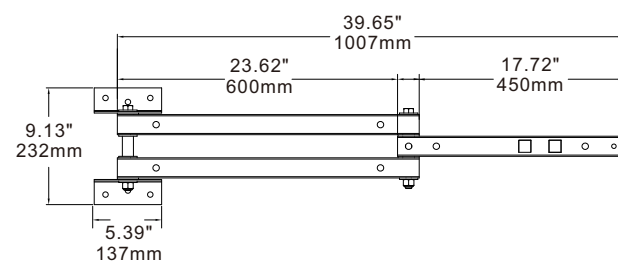

40" Bracket B2, Built-in receptacle

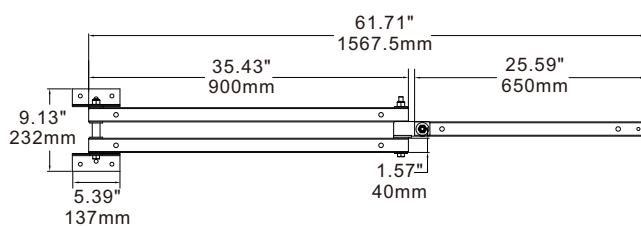

60" Bracket B3

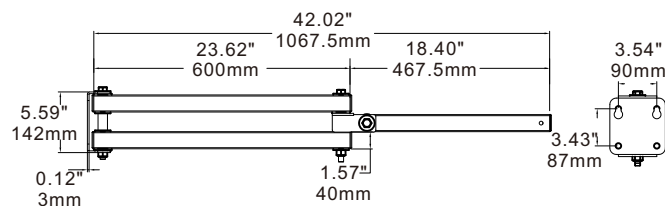

40" Bracket C1

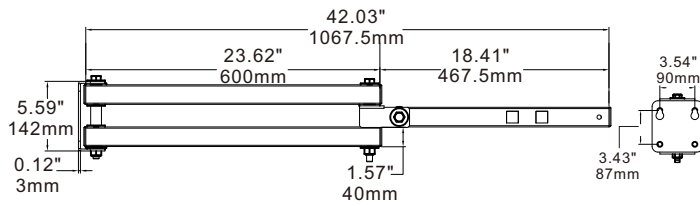

40" Bracket C2, Built-in receptacle

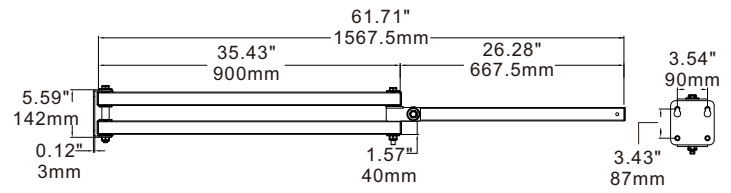

60" Bracket C3

APPLICATION

LED dock light is designed for industrial, manufacturing and warehousing, that is also a perfect LED replacement for traditional incandescent/HPS yellow fixture, illuminate tractor trailers for loading and unloading.

Applications include shipping and receiving loading docks, machine stations such as a stomping press, inspection stations, general work lighting, indoor and outdoor spot lighting, and other similar applications.

