

# iTECHWORLD

## CONTROL HUB USER MANUAL





# TABLE OF CONTENTS

Important Safety Features -----	1
Overview -----	2
Whats Included -----	2
Features -----	3
Wiring Diagram -----	4
Wiring With DCDC Charger -----	4
Wiring Without DCDC Charger -----	5
Connections & Accessories -----	6
Outputs -----	7
Inputs/Outputs -----	8
Fuse Box -----	9
Switch Lighting -----	9
Getting Started -----	10
Mounting Instructions -----	10
Wiring Instructions -----	12
Wiring In Switches -----	12
Connecting To Battery -----	14
DCDC Charger Model -----	17
Connecting The DCDC Charger -----	17
Connecting Solar Input -----	18
Non DCDC Charger Model -----	19
Mounting Items On The Control Hub -----	19
DIY DCDC Install -----	20
Wiring Diagram -----	21



# IMPORTANT SAFETY FEATURES

- The lid of the unit must remain shut at all times when the battery is connected to the control hub.
- Any 12V installation work should be done by a professional, failing to do this may result in damage to your unit or vehicle.
- Ensure suitable gauge wiring is used.
- Do not allow any loose metal objects to fall inside the control hub or enter the ports.
- It is the customers responsibility to ensure the unit is adequately mounted.
- Ensure the control hub is shut and the screws are tight before attempting to power any devices.
- In order to prevent an accumulation of heat, ensure there is adequate ventilation to the control hub.
- Do not expose the control hub to excessive moisture or dust.
- Ensure the manual and warnings are understood.



# OVERVIEW

## WHATS INCLUDED



1 X CONTROL HUB (WITH OPTIONAL DCDC CHARGER)



3MM HEX KEY



MIDI FUSE

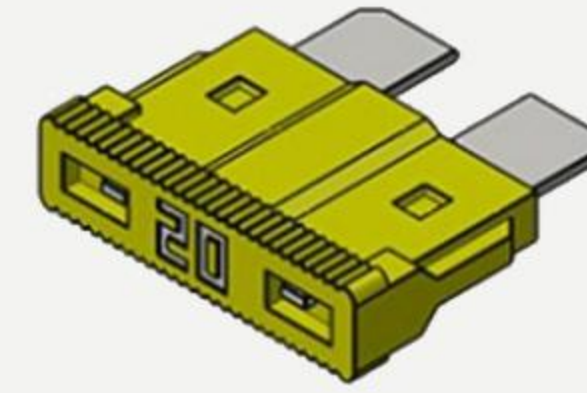
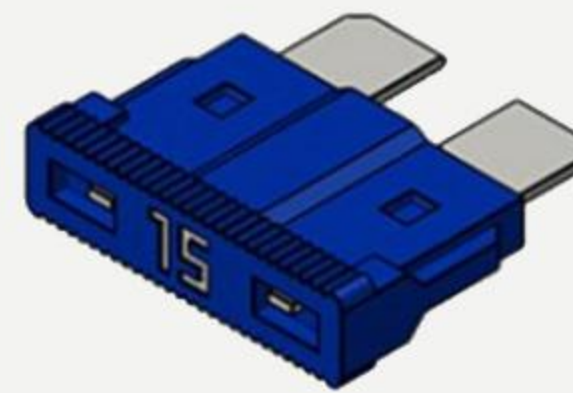

STD BLADE FUSE

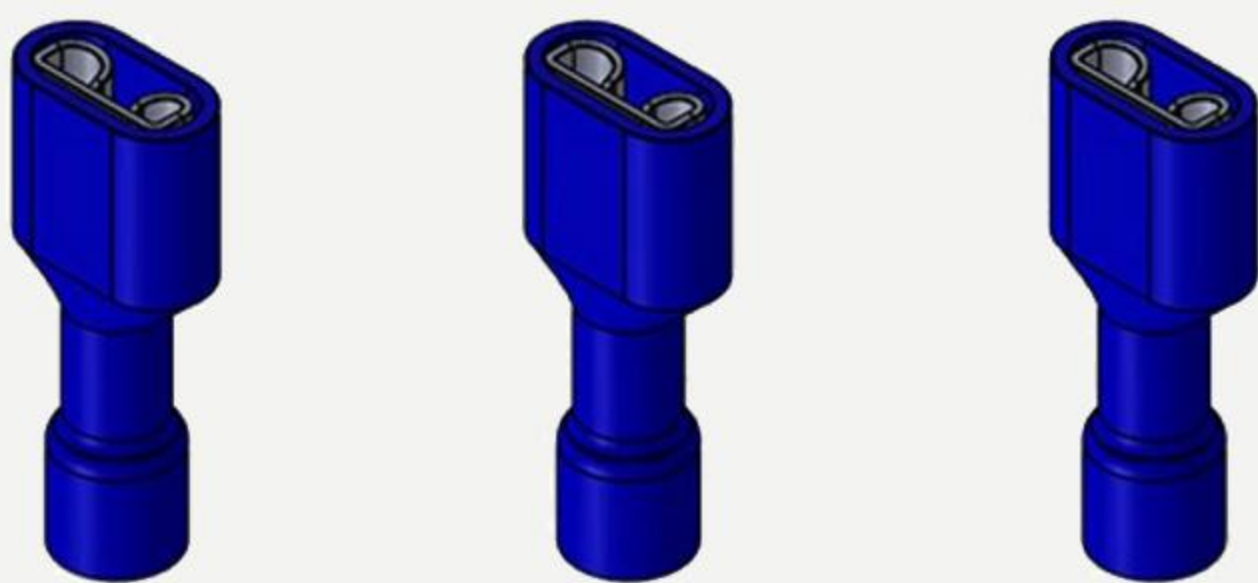

BLUE BLADE TERMINALS

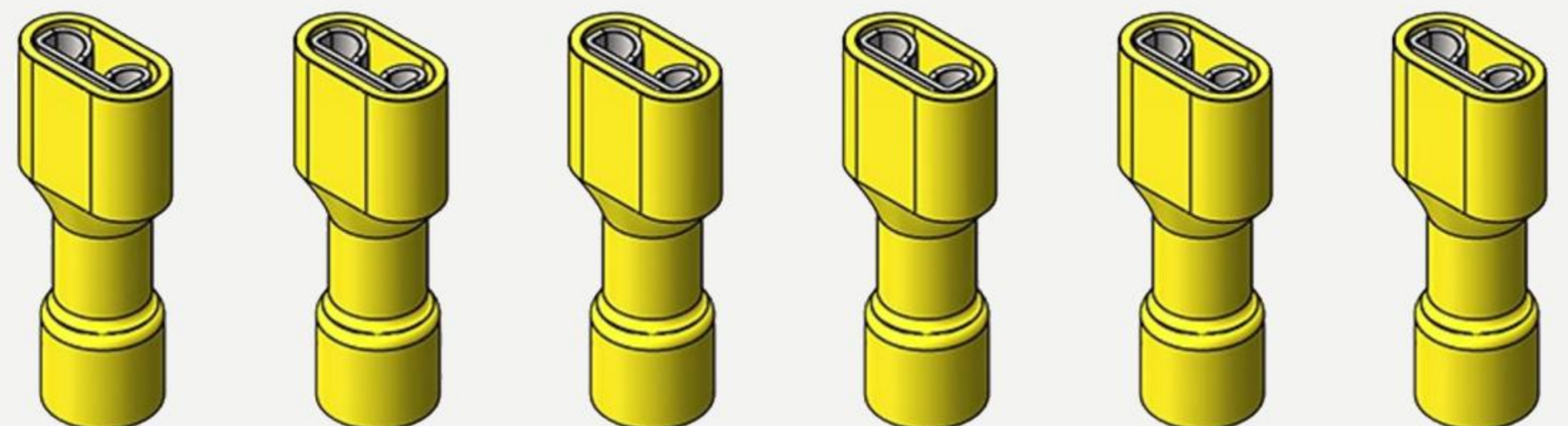

YELLOW BLADE TERMINALS



BLUE BLADE TERMINALS

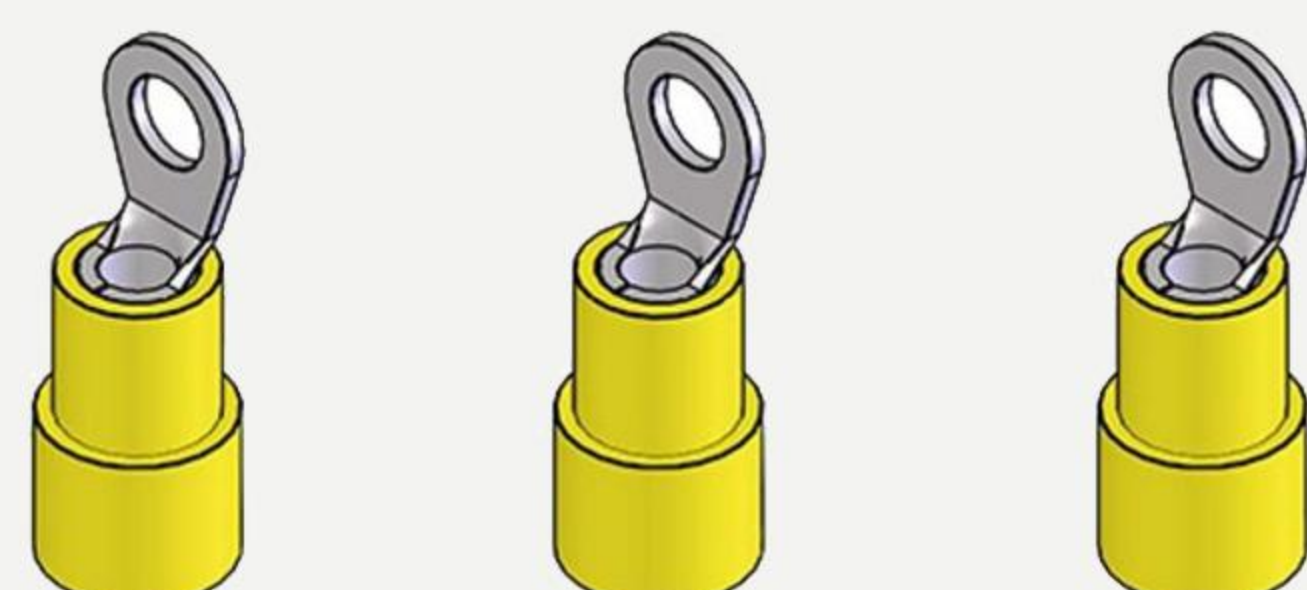

YELLOW RING TERMINALS



# FEATURES

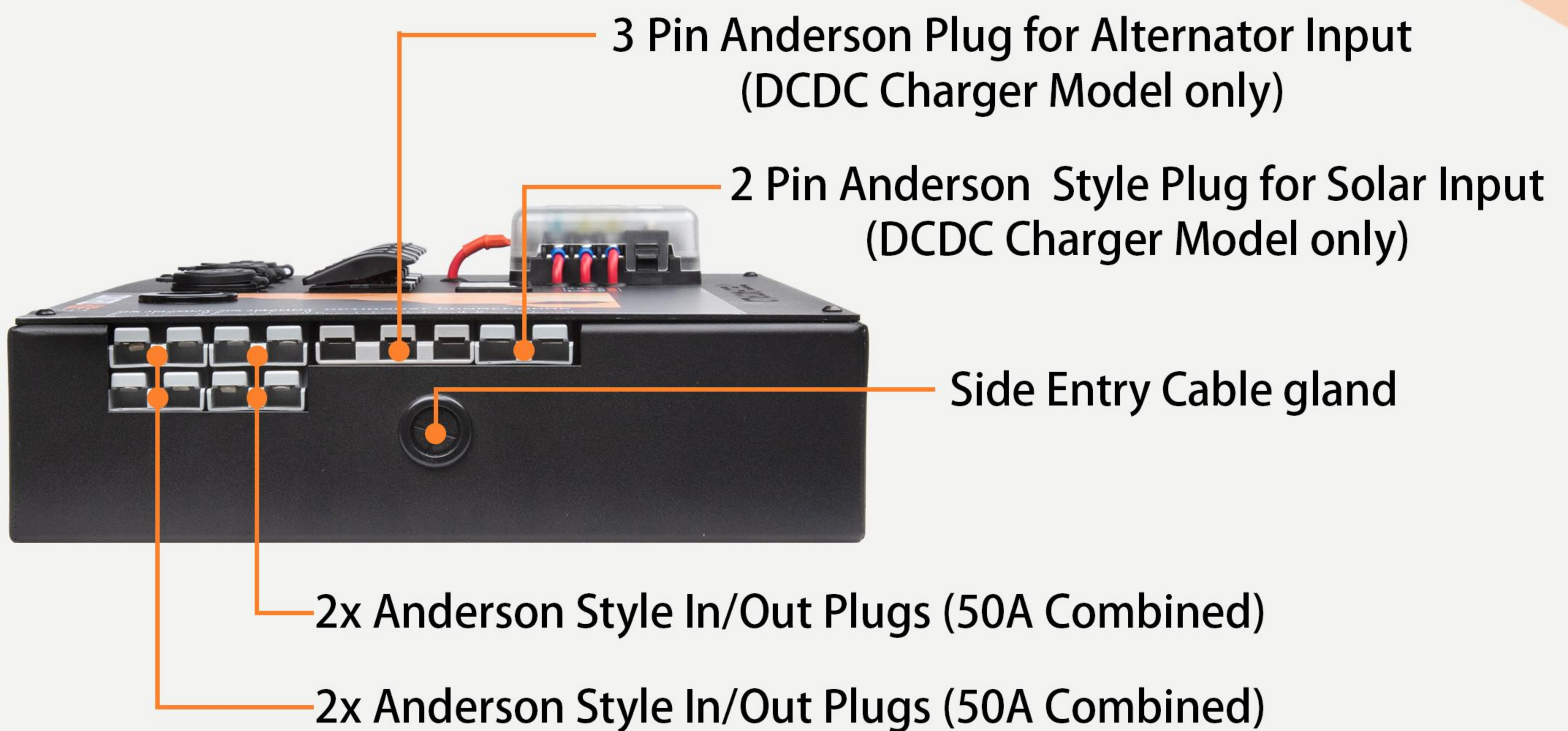
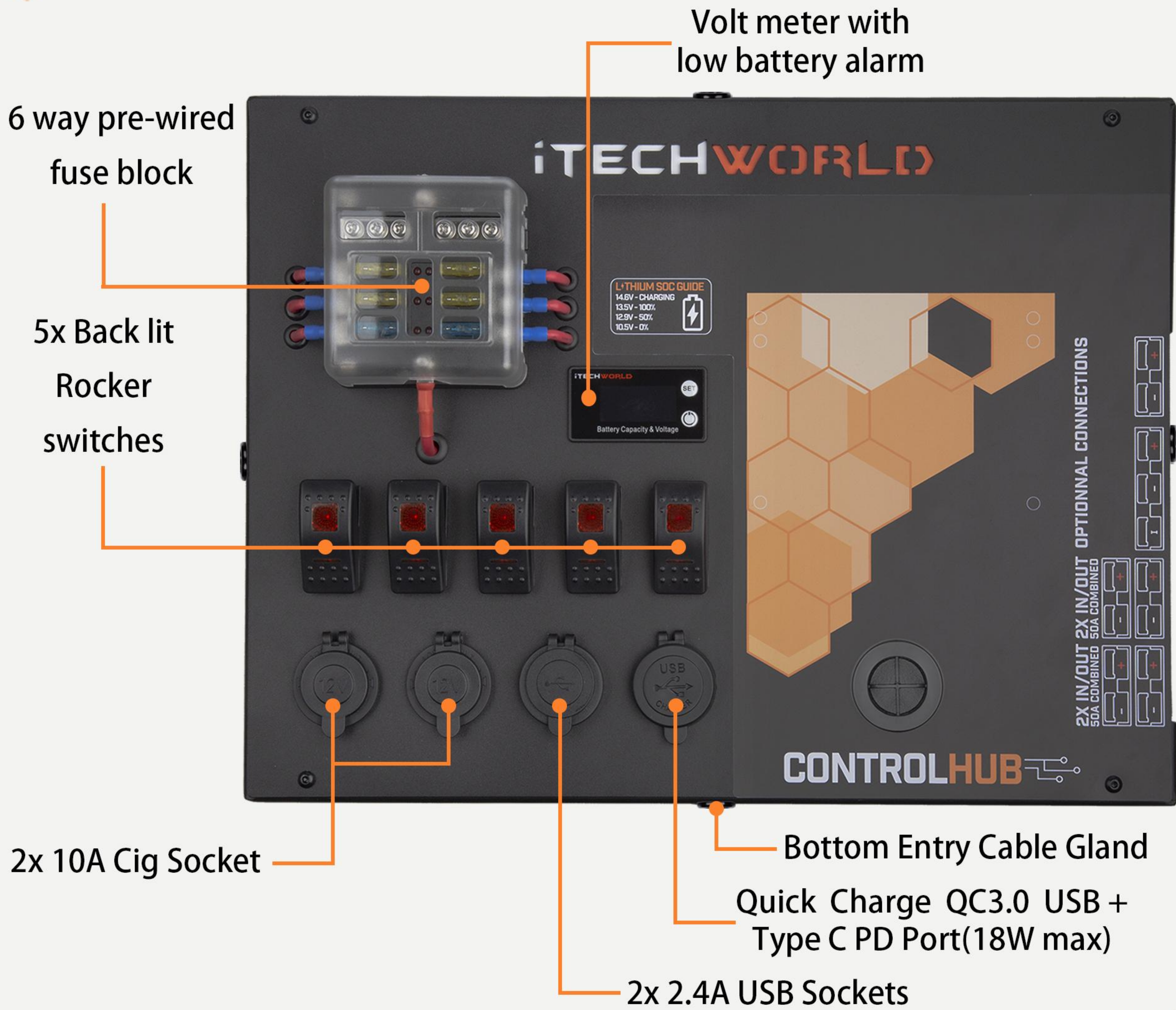



# WIRING DIAGRAM

## WIRING WITH DCDC CHARGER

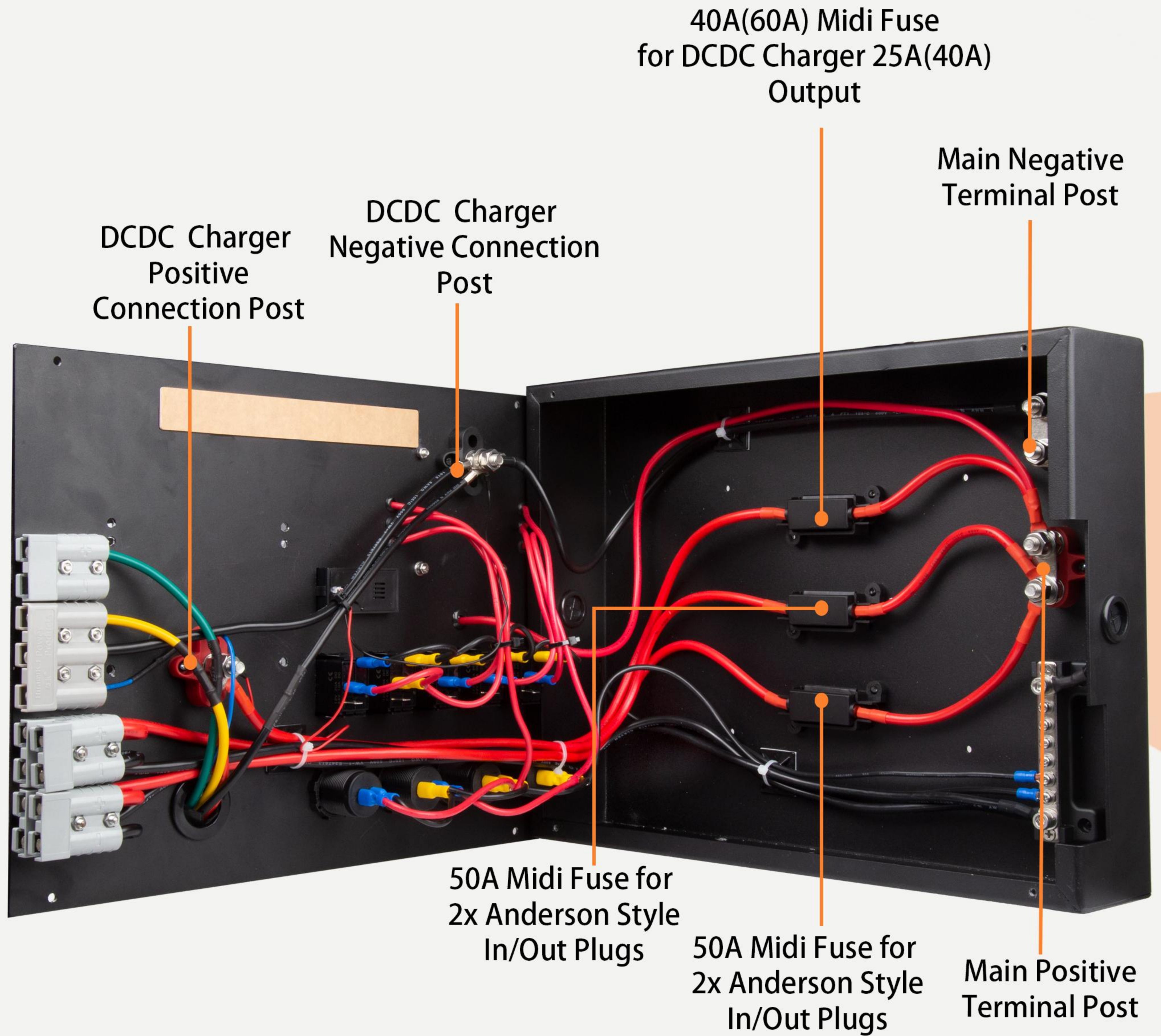



## WIRING WITHOUT DCDC CHARGER

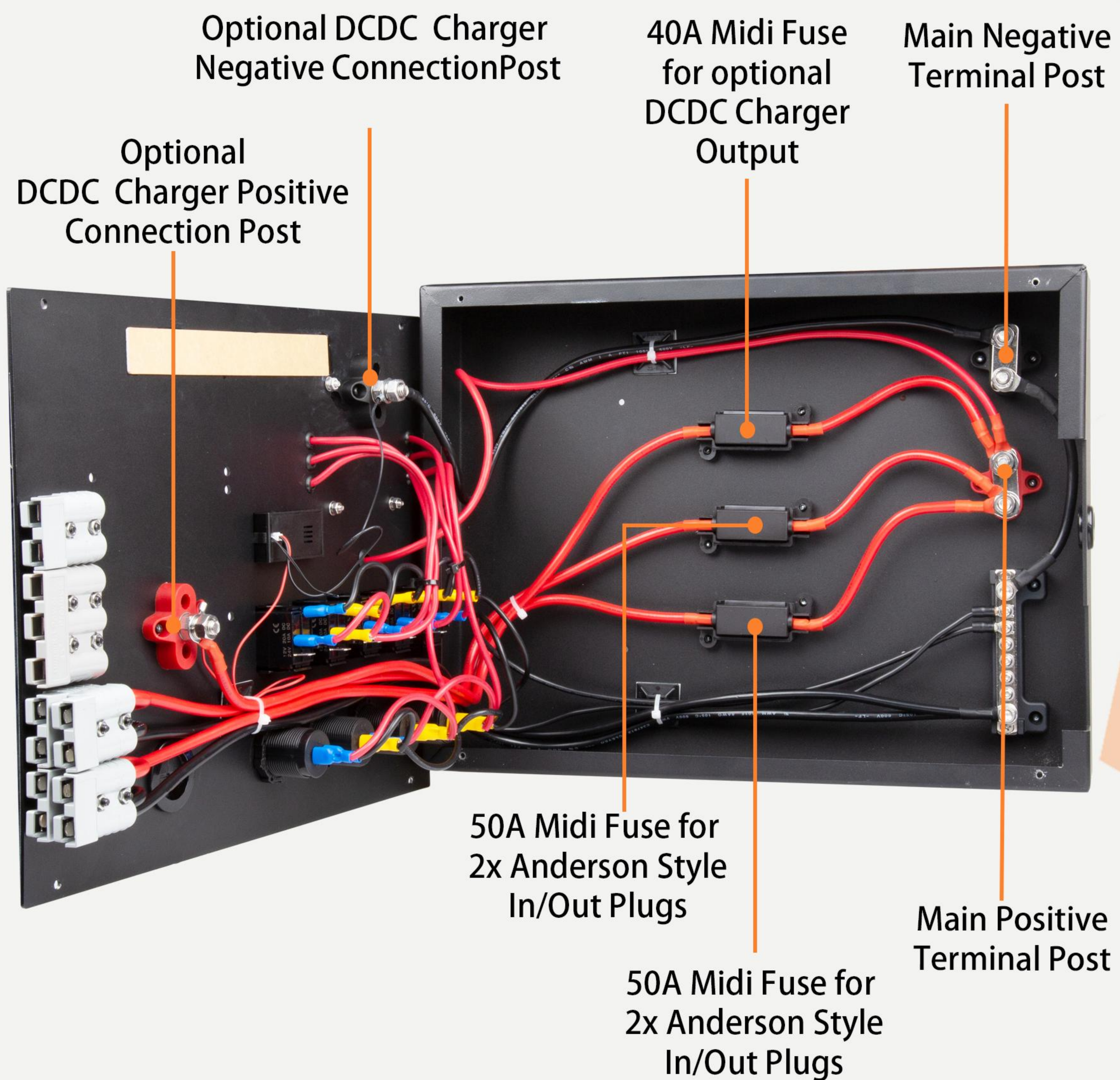



# CONNECTIONS & ACCESSORIES

## Voltmeter

The inbuilt voltmeter will display the voltage of your battery, this can be turned on and off using the little switch on the unit. For an accurate voltage reading, disconnect all loads and charging sources from the control hub and test. The voltmeter is equipped with an audible low battery alarm that activates when the voltage below 11.5V. To mute this alarm, simply turn the voltmeter off or connect a charging source.

Note : The battery voltage table on the sticker of the control hub is to be used as a guide for SOC only, check your battery specifications for accuracy.





# OUTPUTS

## USBs

- 2x 2.4A High Powered USB (White)
- 1x Quick Charge QC 3.0 Ultra high powered usb output (5V/3.1A, 9V/2A, 12V/1.5A) (Orange)
- 1x USB-C PD Port (18W Max)



## Cigarette Sockets

- 2x Cigarette socket output - maximum 10A per socket





## Switches

### 5x 20A Backlit Rocker Switches

- Easy DIY install to hard wire all your camp accessories
- Included stickers to identify the purpose of the switch
- Each switch is fused with a 20A Fuse

Note: Switches 1 and 2 share a 20A fuse so should only be wired with a maximum combined current of 20A



### Warning:

Please consider the wiring size used when fitting your accessories. Wiring installed to power lower rated loads may require the existing fuse to be replaced with a smaller sized fuse.

## INPUTS/OUTPUTS

### 4x (50A) Anderson Style Plugs

- Input/Output power supply - Compatible connection to a charger or load
- Two banks of anderson style plugs protected by Midi fuses
- Each Anderson bank must not exceed a maximum of 50A current



### WARNING:

1. Please check product specifications if connecting multiple charging sources.
2. Do not use an external charger while the DC-DC Charger is operating.
3. Exceeding 50A combined current rating on one Anderson bank will blow the fuse. The fuse will need to be replaced with the spare provided.



# FUSE BOX

## 6x Fuse Box

- Prewired for simplicity
- Blown fuse indicator

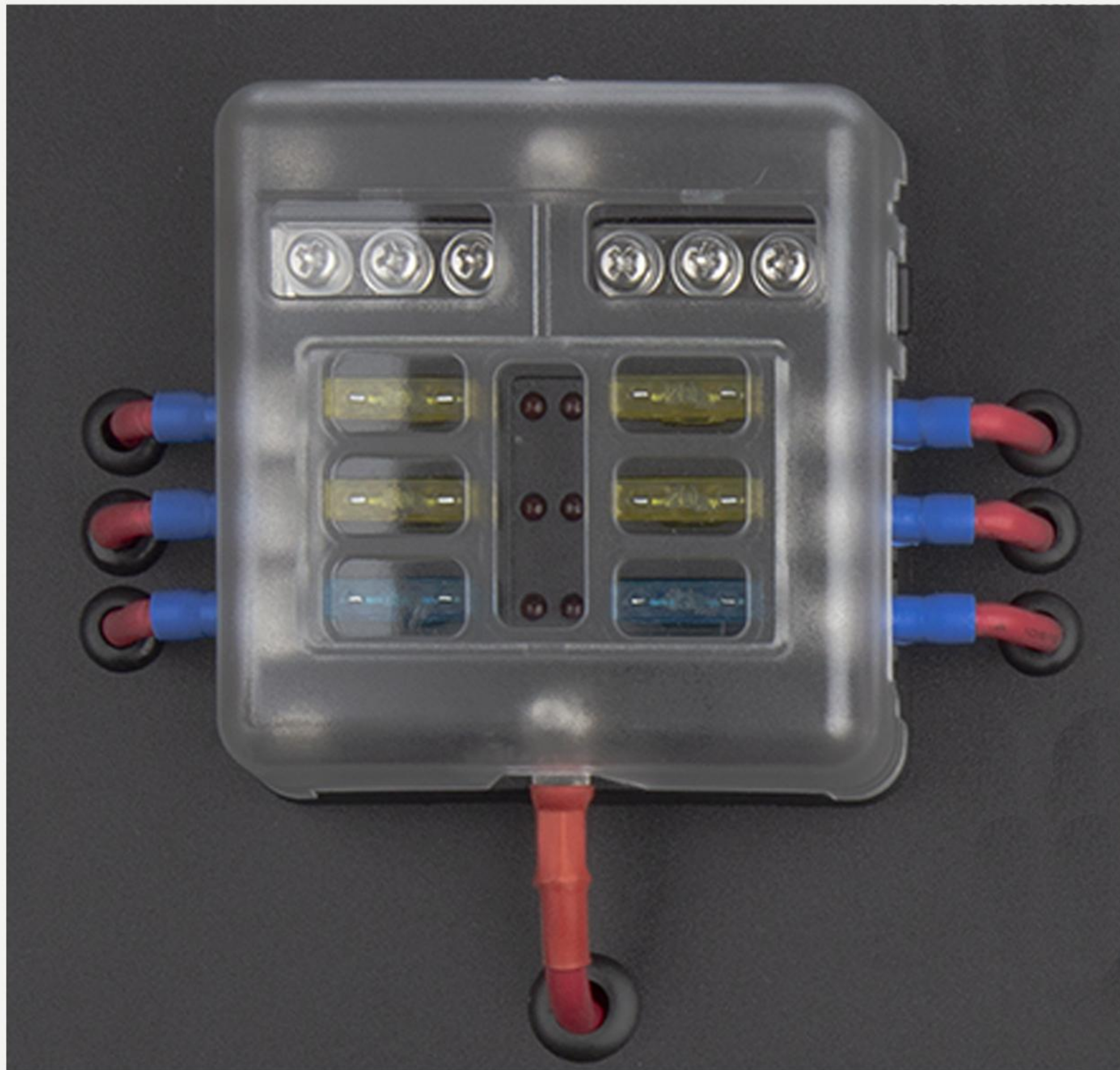

# SWITCH LIGHTING

## Configuration :



SWITCH  
TURNED OFF



SWITCH  
TURNED ON

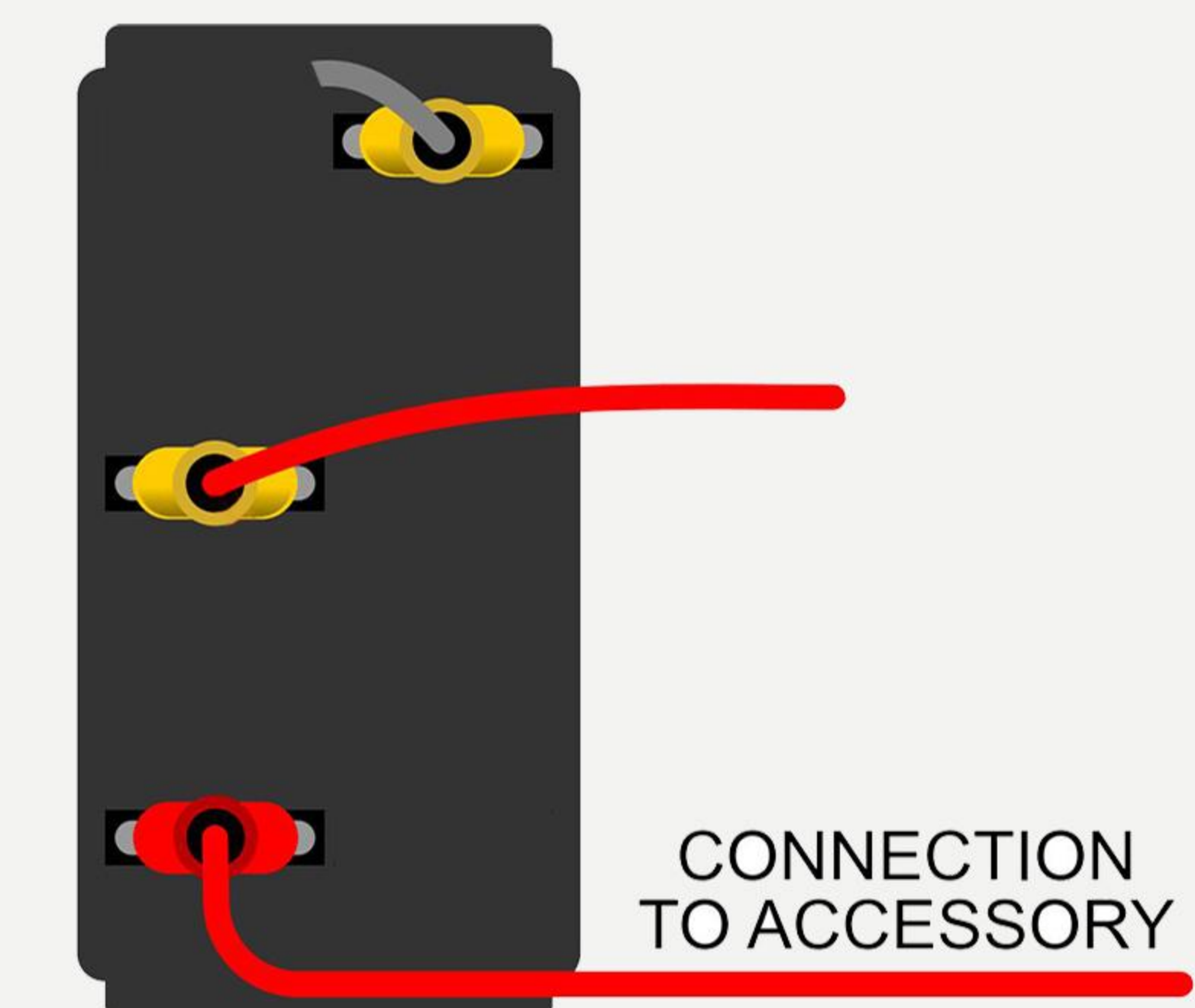

WIRING DIAGRAM



# GETTING STARTED

## MOUNTING INSTRUCTIONS

### What You Will Need



6mm Drill bit

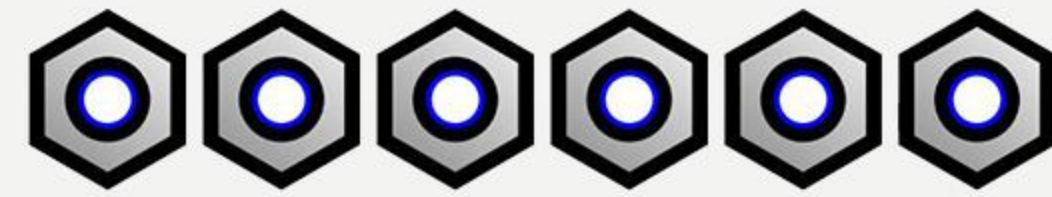

6 x M5 Nyloc Nuts



Spanner  
to tighten nuts  
and bolts

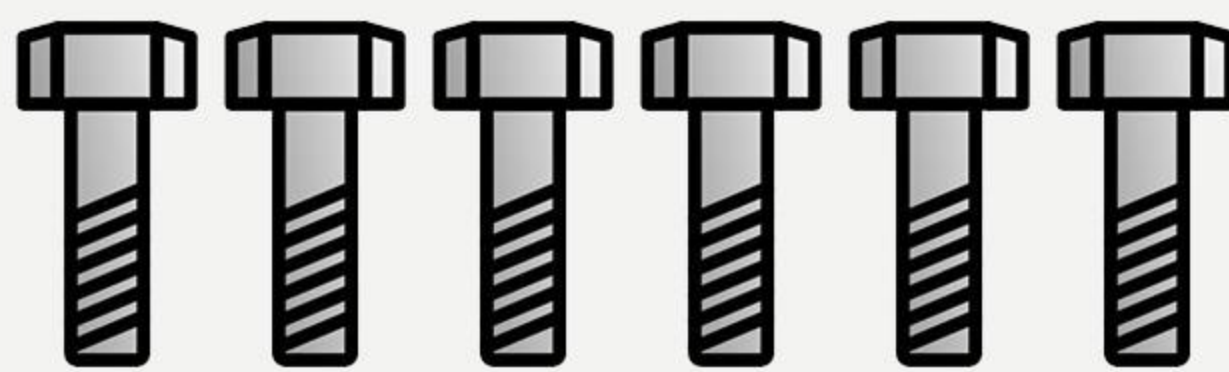

6 x M5 Bolts

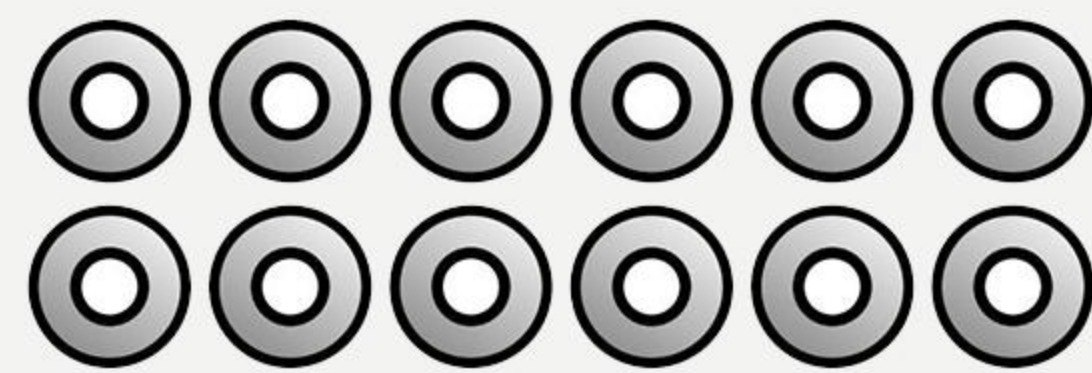

12 x M5 Washers

**Step 1:** Using the supplied allen key, remove the 4 screws and open the Control Hub.



**Step 2:** Ensure all wiring is connected and there are no internal terminals or studs loose.





**Step 3:** Locate the position in your vehicle where you will be mounting your control hub. Making your own template, mark the 4 holes on your mounting surface. Lift the control hub into place to ensure these marks align with the 4 pre drilled holes in the control hub

**Step 4:** Using a 6mm drill bit, drill through the 4 premarked holes on your mounting surface. *Note: if mounting on a metal surface you may need to use a smaller pilot hole or step drill.*

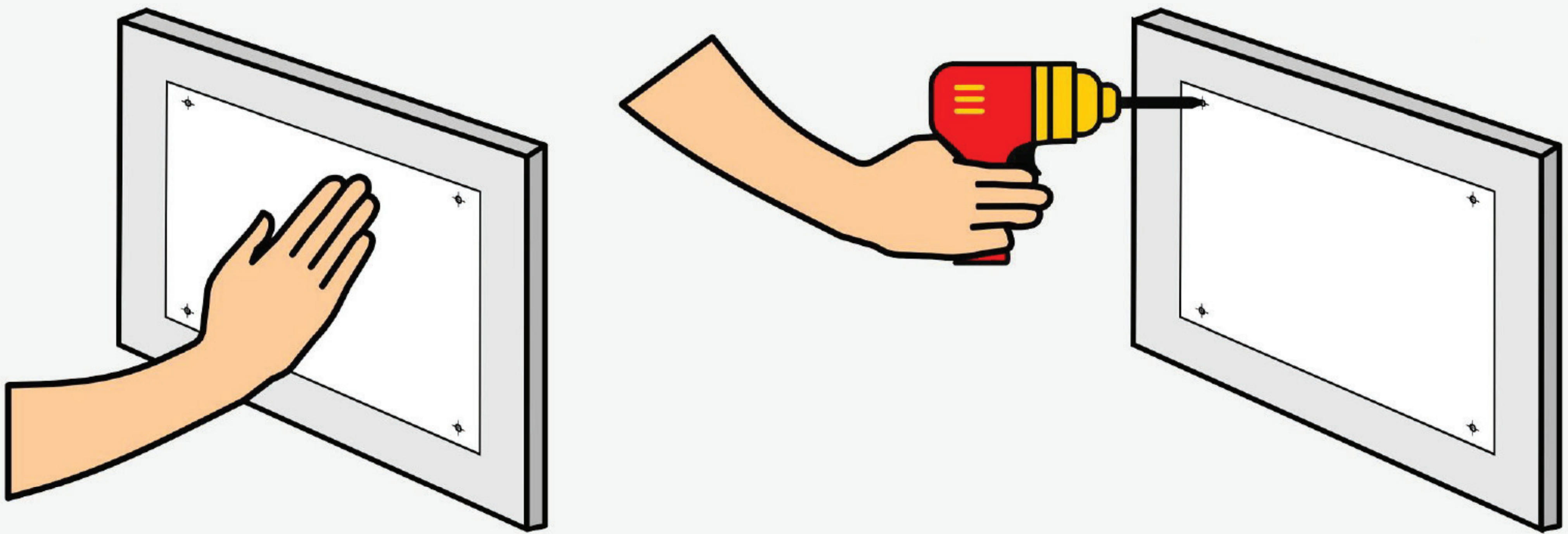

**Step 5:** Lift the control hub into position and insert the 4 bolts and washers into the pre drilled holes. Secure with a nut and washer on the rear. Tighten with a spanner until secure.

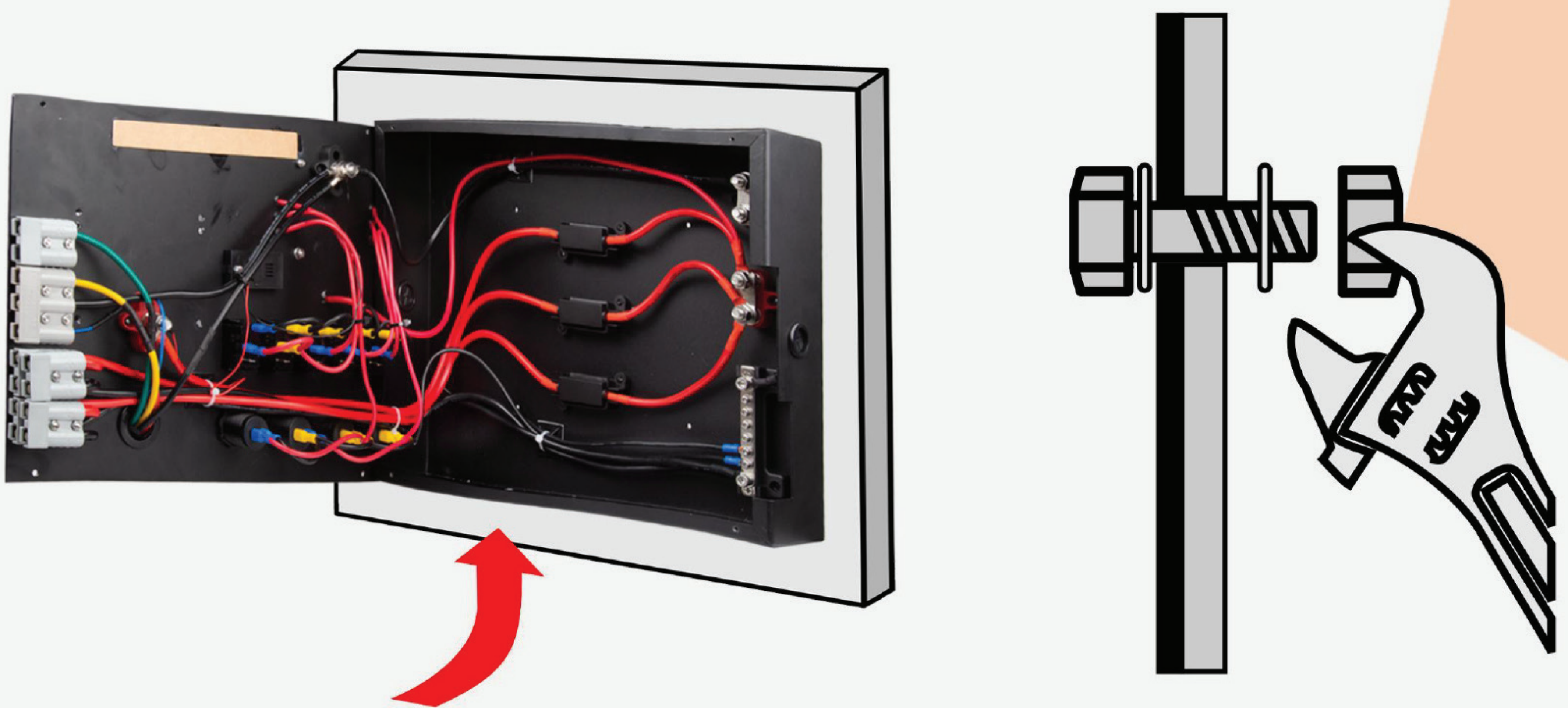



# WIRING INSTRUCTIONS

The unit comes fully assembled and ready to use. The following instructions are for wiring in the 5 switches and connecting the unit to your battery

## WIRING IN SWITCHES

### What You Will Need

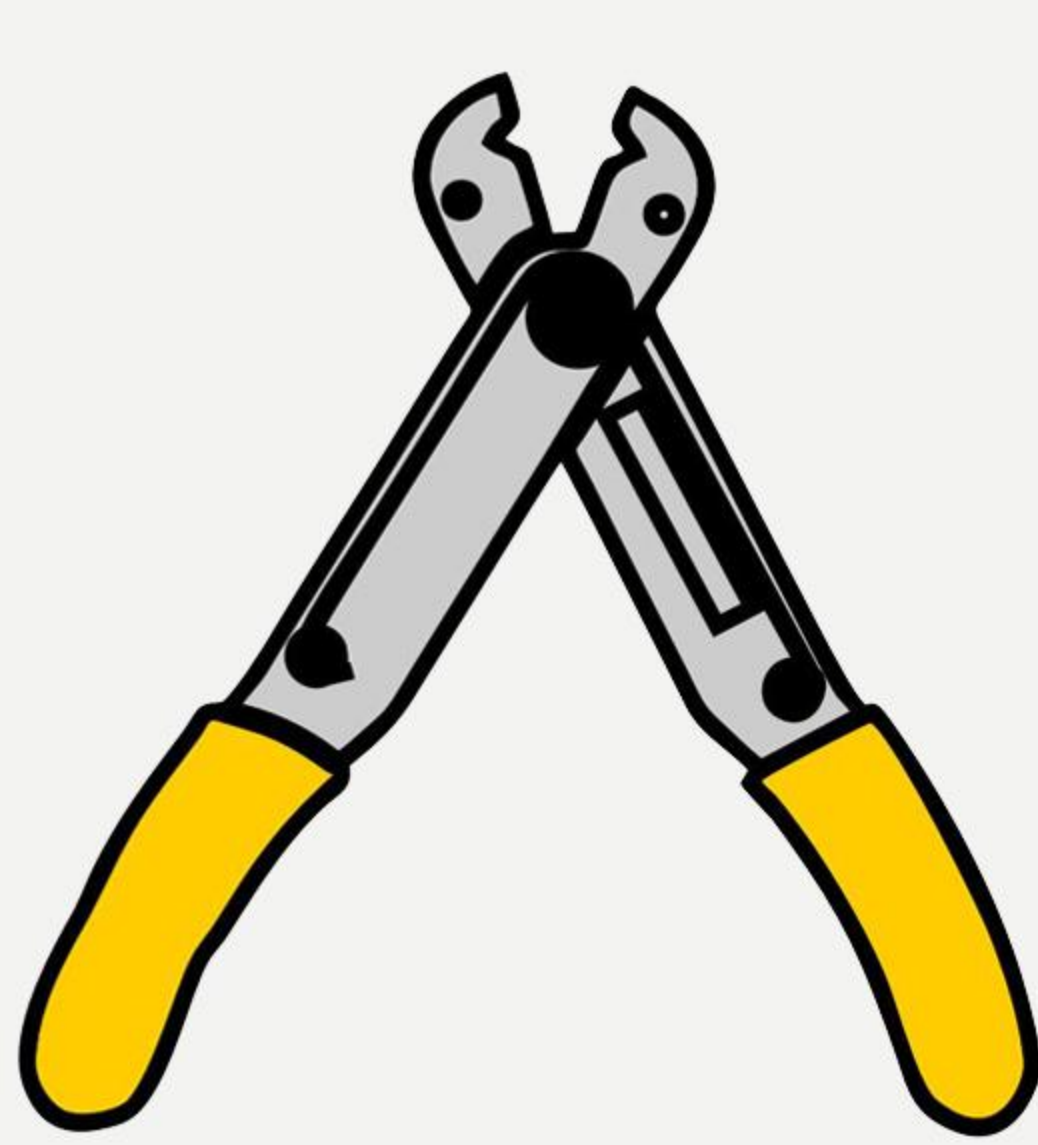

Wire Crimper

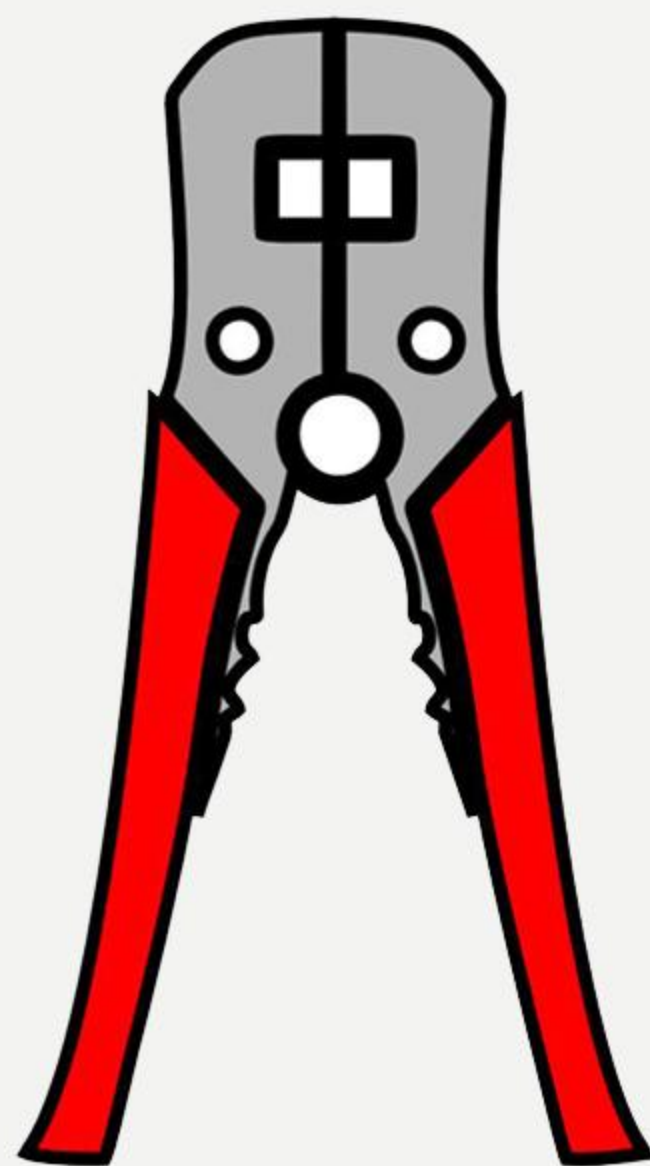

Wire Stripper

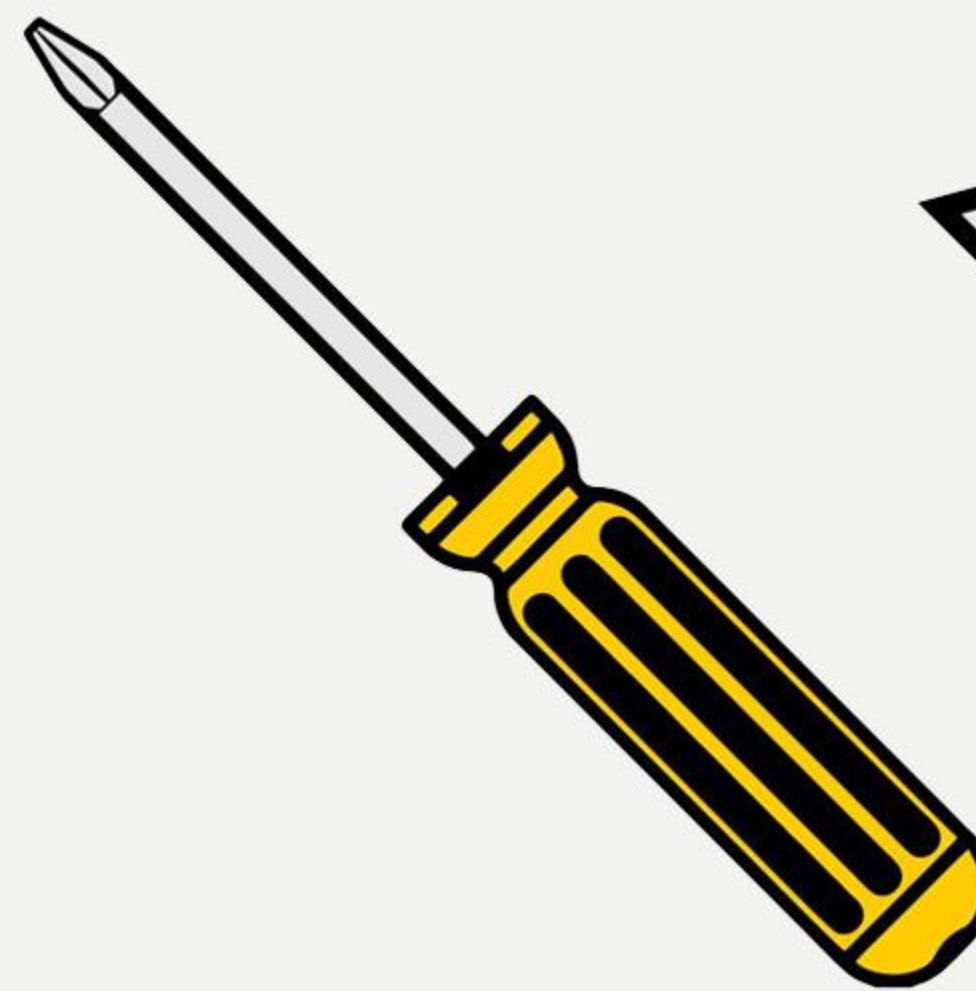

Phillips Head  
Screwdriver

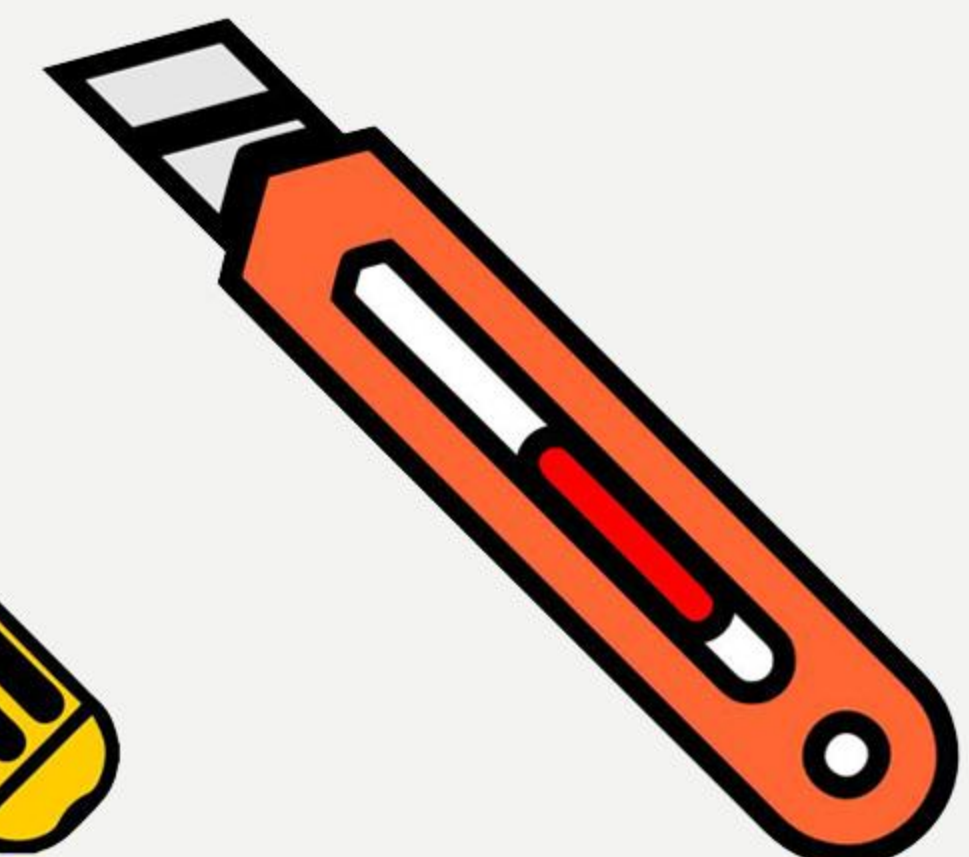

Utility Knife

*Note: Ensure the unit is disconnected from the battery prior to attempting any wiring*

**Step 1:** Using the supplied allen key, remove the 4 screws and open the Control Hub

**Step 2:** For wiring in switches, select the appropriate sized spade and ring terminal for your accessories wiring.

*Note:* The yellow terminals are recommended for use with 10-12AWG wire and the blue terminals are recommended for use with 12-14AWG wire.

**Step 3:** Using a knife, cut the grommets on the side or bottom of the unit that your accessory wires will run through. Push approximately 30cm of your accessories wiring through the grommet

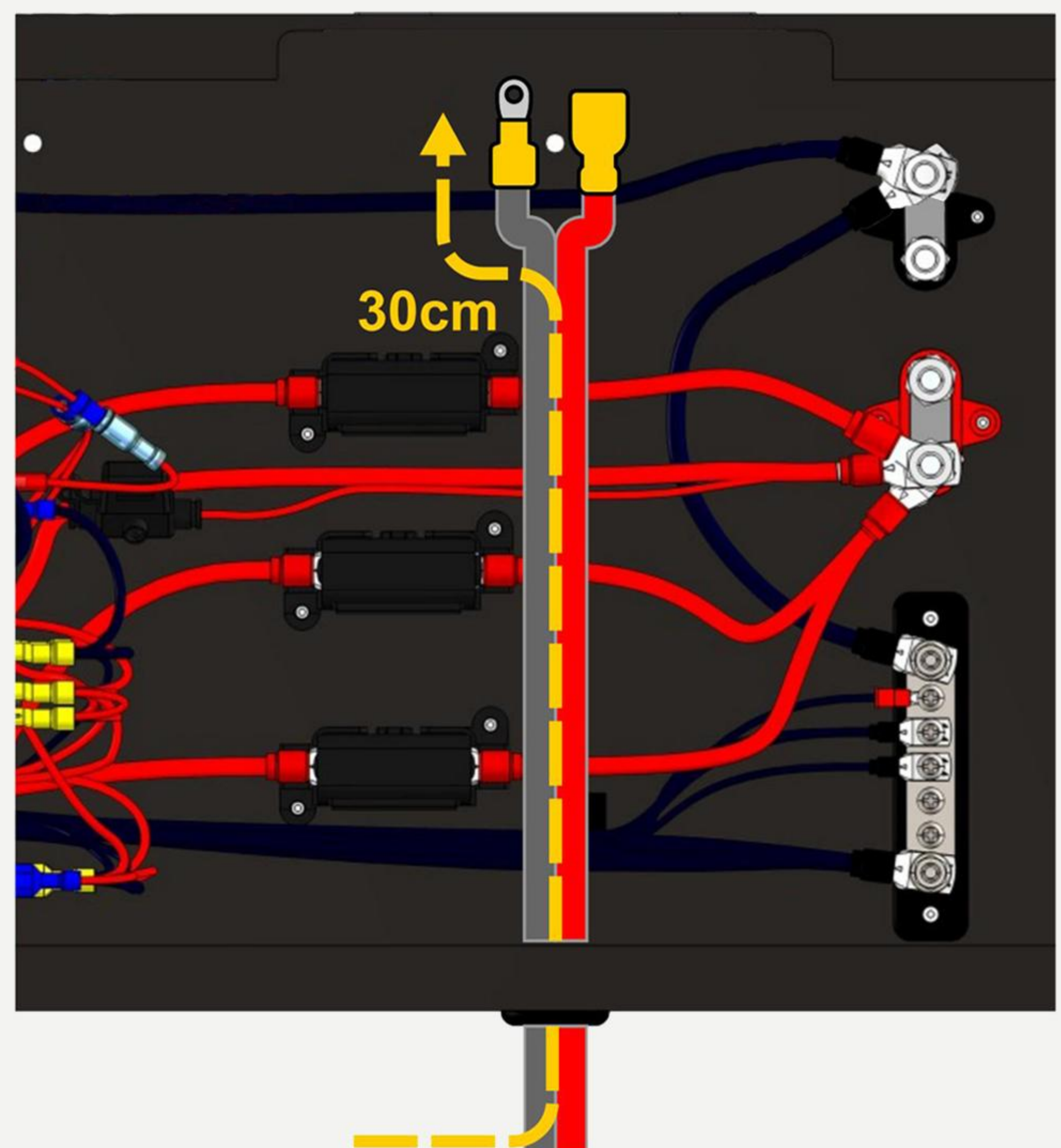



**Step 4:** If your wiring is dual core, separate approximately 30cm of the two wires.

*Note: You may need to remove the 30cm of the outer layer of insulation if your wire is double insulated*

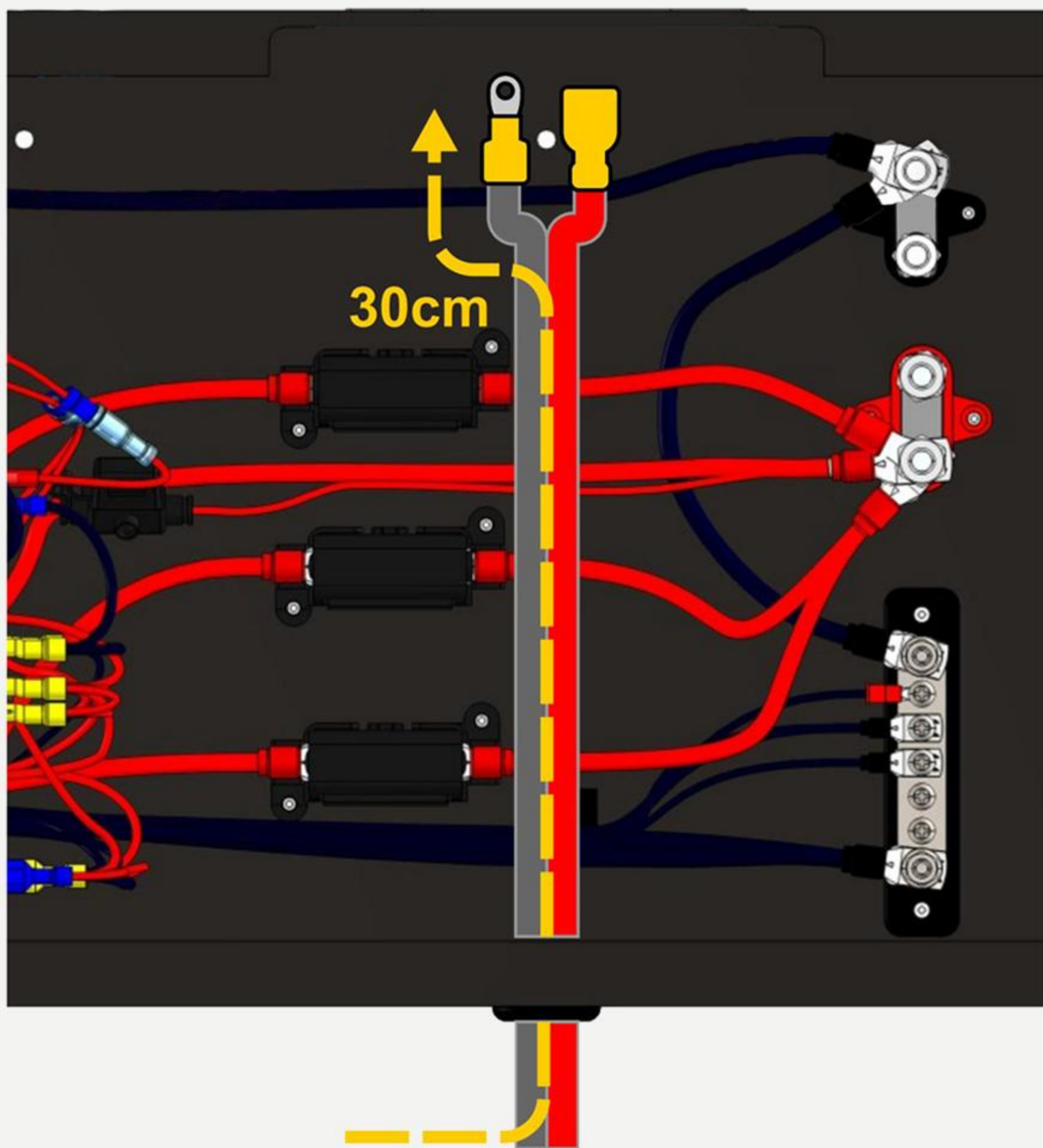

**Step 5:** Strip approx 1cm of insulation from each cable using a wire stripper, select and crimp the appropriate sized spade terminal to your positive wire and the ring terminal to the negative wire. Note: Check with the manufacturer of your accessory to determine which wire is positive and which is negative crimping terminals.

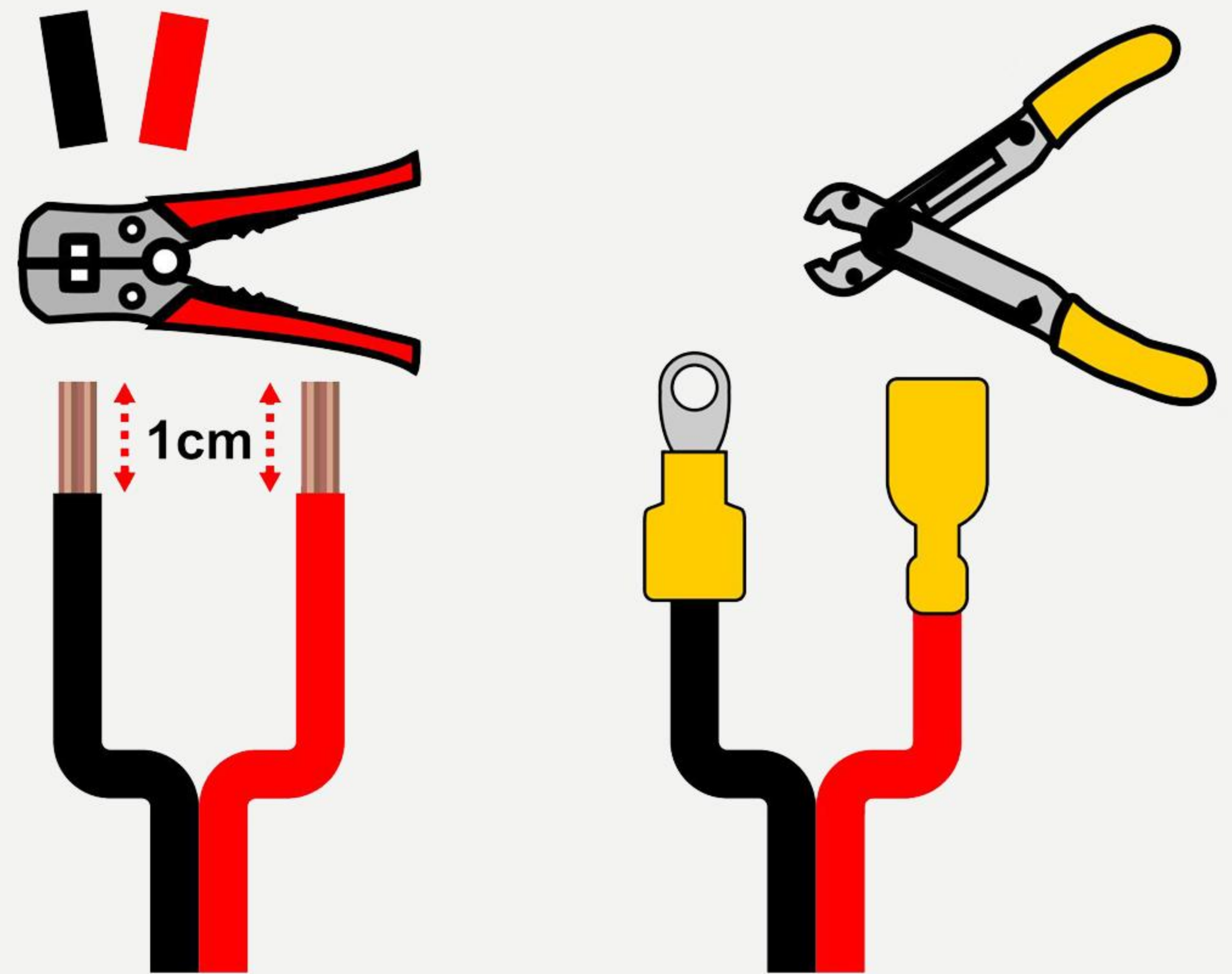

**Step 6:** Connect the spade terminal to the bottom blank tab on your switch and using a phillips head screwdriver, connect the negative ring terminal to one of the spare screw positions on the negative bus bar.

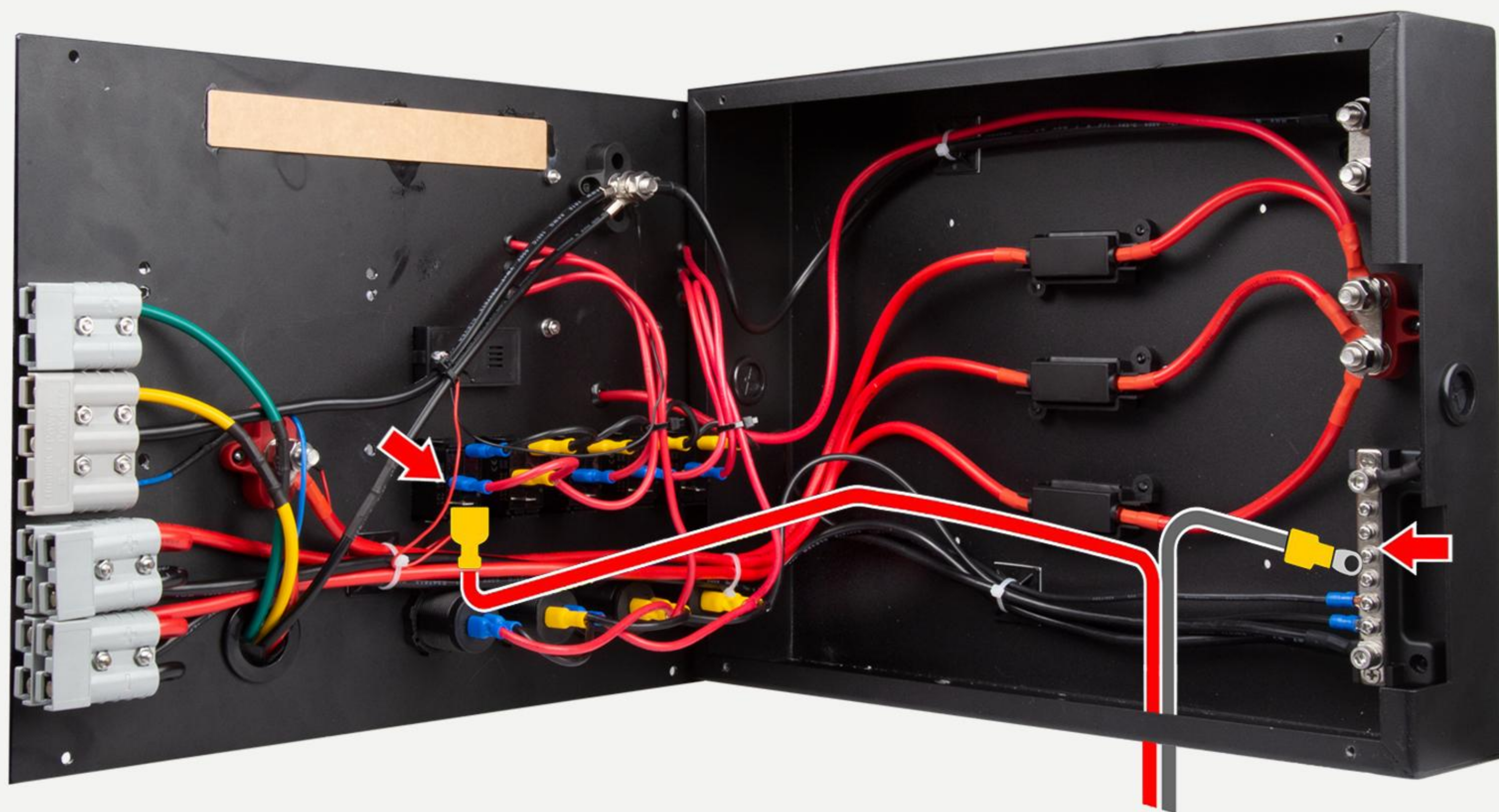

**Step 7:** Tuck cables neatly under the control hub and carefully close the lid, returning the 4 screws to secure the control hub down





# CONNECTING TO BATTERY

## What You Will Need

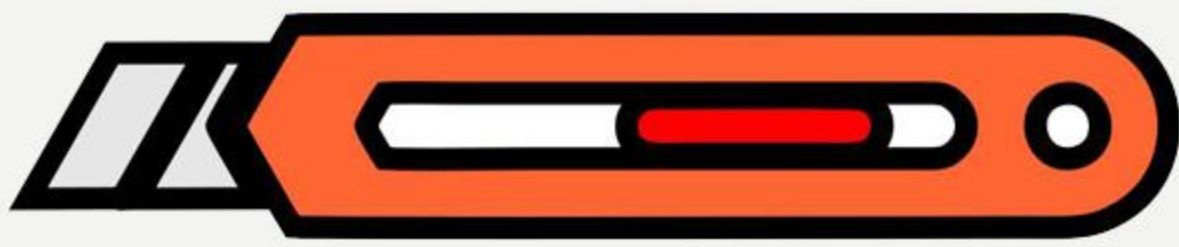

Utility Knife

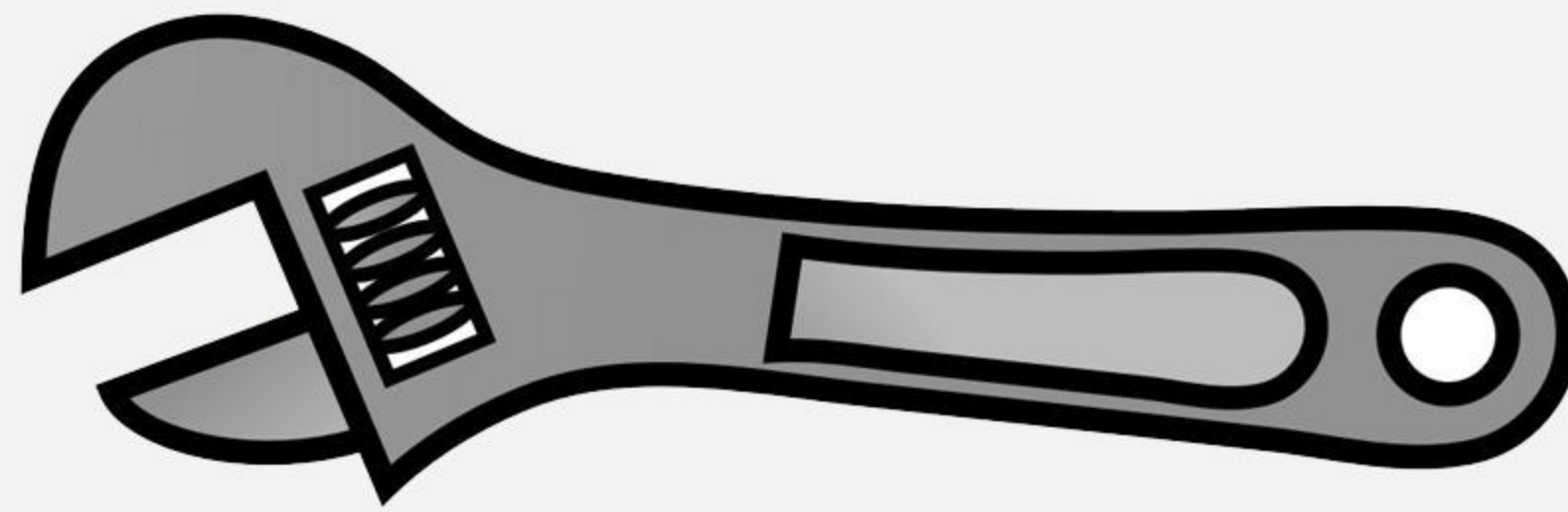

Adjustable Spanner

**Step 1:** Using the supplied allen key, remove the 4 screws and open the Control Hub



**Step 2:** Using a knife, cut the grommets on the side or bottom of the unit that your battery wires will run through. Push approximately 30cm of the included battery wire through the grommet

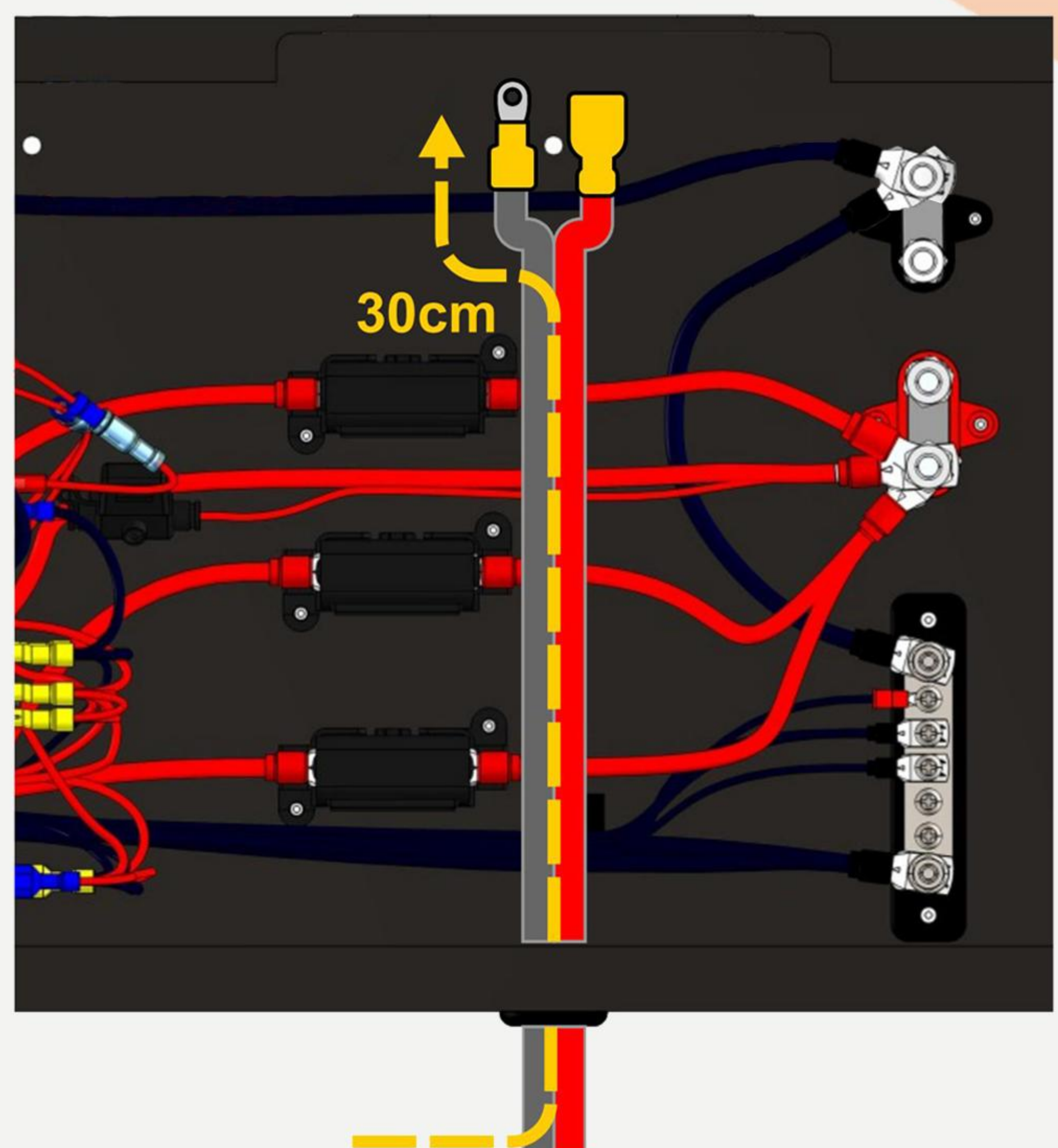



**Step 3:** Using the spanner, remove the bolt and washer off both the positive (red) and negative (black) terminal posts on the rear of the control hub.

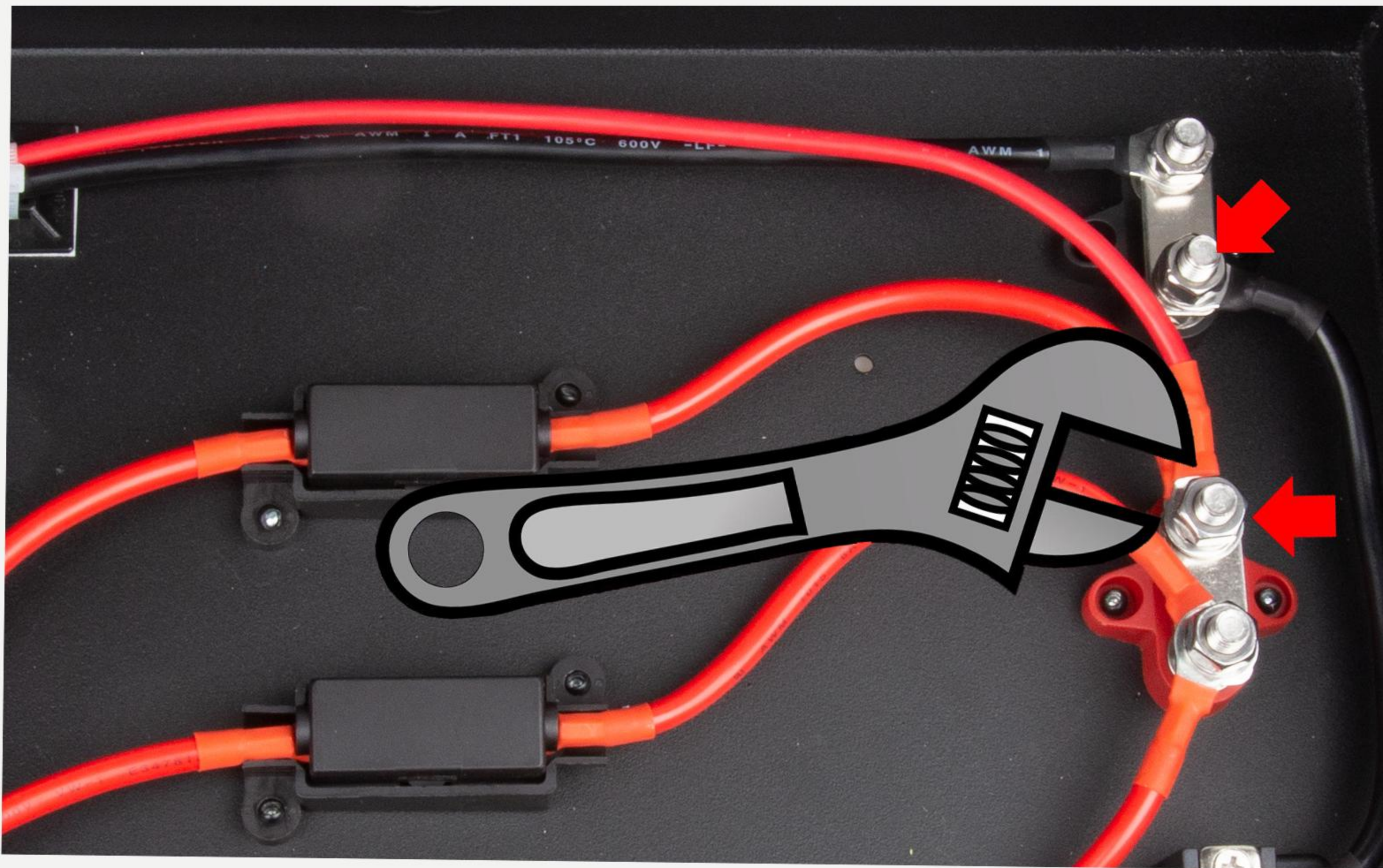

**Step 4:** Attach the wire with the black terminal cover to the negative (black) terminal post and the wire with the red terminal cover to the positive (red) terminal. Replace the nut and washer and retighten with a spanner. Note: Ensure the wires are not connected to the battery

*Note: Use cable ties to fix them in place*

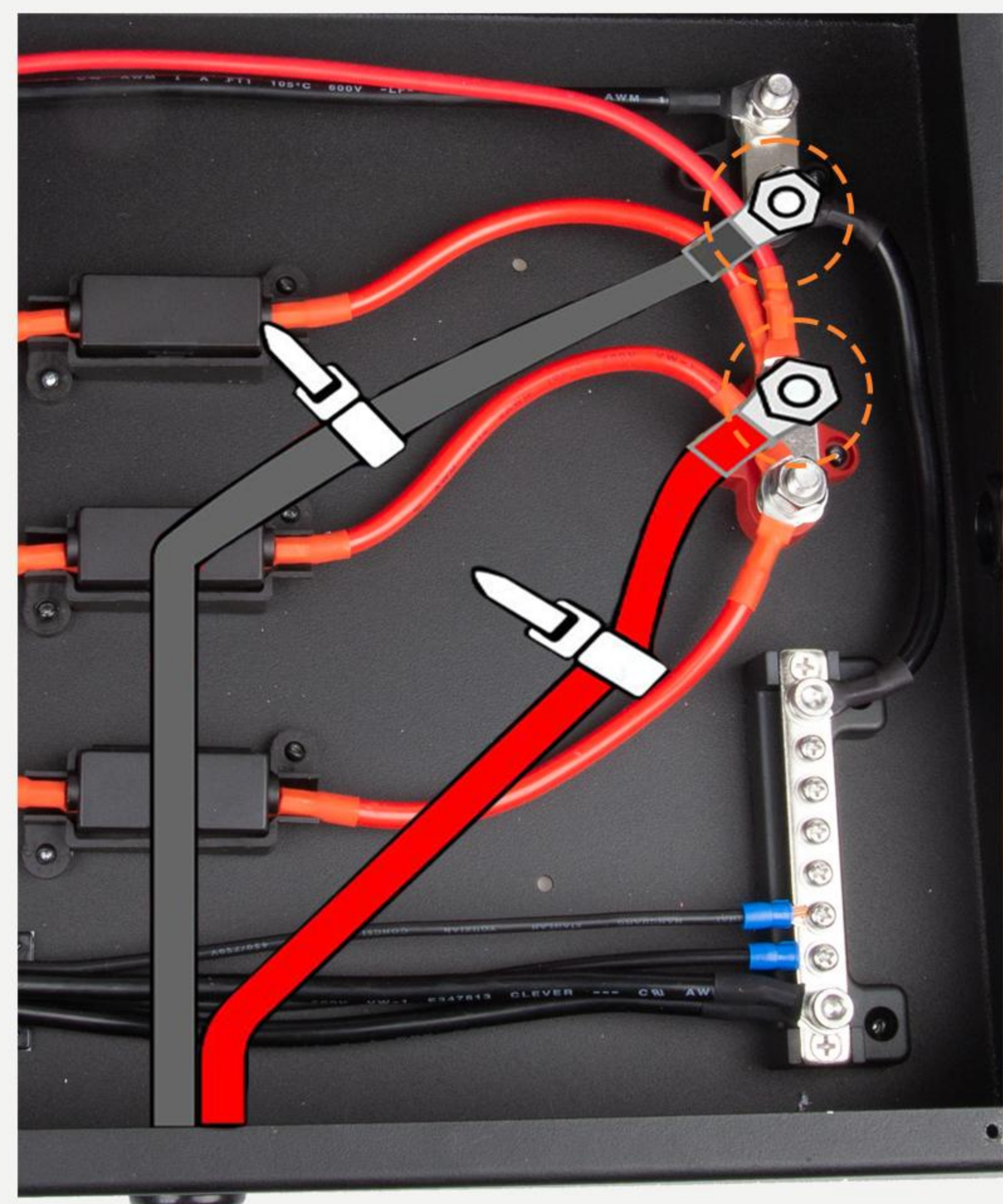

**Step 5:** Tuck cables neatly under the control hub and carefully close the lid, returning the 4 screws to secure the control hub down





**Step 6:** Connect the other end of the wires to the battery by first attaching the wire with the red terminal cover to the positive (Red) terminal on your battery, and then attaching the wire with the black terminal cover to the negative (black) terminal on your battery

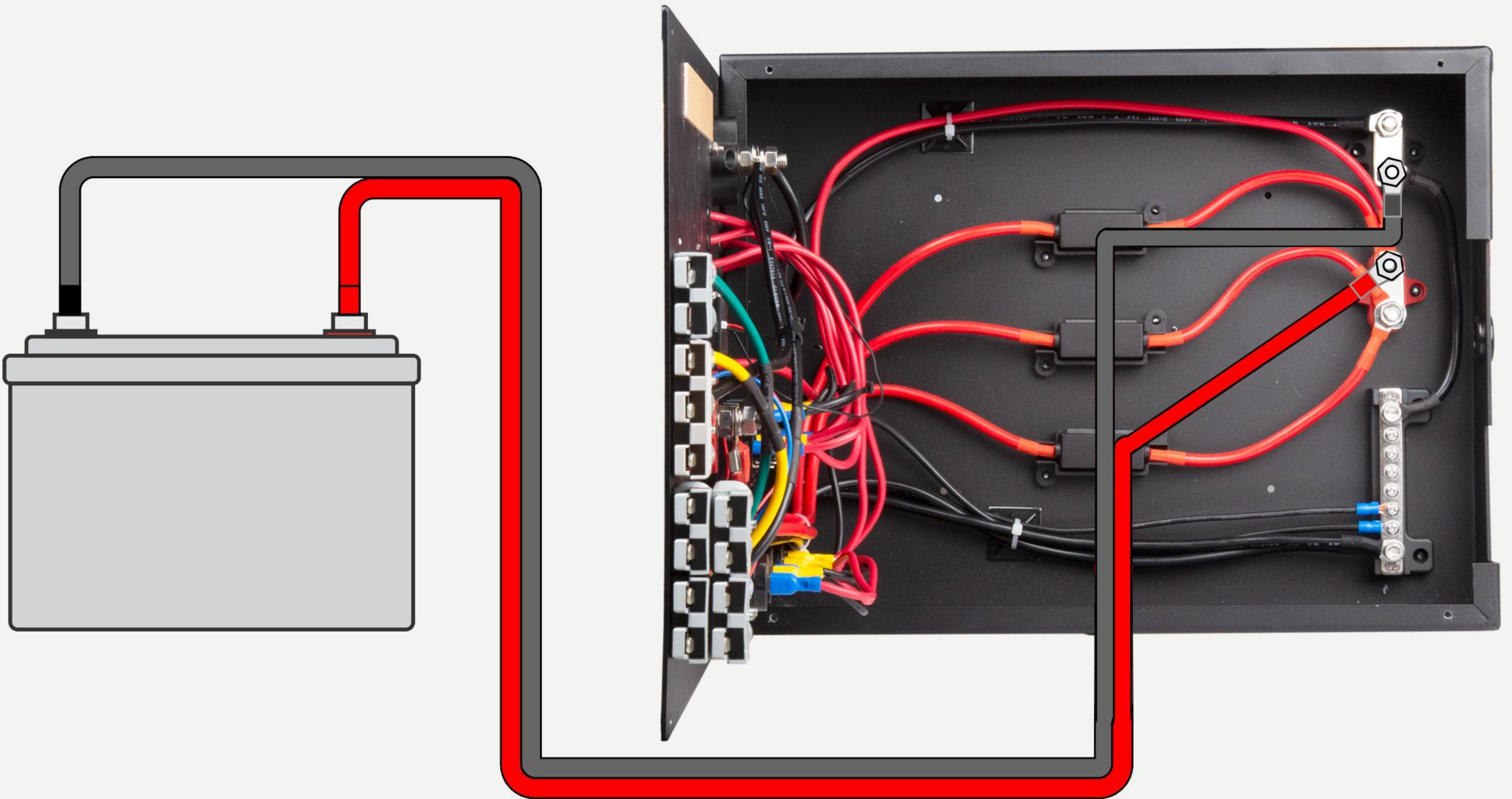

**Step 7:** Ensure cables between the control hub and battery are adequately supported and not prone to rubbing, you may need to use cable ties to fix them in place.

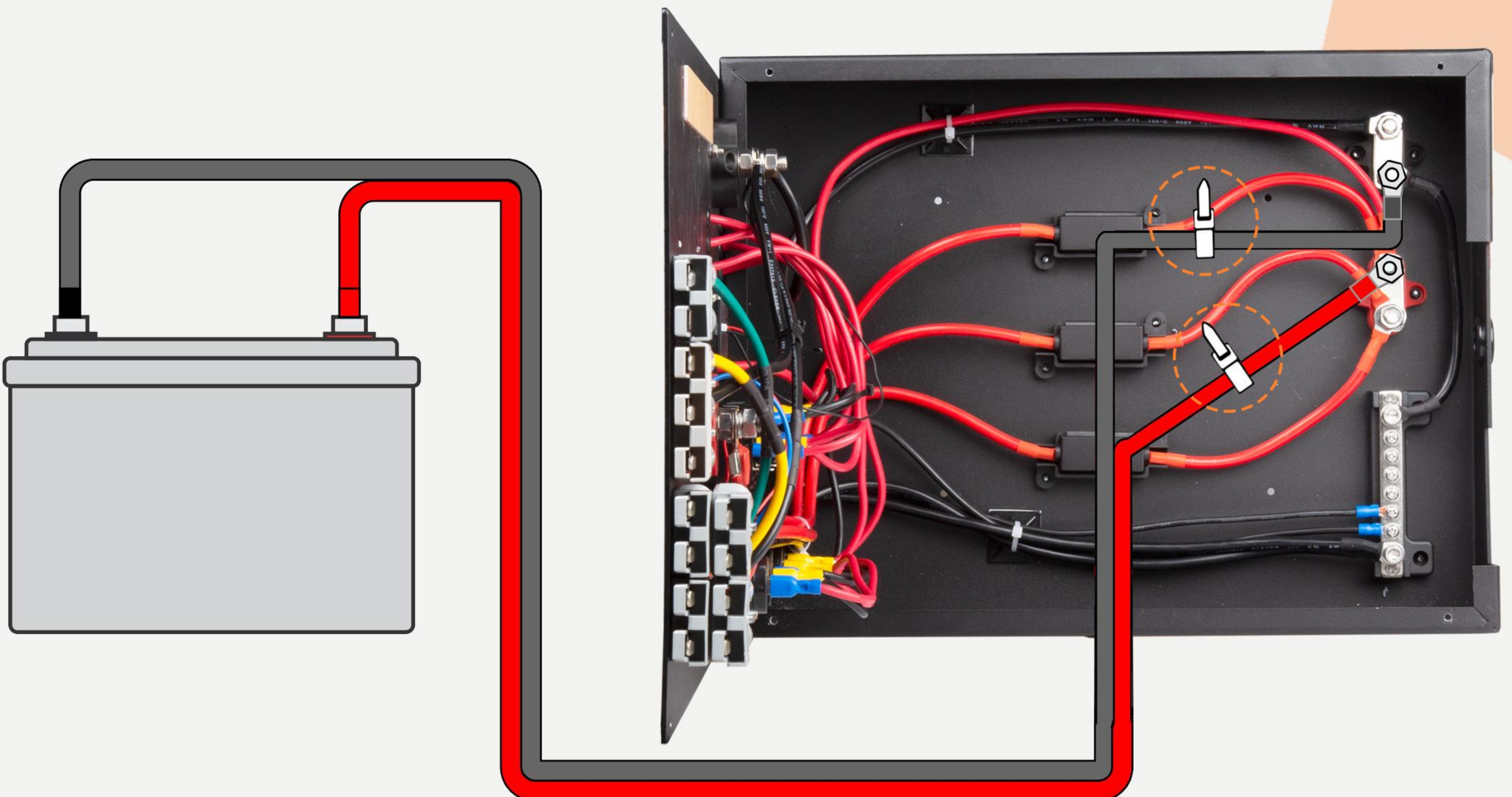



# DCDC CHARGER MODEL

The following information only applies to the itechworld Control Hub fitted with a DCDC Charger. For specific information regarding the operation of the DCDC Charger, refer to the specific charger manual.

## CONNECTING THE DCDC CHARGER (DCDC CHARGER MODEL ONLY)

The itechworld Control Hub includes a built-in DC-DC Charger suitable for charging from a vehicle alternator. The easiest way to connect the control hub to your vehicle is by using the itechworld Plug & Play Wiring Kit (sold separately).

The triple Anderson style connector fitted to the control hub interfaces with the itechworld Plug & Play Wiring Kit, providing a simple, quick release vehicle charging solution. This triple connector and cable provides alternator power to the DC-DC on the control hub, along with an ignition source for charging in vehicles that are fitted with Smart or Temperature Compensating Alternators.

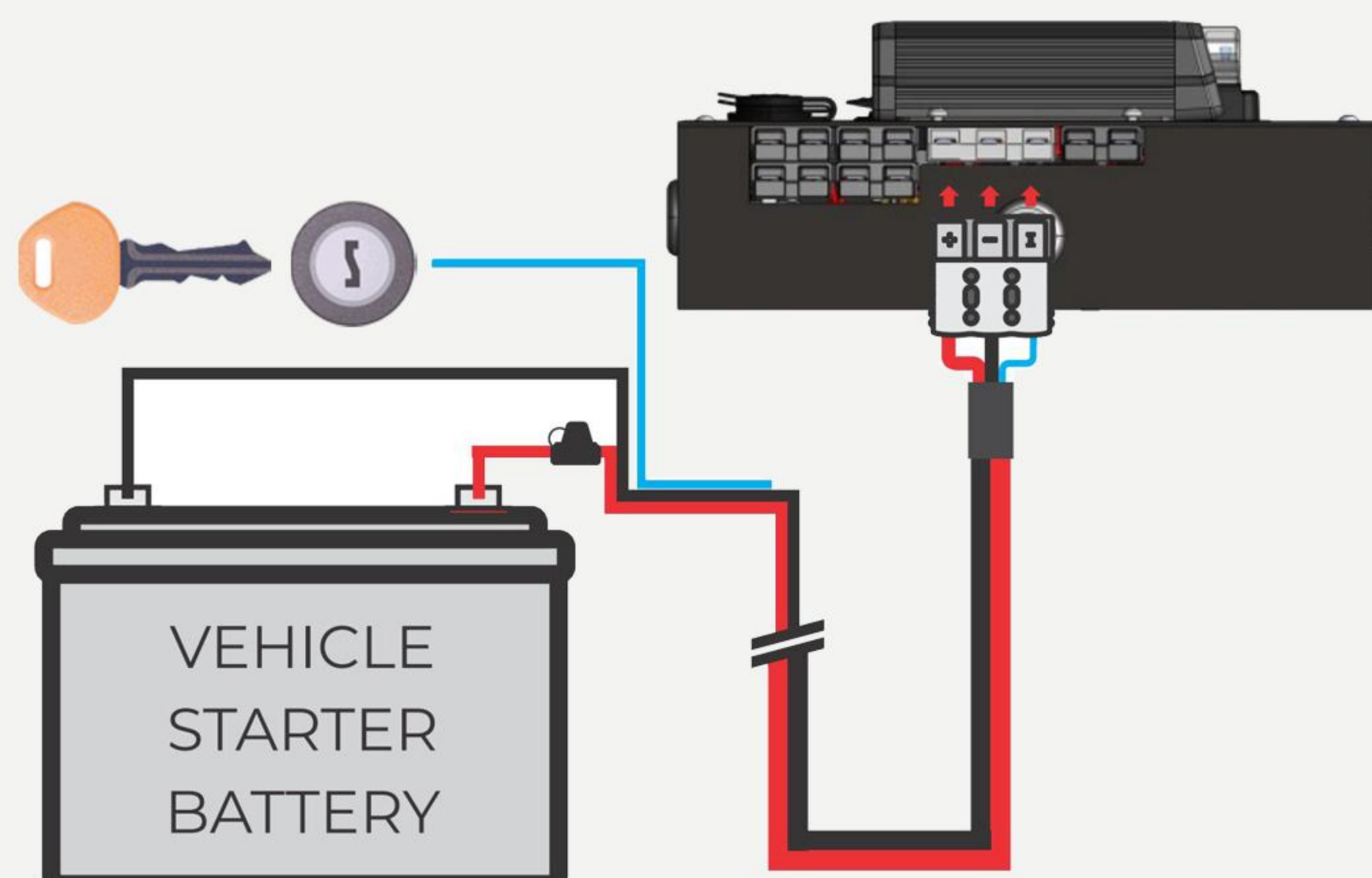
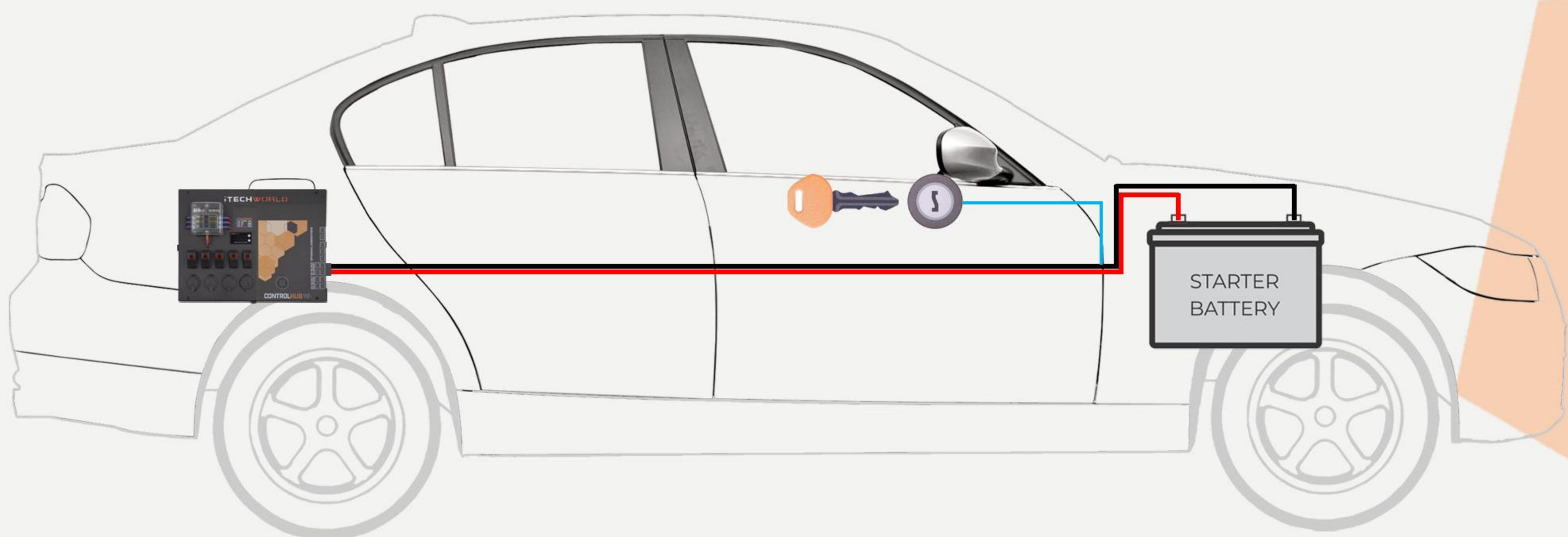



# CONNECTING SOLAR INPUT

itechworld Control Hub includes a built-in DCDC Charger with an MPPT regulator suitable for charging from unregulated solar panels. To connect your solar panel to the regulator simply plug it in via the black anderson plug on your control hub.

## Note:

- Your solar panel open circuit voltage must not exceed 32 VoC, this can generally be found on the sticker on the rear of your solar panel
- If your solar panel is fitted with a built-in regulator, you will need to bypass the regulator port. Alternatively you can connect your regulated solar panel to any of the in/out anderson style connectors.

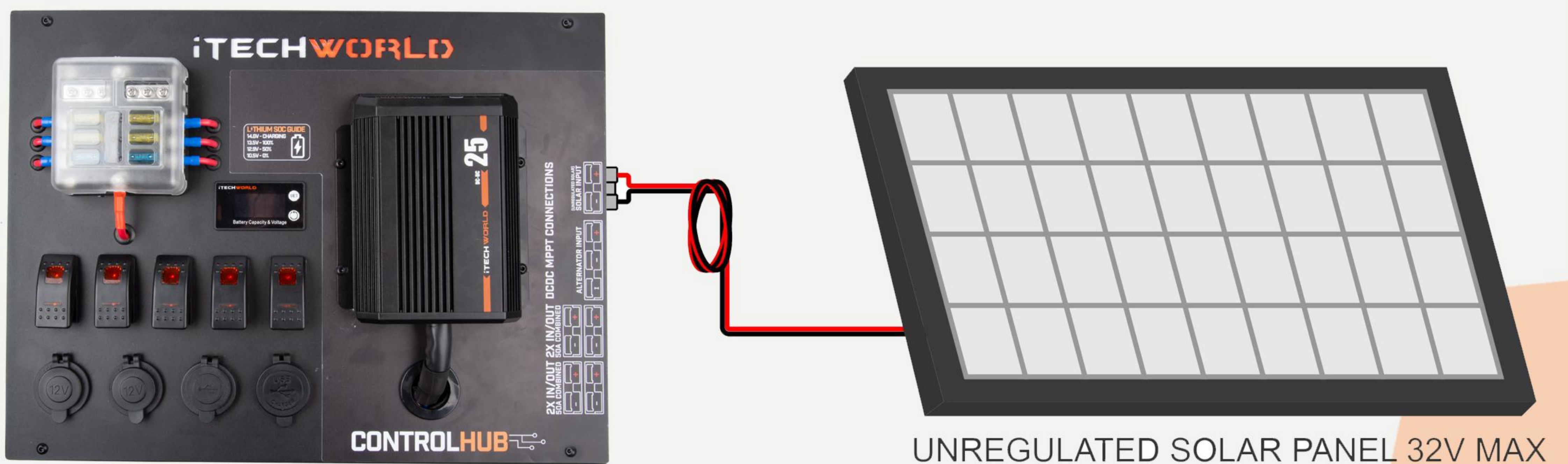



# NON DCDC CHARGER MODEL

The following information only applies to the itechworld Control Hubs fitted without a DCDC Charger.

## MOUNTING ITEMS ON THE CONTROL HUB

Other auto electrical accessories can be retrofitted to the control hub making use of the free space. The following precautions should be taken when mounting other equipment:

- Prior to drilling through the front face of the control hub, please be wary of hardware and wiring that may be located on the rear side of the face panel
- There are several blank holes covered by the sticker on the front face, you can use these holes for mounting equipment. You can locate these holes by looking at the rear side of the face panel, they have also been shown in the image below
- Mounting a DCDC charger to your control hub will not affect your warranty, unless it is determined to be the cause of the failure.



## DIY DCDC INSTALL

To install a different brand of DCDC Charger on the Control Hub , follow these instructions.

There are one pre-drilled holes for cabling on the face of the control hub , these are covered by the sticker. Simply locate one of these one holes and find a suitable location for mounting your DCDC on the front face of the unit. Cut the sticker with a sharp knife and drill suitable holes to mount your DCDC Charger.

If you wish to make use of the itechworld Plug and play wiring kits , blank 2 and 3 pin Anderson style plugs are available for purchase from the itechworld Store. These plugs can be mounted easily by cutting away or removing the foam insert on the inside of the control hub.

To connect your DCDC Charger output to your second battery via the control hub, simply attach the output positive to the DCDC charger positive post and the earth output to the DCDC charger ground post. Note: The fuse has been suitably sized for a 25A charger, should you be using a larger charger to may need to increase the fuse size.

Note: Mounting a DCDC charger to your control hub will not affect your warranty, unless it is determined to be the cause of the failure.

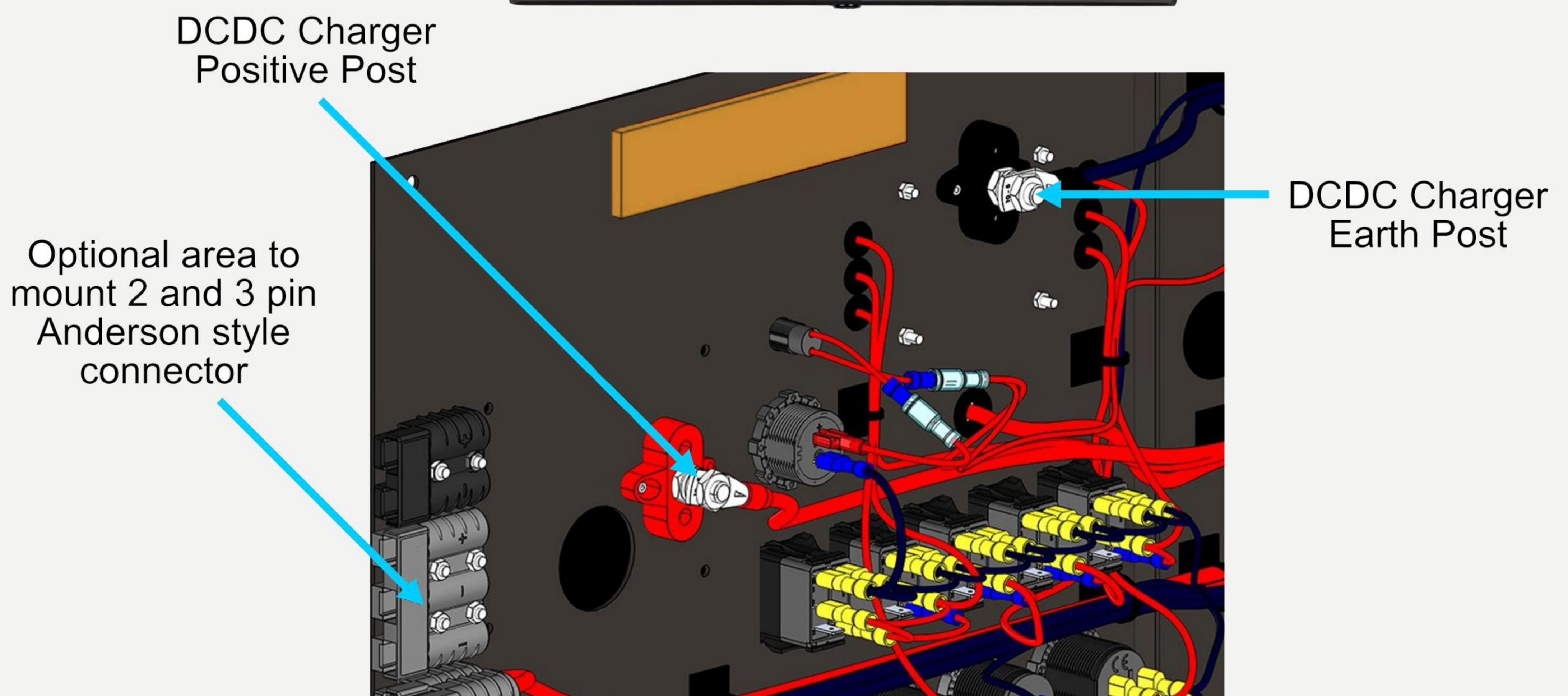



# WIRING DIAGRAM

