



iTECHWORLD

# SS RANGE

Super Slimline  
LITHIUM  
BATTERIES



User Guide







# USER GUIDE

## KEY FEATURES

The iTechworld SS range is the pinnacle of deep cycle lithium battery design. The SS range has preinstalled Battery Management System that accepts charge from almost every charging system making it perfect for use in 4wds, boats, caravans, motor-homes, RVs, and more.

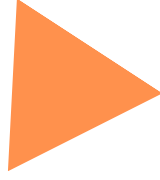
- Slimline metal design
  - Pre-installed Redback Operating System.
  - Pre-installed Battery Management System.
  - Pre-installed Cell balancing.
  - Heavy duty metal casing
  - High discharge current.
  - Maintenance-free
  - Lithium LiFePO4
  - Mounting brackets included
  - Over discharge protection (safe mode)
  - Australian design & development
  - Australian lithium
- 
- 
- 

# USER GUIDE

## GENERAL SPECIFICATIONS

- Nominal Voltage: 12.8v
- Short Circuit Protection: Yes
- Optimum Temperature Range: +5 to +60°C
- BMS Operational Temperature Range: -40 to 80°C
- Safety Protection Isolator: 80°C
- Recommended Charge Voltage: 14.4v
- BMS Charge Cut Off Voltage: 15v
- BMS Low Voltage Cut Off: 8.5-9v
- Life Cycles 100%: 4000 +
- Life Cycles 50%: 10000 +
- Life Cycles 30%: 16000 +
- iTECH200SS Terminal Type: M8
- iTECH100SS Terminal Type: 120A Anderson Plug
- Case Material: Metal

For more information on specifications please visit our website and select your iTechworld lithium battery.

Scan to visit our website







# USER GUIDE

## SAFETY

Please follow and understand these instructions before using the iTechworld battery; failure to do so can cause the battery to fail. It is strictly prohibited to disassemble the battery.

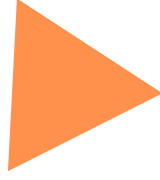

Inside the battery are electrolytes. These electrolytes can be skin and eye irritants. Don't touch the battery directly if you see any liquid on the battery. If there is electrolyte on your skin, please use soap and water to wash; if there is electrolyte on your eyes, please use lots of water to wash them and go to the hospital immediately.





# USER GUIDE

## DO'S AND DON'TS

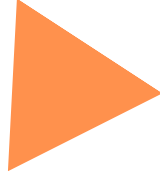
- Do not cross the polarity of the battery.
  - Never plug the battery directly into 240V mains power.
  - Do not open the casing.
  - Do not throw, squeeze, puncture, strike, contort, heat, burn, or disassemble battery.
  - Keep children and animals away from the battery.
  - Battery should be stored in a dry environment away from water.
  - Battery operates best if kept above 12.8V.
  - When charging do not exceed 15V input. A battery charger with cut out of 14.7V and under is required.
  - Do not use this battery in series or parallel with a lead acid battery, calcium battery or other brand battery.
  - Exposure to sunlight can increase discharge rate of battery.
  - If battery shows any shape change, colour change or any liquid seeping from battery stop using immediately and contact iTechworld.
  - If the battery terminal screws are corroded, be careful not to bend the terminals when tightening or loosening.
  - Do no short-circuit the battery by directly connecting the positive and negative terminals together or with metal conductive objects.
  - Do not transport the battery together with metal objects that are conductive.
  - Do not leave the battery in safe mode for any longer than 7 days.
- 
- 
- 



# USER GUIDE

## OPTIMISING YOUR CHARGING

The iTechworld SS range of batteries has a sophisticated Battery Management System, Cell Balancing and the Redback Operating System pre-installed. This hardware allows the batteries to be charged from almost all non-lithium charging profiles. We suggest following our guidelines below to optimise the system for charging systems where the parameters can be changed. If your charger has a dedicated lithium charge profile, use that profile.

BULK: 14.4v

ABS: 14.4v

FLOAT: 13.5V

Recommended charging current:

iTECH100SS: 1a - 50a

iTECH200SS: 1a - 100a



# USER GUIDE

## DISCHARGE CURVE

Please note that a lithium battery's discharge curve will differ from your previous lead acid batteries. Please study the discharge curve below to better understand how the lithium battery will perform.

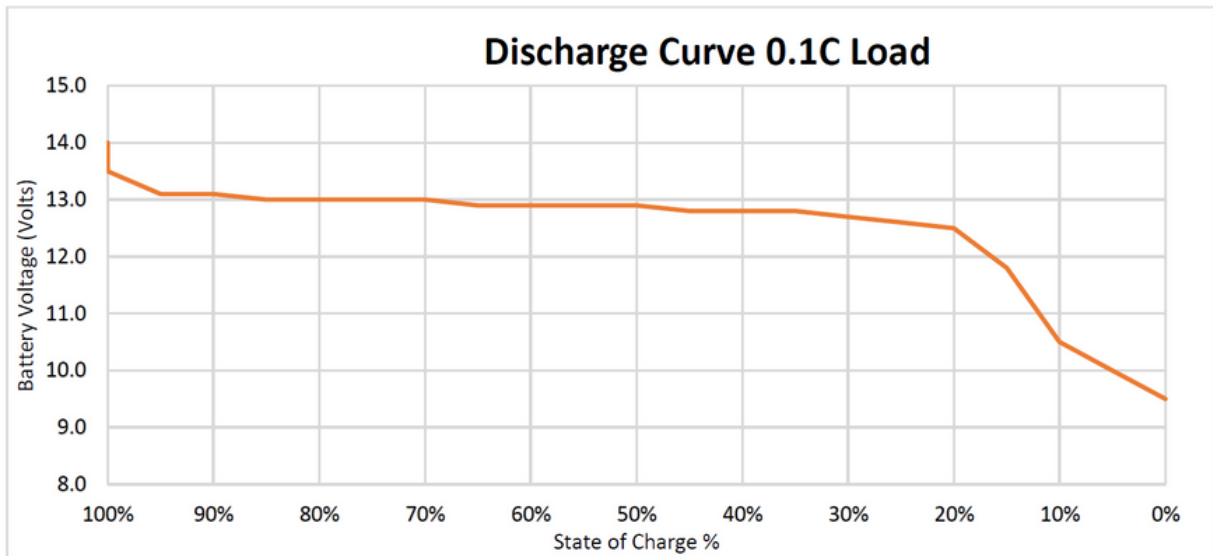

State Of Charge	Voltage under load 0.1C
100%	14.0V
100%	13.8V
100%	13.5V
95%	13.1V
90%	13.1V
85%	13.0V
80%	13.0V
75%	13.0V
70%	13.0V
65%	12.9V
60%	12.9V
55%	12.9V
50%	12.9V
45%	12.8V
40%	12.8V
35%	12.8V
30%	12.7V
25%	12.6V
20%	12.5V
15%	11.8V
10%	10.5V
0%	9.5V

# USER GUIDE

## PRODUCT DIMENSIONS

### ITECH100SS

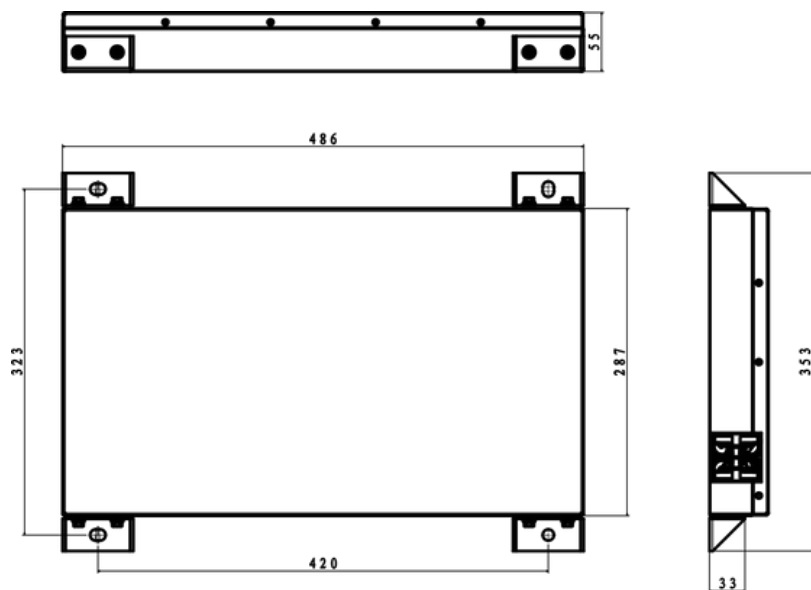

### ITECH200SS

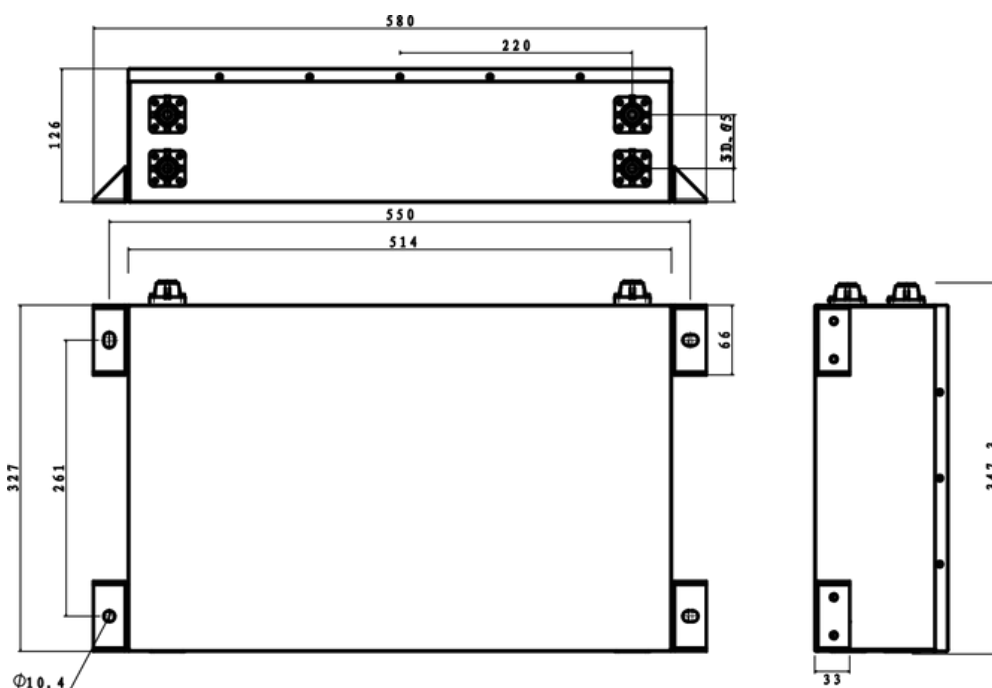



# USER GUIDE

## PARALLEL CONNECTION

### ITECH100SS

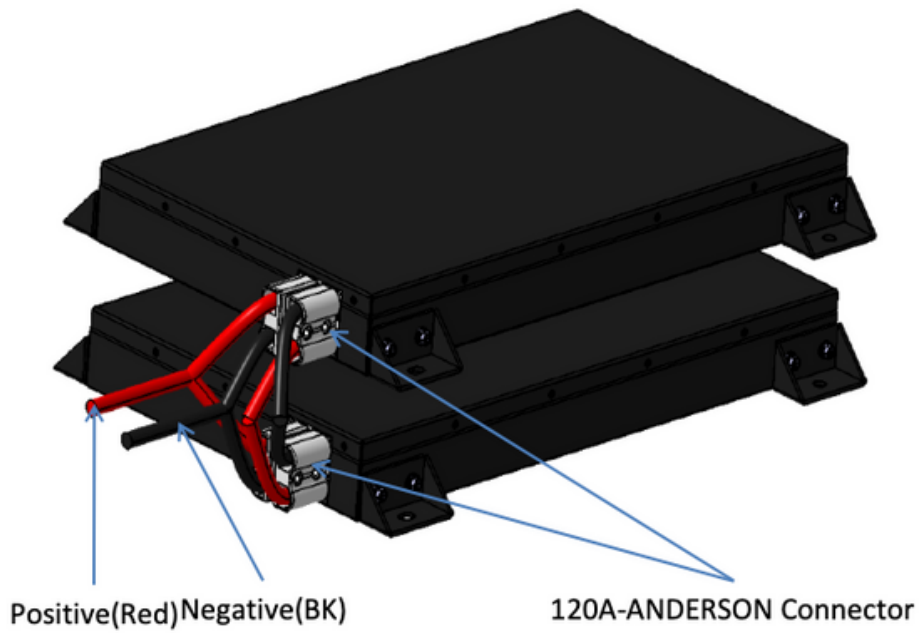

### ITECH200SS

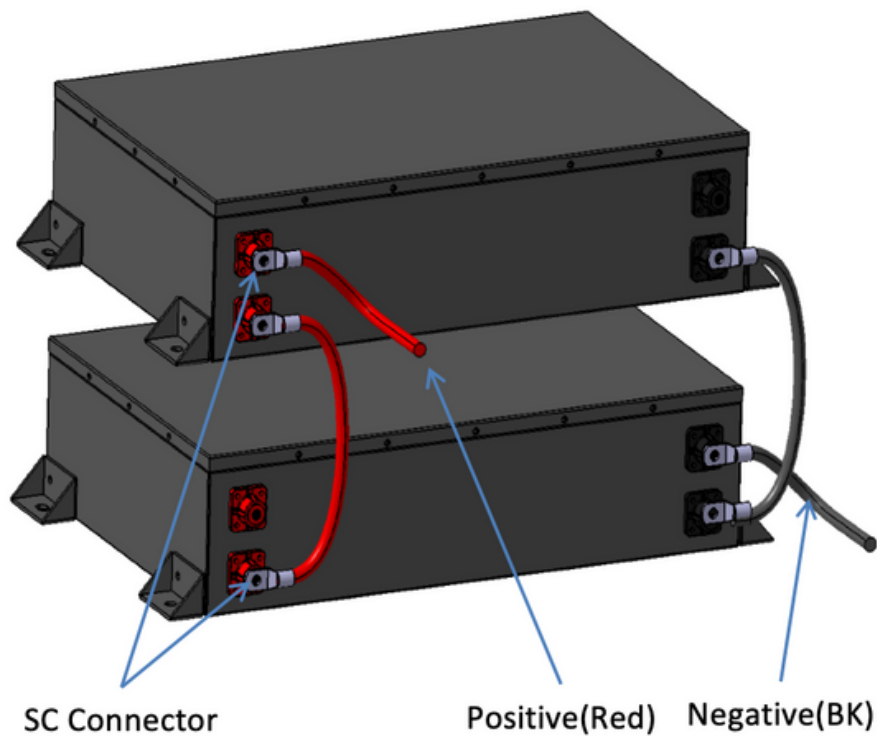

# USER GUIDE

## SERIES CONNECTION

### ITECH100SS

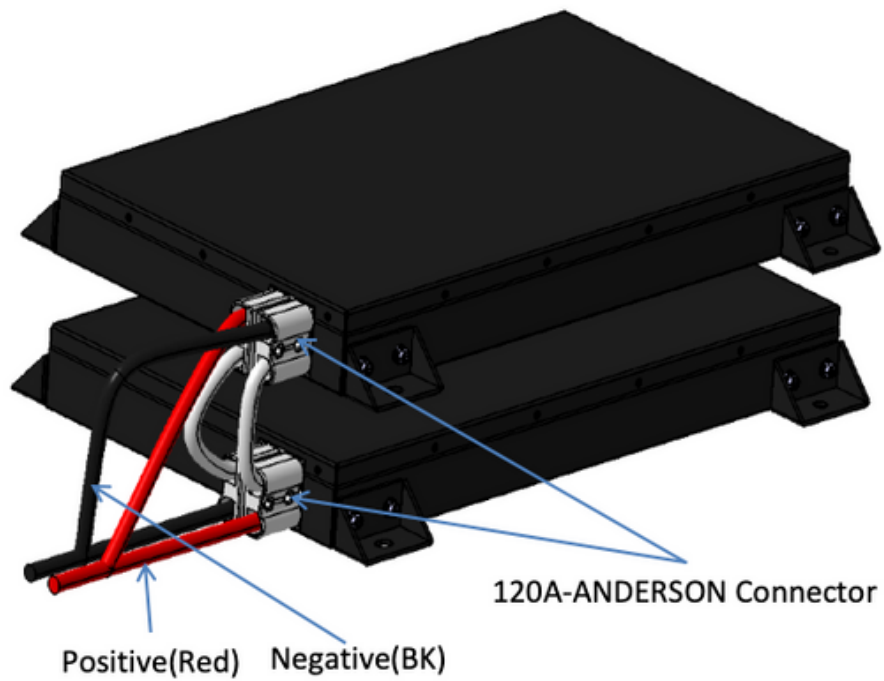

### ITECH200SS

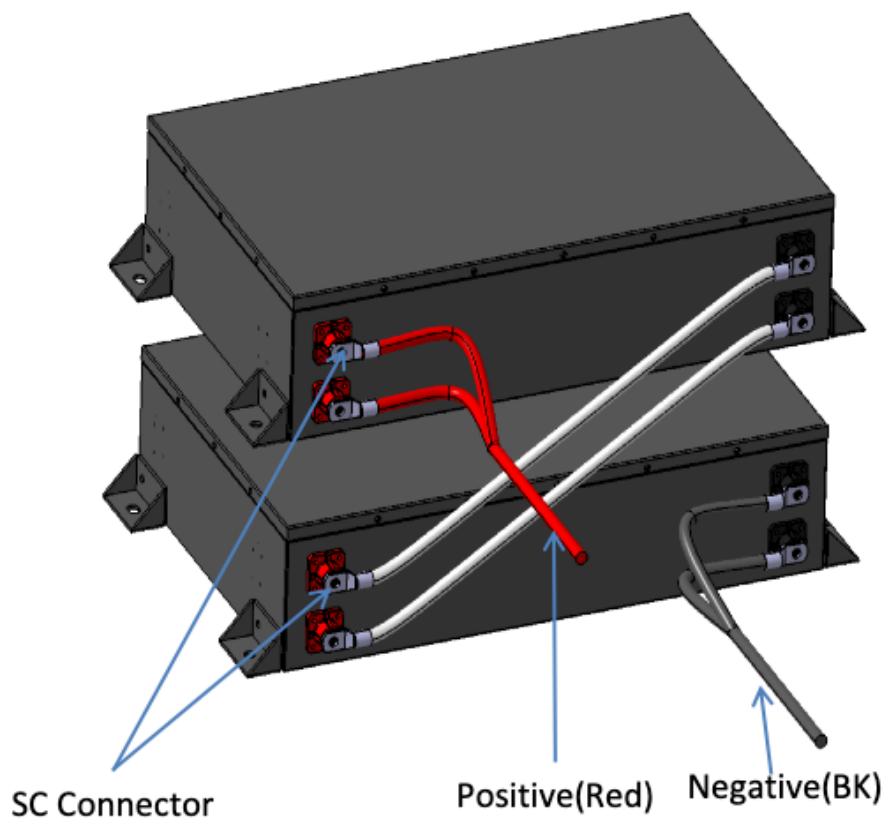





# USER GUIDE

## SAFE MODE

Inside each iTechworld battery is a Battery Management System that has several different safety features that you will not find in lead acid, calcium or even other lithium batteries. To ensure iTechworld batteries are the safest batteries available in the Australian market, we install over-current protection, over-voltage protection, high and low-temperature protection, cross polarity protection, and over-discharge protection. If one of the safety features is triggered, the iTechworld lithium battery will enter safe mode, the battery will then become unusable until it is brought out of safe mode.

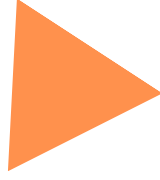
In all instances, other than discharging your battery below 10v, the battery can bring itself back out of safe mode. For example, if the battery's internal temperature reaches 80 degrees, the battery enters safe mode, the battery's internal temperature cools below 80 degrees, and the battery will bring itself out of safe mode.



# USER GUIDE

## SAFE MODE

The most common reason for an iTechworld battery to go into safe mode is from draining the battery to a voltage of 10v or less. We recommend the iTECHBC20 and iTECHBC40 AC chargers as they automatically bring iTechworld batteries out of safe mode. If you do not have an iTECHBC20 or iTECHBC40, follow the methods below to bring your battery out of safe mode.

If you have a charged battery (E.G., car battery), jumper cables and a battery charger, follow the below steps to bring your iTechworld lithium battery out of safe mode.

- Disconnect all loads/inputs from the iTechworld battery.
- Connect the iTechworld battery in parallel to a different battery (battery number 2)
- Cross-reference the voltage on each battery in parallel – they should both now read a similar voltage.
- Connect an A.C 240v charger or a DCDC charger to the iTechworld battery and allow it to begin charging. We recommend a three-stage charger 20 – 40 amp charger for all our batteries over 60ah.
- For batteries under 60ah, the charger's current output rating should be approx. half of the battery's capacity, examples:

50ah battery = 25amp charger

24ah battery = 12amp charger

7ah battery = 3.5amp charger

- When the charger begins to charge the iTechworld battery, disconnect battery number 2.
- The charger will continue to charge the iTechworld battery, bringing it out of safe mode.
- Allow the charger to charge the battery fully.
- Do not reintroduce a load until the battery is fully charged.



# USER GUIDE

## SAFE MODE



If you have a portable Jump Starter, follow the below steps to bring your iTechworld lithium battery out of safe mode.

- Disconnect all loads/inputs from the iTechworld battery.
- Connect the Jump Starter cables to the battery (Positive to Positive, Negative to Negative)
- Connect an A.C 240v charger or a DCDC charger to the iTechworld battery and allow it to begin charging. We recommend a three-stage charger 20 - 40 amp charger for all our batteries over 60ah.
- For batteries under 60ah the charger's current output rating should be approx. half of the battery's capacity, examples:

50ah battery = 25amp charger

24ah battery = 12amp charger

7ah battery = 3.5amp charger

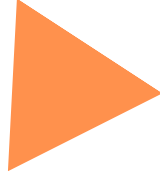

- Activate the jump starter to supply power to the iTechworld battery. The charger will now detect the battery and begin to charge.
  - When the charger begins to charge the iTechworld battery, disconnect the Jump Starter from the battery.
  - The charger will continue to charge the iTechworld battery, bringing it out of safe mode.
  - Allow the charger to charge the battery fully.
  - Do not reintroduce a load until the battery is fully charged.
- 
- 
- 



# USER GUIDE

## SAFE MODE

If you have a portable solar panel, follow the steps below to bring your iTechworld lithium battery out of safe mode.

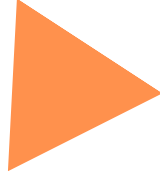
- Disconnect all loads/inputs from the iTechworld battery.
  - Disconnect the solar controller/regulator from the solar panel.
  - Connect the unregulated solar panel to the iTechworld battery.
  - Leave for 5 minutes.
  - Disconnect the unregulated solar panel from the iTechworld battery.
  - The iTechworld battery will have voltage present, allowing for use with a charger or regulated solar panel.
  - Charge the battery to 100%
  - Do not reintroduce a load until the battery is fully charged.
- 
- 
- 

# USER GUIDE

## ITECHWORLD LITHIUM BATTERY BYPASS SWITCH

The bypass switch, allows the reset mechanism to be permanently wired to your iTechworld battery and allows for remote BMS resetting, both batteries must be on the same negative ground:

1. Install the bypass switch connecting only the positive terminals of the iTechworld battery and your main starting battery, or any other battery. Both batteries must share the same negative ground, the arrow indicated on the switch must point to the iTechworld battery.
2. Once the cable is installed you can simply press and hold the button for a few seconds to reset the BMS.



# USER GUIDE

## ITECHWORLD LITHIUM BATTERY BYPASS SWITCH

If you have our DCDC charger, you can wire it according to the diagram below.

1. Install the bypass switch connecting only the positive cable of the iTechworld battery and your main starting battery or any other battery.
2. Both batteries must share the same negative ground, iTechworld DCDC chargers have an internal common ground. Once the cable is installed, you can simply press and hold the button for a few seconds to reset the BMS.

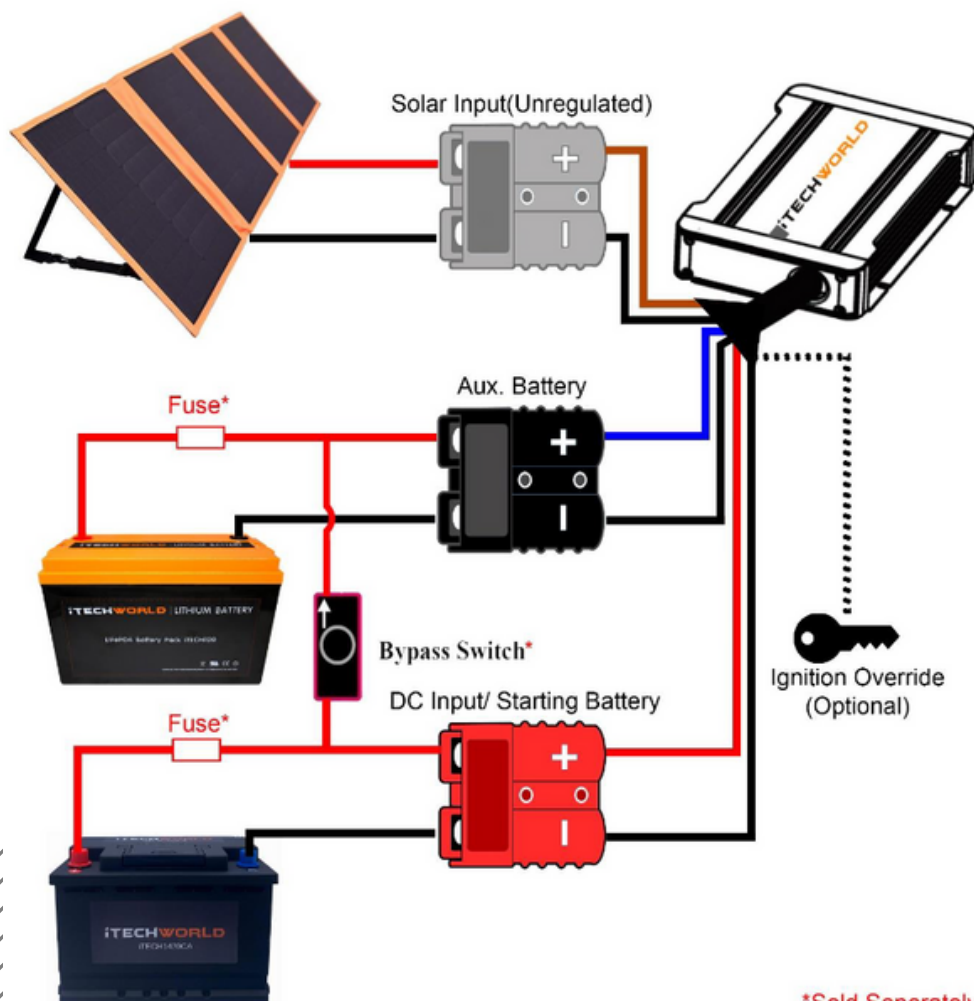

\*Sold Separately







# USER GUIDE

## STORAGE

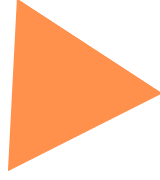
Long-time storage in a hot or wet environment will damage the battery. The battery should be stored in dry and ventilated environment. The ideal storage temperature is below 25°C. If stored this way, it will extend the battery life. If the storage temperature surpasses 40°C for an extended period (more than 30 days), battery life may be shortened; if the storage temperature surpasses 55°C, the battery can be damaged. When the battery is stored for more than 50 days, the preferred storage voltage is 13.2V. Checking the voltage and charging when required should be done every 60-90 days.







# USER GUIDE

## TRANSPORTING

The iTechworld lithium battery should always be carefully handled. Don't throw the battery and avoid squeezing it i.e do not pack heavy objects on top of the battery.

The battery is robust and designed to handle off-road bumps.

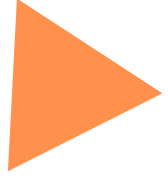
Ensure the battery is in a secure spot where it cannot be punctured. Do not store battery with flammable, explosive goods or sharp metals. Upon delivery of battery from iTechworld please inspect for openings in the casing or other damage that could have been caused in transit. Contact iTechworld immediately if the battery does not seem right after taking delivery.





# USER GUIDE

## WARRANTY

iTechworld warrants its SS lithium battery range to be free of defects in material and workmanship for the following Applicable Warranty Period:



- *3 years for automotive applications in cycling and non-cycling applications*

### **Three Year Limited Warranty**

Our goods come with guarantees that cannot be excluded under the Australian Consumer Law. You are entitled to a replacement or refund for a major failure. You are also entitled to have the goods repaired or replaced if the goods fail to be of acceptable quality and the failure does not amount to a major failure.

The limited warranty program is the only one that applies to this unit, and it sets forth all the responsibilities of iTechworld. There is no other warranty, other than those described herein. Any implied warranty of merchantability of fitness for a particular purpose on this unit is limited in duration to the duration of this warranty.

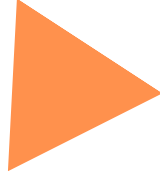
iTechworld does not warrant the battery for use in any residential system sold with the intent or purpose of a “Tariff Adjustment Program” of any type.



The warranty does not cover a battery reaching its normal end of life which may occur prior to the warranty period stated above. Depending on the application a battery can reach its normal end of life before the end of the warranty period.



# USER GUIDE



## WARRANTY

A battery can deliver only a fixed number of usable cycles / amp-hours over its lifetime and is considered to have reached its normal end of life if the application uses up all of these cycles / amp-hours, regardless of the time the battery has been in service. Therefore, iTechworld reserves the right to deny a warranty claim if it determines the battery to be at its normal end of life, even if the claim is lodged within the applicable warranty period.

The Applicable Warranty Period begins from the date of purchase with original receipt.

Batteries determined to meet the conditions of this warranty will be replaced free of charge if, at the sole discretion of iTechworld, adjustment is necessary due to defect in material or workmanship. Batteries for warranty replacement consideration are to be returned to iTechworld, PO BOX 223 BURSWOOD WA 6100.

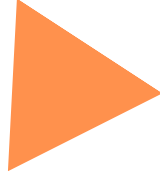
Batteries replaced under the warranty provisions will be shipped with a replacement warranty sticker and carry only the remainder of the original Applicable Warranty Period.







# USER GUIDE

## WARRANTY

The SS lithium battery range is not designed or warranted in the following areas:

- The Battery is NOT to be used in any Aviation aircraft application.
- The Battery is NOT to be used in any lifesaving applications.
- The Battery is NOT to be exported.
- Any residential system sold with the intent or purpose of a “Tariff Adjustment Program”.

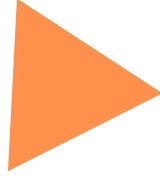
**PLEASE NOTE:** The battery has a self-discharge rate (low). It is the responsibility of the end user to maintain the battery in a charged state. The battery should not be left for more than 60-90 days without checking its charge state. iTechworld recommends that a battery left in a “storage state” should be checked and charged every 60-90 days to maintain the maximum life expectancy of the battery. Failure to follow these requirements will see an early failure of the battery, which is not covered under warranty.







# USER GUIDE

## WARRANTY

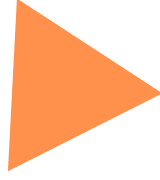

**General Provisions:** iTechworld has no obligation under the limited warranty herein in the event the battery is damaged or destroyed as a result of one or more of the following:

- Wilful abuse, misuse, physical damage, neglect or if the decorative cover has been removed.
  - Natural forces such as wind, lightning, hail; damage due to fire, collision, explosion, vandalism, theft, penetration or opening of the battery case in any manner
  - The iTECH100SS can be mounted in any orientation (due to the Anderson Plug output). However, the iTECH200SS can be mounted any orientation other than upside down (terminals down).
  - Overcharging, undercharging, charging or installing in reverse polarity, improper maintenance, allowing the battery to be deeply discharged via a parasitic load or mishandling of the battery, such as but not limited to using the terminals for lifting or carrying the battery.
  - Charging sources must have a charge voltage between 13.3V and 15V. Failure to do so will cause early failure of the battery. The use of such chargers with the battery will also void the battery's warranty.
- 
- 
- 



# USER GUIDE

## WARRANTY

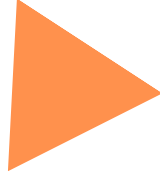
- Failure to install the battery correctly will void the warranty.
  - Repair or attempted repair of the battery by anyone other than an authorized iTechworld representative shall void this warranty.
  - Normal or accelerated deterioration in the electrical qualities due to operating or application conditions.
  - If the battery is used for an application that requires higher cranking power or a greater reserve rating than the battery is designed to deliver, or the battery capacity is less than the battery capacity specified by the manufacturer, or the battery is otherwise used in applications for which it was not designed.
  - Prolonged storage of the battery with either no charge or a parasitic consumption load applied must be offset with a maintenance-float charger of no more than 13.5V or periodic charging or disconnecting the battery to prevent irreversible damage to the battery.
  - A battery with an open circuit voltage (OCV) of equal to or less than 10.0V will be deemed as over discharged and void warranty due to misuse and/or neglect.
  - **WARNING** – Do NOT use any type of oil, organic solvent, alcohol, detergent, strong acids, strong alkalis, petroleum-based solvent or ammonia solution to clean the battery covers and end plates. These materials may cause permanent damage to the battery covers and end plates and will void the warranty.
- 
- 
- 



# USER GUIDE



## WARRANTY

### **Return and/or Repair Policy**

If you are experiencing any problems with your battery, please visit our help centre

[www.itechworld.com.au/helpcentre](http://www.itechworld.com.au/helpcentre)

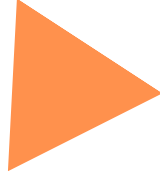
We provide FAQ, Troubleshooting and wiring diagrams. You can also contact our customer service team via the help centre.







# USER GUIDE

## WARRANTY

### **Limitations**

This warranty does not cover damage or defects resulting from normal wear and tear (including chips, scratches, abrasions, discolouration or fading due to usage or exposure to sunlight and water), accidents, damage during shipping to our service facility, alterations, unauthorized use or repair, neglect, misuse, abuse, failure to follow instructions for care and maintenance, acts of god, fire, flood and force majeure.

