

iTECHWORLD

THE POWER EXPERT

iTECHBC40

40A Intelligent Lithium Battery Charger

USER GUIDE



SAFETY PRECAUTIONS

For safe operation and ideal performance, the iTechBC40 40A Intelligent Lithium Battery Charger must be installed and operated correctly.

Please carefully read, understand, and follow all instructions and guidelines in this User Guide. Failure to follow these instructions may result in damage to the unit, property, death, or serious injury.

Disclaimer:

While iTechworld has taken every precaution to ensure the accuracy of the contents of this user guide, iTechworld assumes no responsibility for any errors or omissions.

FURTHERMORE, ALL SPECIFICATIONS AND FUNCTIONALITY MAY CHANGE AT ANY TIME WITHOUT NOTICE.

1. **WARNING:** People with physical disabilities, visual, sensory, or mental impairments (including children) should not use this device. Children should be supervised to ensure they do not play with battery chargers.
2. **DANGER:** Do not disassemble or modify the charger (there are no user serviceable parts inside), doing so will void warranty, and may result in a risk of electrical shock, fire, death, or serious injury.
3. **DANGER EXPLOSION HAZARD:** Do not use the charger in an environment where flammable fumes or gases are present (such as gas bottles, petrol engines or lead acid battery compartments)
4. **DANGER:** This charger is only suitable for charging 12V Lithium Iron Phosphate batteries (LiFePO₄) containing an inbuilt battery management system (BMS) that features under and over voltage protection with cell balancing. The charger should not be used to charge any other types of batteries, or for charging damaged or non-rechargeable batteries, doing so may result in in a risk of fire, death, or serious injury.
5. **DANGER:** Never charge a frozen battery. If a battery is frozen, move it into a warmer area and let the battery thaw/warm up before charging it.
6. **DANGER:** Do not expose this charger to water, rain, snow, or dusty environments.
7. **WARNING:** Ensure the charge voltage does not exceed the battery's recommended maximum charging voltage. If you are unsure of the maximum charging voltage of your battery, please consult your battery's manufacturer.
8. **WARNING:** Ensure that the continuous output current of the charger does not exceed the battery's recommended maximum charging current. If you are unsure of the maximum charging current of your battery, please consult your battery's manufacturer.
9. **DANGER:** Never smoke or allow a spark or flame in vicinity of battery or engine. This may cause the battery to explode.
10. **DANGER:** Never touch the battery clamps together when the charger is switched on.
11. **DANGER:** Do not connect the battery charger output in reverse polarity (e.g., RED clamp to B- and Black clamp to B+).
12. **LIMITATIONS OF USE:** Do not use in connection with life support systems or other medical equipment or devices.

Introduction

The iTECHBC40 battery charger is a smart multi-stage lithium battery charger. This charger uses the latest switch-mode battery charging technology, to ensure fast and efficient charging of your LiFePO₄ battery. The multi-stage charging algorithm delivers a fast, efficient, and consistent charge with no voltage drop. The iTECHBC40 will prolong the longevity of the battery cells and prevents premature battery failure.

The iTECHBC40 battery charger also features an innovative boost-charge feature; this helps activate a battery with low voltage. The boost-charge feature will “wake up” a weak or flat battery to a suitable recharging voltage.

Specifications

	Parameters
Input Voltage	200-265VAC @ 50Hz
Bulk/Absorption Charging	14.6V
Restart voltage	13.2±0.2V
DC output current	Up to 40A
Efficiency	Up to 88%
Operating Temperature (Ambient)	0-60°C
Ventilation	Active temperature-controlled fan cooling

Front Panel

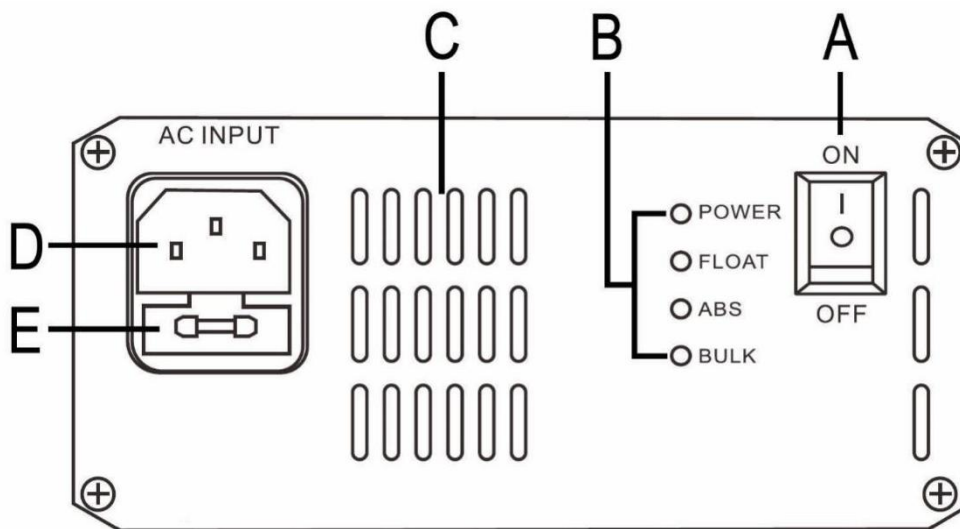

A	Main Switch
B	Power and charge stage indicator LED
C	Ventilation Slots
D	AC Power Input Socket
E	240V 5A AC Fuse

Rear Panel

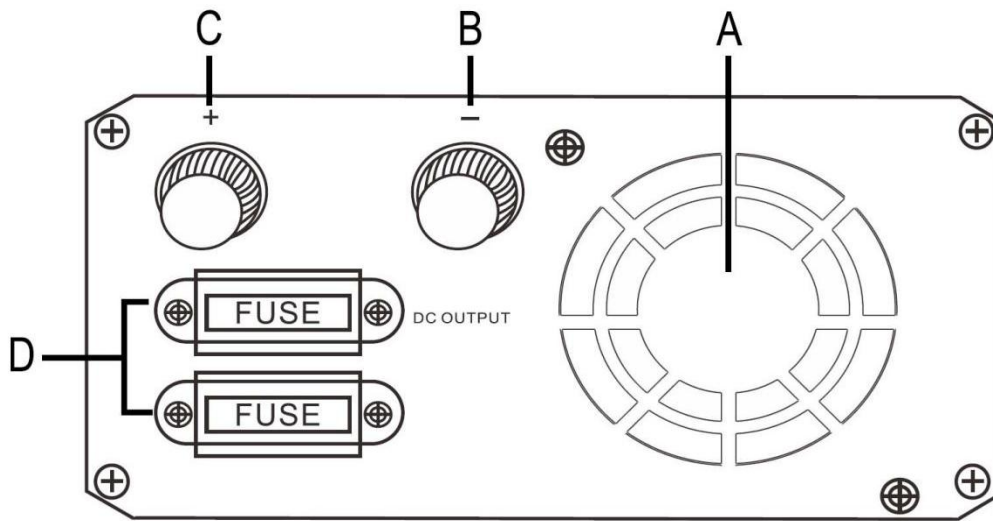

A	Cooling Fan
B	DC Output Negative Terminal (Black)
C	DC Output Positive Terminal (Red)
D	DC Output Protection Fuses(45Amps)

Installation

Mounting the charger

If permanently mounting the battery charger, the location where it is mounted must be:

- **Dry:** Do not allow any liquids to drip or splash onto the unit
- **Cool:** Do not install in direct sunlight or close to any heat sources, the ideal ambient air temperature is between 15°C to 25°C.
- **Ventilated:** Allow at least 60mm of clearance around the charger to allow for adequate air flow, and make sure that the cooling fan and ventilation slots are not obstructed.
- **Clean:** Do not install the charger in a dusty environment, as the charger contains a cooling fan, any dust present will be sucked into the charger which may damage or shorten the lifespan of the charger.
- **Close to batteries:** Avoid excessive cable lengths as this will cause voltage drop and may cause problems with charging your batteries.

Note: If the charger is to be mounted on a hard surface (such as metal or wood board) please ensure some antivibration mounts are used between the charger and the mounting surface.

Product Function

Unit Operation

1. Make sure that the Main Switch on the front panel is in the **OFF** position, and the 240V AC supply is disconnected.
2. Connect the DC output to the battery requiring charge, pay close attention to the polarity when connecting the charger to the battery (**RED** to Battery +, **BLACK** to Battery -), as reverse polarity may cause damage to the charger.
3. Connect the AC power cable to the AC input socket and turn on the 240V AC supply.
4. Turn the Main Switch on the front panel to the **ON** position, the battery charger will now begin to charge the connected battery.
5. When done charging the battery, turn the Main Switch on the front panel to the **OFF** position, unplug the AC power cable.
6. Remove the charging cables from the battery.

Multi-Stage Charging Algorithm

The iTECHBC40 40A Intelligent Lithium Battery Charger utilises a 3-stage charging algorithm to deliver a fast, efficient, and consistent charge, prolonging the life of your battery. The stages can be visualised in the graph below, with voltage(V) and current(I) over time(T).

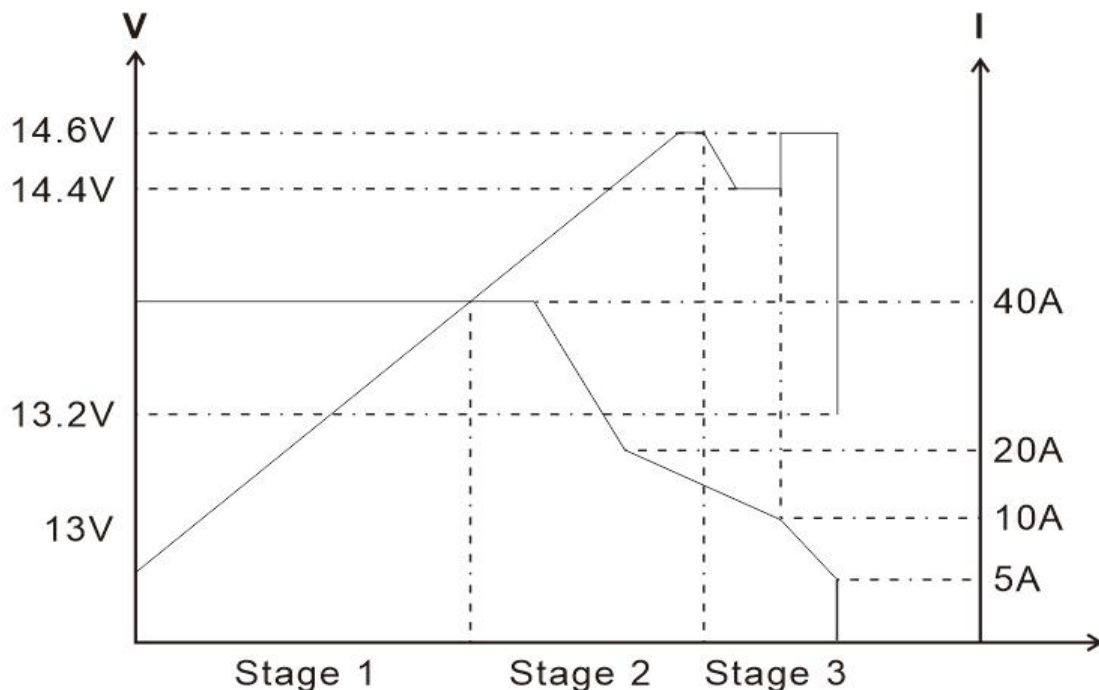

Lithium battery voltage lower than $13.2V \pm 0.2V$, charger will restart.

Charging Stages:

Stage 1 Bulk or Boost Charge (Constant Current): This stage supplies the maximum rated current of the charger at a constant rate until the battery reaches the final charging voltage (absorption voltage) this ensures, that the battery is charged to approximately 80% capacity in the shortest amount of time.

Stage 2 Absorption Charge (Constant Voltage): In this stage, the charging voltage is held constant for the remaining 20% capacity of the battery, and the current is gradually decreased as the battery approaches full charge.

Stage 3 Float Charge: Once the battery has reached full charge, the charger voltage is then lowered and held constant. This prevents over charging the battery and prolongs the life. This stage is often referred to as a maintenance mode, rather than charging a battery, it keeps an already charged battery from discharging while providing power to any additional loads connected to the battery, such as fridges and lights.

Charge Stage Indicators:

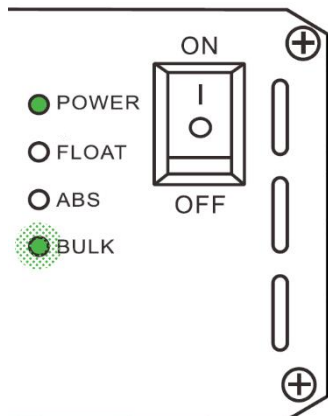

When the charger is in the first stage of charge, the Bulk LED will be flashing

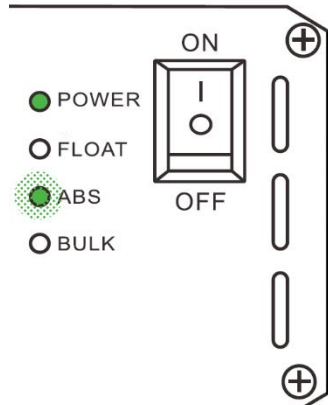

When the charger is in the second stage of charge, the Abs LED will be flashing

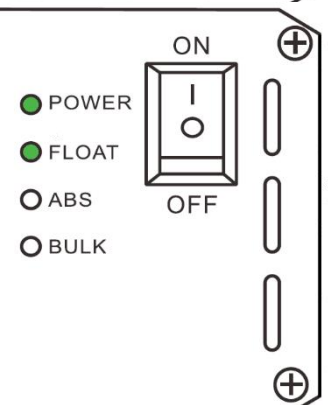

When the charger is in the maintenance stage, the Float LED will be lit solid.

When a load is applied, it is normal for the battery voltage to decrease until approximately 13.0 Volts, where the charger will start charging again.

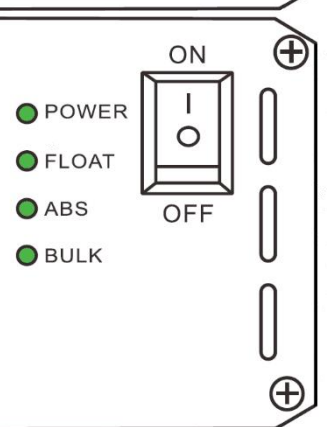

If all lights are illuminated solid, turn the charger off and inspect all connections between the charger and battery to ensure that they are tight.

Then disconnect the battery and check the DC output fuses.

Troubleshooting

<u>Symptom</u>	<u>Possible Cause</u>	<u>Solutions</u>
Battery is not receiving charge	No AC input	Check AC power source and the fuse.
	Charger has overheated	Allow the charger to cool down, make sure all fan inlets and ventilation slots are not obstructed. Relocate the charger to a cooler location.
	Bad connection between charger and battery	Check the connection between the charger and battery.
	Output Short circuit	
Charger is not reaching the float stage	The cable connecting the battery to the charger may be too thin, or too long.	Shorten the cable length, use larger cables, or use the supplied cables.
	Battery has a fault.	Check the charger on another battery.
	A load is constantly drawing from the battery while the charger is on.	Lower or disconnect the load connected to the battery.
All lights are illuminated	The connected lithium battery has gone into protection mode (safe mode)	Check for any short circuits, or if the battery has disconnected due to overvoltage, drain the battery.
	Loose or bad connection between the charger and battery.	Make sure all connections between the charger and battery are tight. Make sure there are no breaks in the cables.

Maintenance and Warranty

Maintenance:

Make sure that the battery charger is turned off and disconnected from both the battery and 240V AC input while performing any maintenance.

To keep your battery charger operating properly, there is very little maintenance required.

You should clean the exterior periodically with a dry cloth to prevent the build-up of dust and dirt.

Also check and tighten the fasteners on the DC output terminals.

Warranty:

iTechworld guarantees this product against defects in materials and workmanship for a period of 12 months from the date of purchase. This warranty will be considered void if the unit has been misused, altered, or accidentally damaged. iTechworld will not be liable for any amount of damage in excess of the retail purchase price of the unit under any circumstances. Incidental and consequential damages are specifically excluded from coverage under this warranty.

This battery charger is not intended for commercial use. This warranty does not apply to damage to units from misuse or incorrect installation/connection. Misuse includes wiring or connecting to improper polarity sources.

Return/Repair Policy:

In the unlikely event that technical problem arises, please contact iTechworld customer service on **1300 483 249** or email **service@itechworld.com.au** before returning the charger back to the store.

If such a unit is returned within the warranty period, iTechworld will repair the unit or, at its discretion, replace it, free of charge. If the unit is repaired, new or reconditioned replacement parts may be used, at the manufacturer's discretion. A unit may be replaced with a new or reconditioned unit of the same or comparable design. The repaired or replaced unit will then be warranted under these terms for the remainder of the warranty period. The customer is responsible for the shipping charges on all returned items back to iTechworld.

Limitations:

This warranty does not cover accessories, such as adapters and batteries, defects or damage resulting from normal wear and tear (including but not limited to chips, scratches, abrasions, discoloration or fading due to usage or exposure to sun or environmental elements), accidents, damage during shipping to iTechworld's service facility, alterations unauthorized use or repair, neglect, misuse, abuse, failure to follow instructions for care and maintenance, fire, and flood.

Contact

iTechworld

281 Great Eastern Hwy

Burswood WA 6100

Phone: 1300 483 249

Website: www.itechworld.com.au