



iTECHWORLD

ITECH2000A

MULTIFUNCTIONAL JUMP
STARTER



User Guide





USER GUIDE

INTRODUCTION

The iTECH2000A is a multi-functional jump starter device. The primary function of the iTECH2000A is to jump start your vehicle if it has a flat battery, any petrol vehicle and diesel vehicles up to 8L. In order to get the full benefit of the iTECH2000A it is important to read and understand the user guide. In the unfortunate event that you do have a flat battery, correct user operation of the iTECH2000A will ensure a quick fix to the flat battery and will get you out of trouble.

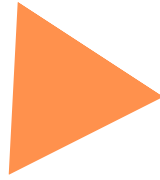
The iTECH2000A's secondary function is as a battery storage device. The iTECH2000A can be used to charge mobile devices, tablets, cameras, and to run 12v appliances such as a 12v fridge.

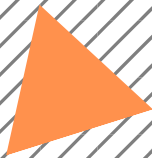

USER GUIDE

KNOW YOUR GEAR

GETTING TO KNOW YOUR ITECH2000A

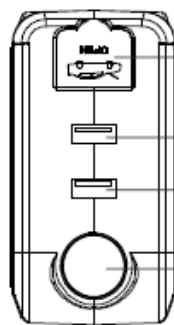

12V start port

USB1 9V port

USB2 5V port

LED light

Wireless Charging Area

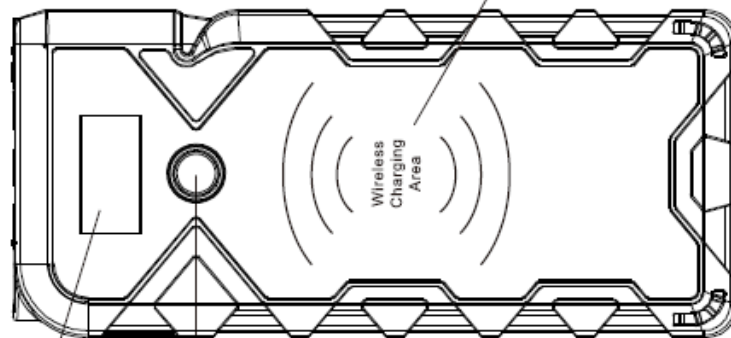

LCD screen

Large red on/off button

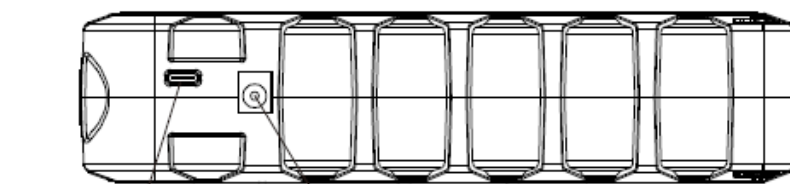

Charging Port

12V/8A Output port

USER GUIDE

OPERATING INSTRUCTIONS CHARGING YOUR ITECH2000A

You can charge your ITECH2000A one of two ways:

1. Using the supplied 240volt mains charger.

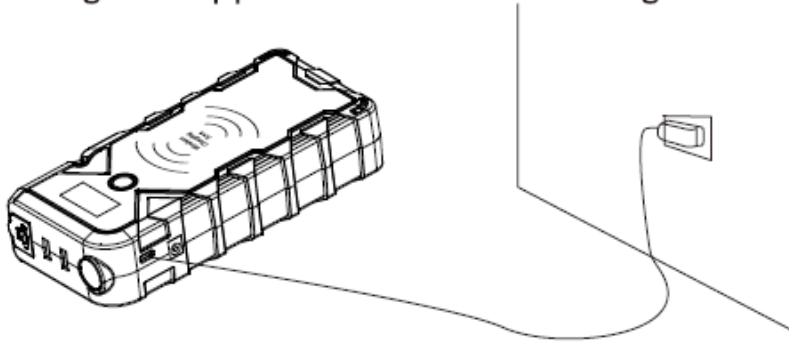

OR

2. 12V car charger into the jack of cigar lighter.

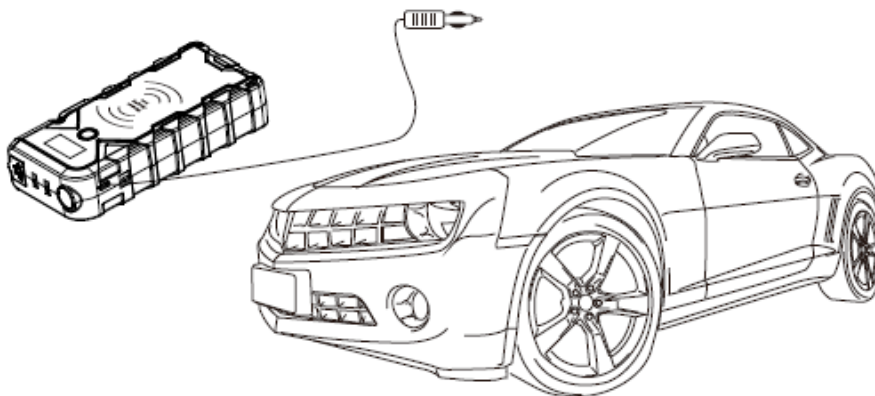

※ Charging takes 4-5 hours using either charging options.

USER GUIDE

STARTING YOUR VEHICLE

For the best results, please ensure your iTECH2000A is no less than 80% charged. If it is below 80% you may not be able to start 3L + diesel vehicles.

- Connect the intelligent jumper leads into your iTECH2000A.
- Connect the + (red clamp) to the + on your vehicle battery.
- Connect the - (black clamp) to the - on your vehicle battery.

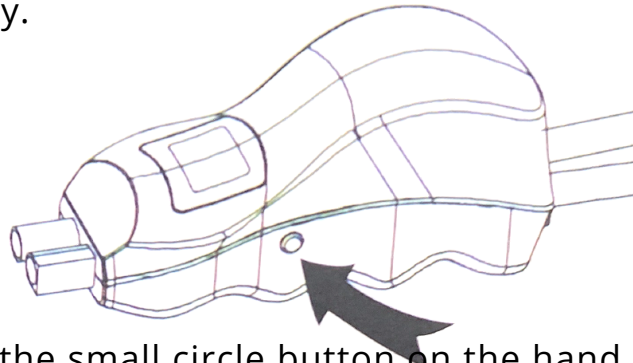

- Press the small circle button on the hand piece of the intelligent jumper leads. This will initiate a 60 second countdown on the hand piece screen of the intelligent jumper leads.
- Turn your key to start the vehicle before the countdown reaches zero.
- Once the vehicle has started disconnect the intelligent jumper leads from the battery first and the iTECH2000A second.
- If your vehicle does not start, repeat this process.



USER GUIDE

INTELLIGENT JUMPER LEADS: ERROR MESSAGES

ERR1: Intelligent Jumper Leads are not making a good enough connection to the vehicle's battery terminals.



ERR2: The Intelligent Jumper Leads are short circuited.

ERR3: Over voltage - The voltage of the jump starter of the voltage of the vehicle battery.

ERR4: The Jump Starter does not have enough voltage to start the vehicle - recharge your iTech2000A.

ERR5: The temperature of the Jump Starter is too high.

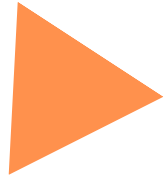
ERR7: The starting current of the vehicle exceeds 2000CCA.

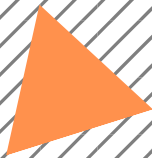

USER GUIDE

TURNING YOUR ITECH2000A ON/OFF

The iTECH2000A does not require to be turned on to be used as a jump starter, only when used as a battery bank. Please note that when your iTECH2000A is switched on it will have a self discharge rate due to the back lit screen and the wireless charging zone. Always turn your iTECH2000A off before storing.

To turn your iTECH2000A on, press the large red on/off button. The screen will illuminate in blue.

To turn your iTECH2000A off, press and hold the large red on/off button for 5-7 seconds or until the screen turns off.

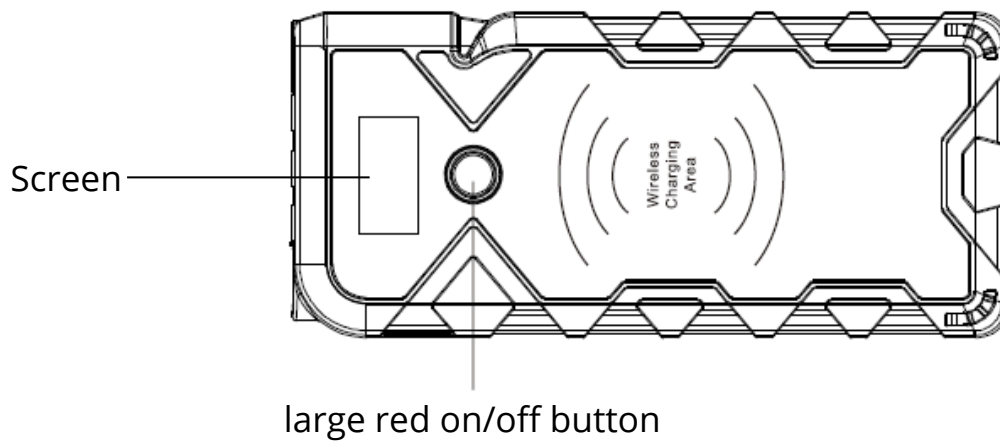

USER GUIDE

STATE OF CHARGE INDICATOR

To check the state of charge of your iTech2000A

- Turn the iTech2000A on by pressing the large red on/off button.
- The state of charge will be shown as a % on the screen.

USING THE TORCH

To use the torch on the iTech2000A

- Turn the iTech2000A on by pressing the large red on/off button.
- Double press the large red on/off button - the torch will turn on.
- Press the large red on/off button again to activate the strobe function.
- Press the large red on/off button again to activate the SOS function.
- Press the large red on/off button again to turn the torch off.

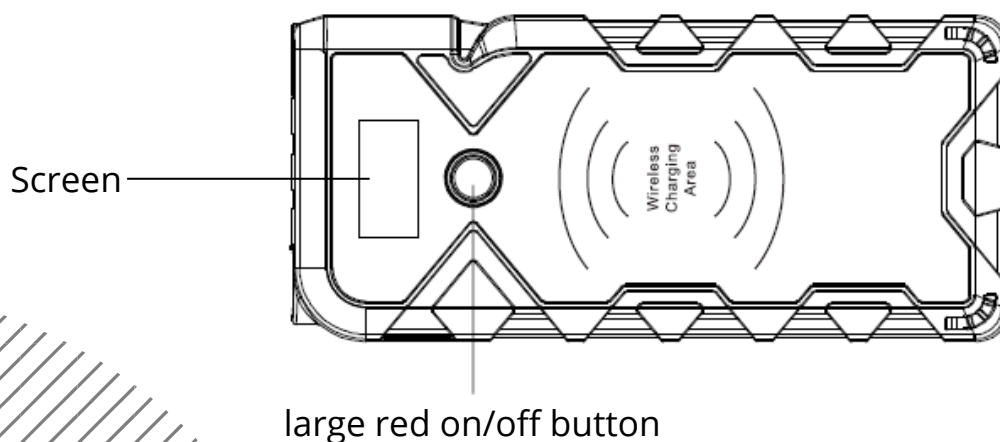



USER GUIDE

WIRELESS CHARGING

The iTech2000A is Qi charging ready. You can charge a Qi-enabled smart device wirelessly from the iTech2000A. Please check that your smart device is Qi-enabled before using this feature. If your device is not Qi-enabled it will not via the wireless charging zone.

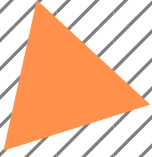
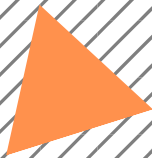
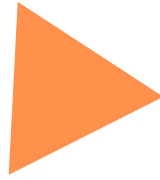
- Turn your iTech2000A by pressing the large red on/off button.
 - Place your Qi-enabled smart device on the wireless charging area.
 - The Qi-enabled smart device will now charge.
- 
- 
- 

USER GUIDE

CHARGING DEVICES

You can either use the provided USB split cable in the kit or the original USB cable that came with the device. Please note that some devices will require to use the original USB cable that came with the device.

Connect the cable into the iTech2000A's USB port.

Connect the device to the cable.

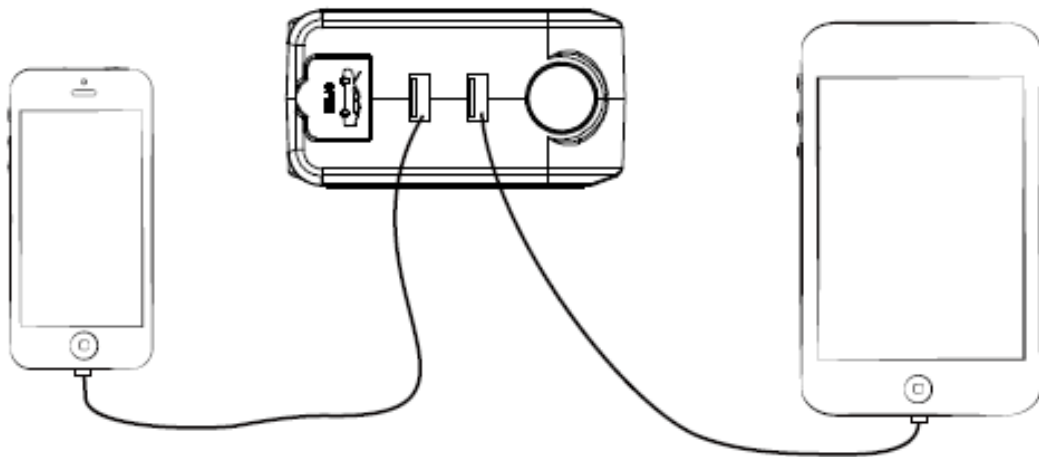







USER GUIDE

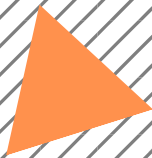

RUNNING A 12V DEVICE

The iTECH2000A is capable of running 12v devices such as a 12v fridge. Please note that not all 12v appliances are supported and some 12v appliances may require an EC5 adapter to operate on the iTECH2000A.

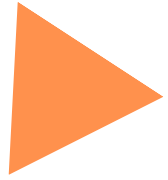
The 12v device must have a 12v male cigarette adapter to operate on the iTECH2000A. Any device which draws over 8a will automatically switch off the iTECH2000A.

- Turn the iTECH2000A on by pressing the large red on/off button.
 - Insert the 12v female cigarette socket (provided in the kit) into the 12v/8a out put port.
 - Insert the 12v device's male cigarette plug into the female cigarette socket.
 - If the device is compatible it will run via the iTECH2000A.
- 
- 
- 
- 

USER GUIDE

FREQUENTLY ASKED QUESTIONS

- How do I turn off the iTECH2000A

Press and hold the large red on/off button for 5-7 seconds.

- How long does the iTECH2000A take to charge

The iTECH2000A will take 4-5 hours to charge depending on the charging method, 12v or 240v.

- How many time can I jump start my vehicle from one full charge?

This depends on different vehicle sizes. Large diesels up to 5 times. Petrol vehicles up to 10 times.

- If not being used, how long will the iTECH2000A's charge last?

If the iTECH2000A is switched off the charge will last up to 3 months. If the iTECH2000A is switched on the charge will last less than 24 hours.

- My phone will not charge via Qi?

Ensure the iTECH2000A is switched on.

Ensure you have a Qi compatible phone.

Remove any phone case that may block or lower the charge rate.

Reposition the phone in the wireless charging area.

Only one device can be charged at a time via Qi.

USER GUIDE

FREQUENTLY ASKED QUESTIONS

- My fridge is not running as long as I expected

Ensure the fridges low voltage setting is set to "low".

Ensure the fridge is already cold.

Ensure there is no air gaps in the fridge. Fill air gaps with water bottles.

Ensure your fridge is not set to "freeze".

- My iTech2000A will not charge my phone as much as my other iTechworld battery bank.

When the iTech2000A is switched on, there is still active circuitry running, even if there is no devices connected to it, this includes the wireless charging pad, backlit screen, and voltage regulation for the USB ports, this consumes power. The iTech2000A operates differently from other battery banks as the battery pack is at 16 volts, this decreases the usable capacity. Also, the iTech2000A is designed as a jump starter primarily and functions as battery bank as a secondary feature.

- How can I prolong the life of my iTech2000A



Check & charge your iTech2000A every two months. Always turn the iTech2000A off after use. Do not leave the iTech2000A at 0% charge for longer than 7 days. Do not leave the iTech2000A exposed to direct sunlight. Store the iTech2000A in a cool & dry environment away from heat and water. Do not attempt to use, charge or discharge the iTech2000A any other way than what has been stated in this user guide document.



USER GUIDE

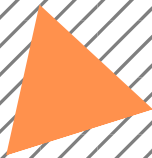

JUMP STARTING CHECK LIST

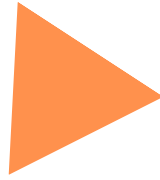
- Read and understand this user guide in full.
 - Prepare the iTECH2000A correctly. (Clamps into the iTECH2000A first then connect to the car battery)
 - Ensure the iTECH2000A has more than 80% state of charge.
 - Ensure the car battery terminals are clean and free from corrosion
 - Ensure all 12V accessories (eg radio, fridge.), and headlights are turned off before attempting to jump start.
 - Ensure both sides of the alligator clamps are firmly touching the car battery terminals.
 - Ensure the small circle button located on the hand piece of the clamps has been pressed before attempting to start the vehicle.
 - Note the countdown on the screen of the clamps.
 - Start the vehicle before the countdown reaches zero.
- 
- 
- 





USER GUIDE



TROUBLE SHOOTING

If the iTech2000A is not functioning correctly, please contact iTechworld on 1300 483 249.

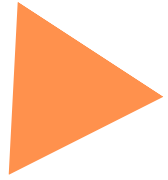

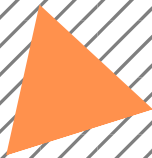











PROBLEM	CAUSE	SOLUTION
The power capacity is showing 100% but the unit did not fully charge.	The LCD screen shows fully charged, stop charging. This means the unit is in a semi state of charge due to long term storage.	Pull out the charging plug and reconnect.
Nothing happens when I press the round power button	The unit is in low voltage protection mode and cannot be turned on.	Insert the charger plug into the 9V/2A input port to activate.



USER GUIDE

WARNING!

1. After starting your vehicle, REMOVE the ITECH2000A as soon as possible.
2. DO NOT connect the 2 alligator clips together.
3. DO NOT disassemble the ITECH2000A

-  Do not use the product in bathroom or other damp places or places near the water.
-  Do not remodel or dismantle the device.
-  Keep the product away from the children.
-  Do not reverse the connections of output or input.
-  Do not throw the product into fire.
-  Only use original charger.
-  The temperature should be kept between 0°C to 40°C when the device is being charged.
-  Do not hit or throw the product.
-  If there is problem with charging, please contact ITECHWORLD.
-  Keep the product away from the flammable objects (Bed or carpet)
-  If the liquid of the device is splashed into eyes, do not wipe the eyes but wash them with clean water immediately.
-  If the product is heating and discolouring, please stop using, as it may lead to liquid, smoke and flames.
-  After long term storage or not in use, please ensure that devices will be charged and discharged every three months.
-  Do not leave in direct sunlight.



QUALITY COMMITMENT
2 MILLION USD SUM

STANDARD: GB/T 18287-2000

Our product's quality is underwritten by Allianz Property and
Casualty Company Limited



ROHS

CE

FC

WARRANTY

YOUR RECEIPT SHOULD BE RETAINED BY YOU AT ALL TIMES. IN ORDER TO CLAIM ANY WARRANTY, YOU MUST RETURN THE PRODUCT TO YOUR NEAREST ITECHWORLD (SEE WWW.ITECHWORLD FOR STORE LOCATION) WITH YOUR ITECHWORLD RECEIPT. PRIOR TO RETURNING YOUR PRODUCT FOR WARRANTY PLEASE TELEPHONE OUR CUSTOMER SERVICE HELPLINE

Australia 1300 483 249

TO ENSURE A SPEEDY RESPONSE PLEASE HAVE THE RECEIPT NUMBER AND DATE OF PURCHASE AVAILABLE. A CUSTOMER SERVICE REPRESENTATIVE WILL TAKE YOUR CALL AND ANSWER ANY QUESTIONS YOU MAY HAVE RELATING TO THE WARRANTY POLICY OR PROCEDURE.

1 YEAR WARRANTY

Your product is guaranteed for a period of 12 months from original date of purchase. If a product is defective it will be repaired in accordance with the terms of this warranty.

The benefits provided under this warranty are in addition to other rights and remedies which are available to you under law. The warranty covers manufacturer defects in materials, workmanship and finish under normal use.

Our goods come with guarantees that cannot be excluded under Australian Consumer law and Consumer Guarantees Act 1993 (NZ). You are entitled to a replacement or refund for a major failure. You are also entitled to have the goods repaired or replaced if the goods fail to be of acceptable quality and the failure does not amount to a major failure.