

# 1

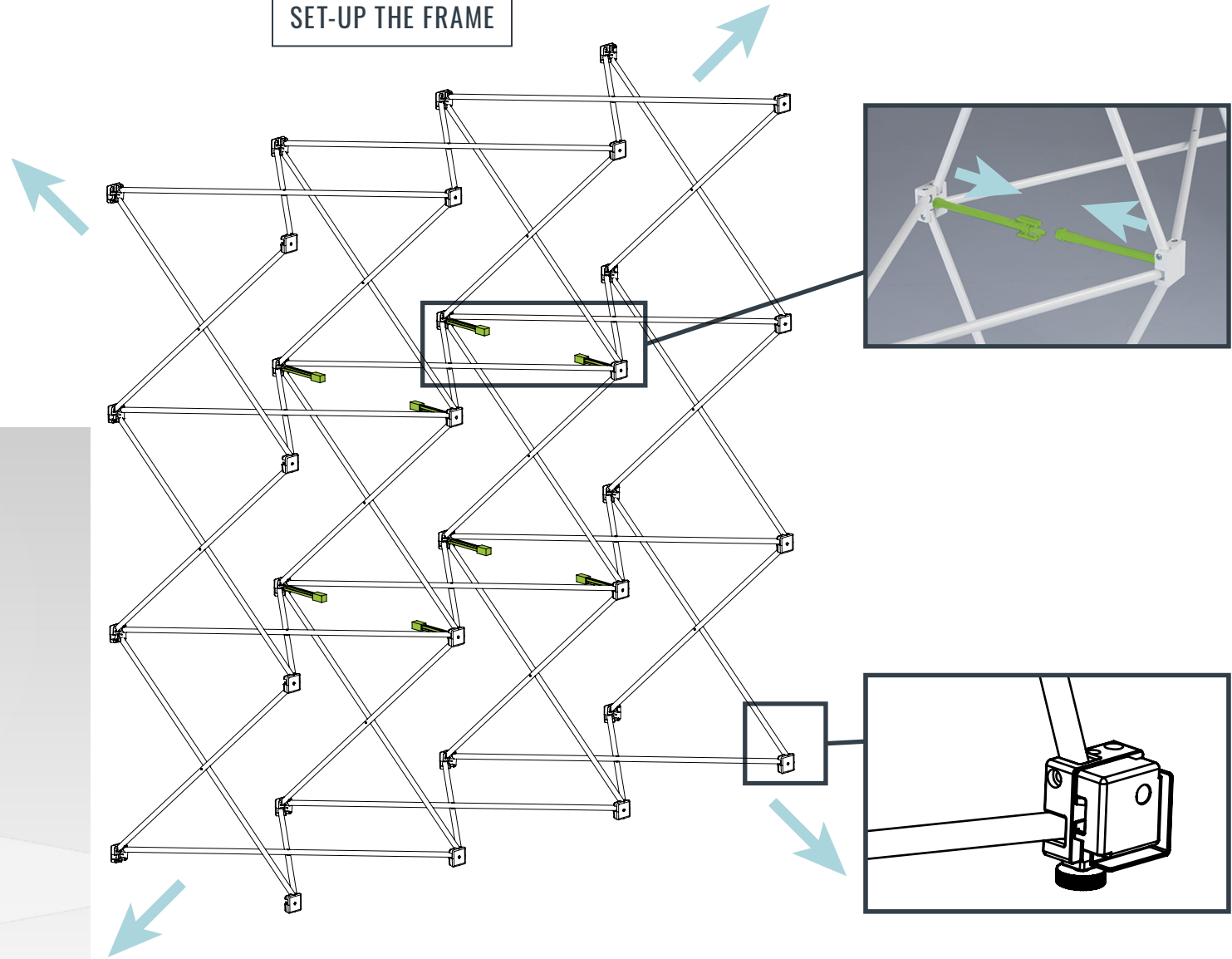

SET-UP THE FRAME



## 2

### INSTALL THE CHANNEL BARS

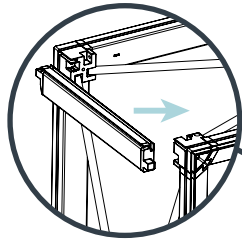

groove towards the top

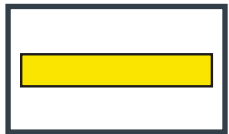
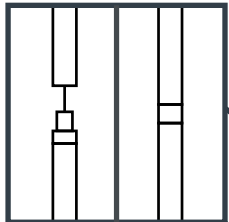

**NOTE:** The back horizontal channel bars are included with the backlit xperience frames. However, they must be ordered separately for double-sided straight or curved Xperience frames

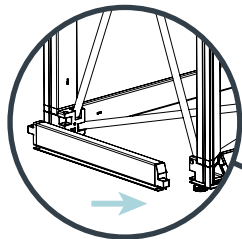

groove towards the floor

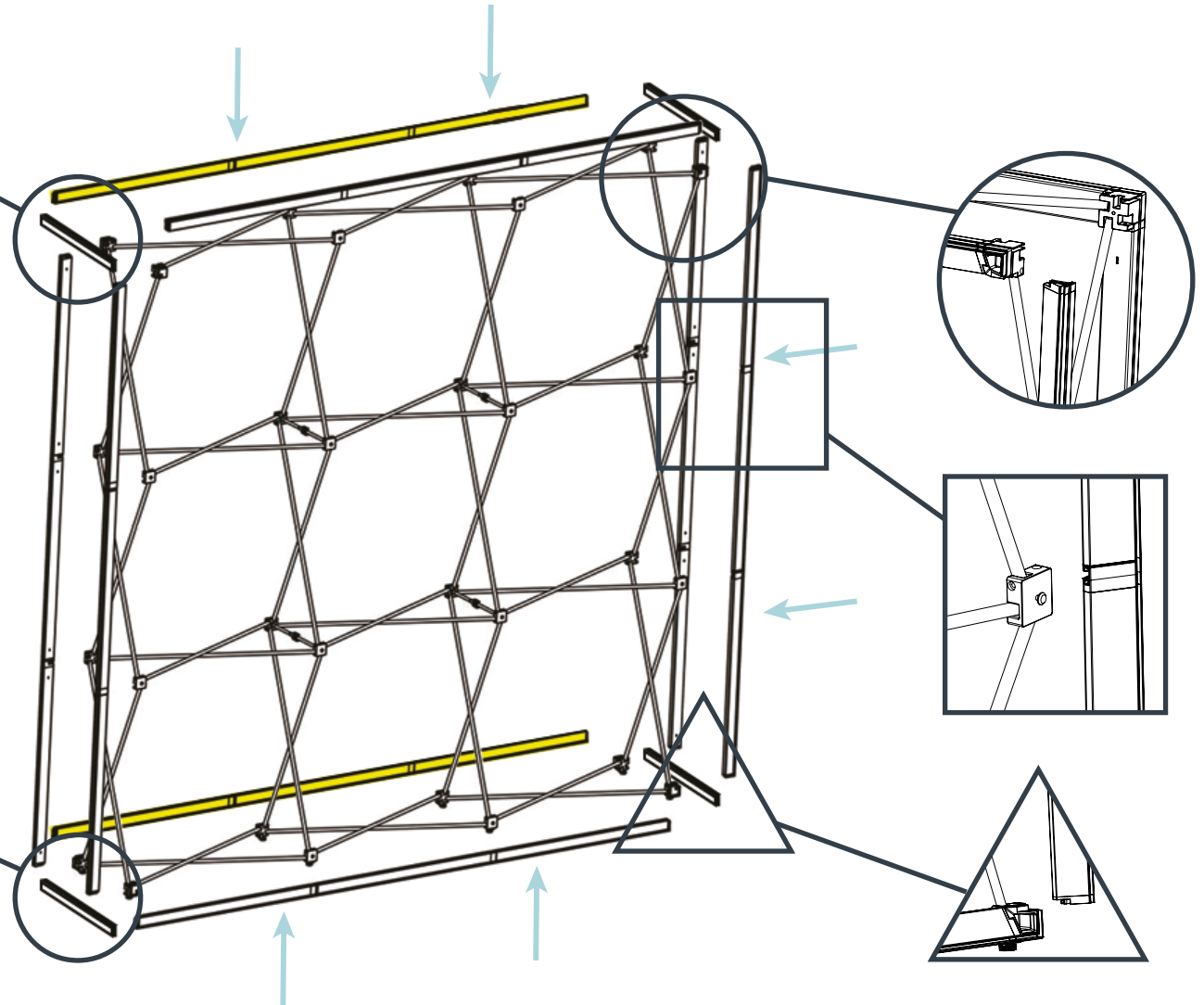

## INSTALLING THE LED LIGHT CURTAINS

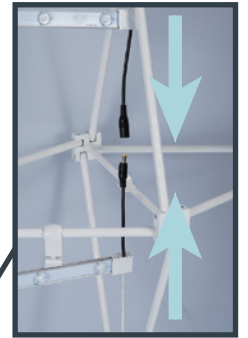
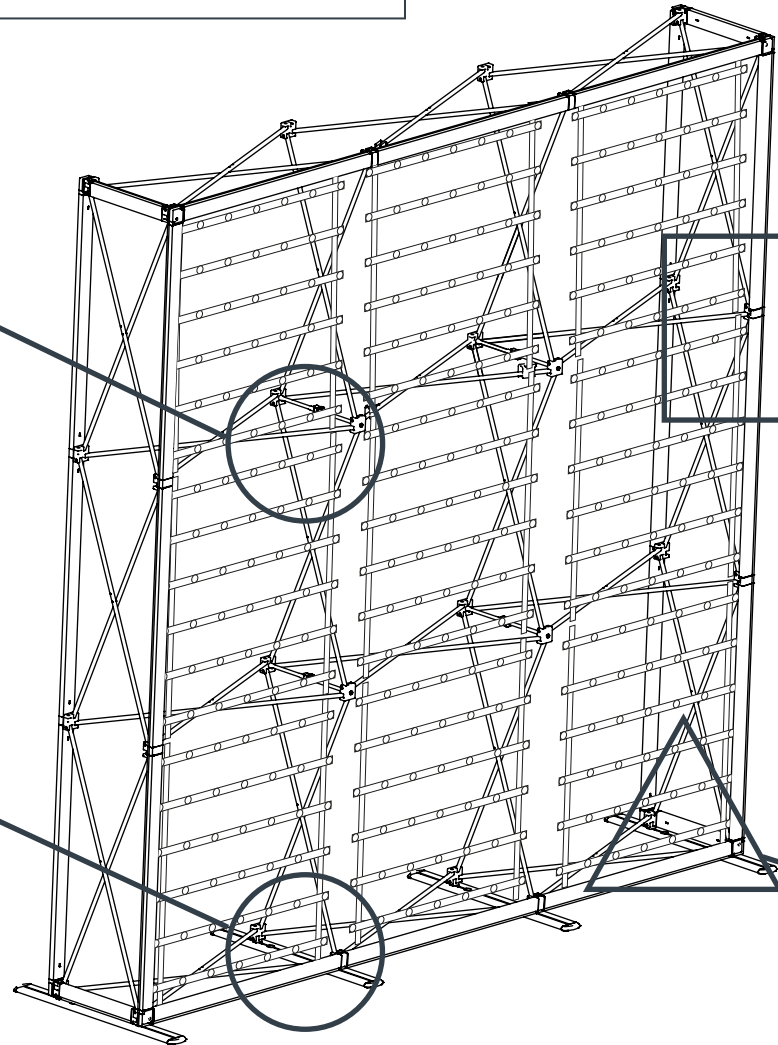
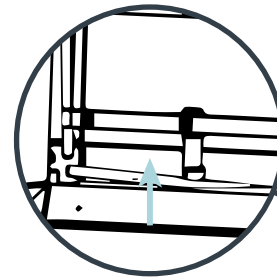
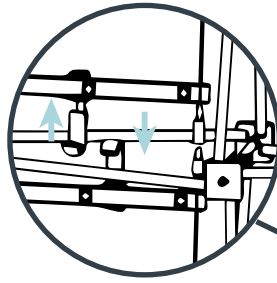
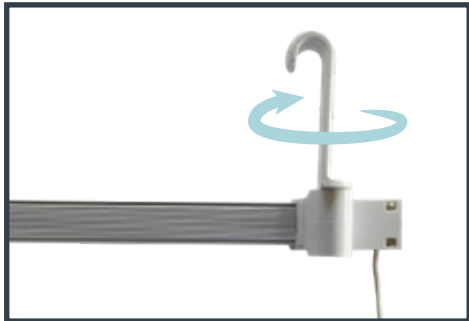
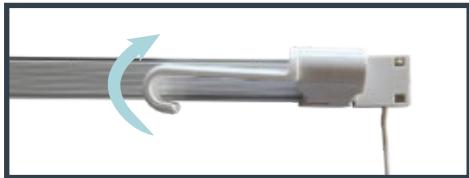

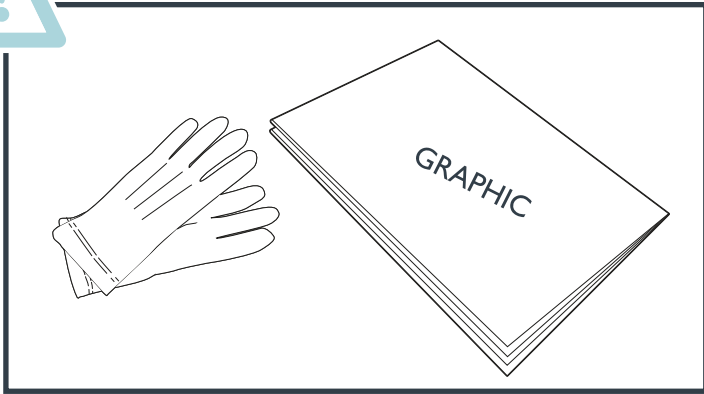

## INSTALLING THE GRAPHIC

