



2nd Semester  
2019

# panoramic<sup>®</sup>

## h-line

2019 RETAIL PRICING

“

Each panel has a function, with infinite possibilities for personalization

”

panoramic<sup>®</sup>  
h-line

*The prices provided in this catalog are suggested retail prices excluding VAT. We are constantly improving and adding to our product range, and we reserve the right to modify their specifications and prices without prior notice.*

*Despite the attention given to the production of this document, it may contain errors and omissions for which the catalog distributor cannot be held responsible. Only the final estimate is deemed as accurate.*

*We also invite you to read the General Sales Terms and Conditions provided by the distributor of this catalog. All logos and trademarks used or mentioned on this page are the property of their respective owners and are used for display purposes only.*

# 3

## Pre-assembled modules

Modular exhibits



# 4 Concept

Modular exhibits



- Panoramic h-line is a trade show display system which allows you to easily create a custom exhibit using pre-assembled modules.
- With its full surface area completely dedicated to the graphic image, Panoramic h-line creates an unparalleled visual impact while also providing a full assortment of useful functionalities.
- Panoramic h-line is a perfect solution for those that would like an exhibit that is both modular and flexible for purchase or rental.

# Benefits

## Five reasons to choose panoramic h-line

- Showcase your image  
Put the graphic image front and center! No visible aluminum profile means your message is even more effective and your exhibit carries a **true mark of quality**.
- Endless modularity  
All module types can be connected to one another - no restrictions! **Rest assured that you can use your exhibit in every space**, even those you have yet to consider. Panoramic h-line is a completely scalable solution that grows along with your company.
- Focus on the essentials!  
Each module has been designed to provide its own unique functionality (communicate, display, design, spread your message, store, and welcome customers). **You can pre-fit certain modules by adding optional kits for even more functionality.**
- Be creative!  
Distinguish your company by creating your own custom graphic or use our database of colors and patterns specifically chosen for Panoramic h-line. **Put a part of yourself in your exhibit!**
- CLEVER & SIMPLE  
Panoramic h-line requires **zero technical expertise** and is set-up without the use of tools. Set-up up the exhibit yourself, or with our assistance. Standard modules do not exceed a weight of 19 lbs. Set-up for a 20' x 10' exhibit takes less than 1 hour for 1 person.

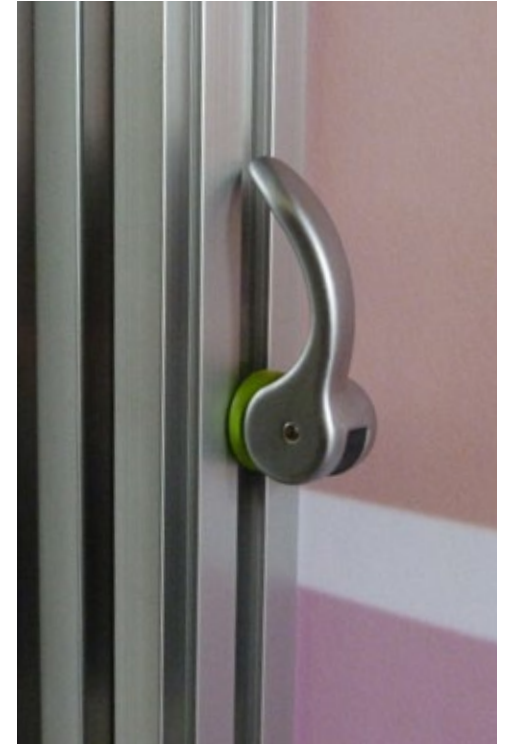

# 6 Concept

Formats

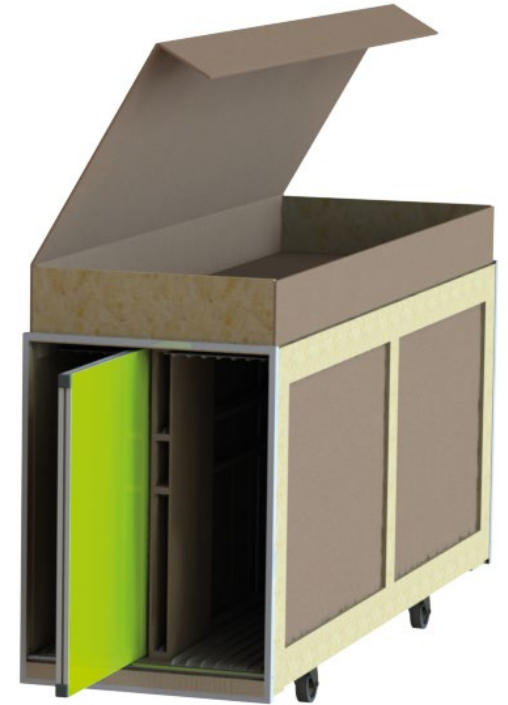

3 modules sizes:  
9.5", 19" and 38"

Every panel is delivered with pre-installed graphics, just connect them!

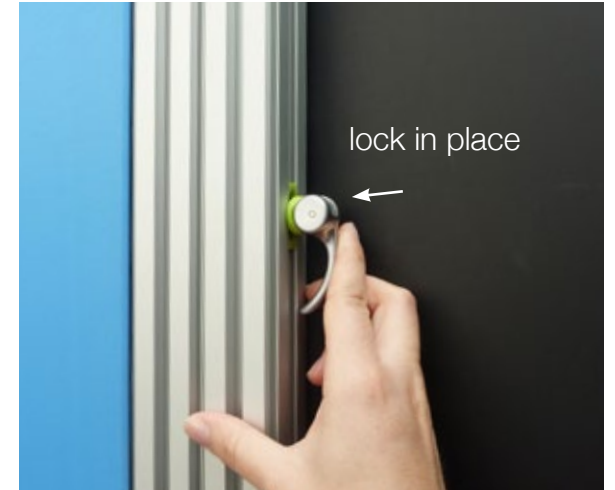

All module types can be connected to one another



Result: no visible aluminum profile!

# 8 Graphics

- Dye-sublimated fabric graphics
- Features a silicone edge (SEG) attachment system, in which silicone is sewn into the edge of the graphic and is then inserted into the groove of the Panoramic profile.
- Extremely precise graphic dimensions ensure perfect graphic tension upon installation
- The right fabric for each use: opaque Panopac fabric for maximum visual impact and optimal color rendering, light-diffusing fabric for lightboxes and backlit frames
- Easy to transport and ship

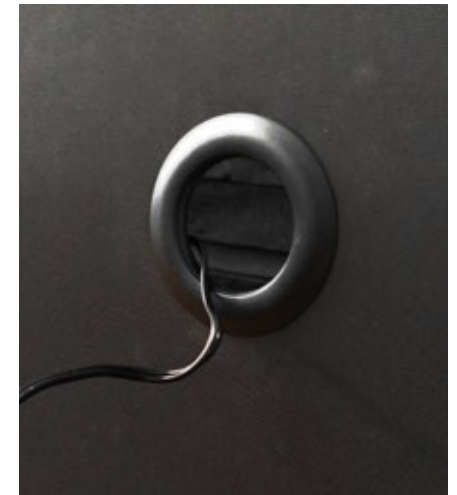

Grommets provide optimal and durable cable management



9

# 100% modular:

13 modules, 4 shows, 4 configurations, 4 locations

Reconfigure your h-line exhibit to suit your event, using the same pack of modules each time

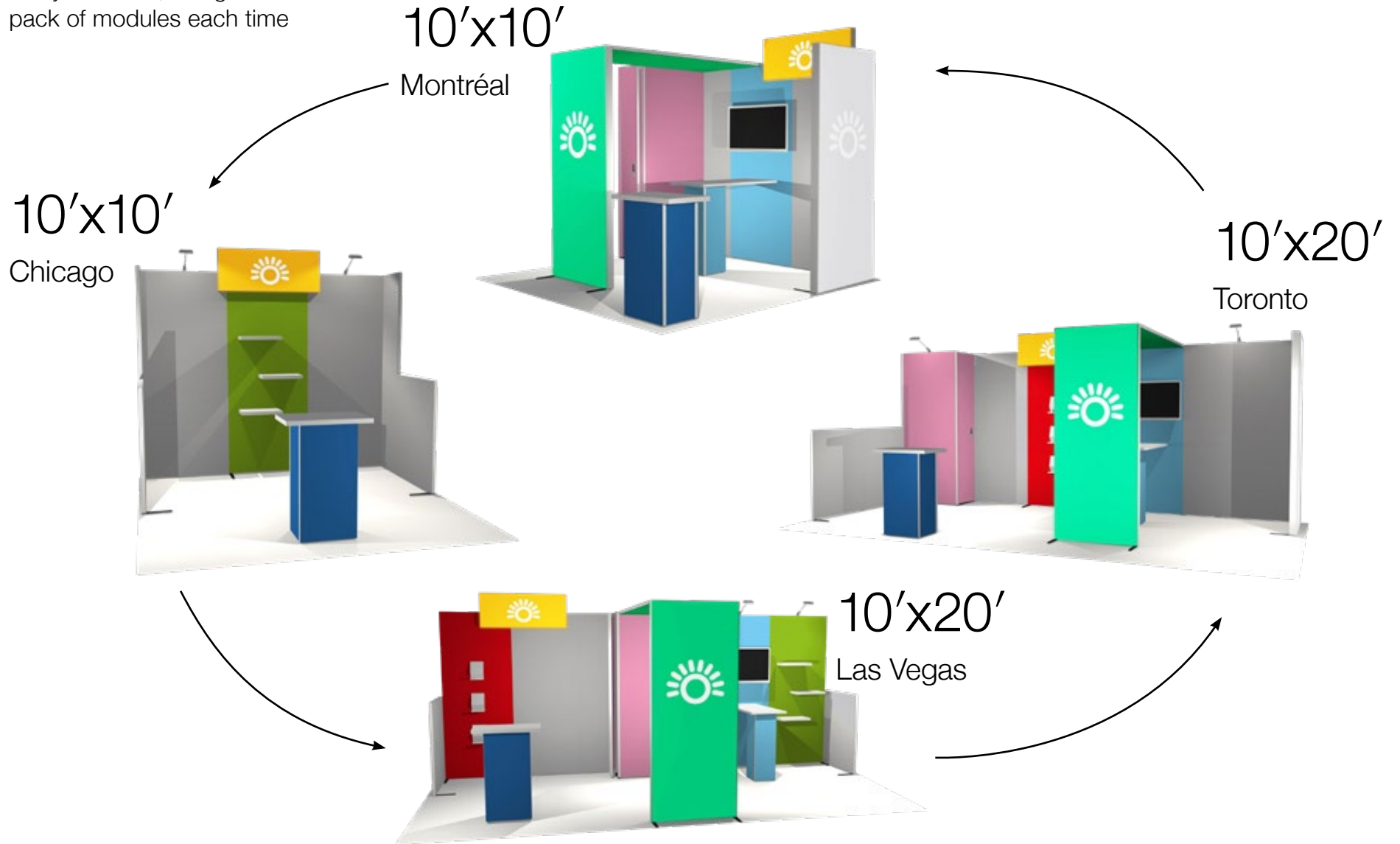

# 10 100% modular: 13 modules for an unlimited number of configurations!

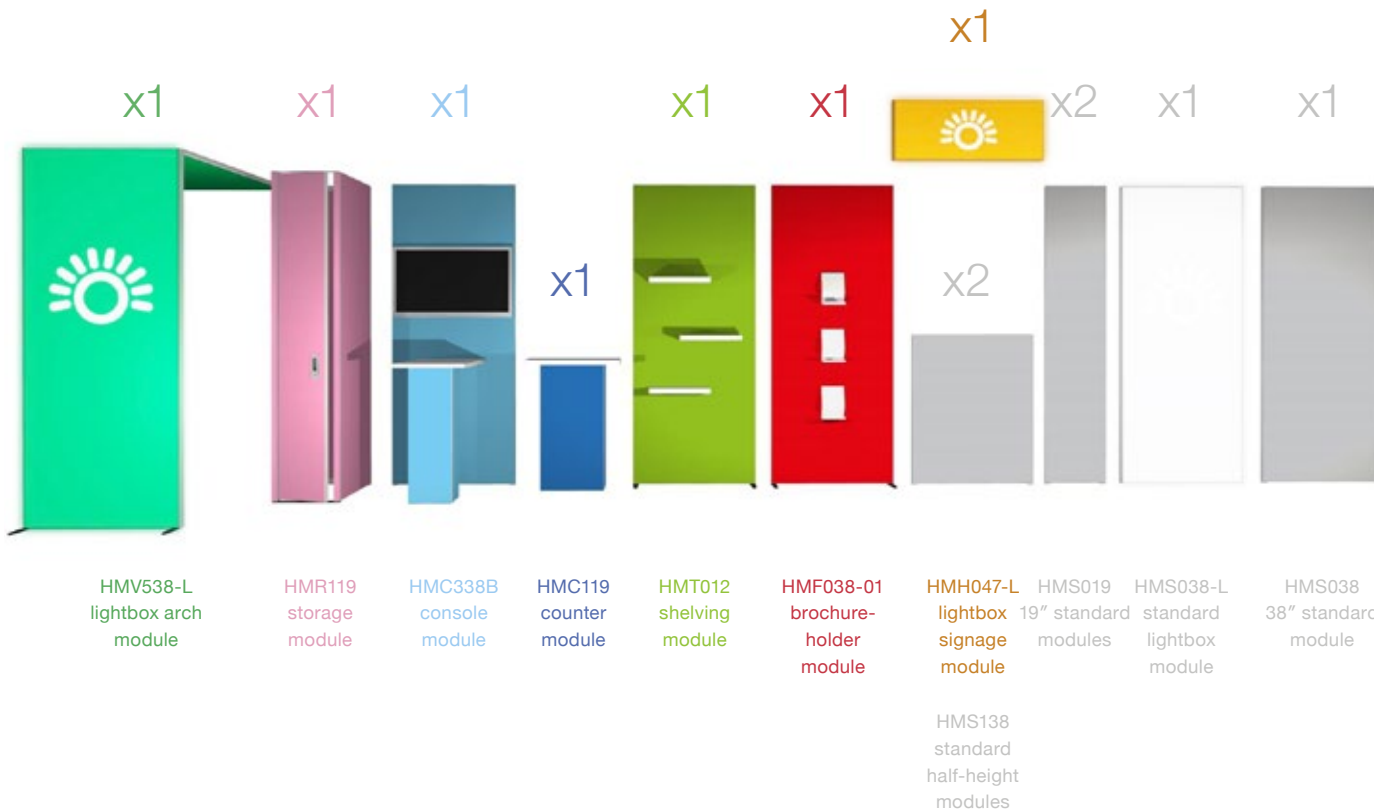

## 13 module pack

- 1 HMS038 standard module
- 1 HMS038-L standard lightbox module
- 2 HMS019 standard modules
- 2 HMS138 standard half-height modules
- 1 HMF038-01 brochure-holder module
- 1 HMC338B console module
- 1 HMT012 shelving module
- 1 HMC119 counter module
- 1 HMR119 storage module
- 1 HMH047-L lightbox signage module
- 1 HMV538-L lightbox arch module
- 1 SOS kit
- 2 LED lights
- 1 H3 crate

Purchase\* from **\$ 20,000**

Initial investment for 4 events

Price **\$ 5,000**

for each event from

Rental\* from **\$ 9,100**

*\*TV not included in price.*

*Rental price includes custom-printed graphics.*



- Modular exhibits, ideal for 10'x10', 10'x20', 10'x30' and 20'x20' spaces
- Packaged in a wheeled crate, with frames and graphics preassembled
- May be set up with or without professional assistance

# modular exhibits



### h10-03

Structures + graphics + counter  
+ 2 LED lights + packaging

Purchase\* from **\$ 8,100**

Rental from **\$ 4,100**

\*furniture and printed carpet not included

Option (unit price)

	Purchase
printed carpet	
<b>panofloor</b>	<b>\$ 1,000</b>

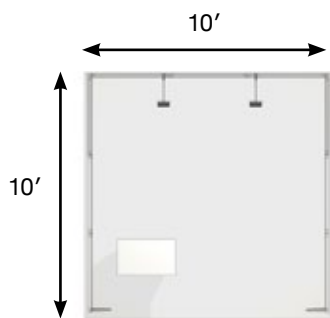

standard height 93"



HMC119 counter



LED light



Simply add 3 more standard 38" modules to turn it into a 10'x20' exhibit

\* Rental price includes custom-printed graphics.



## h10-06

Structures + graphics + counter  
+ 2 LED lights + packaging

Purchase\* from \$ **14,600**

Rental from \$ **6,000**

\*TV screen, furniture and printed carpet not included

Option (unit price)

	Purchase
printed carpet	
<b>panofloor</b>	<b>\$ 1,000</b>

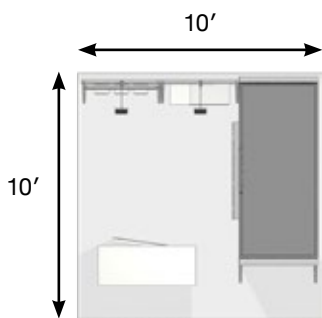

standard height 93"



HMC038 counter with USB hub



Add new modules and accessories to create a customized 10'x20' exhibit

Display your items on shelves



### h10-07

Structures + graphics + counter + packaging

Purchase\* from \$ **14,800**

Rental from \$ **6,600**

\*TV screen, furniture and printed carpet not included

Option (unit price)

	Purchase
printed carpet	
<b>panofloor</b>	<b>\$ 1,000</b>

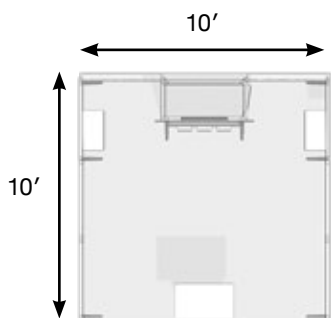

3 brochure holders module + TV (HMM638)

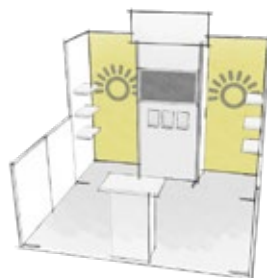

Add 2 38" lightbox modules and 2 standard 19" modules to create a 10'x20' exhibit

\* Rental price includes custom-printed graphics.

Create storage with the closet module



## h20-12

Structures + graphics + counter + packaging

Purchase\* from \$ **13,000**

Rental from \$ **6,600**

\*furniture and printed carpet not included

Option (unit price)

	Purchase
printed carpet	
<b>panofloor</b>	<b>\$ 2,000</b>

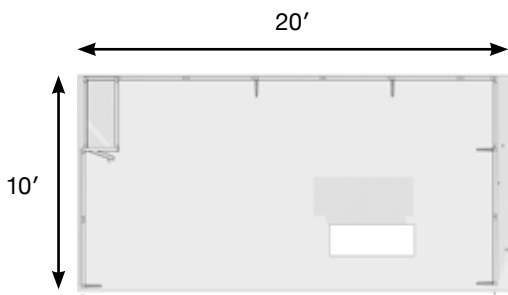

standard height 93"



HMC038 counter

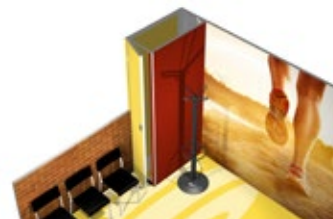

HMR119 storage module



Remove modules and adapt to a smaller area: 10'x10'

\* Rental price includes custom-printed graphics.

Increase visibility with a header



## h20-28

Structures + graphics + counter  
+ 4 LED lights + packaging

Purchase\* from \$ **22,000**

Rental from \$ **9,900**

\*TV screen, furniture and printed carpet not included

Option (unit price)	Purchase
printed carpet	
<b>panofloor</b>	<b>\$ 2,000</b>

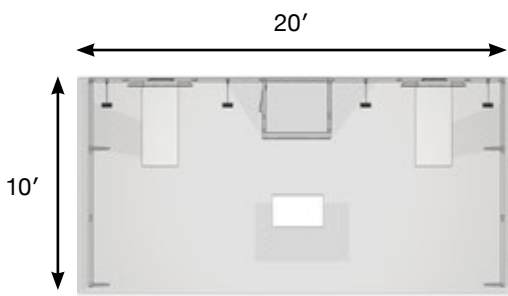

standard height: 93"  
header height: 38"



interior shelf in each console

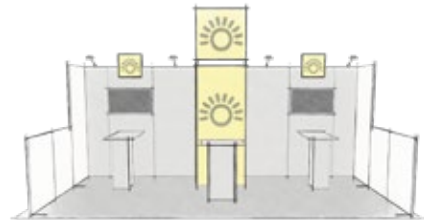

Ôtez des modules et adaptez-vous à une surface plus petite : 10'x10'

\* Rental price includes custom-printed graphics.





## h20-24

Structures + graphics + counters  
+ 3 LED lights + packaging

Purchase\* from \$ **25,400**

Rental from \$ **11,900**

\*TV screen, furniture and printed carpet not included

Option (unit price)	Purchase
printed carpet	
<b>panofloor</b>	<b>\$ 2,000</b>

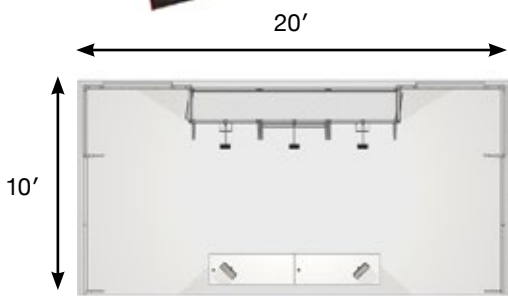

standard height: 93"  
header height: 38"



brochure holders and TV



2 HMC038-USB counters  
connected with HMC003



Add header modules to transform your exhibit into  
a central 20'x20' island

\* Rental price includes custom-printed graphics.

Vary your messages with wall.frame



## h20-26

Structures + graphics + counters + packaging

Purchase\* from \$ **19,000**

Rental from \$ **9,100**

\*TV screen, furniture and printed carpet not included

Option (unit price)

	Purchase
printed carpet	
<b>panofloor</b>	<b>\$ 2,000</b>

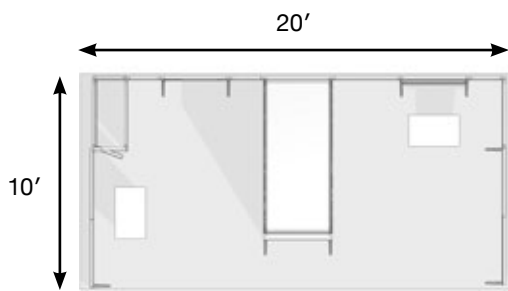

standard height: 93"



storage module HMR119



Increase the size of your exhibit to 10'x30': add 1 storage module, 1 arch and 1 counter



## h20-29

Structures + graphics + counters  
+ 5 LED lights + packaging

Purchase\* from \$ **27,800**

Rental from \$ **13,300**

\*TV screen, furniture and printed carpet not included

Option (unit price)	Purchase
printed carpet	
<b>panofloor</b>	<b>\$ 4,000</b>

Connect two counters using the connection module

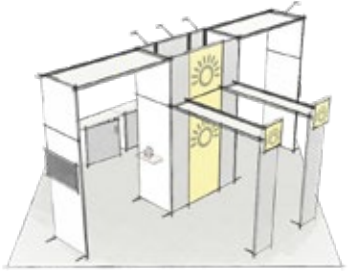
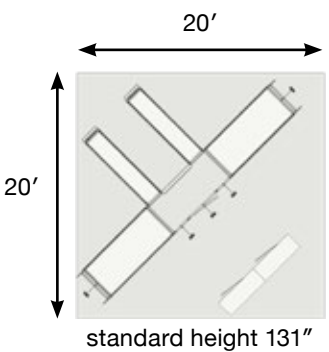

Add 2 standard 38" modules, 1 19" module and 1 9" module to change the layout of your exhibit to 10'x20'

\* Rental price includes custom-printed graphics.

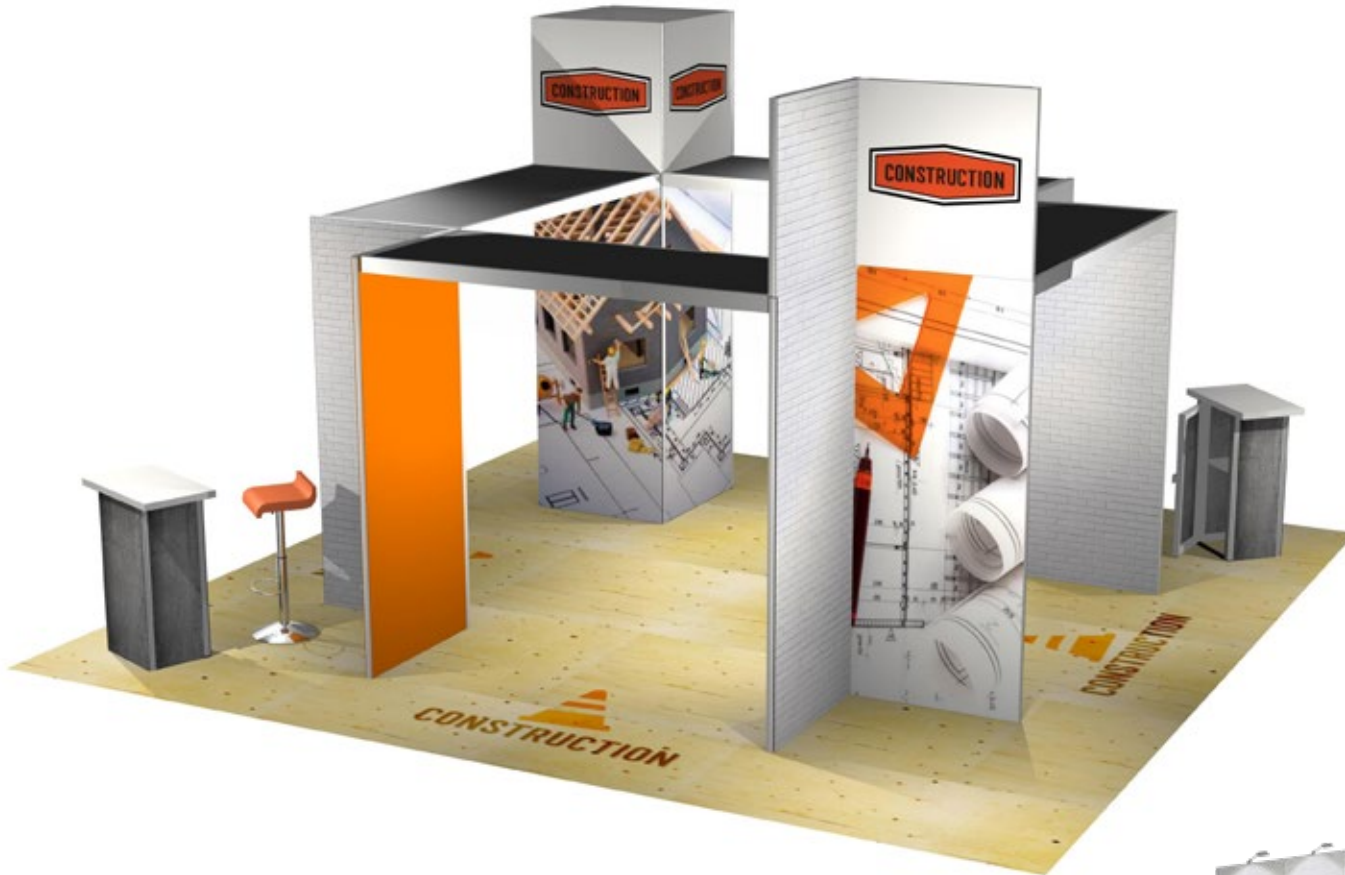

## h20-10

Structures + graphics + counter + packaging

Purchase\* from \$ **26,700**

Rental from \$ **13,500**

\*TV screen, furniture and printed carpet not included

Option (unit price)	Purchase
printed carpet	
<b>panofloor</b>	<b>\$ 4,000</b>

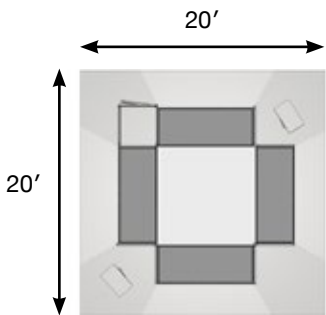

standard height 131"



arch module with lightbox velum HMV438-L

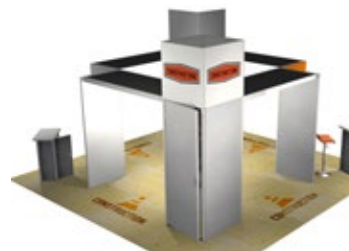

HMR038 storage module

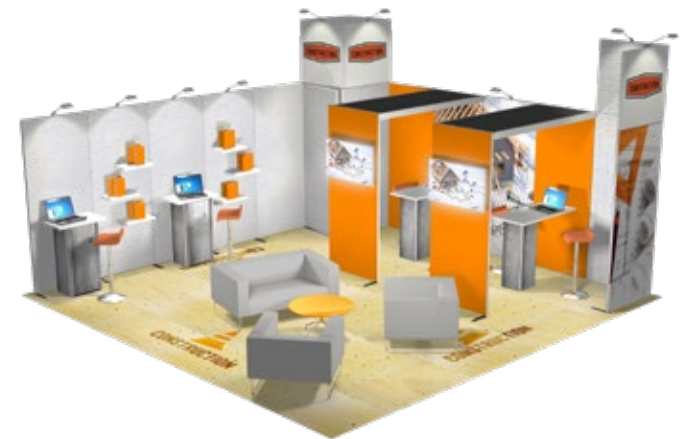

Create a very different design using the same area and more functionalities

\* Rental price includes custom-printed graphics.

Showcase your products with the helix.200 display case (see catalog)



## h30-02

Structures + graphics + counter + 6 LED lights + packaging

Purchase\* from \$ **31,500**

Rental from \$ **15,000**

\*TV screen, furniture and printed carpet not included

Options (unit prices)	Purchase
printed carpet	
<b>panofloor</b>	\$ <b>3,000</b>
display case	
<b>helix.200</b>	\$ <b>1,450</b>



30'

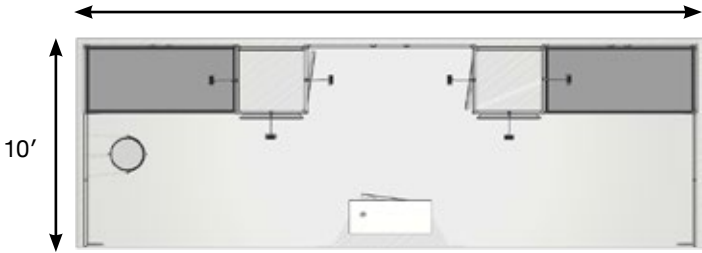

standard height: 93"



grid module to attach various accessories



Remove modules and adapt your exhibit to a smaller area: 10'x20'

\* Rental price includes custom-printed graphics.

# 22 Standard modules

Communicate



MODULES

**HMS001**  
Angled pole\*

Purchase (no graphic)    \$ **85**

Rental (no graphic)    \$ **26**

GRAPHICS

Dye-sub graphic only to wrap  
an exterior angle\*\*    \$ **50**

**Dimensions**

3.15"x93"

**HMS009**  
Standard module 9.5"  
+ dye-sub graphic

Purchase    \$ **381**

Rental\*    \$ **174**

Dye-sub graphic only    \$ **85**

**HMS019**  
Standard module 19"  
+ dye-sub graphic

Purchase    \$ **491**

Rental\*    \$ **256**

Dye-sub graphic only    \$ **155**

**HMS038**  
Standard module 38"  
+ dye-sub graphic

Purchase    \$ **691**

Rental\*    \$ **417**

Dye-sub graphic only    \$ **300**

\* Rental price includes custom-printed graphics. \*\* To be included in addition to the angled pole price for a complete module

# 23 Standard modules

Communicate

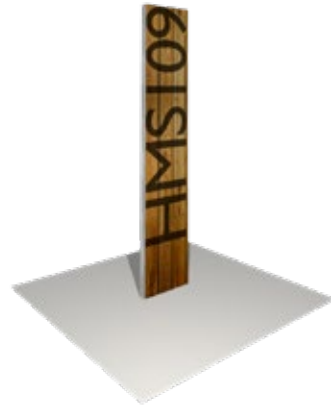
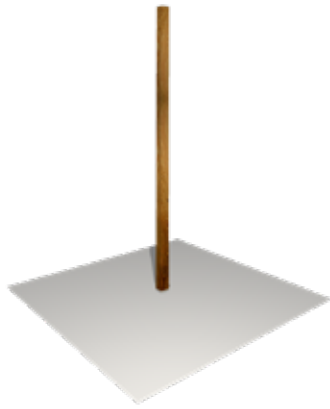

MODULES	HMS101	
	Half-height angled pole + dye-sub graphic	
	Purchase (no graphic)	\$ <b>42</b>
	Rental (no graphic)	\$ <b>13</b>
GRAPHICS	-----	
	Dye-sub graphic only	\$ <b>30</b>
	-----	
	<b>Height:</b>	
	46.5"	

HMS109	
Half-height standard module 9.5' + dye-sub graphic	
Purchase	\$ <b>241</b>
Rental*	\$ <b>121</b>
-----	
Dye-sub graphic only	\$ <b>70</b>
-----	
<b>Height:</b>	
46.5"	

HMS119	
Half-height standard module 19" + dye-sub graphic	
Purchase	\$ <b>266</b>
Rental*	\$ <b>139</b>
-----	
Dye-sub graphic only	\$ <b>85</b>
-----	
<b>Height:</b>	
46.5"	

HMS138	
Half-height standard module 38" + dye-sub graphic	
Purchase	\$ <b>396</b>
Rental*	\$ <b>227</b>
-----	
Dye-sub graphic only	\$ <b>155</b>
-----	
<b>Height:</b>	
46.5"	

\* Rental price includes custom-printed graphics.

# 24 Storage modules

Store

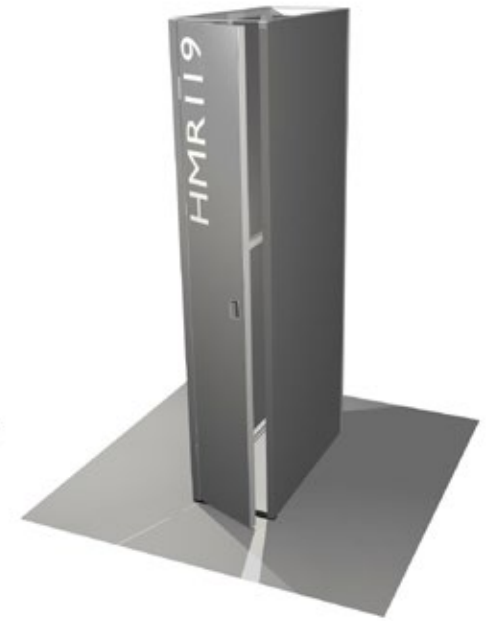

MODULES

**HMR038**  
Storage module 38"x38"  
+ dye-sub graphics

Purchase           **\$ 3,074**  
Rental\*           **\$ 1,794**

**HMR138**  
Storage module 38"x76"  
+ dye-sub graphics

Purchase           **\$ 4,456**  
Rental\*           **\$ 2,628**

**HMR019**  
Closet module 19"x19"  
+ kit of 2 shelves + dye-sub graphics

Purchase           **\$ 2,384**  
Rental\*           **\$ 1,171**

**HMR119**  
Closet module 19"x38"  
+ dye-sub graphics

Purchase           **\$ 2,649**  
Rental\*           **\$ 1,453**

GRAPHICS

Dye-sub graphics only   **\$ 1,245**

Dye-sub graphics only   **\$ 1,845**

Dye-sub graphics only   **\$ 650**

Dye-sub graphics only   **\$ 940**

Accessorize : add optional accessory kits to furnish your storage modules

\* Rental price includes custom-printed graphics.



# 25 Door modules

Store



More ergonomic and stylish door handle



MODULES

**HMP019**  
Door module 19"  
+ dye-sub graphics

Purchase            \$ **802**

Rental\*             \$ **370**

GRAPHICS

-----  
Dye-sub graphics only \$ **185**

**HMP038**  
Door module 38"  
+ dye-sub graphics

Purchase            \$ **1,027**

Rental\*             \$ **550**

-----  
Dye-sub graphics only \$ **345**

\* Rental price includes custom-printed graphics.

# 26 Standard lightbox module – 3.15" thick

Communicate

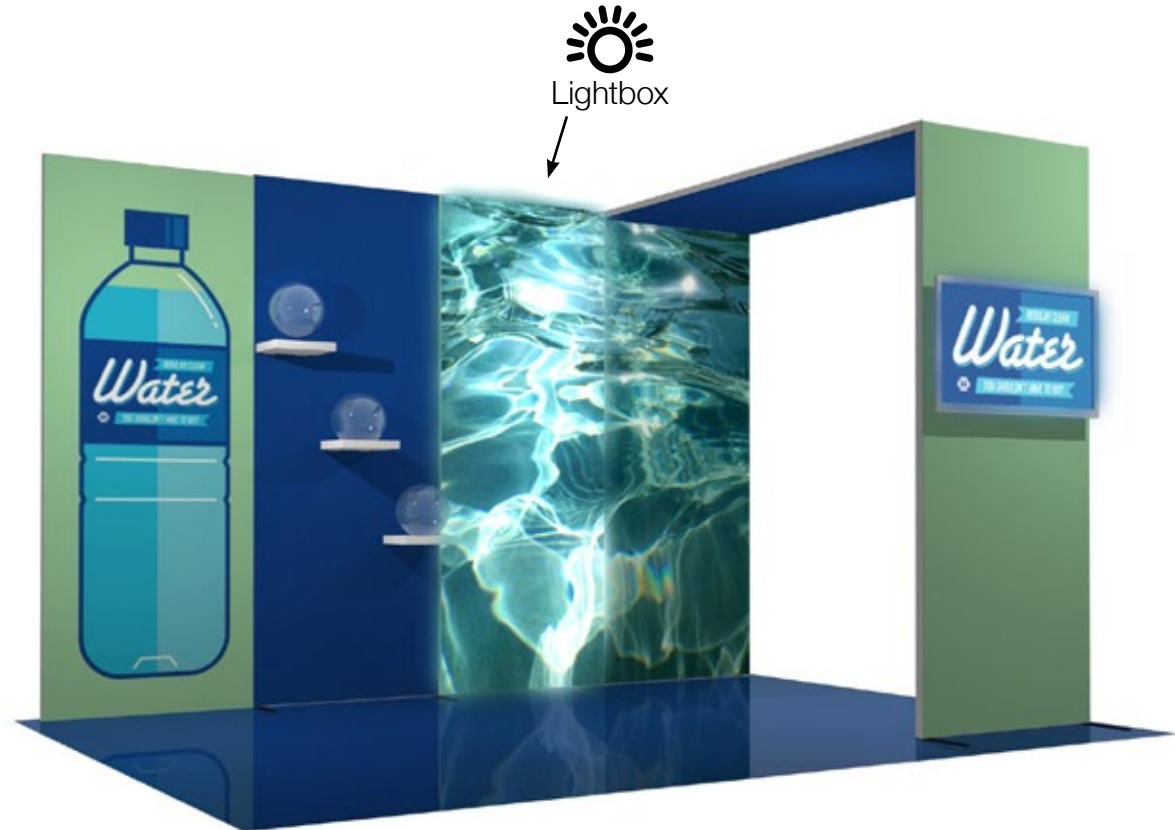
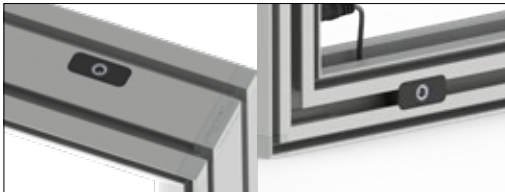
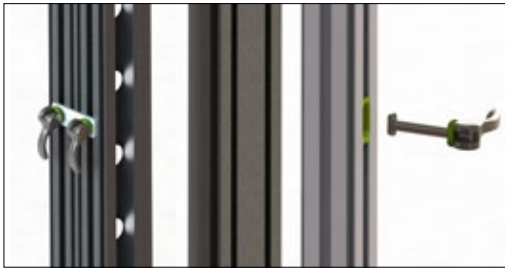
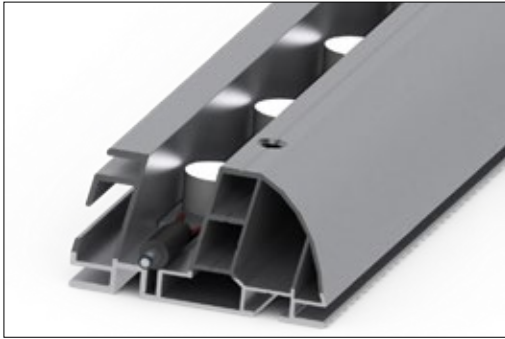

Lightbox

- Stand out!
- Perfect uniformity, without any light leakage
- Connects to all Panoramic H-Line panels
- 2 outlets on each module: no more worrying about configurations!
- Ships in the H-Line crate with the graphic pre-installed



# 27 Standard lightbox module – 3.15" thick

Communicate



MODULES

HMS038-L  
Standard Lightbox module 38"  
+ dye-sub graphic

Purchase \$ **1,994**  
Rental\* \$ **808**

GRAPHICS

Dye-sub graphic only \$ **300**

Also available double-sided  
but with only one backlit  
side.

\* Rental price includes custom-printed graphics.

Lightbox ships with standard connectors.  
Power supply bracket not included.

# 28 New standard lightbox module - 1.57" thick

Communicate

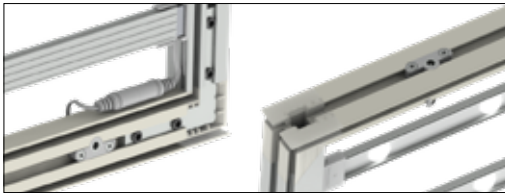
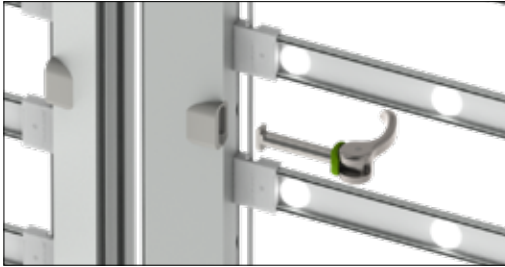
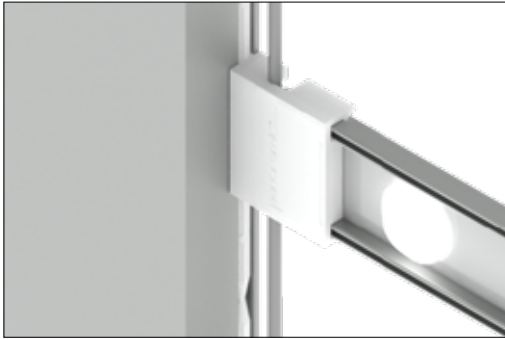

- New 1.57" thick, identical to non-backlit panels
- Perfect uniformity, without any light leakage
- Attaches to all panoramic h-line panels with one connector
- 2 outlets on each module: no more worrying about configurations!
- Shipped in h-line crate in a single slot with the graphic attached

# 29 New standard lightbox module - 1.57" thick

Communicate

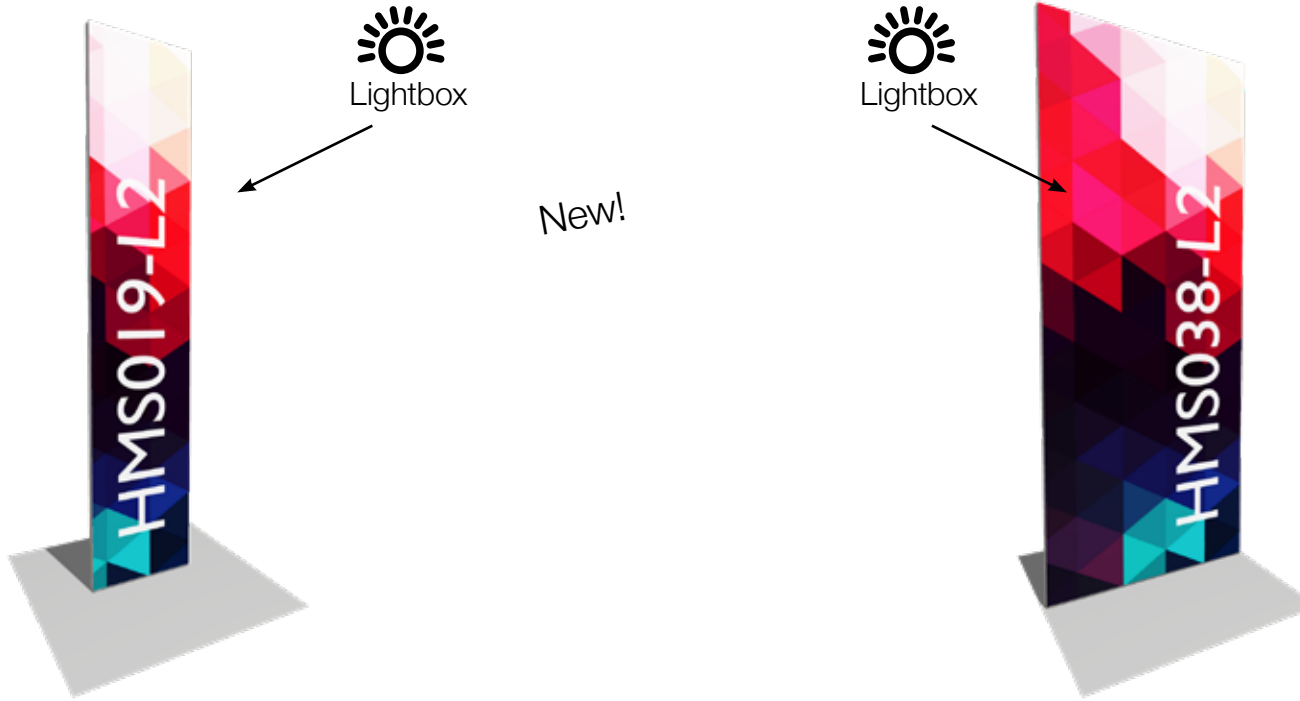

Also available double-sided but with only one backlit side.

MODULES

**HMS019-L2**  
Standard Lightbox module 19"  
+ dye-sub graphic

Purchase                    \$ **1,576**

Rental\*                     \$ **581**

GRAPHICS

-----  
Dye-sub graphic only    \$ **155**

**HMS038-L2**  
Standard Lightbox module 38"  
+ dye-sub graphic

Purchase                    \$ **1,991**

Rental\*                     \$ **807**

-----  
Dye-sub graphic only    \$ **300**

\* Rental price includes custom-printed graphics.

Lightbox ships with standard connectors.  
Power supply bracket not included.

# 30 Shelving modules

Display

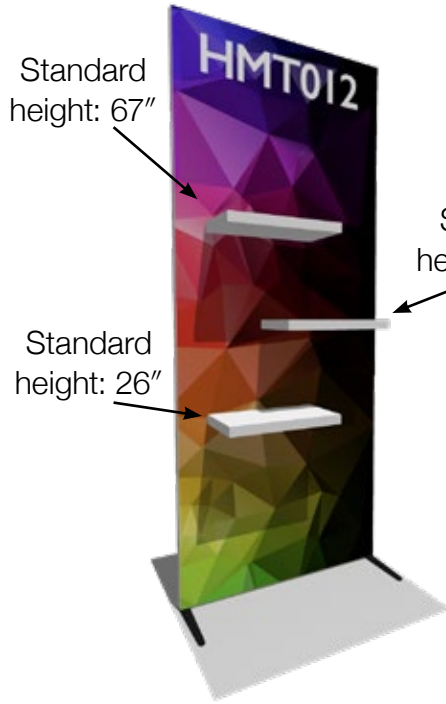

MODULES	<b>HMT011</b>	
	3-shelf module M + dye-sub graphic + 2 feet	
	Purchase	\$ <b>1,282</b>
	Rental*	\$ <b>598</b>
GRAPHICS	-----	
	Dye-sub graphic only	\$ <b>305</b>

<b>HMT012</b>	
3-shelf module M + dye-sub graphic + 2 feet	
Purchase	\$ <b>1,282</b>
Rental*	\$ <b>598</b>
-----	
Dye-sub graphic only	\$ <b>305</b>

<b>HMT013</b>	
3-shelf module M + dye-sub graphic + 2 feet	
Purchase	\$ <b>1,222</b>
Rental*	\$ <b>580</b>
-----	
Dye-sub graphic only	\$ <b>305</b>

<b>HMT014</b>	
3-shelf module M + dye-sub graphic + 2 feet	
Purchase	\$ <b>1,222</b>
Rental*	\$ <b>580</b>
-----	
Dye-sub graphic only	\$ <b>305</b>

\* Rental price includes custom-printed graphics. / The price difference is due to the use of 2 or 3 accessory bars.

# 31 Shelving modules

Display

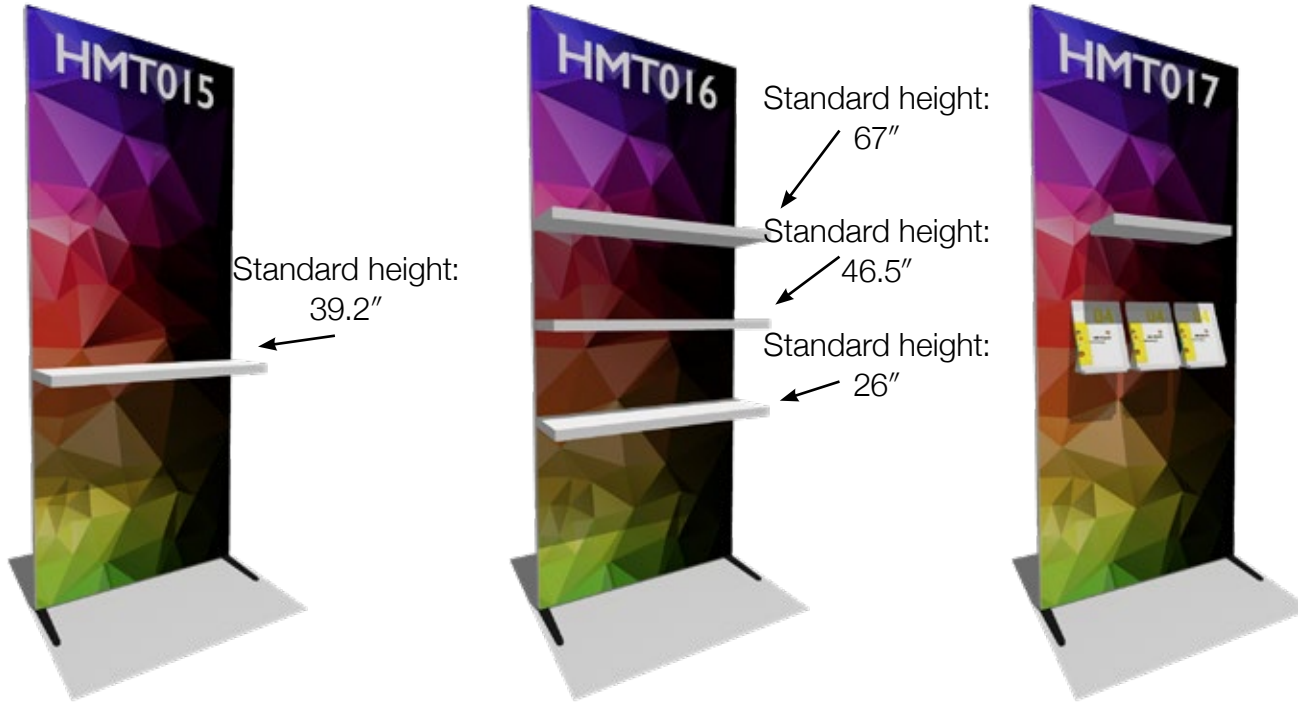

WHITE SHELVES:

Max load: 22 lbs

Dimensions:

L 18.9" x 10.25"

L 37.8" x 10.25"

L 20.4" x 10.25"

Thickness: 1.5"

Standard height of shelves from floor:

26" - 39.2" - 46.5" - 53.8" - 67"

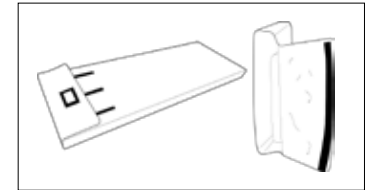

New protective shelf covers included

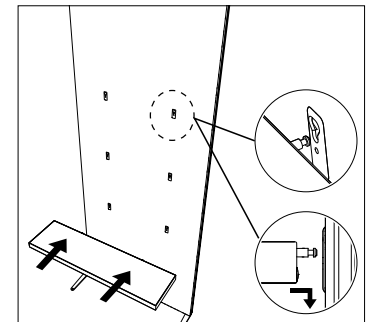

Attaches easily thanks to the universal attachment piece

MODULES

**HMT015**  
1-shelf module L  
+ dye-sub graphic + 2 feet

Purchase \$ **1,040**

Rental\* \$ **526**

GRAPHICS

Dye-sub graphic only \$ **305**

**HMT016**  
3-shelf module L  
+ dye-sub graphic + 2 feet

Purchase \$ **1,317**

Rental\* \$ **609**

Dye-sub graphic only \$ **305**

**HMT017**  
1-shelf module 520 + 3 brochure holders  
+ dye-sub graphic + 2 feet

Purchase \$ **1,349**

Rental\* \$ **608**

Dye-sub graphic only \$ **305**

\* Rental price includes custom-printed graphics.

# 32 Multimedia modules

Spread your message

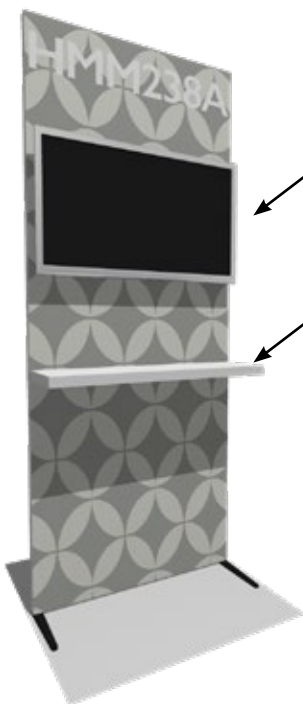

40" TV

Height:  
39.2"



Brochure holder



MODULES

## HMM138A

TV\* Monitor Module 38"  
+ dye-sub graphic + 2 feet

Purchase \$ **1,036**

Rental\*\* \$ **524**

GRAPHICS

Dye-sub graphic only \$ **305**

## HMM238A

TV\* Monitor Module 38"  
+ dye-sub graphic + 1 L shelf + 2 feet

Purchase \$ **1,175**

Rental\*\* \$ **566**

Dye-sub graphic only \$ **305**

## HMM638

TV\* Monitor Module + 3 brochure holders  
+ dye-sub graphic + 1 L shelf + 2 feet

Purchase \$ **1,372**

Rental\*\* \$ **625**

Dye-sub graphic only \$ **305**

\*\* Rental price includes custom-printed graphics.

\*VESA monitor mount (200 x 200 / 400 x 400) with anti-theft security included in price. Recommended TV screen size: 40".  
Weight: 33 lb max. Depth: 3.9" max. Optional TV not included in price.



# 33 Accessory modules

Create your own accessory module

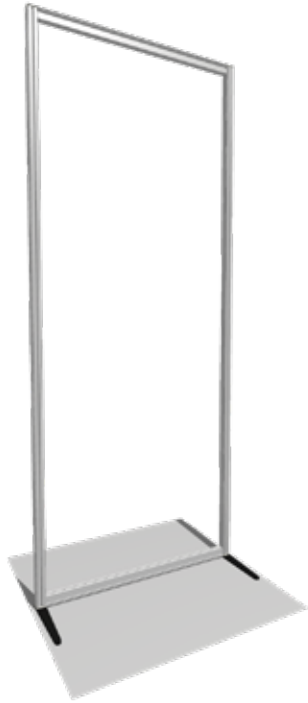

MODULES

**HCS038**  
38" Standard frame

Purchase \$ **360**

**HMF002**  
Vertical accessory bar

Purchase \$ **60**

**CON032**  
Universal accessory attachment piece

Purchase \$ **11**

**ACS010-01**  
Universal attachment hook

Purchase \$ **16**

**ACS018-01** white  
**ACS019-01** black  
Gridwall and connectors

Purchase \$ **175**

**COF086**  
Gridwall support connector

Purchase \$ **15**

GRAPHICS

Dye-sub graphic 38" x 93"

Purchase \$ **305**

For each module, you will need 1 frame + the necessary amount of vertical accessory bars + 2 feet

Number of bars	1	2	3	2	2
Recommended for	Brochure holder	TV	Shelves	Wallframe	Gridwall

# 34 Accessory modules

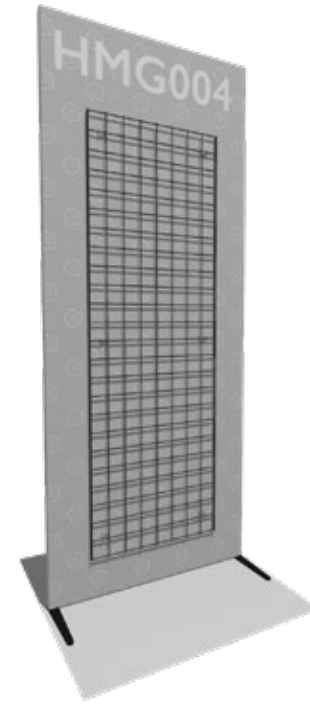
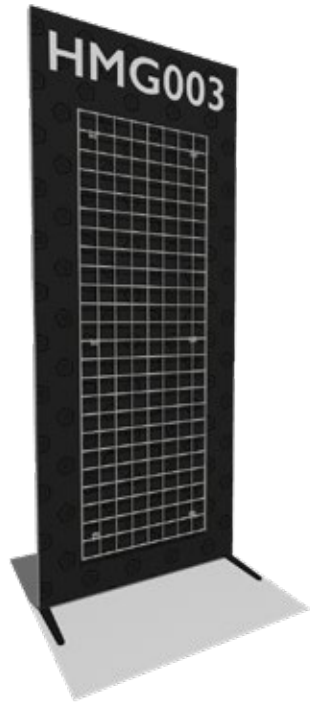

Gridwall size  
2'x6'  
Maximum weight  
33 lbs

MODULES	<b>HMG003</b>	
	White accessory gridwall 38" module + dye-sub graphic + 2 feet	
	Purchase	<b>\$ 1,076</b>
	Rental**	<b>\$ 536</b>
GRAPHICS	-----	
	Dye-dub graphic	<b>\$ 305</b>

	<b>HMG004</b>	
	Black accessory gridwall 38" module + dye-sub graphic + 2 feet	
	Purchase	<b>\$ 1,076</b>
	Rental**	<b>\$ 536</b>
	-----	
	Dye-dub graphic	<b>\$ 305</b>

\*\* Rental price includes custom-printed graphics.

# 35 Accessory modules

Create your own accessory module



ACD017 black  
ACD026 white  
2" straight faceout accessory bar  
Purchase \$ **11**



ACD022 black  
ACD031 white  
6" hook accessory  
Purchase \$ **11**



ACD018 black  
ACD027 white  
4", 7 ball waterfall accessory bar  
Purchase \$ **11**



ACD023 black  
ACD032 white  
8" hook accessory  
Purchase \$ **11**



ACD019 black  
ACD028 white  
6", 5 hooks waterfall accessory bar  
Purchase \$ **11**



ACD024 black  
ACD033 white  
10" hook accessory  
Purchase \$ **11**



ACD020 black  
ACD029 white  
2" hook accessory  
Purchase \$ **11**



ACD025 black  
ACD034 white  
12" hook accessory  
Purchase \$ **11**



ACD021 black  
ACD030 white  
4" hook accessory  
Purchase \$ **11**

## GRIDWALL ACCESSORIES

# 36 Accessory modules



MODULES

## HMF038-01

3 brochure holders module  
+ dye-sub graphic + 2 feet

Purchase \$ **1,117**

Rental\*\* \$ **549**

GRAPHICS

-----  
Dye-sub graphic \$ **305**

## HMF038-02

2 brochure holders module  
+ dye-sub graphic + 2 feet

Purchase \$ **1,085**

Rental\*\* \$ **539**

-----  
Dye-sub graphic \$ **305**

## HMF138

Wallframe contour 34" x 19" module  
+ dye-sub graphic + 2 feet

Purchase \$ **1,123**

Rental\*\* \$ **599**

-----  
Dye-sub graphic \$ **305**

\*\* Rental price includes custom-printed graphics.

# 37 Canopy modules

Create your own arch module

Choose the front of the arch from among the modules in the brochure (excluding doors), then select the top from among the canopy modules located below.

Design



MODULES

**HMV219A**  
Canopy module 19"x85"  
+ dye-sub graphic

Purchase \$ **540**

Rental\* \$ **264**

GRAPHICS

Dye-sub graphic \$ **145**

**HMV238A**  
Canopy module 38"x85"  
+ dye-sub graphic

Purchase \$ **720**

Rental\* \$ **416**

Dye-sub graphic \$ **285**

**HMV438**  
Canopy module with 3 LED lights 38"x85"  
+ dye-sub graphic

Purchase \$ **1,074**

Rental\* \$ **522**

Dye-sub graphic \$ **285**

**LLD022-01**  
3 LED spotlight kit for 38"x85.5"  
canopy (3 spotlights + 3 panels)\*\*

Purchase \$ **242**

\*\* Rental price includes custom-printed graphics. \*\*60W electricity supply (LLA061) not included.

# 38 Lightbox canopy modules Create your own arch module

Choose the front of the arch from among the modules in the brochure (excluding doors), then select the top from among the canopy modules located below.

Design

3.15" thick



1.57" thick



MODULES

**HMV238-L**  
Canopy lightbox module 38"x85"  
+ dye-sub graphic

Purchase            **\$ 2,110**  
Rental\*            **\$ 833**

GRAPHICS

-----  
Dye-sub graphic    **\$ 285**

**HMV219-L2**  
Canopy module 19"x85"  
+ dye-sub graphic

Purchase            **\$ 1,615**  
Rental\*            **\$ 586**

-----  
Dye-sub graphic    **\$ 145**

**HMV238-L2**  
Canopy lightbox module 38"x85"  
+ dye-sub graphic

Purchase            **\$ 2,020**  
Rental\*            **\$ 806**

-----  
Dye-sub graphic    **\$ 285**

\*Rental price includes custom-printed graphics.

# 39 Arch modules

Design

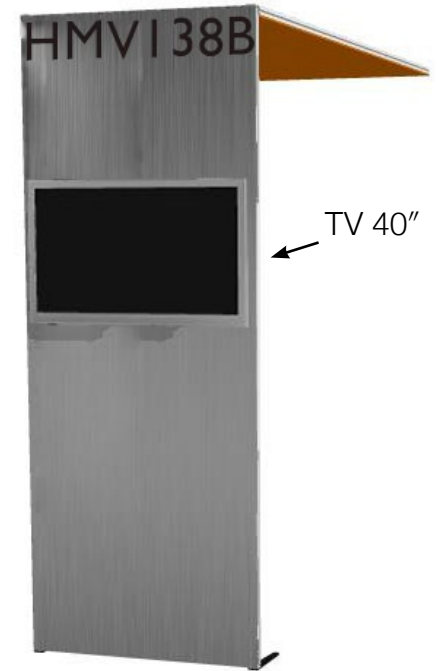
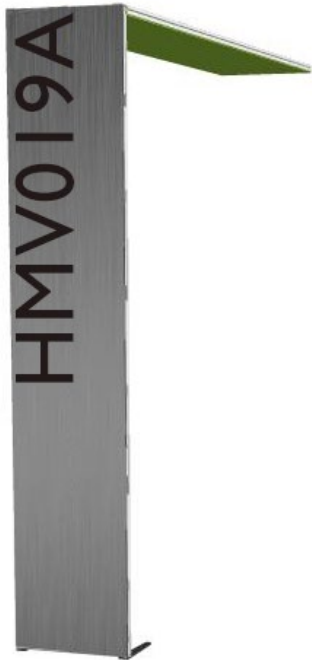

MODULES

**HMV019A**  
Arch module 19"  
+ dye-sub graphics  
+ 2 feet

Purchase \$ **1,335**

Rental\* \$ **719**

GRAPHICS

-----  
Dye-sub graphics only \$ **455**

**HMV038A**  
Arch module 38"  
+ dye-sub graphics  
+ 2 feet

Purchase \$ **1,860**

Rental\* \$ **1,178**

-----  
Dye-sub graphics only \$ **885**

**HMV138B**  
Arch module 38" + 40" TV\*\*  
+ dye-sub graphics  
+ 2 feet

Purchase \$ **2,120**

Rental\* \$ **1,259**

-----  
Dye-sub graphics only \$ **890**

\*Rental price includes custom-printed graphics.

\*\*VESA monitor mount (200 x 200 / 400 x 400) with anti-theft security included in price. Recommended TV screen size: 40". Weight: 33 lb max. Depth: 3.9" max. Optional TV not included in price.

# 40 Lightbox Arch modules – 3.15" thick

Design

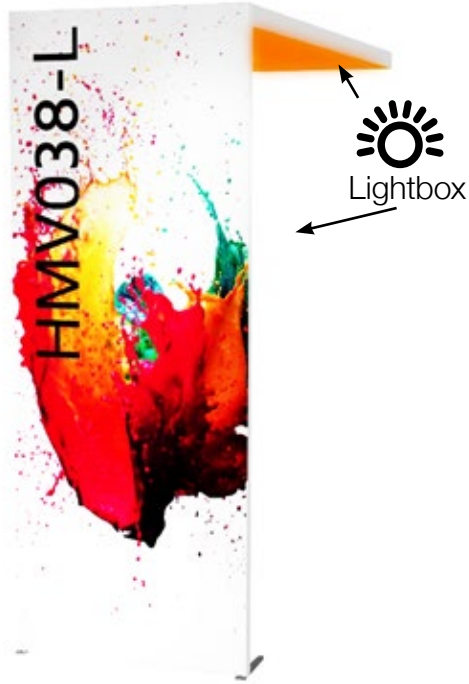

MODULES

**HMV038-L**  
Arch module with front\*\*  
and canopy lightboxes  
+ dye-sub graphics + 2 feet

Purchase \$ **4,643**

Rental\* \$ **2,012**

GRAPHICS

-----  
Dye-sub graphics only \$ **885**

**HMV438-L**  
Arch module with canopy lightbox  
+ dye-sub graphics  
+ 2 feet

Purchase \$ **3,250**

Rental\* \$ **1,595**

-----  
Dye-sub graphics only \$ **885**

**HMV538-L**  
Arch module with front lightbox\*\*  
+ dye-sub graphics  
+ 2 feet

Purchase \$ **3,253**

Rental\* \$ **1,596**

-----  
Dye-sub graphics only \$ **885**



# 41 New Lightbox Arch modules - 1.57" thick

Design



MODULES

**HMV038-L2**  
Arch module with front\*\*  
and canopy lightboxes  
+ dye-sub graphics + 2 feet

Purchase \$ **4,460**

Rental\* \$ **1,958**

GRAPHICS

-----  
Dye-sub graphics only \$ **885**

**HMV438-L2**  
Arch module with canopy lightbox  
+ dye-sub graphics  
+ 2 feet

Purchase \$ **3,160**

Rental\* \$ **1,568**

-----  
Dye-sub graphics only \$ **885**

**HMV538-L2**  
Arch module with front lightbox\*\*  
+ dye-sub graphics  
+ 2 feet

Purchase \$ **3,160**

Rental\* \$ **1,568**

-----  
Dye-sub graphics only \$ **885**

\* Rental price includes custom-printed graphics. \*\* Module can be rotated so that the rear side is backlit

Power supply bracket not included.

# 42 Header modules

Be seen

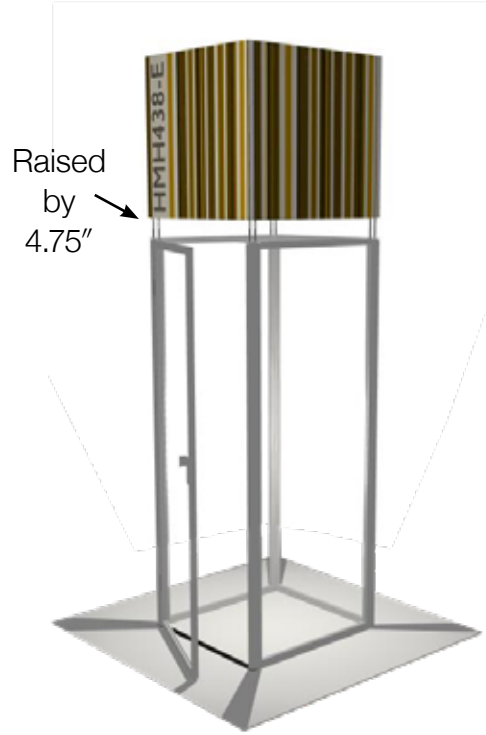

**MODULES**

**HMH438**  
Header module\* 38"x38"  
+ dye-sub graphics

Purchase	\$ <b>1,599</b>
Rental**	\$ <b>839</b>

**HMH438-E**  
Header module\* 38"x38"  
with spacers  
+ dye-sub graphics

Purchase	\$ <b>1,662</b>
Rental**	\$ <b>858</b>

**HMH638**  
Header module\* 38"x76"  
+ dye-sub graphics

Purchase	\$ <b>2,386</b>
Rental**	\$ <b>1,255</b>

**HMH638-E**  
Header module\* 38"x76"  
with spacers  
+ dye-sub graphics

Purchase	\$ <b>2,491</b>
Rental**	\$ <b>1,286</b>

**GRAPHICS**

Dye-sub graphics only	\$ <b>513</b>
<b>Total height</b>	131"

Dye-sub graphics only	\$ <b>513</b>
<b>Total height</b>	136"

Dye-sub graphics only	\$ <b>770</b>
<b>Total height</b>	131"

Dye-sub graphics only	\$ <b>770</b>
<b>Total height</b>	136"

Storage modules are required for these options

\*Only for 38" x 38" and 38" x 76" storage modules

\*\* Rental price includes custom-printed graphics.

# 43 Signage modules

Be seen

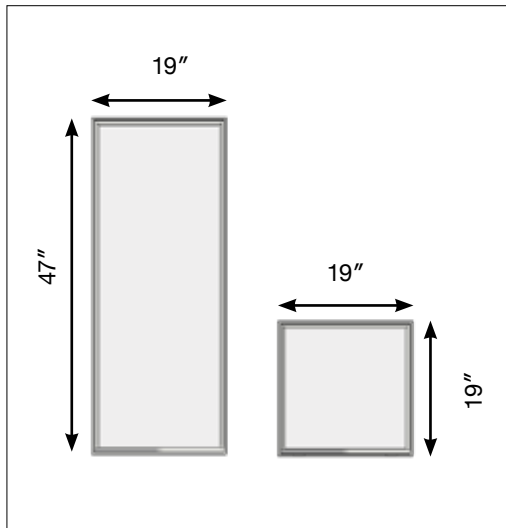
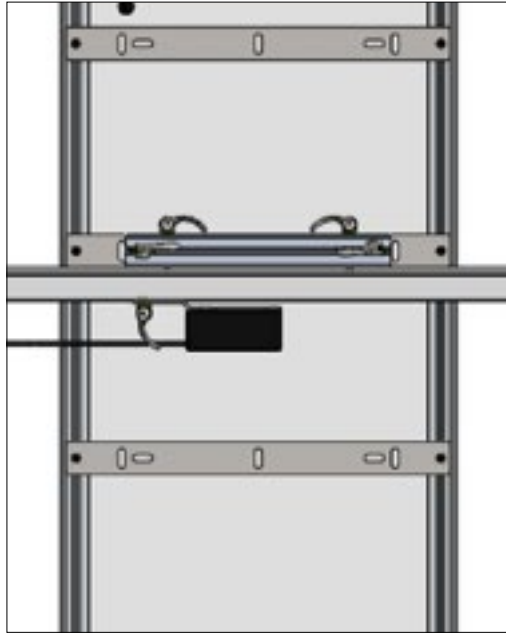

- Think outside the frame!
- 2 dimensions: 19" x 19" or 19" x 47"
- 3 pre-defined positions: low, middle, high
- Lightbox or non-lightbox
- Ships pre-assembled in the top case

# 44 Signage modules

Be seen

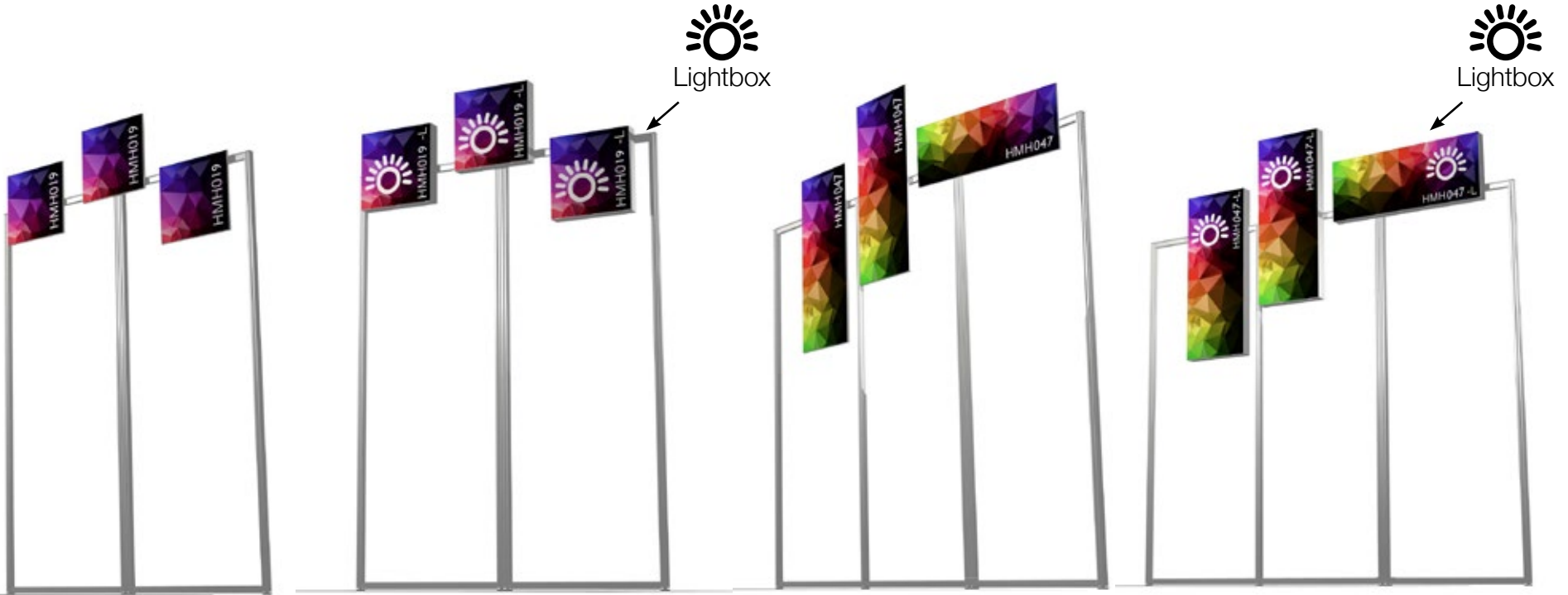

MODULES	HMH019 Signage module S + dye-sub graphic	
	Purchase	<b>\$ 285</b>
	Rental*	<b>\$ 124</b>

GRAPHICS	Dye-sub graphic only	<b>\$ 55</b>
	Graphic dimensions 19"x19"	

HMH019-L Lightbox signage module S + dye-sub graphic	
Purchase	<b>\$ 705</b>
Rental*	<b>\$ 250</b>

Dye-sub graphic only	<b>\$ 55</b>
Graphic dimensions 19"x19"	

HMH047 Signage module M + dye-sub graphic	
Purchase	<b>\$ 355</b>
Rental*	<b>\$ 166</b>

Dye-sub graphic only	<b>\$ 75</b>
Graphic dimensions 19"x47"	

HMH047-L Lightbox signage module M + dye-sub graphic	
Purchase	<b>\$ 905</b>
Rental*	<b>\$ 324</b>

Dye-sub graphic only	<b>\$ 75</b>
Graphic dimensions 19"x47"	

\*Rental price includes custom-printed graphics.

# 45 USB counters and consoles

Greet



- New USB hub option
- Integrates directly into the countertop
- Equipped with 4 USB ports and a hole to feed through other cables
- Available as an add-on on counter and console modules

# 46 Counter modules

Greet

Total height (countertop included) : 39.5"

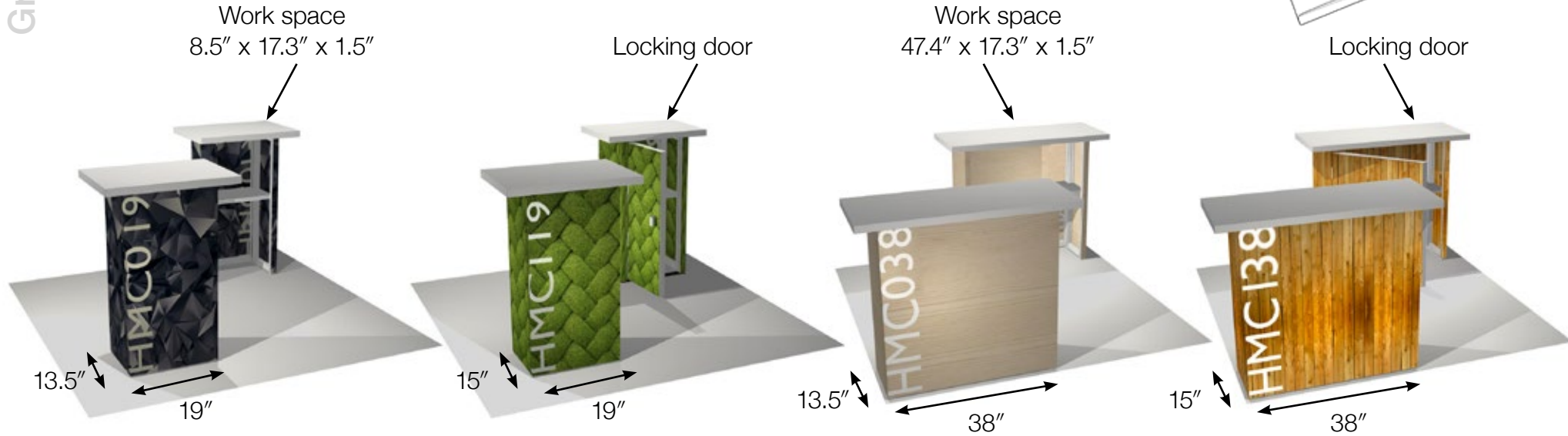

MODULES

### HMC019

Small counter module  
(28.5" x 17.3" x 39.5")  
+ dye-sub graphics

Purchase \$ **958**

Rental\* \$ **426**

GRAPHICS

Dye-sub graphics only \$ **160**

HMC019-USB   
Option with USB hub

Purchase \$ **1,068**

Rental\* \$ **432**

### HMC119

Small counter module with door  
(28.5" x 17.3" x 39.5")  
+ dye-sub graphics

Purchase \$ **1,340**

Rental\* \$ **574**

Dye-sub graphics only \$ **245**

HMC119-USB   
Option with USB hub

Purchase \$ **1,450**

Rental\* \$ **607**

### HMC038

Medium counter module  
(47.4" x 17.3" x 39.5")  
+ dye-sub graphics

Purchase \$ **1,216**

Rental\* \$ **518**

Dye-sub graphics only \$ **218**

HMC038-USB   
Option with USB hub

Purchase \$ **1,326**

Rental\* \$ **551**

### HMC138

Medium counter module  
(47.4" x 17.3" x 39.5")  
+ dye-sub graphics

Purchase \$ **1,688**

Rental\* \$ **761**

Dye-sub graphics only \$ **363**

HMC138-USB   
Option with USB hub

Purchase \$ **1,798**

Rental\* \$ **794**

\*Rental price includes custom-printed graphics.



# 47 Lightbox counter modules 3.15" thick

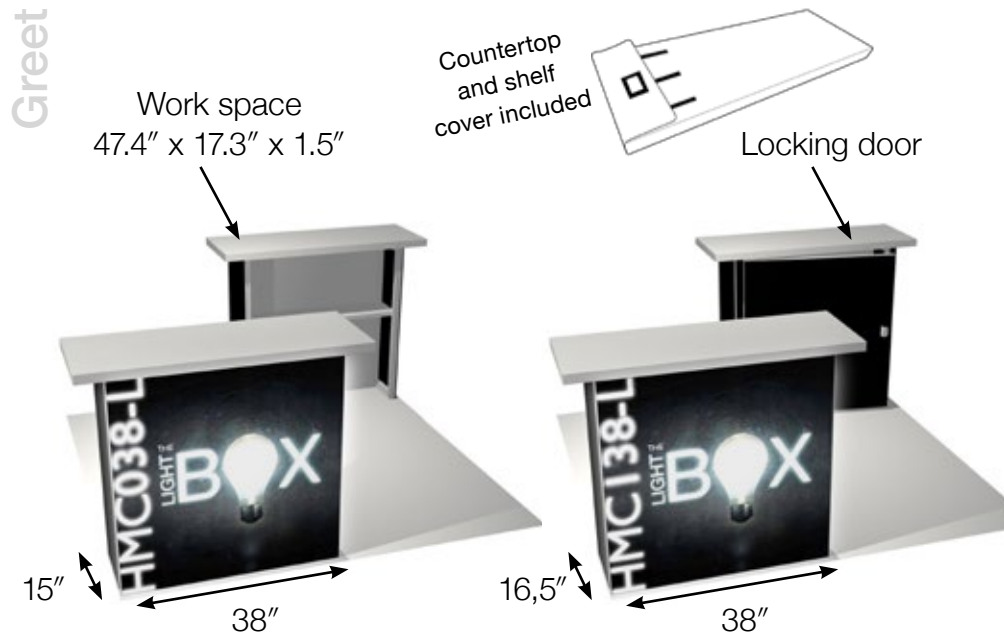

# New: 1.57" thick

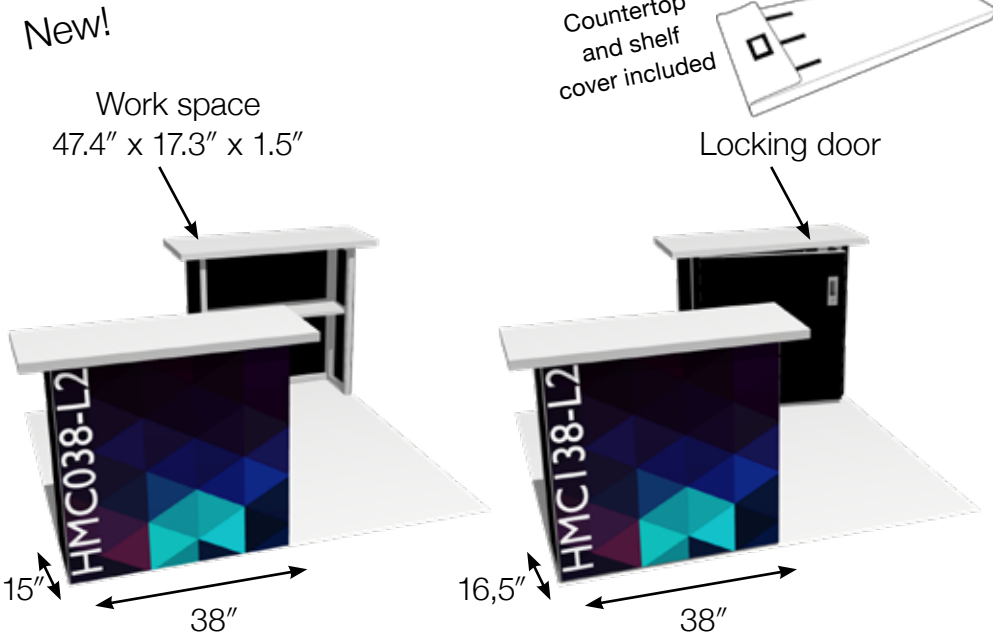

MODULES	HMC038-L	M Counter module with front lightbox ( 47.7" x 19.3" x 39.5") + dye-sub graphics
	Purchase	\$ <b>1,983</b>
	Rental*	\$ <b>745</b>
GRAPHICS	Dye-sub graphics only	\$ <b>215</b>
	HMC038-L2-USB	Option with USB hub
	Purchase	\$ <b>2,093</b>
	Rental*	\$ <b>778</b>

HMC138-L	M counter module with door and front lightbox ( 47.7" x 19.3" x 39.5") + dye-sub graphics
Purchase	\$ <b>2,455</b>
Rental*	\$ <b>989</b>
Dye-sub graphics only	\$ <b>360</b>
HMC138-L2-USB	Option with USB hub
Purchase	\$ <b>2,565</b>
Rental*	\$ <b>1,022</b>

HMC038-L2	M Counter module with front lightbox ( 47.7" x 19.3" x 39.5") + dye-sub graphics
Purchase	\$ <b>1,948</b>
Rental*	\$ <b>735</b>
Dye-sub graphics only	\$ <b>215</b>
HMC038-L2-USB	Option with USB hub
Purchase	\$ <b>2,058</b>
Rental*	\$ <b>768</b>

HMC138-L2	M counter module with door and front lightbox ( 47.7" x 19.3" x 39.5") + dye-sub graphics
Purchase	\$ <b>2,420</b>
Rental*	\$ <b>978</b>
Dye-sub graphics only	\$ <b>360</b>
HMC138-L2-USB	Option with USB hub
Purchase	\$ <b>2,530</b>
Rental*	\$ <b>1,011</b>

\*Rental price includes custom-printed graphics.

# 48 Connecting modules

Connect two HMC038  
counters to create  
a 94.5" x 17.3" work space



Additional  
work space  
17.3" x 17.3"



MODULES  
GRAPHICS

## HMC003

Connecting module to connect  
2 counters (straight)  
+ dye-sub graphic

Purchase \$ **247**

Rental\* \$ **120**

-----  
Dye-sub graphics only \$ **65**

## HMC004

Connecting module to connect  
2 counters (angle)  
+ dye-sub graphics

Purchase \$ **706**

Rental\* \$ **327**

-----  
Dye-sub graphics only \$ **165**

\*Rental price includes custom-printed graphics.

\*\*The HMC004 module is not compatible with the lightbox counters.  
Power supply bracket not included.



# 49 Console modules

Console height (incl. countertop): 39.2"

Negotiate

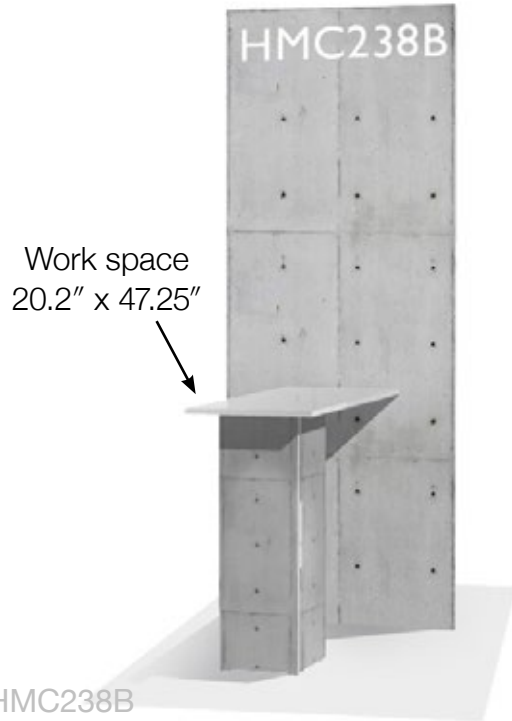

Work space  
20.2" x 47.25"

MODULES

**HMC238B**  
Console module  
+ dye-sub graphics

Purchase            **\$ 1,776**  
Rental\*             **\$ 841**

GRAPHICS

Dye-sub graphics only   **\$ 440**

**HMC238B-USB**   
Option with USB hub

Purchase            **\$ 1,886**  
Rental\*             **\$ 874**

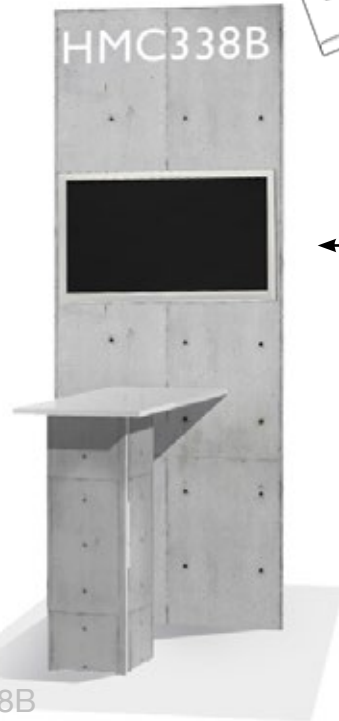

Countertop cover included

**HMC338B**

40" TV

**HMC338B**  
Console module with 40" TV\*\*  
+ dye-sub graphics

Purchase            **\$ 1,911**  
Rental\*             **\$ 881**

Dye-sub graphics only   **\$ 440**

**HMC338B-USB**   
Option with USB hub

Purchase            **\$ 2,021**  
Rental\*             **\$ 914**



1 graphic

shelf

3 graphics



Grommet for cable  
management

\*Rental price includes custom-printed graphics.

\*\*VESA monitor mount (200 x 200 / 400 x 400) with anti-theft security included in price. Recommended TV screen size: 40". Weight: 33 lb max. Depth: 3.9" max. Optional TV not included in price.

Accessory module  
compatible

# 50 Pre-fit your modules!

Accessoirize

TV40L (-LOC)  
TV Samsung LED 3D 40"  
+ remote control

Purchase \$ **1,150**

Rental \$ **345**



ACS011-01  
TV mount

Purchase \$ **135**



ACS012-01  
Tablette holder

Purchase \$ **108**



COF071-01  
Brochure holder

Purchase \$ **81**



ACT028-12  
18.9" x 10.25" S shelf  
+ 2 supports + cover

Purchase \$ **81**



ACT028-13  
20.4" x 10.25" M shelf  
+ 2 supports + cover

Purchase \$ **85**



ACT028-11  
37.8" x 10.25" L shelf  
+ 2 supports + cover

Purchase \$ **115**



HCW001  
wall.frame 34"x19"

Purchase \$ **130**



# 51 Pre-fit your modules!

Accessorize

COL037  
h-line connector

Purchase \$ **13**



COL032-01  
Lightbox connector

Purchase \$ **35**



COF065-01  
Power supply bracket for lightbox

Purchase \$ **33**



HAL002  
Electricity kit (two 10' extension cords + one 3-outlet power strip)

Purchase \$ **80**



HAL004  
Electricity kit with attachment piece (two 3m extension cords + one 3-outlet power strip + attachment piece for power supply)

Purchase \$ **90**



LED4-US-S3  
LED light with bag

Purchase \$ **135**

Rental \$ **41**



LLF020  
Transformer + 6 extension cords

Purchase \$ **250**



# 52 Pre-fit your modules!

Accessoirize

New!

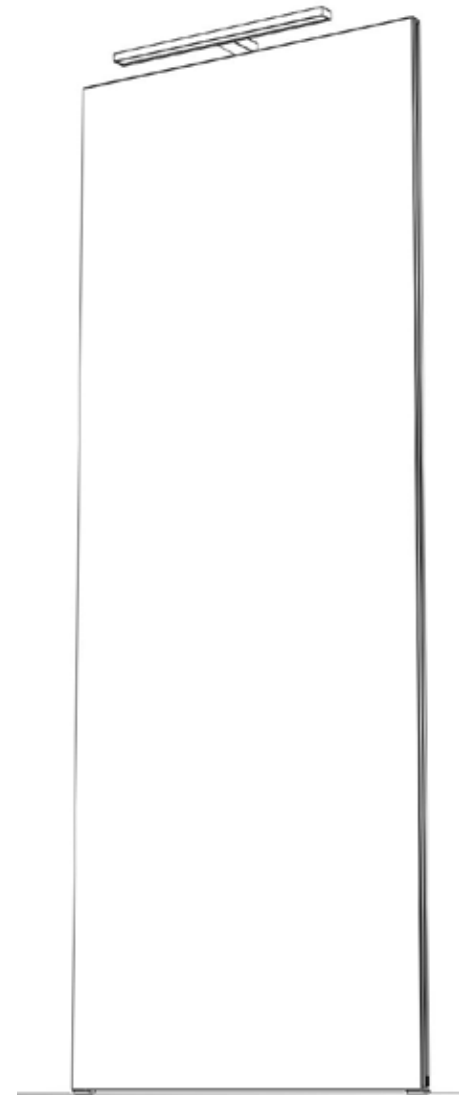
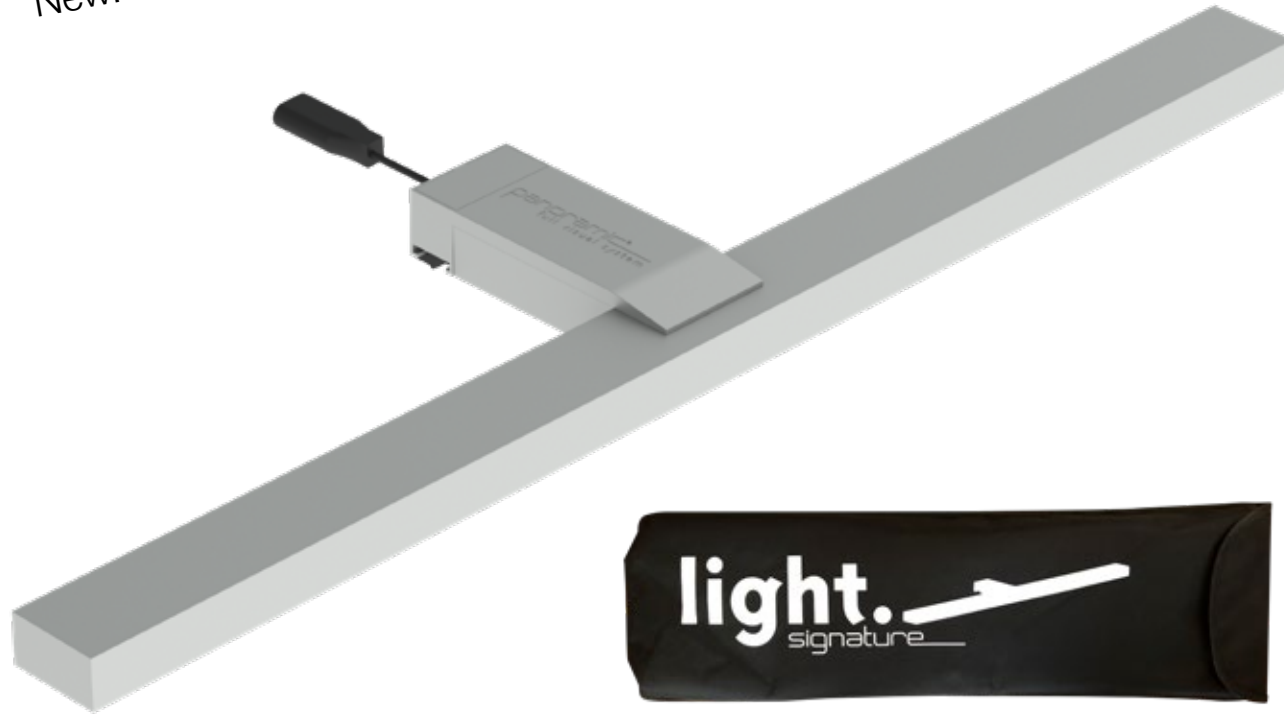

**LED-SIGNATURE-US**  
Signature LED 20W spotlight with transformer and bag

Purchase     \$ **250**

Rental        \$ **75**

With its sleek, contemporary lines, it integrates flawlessly into your booth designs.

It lights the panel powerfully and uniformly thanks to its elongated 23.62" form, as well as its specially designed optics.

# 53 Pre-fit your modules!

Accessoirize

ACP022  
Stabilizing foot

Purchase \$ **45**



ACP023  
Double-sided stabilizing foot

Purchase \$ **100**



ALP005-04  
Aluminum profile cover (height 93")

Purchase \$ **45**



ALP005-07  
Aluminum profile cover (height 46.5")

Purchase \$ **21**



LLS012  
Cord protector

Purchase \$ **60**



HAR001

Storage kit for 38" storage modules (free-standing shelves, coat rack + 4 hangers and 2 trash bins)

Purchase \$ **200**



HAR002

Closet kit for 19" closet modules (rod and 4 hangers + 1 trash bin)

Purchase \$ **120**



# 54 Travel solution

Storage crate

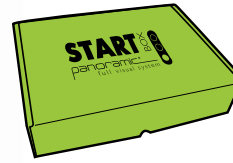

## H3 Crate

Purchase \$ **1,165**

Rental \$ **350**

External dimensions:

L 34" x P 97" x H 60"









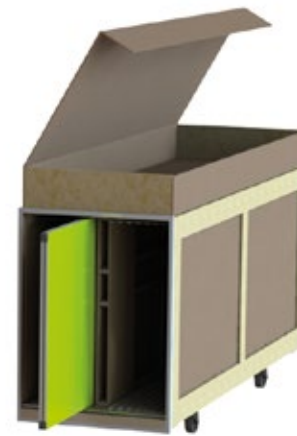







Weight:

370 lbs

Can contain (14) 38" frames, (1) 19" frame and (1) 9.5" frame. For use with liftgate or ramp. Includes a top case.

Track system



CONNECTOR			
ACCESSORIES			
			
			
			
			
STORAGE FURNISHINGS			

# 55 Travel solution

Storage crate



## H5 Crate

Purchase \$ **1,075**

Rental \$ **323**

External dimensions:

30.25" x 56.25"H x 96.5"

Weight:

245 lbs

Can contain 12 frames. For use without liftgate or ramp (case to be loaded wheels up in your vehicle to ensure perfect stability during transport) Includes a top case.



Partitionable crate

# 56 Process

Design and quote your exhibit in 4 easy steps and 30 minutes or less!

3D Studio

Welcome to the panoramic<sup>®</sup>  
h-line

Creating an exhibit has never been so simple

**STEP 01** **EXHIBIT SIZE**  
To start, choose the size and type of booth that you have rented: length, width, and number of open sides.

**MODULE CHOICE**  
At a show, every sq ft counts!  
Welcome, display, store, spread your message...  
Choose and position modules according to the functionalities you need.

**STEP 03** **GRAPHIC WRAPPING**  
The most important thing at a show is to create a strong impact.  
Upload your own creations or be inspired by our selection of colors, patterns, and material effects. Creativity has no limits!

**FURNITURE/FINISHING**  
The success of your exhibit is in the details!  
To finish of the look, we offer a line of furniture, lighting options and additional finishing touches.

**STEP 02**

**STEP 04**

**RENDERING**

**ESTIMATE**

**STEP 01** **BOOTH SIZE**

I DEFINE MY SPACE

I set the characteristics of the space: length, width, number of open sides.

[WWW](#) [Let's go!](#)

**MODULE CHOICE** **STEP 02**

I STRUCTURE MY SPACE

I build my booth by choosing the modules that meet my needs: tables, images, store fronts, spread my message, for your display products, welcome clients. All modules connect to one another.

[WWW](#) [Let's go!](#)

**STEP 03** **GRAPHIC WRAPPING**

I SELECT MY GRAPHICS

I bring my brand: I choose between my own personalized graphics and a database of color, colors, patterns, or material effects. Right click and then click on the predefined graphics to wrap each booth element.

[WWW](#) [Let's go!](#)

**FINISHINGS / FURNITURE** **STEP 04**

I FINALIZE MY BOOTH

The booth is almost complete. The environmental lighting, wall lighting, bar on each end of the booth and more are added.

To add extra items: functionality to your booth, additional chairs and signs are available to order.

A database of accessories, furniture, and gives the rendering complete with cost for each available to you.

[WWW](#) [Let's go!](#) [Let's go!](#) [Let's go!](#)



# 57 Exhibit database

# Even more exhibits at: panoramic-design.com

Find your exhibit in just a few clicks



panoramic<sup>®</sup> full visual system

“panoramic design search”

SEARCH (28 products)

Remove filters

Categories

- 10'x10' (5)
- 10'x20' (18)
- 10'x30' (3)
- 20'x20' (2)
- counters (0)
- modules (0)
- > 20'x20' (0)

Booth Layout

- Corner (2)
- Counter (0)
- Inline (13)
- Island (11)
- Kiosk (2)
- Peninsula (0)

Price

5019 - \$ 18382

Reset this group

- Storage (24)
- Tower / Header / High signage (0)
- Shelves / Column (12)
- Semi private conf. area (16)
- Counter (4)
- Reception / Ask for

There are 28 products.

Sort by Product Name: A to Z

<b>101</b>	<b>102</b>	<b>103</b>	<b>104</b>
Length : 20' Width : 10' Booth size : 10'x20'	Length : 20' Width : 10' Booth size : 10'x20'	Length : 20' Width : 20' Booth size : 20'x20'	Length : 10' Width : 10' Booth size : 10'x10'
<b>\$13,410.00</b>	<b>\$6,887.00</b>	<b>\$17,968.00</b>	<b>\$10,495.00</b>
<a href="#">See the product</a>	<a href="#">See the product</a>	<a href="#">See the product</a>	<a href="#">See the product</a>
<b>106</b>	<b>107</b>	<b>108</b>	<b>109</b>
Length : 20' Width : 10'	Length : 10' Width : 10'	Length : 20' Width : 20'	Length : 20' Width : 10'

# panoramic<sup>®</sup>

h-line

