

# WaterVue Smart Bathroom TV User Manual



  
WaterVue

Models: 19", 24", 27", 32", 43"

# Content

|                               |    |
|-------------------------------|----|
| <b>Safety Information</b>     | 3  |
| <b>TV Specifications</b>      | 4  |
| <b>Accessories</b>            | 8  |
| <b>Overview of Back Panel</b> | 9  |
| <b>Remote Control Unit</b>    | 10 |
| <b>Home Page</b>              | 12 |
| What's New                    | 12 |
| Featured APP                  | 12 |
| Apps                          | 14 |
| Sports & Music                | 15 |
| Settings                      | 15 |
| Media Player                  | 23 |
| <b>TV Apps</b>                | 28 |
| Input Source                  | 28 |
| Main Menu                     | 29 |
| <b>Troubleshooting</b>        | 39 |

# Safety Information

## IMPORTANT SAFETY INSTRUCTIONS

Read these instructions.

Keep these instructions.

Heed all warnings.

Follow all instructions.

Do not use this apparatus near water.

Clean only with dry cloth.

Do not block any ventilation openings. Install in accordance with the manufactures instructions.

Do not install near any heat sources such as radiators, heat registers, stoves, or other apparatus (including amplifiers) that produce heat.

Do not defeat the safety purpose of the polarized or grounding plug. A polarized plug has two blades with one wider than the other. A grounding plug has two blades and a third grounding prong. The wide blade or the third prong is provided for your safety. If the provided plug does not fit into your outlet, consult an electrician for replacement of the obsolete outlet.

Protect the power cord from being walked on or pinched particularly at the plugs, convenience receptacles, and at the point where they exit from the apparatus. Only use attachments/accessories specified by the manufacturer.

Use only with the cart, stand, tripod, bracket, or table specified by the manufacturer, or sold with the apparatus. When a cart or rack is used, use caution when moving the cart/apparatus combination to avoid injury from tip-over.



Unplug the apparatus during lightning storms or when unused for long periods of time.

Refer all servicing to qualified personnel. Servicing is required when the apparatus has been damaged in any way, such as power supply cord or plug is damaged, liquid has been spilled or objects have fallen into the apparatus has been exposed to rain or moisture, does not operate normally, or has been dropped.

**CAUTION:** These servicing instructions are for use by qualified service personnel only. To reduce the risk of electric shock, do not perform any servicing other than that contained in the operating instructions unless you are qualified to do so.

**WARNING:** To reduce the risk of fire or electric shock, do not expose this apparatus to rain or moisture. The apparatus shall not be exposed to dripping or splashing and that objects filled with liquids, such as vases, shall not be placed on apparatus.

**WARNING:** The mains plug is used as disconnect device, the disconnect device shall remain readily operable.



- This lightning flash with arrowhead symbol within an equilateral triangle is intended to alert the user to the presence of non-insulated "dangerous voltage" within the product's enclosure that may be of sufficient magnitude to constitute a risk of electric shock.

- **WARNING:** To reduce the risk of electric shock, do not remove cover (or back) as there are no user-serviceable parts inside. Refer servicing to qualified personnel.

- The exclamation point within an equilateral triangle is intended to alert the user to the presence of important operating and maintenance instructions in the literature accompanying the appliance.

Apparatus with class I construction shall be connected to a mains socket outlet with a protective earthing connection.

# TV Specifications

|                            |   |
|----------------------------|---|
| Screen Size                | 19"   |
| Display Type               | TFT LED   |
| Resolution                 | 1366 x 768  |
| Aspect Ratio               | 16:9  |
| Alimentation               | DC 12V  4A |
| Audio Output               | L/R 5W x 2  |
| Dimensions of Front Screen | 490mm x 335mm x 5mm   |
| Mounting Plate             | 473mm x 318mm x 51 mm   |

|   |   |
|---|---|
| Screen size                               | 24"   |
| Display Type                              | TFT LED   |
| Resolution                                | 1920 x 1080   |
| Aspect Ratio                              | 16:9  |
| Alimentation                              | DC 12V  4A |
| Audio Output                              | L/R 5W x 2  |
| Dimensions of Front Screen Mounting Plate | 594mm x 396mm x 5mm   |
| Mounting Plate                            | 577mm x 379mm x 51 mm   |

## Products Fiche

| Model No | Energy label | Screen mm/inch | On-Mode power consumption (max) | Annual energy consumption | Standby energy consumption |
|----------|--------------|----------------|---------------------------------|---------------------------|----------------------------|
| 19"      | A            | 47/19          | 18W                             | 26KWH                     | 0.5W                       |
| 24"      | A            | 60/24          | 24W                             | 35KWH                     | 0.5W                       |

# TV Specifications

|                            |                      |
|----------------------------|----------------------|
| Screen Size                | 27"                  |
| Display Type               | TFT LED              |
| Resolution                 | 1920 x 1080          |
| Aspect Ratio               | 16:9                 |
| Alimentation               | DC 12V $\equiv$ 6A   |
| Audio Output               | L/R 5W x 2           |
| Dimensions of Front Screen | 658mm x 454mm x 5mm  |
| Mounting Plate             | 642mm x 438mm x 54mm |

|                            |                      |
|----------------------------|----------------------|
| Screen Size                | 32"                  |
| Display Type               | TFT LED              |
| Resolution                 | 1920 x 1080          |
| Aspect Ratio               | 16:9                 |
| Alimentation               | DC 12V $\equiv$ 7A   |
| Audio Output               | L/R 5W x 2           |
| Dimensions of Front Screen | 775mm 508mm x 5mm    |
| Mounting Plate             | 760mm x 492mm x 57mm |

|                            |                        |
|----------------------------|------------------------|
| Screen Size                | 43"                    |
| Display Type               | TFT LED                |
| Resolution                 | 1920 x 1080            |
| Aspect Ratio               | 16:9                   |
| Alimentation               | DC 12V $\equiv$ 7A     |
| Audio Output               | L/R 5W x 2             |
| Dimensions of Front Screen | 1031mm x 661mm x 5mm   |
| Mounting Plate             | 1006mm x 635mm x 61 mm |

## Products Fiche

| Model No | Energy label | Screen mm/inch | On-Mode power consumption (max) | Annual energy consumption | Standby energy consumption |
|----------|--------------|----------------|---------------------------------|---------------------------|----------------------------|
| 27"      | A            | 68.6/27        | 35W                             | 51KWH                     | 0.5W                       |
| 32"      | A            | 81/32          | 35W                             | 51KWH                     | 0.5W                       |
| 43"      | A+           | 109/43         | 52W                             | 76KWH                     | 0.5W                       |

## NOTE

Design and specification modification may be made at any time without prior notice, all data and dimensions are approximations.

# Energy rating

19"

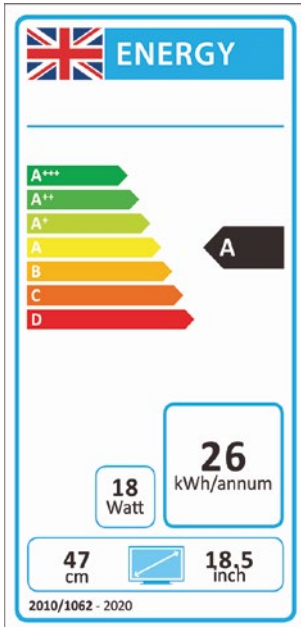

24"

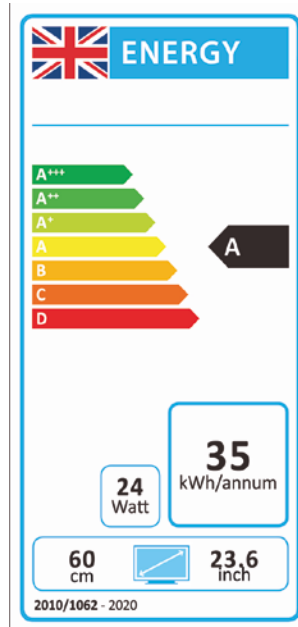

27"

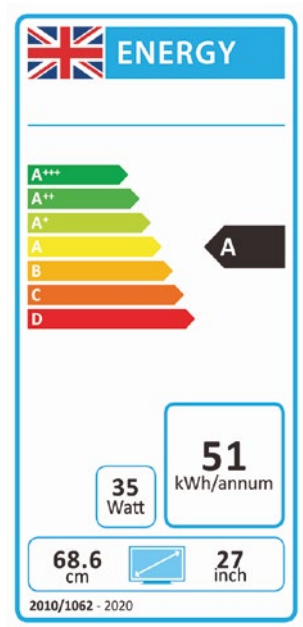

32"

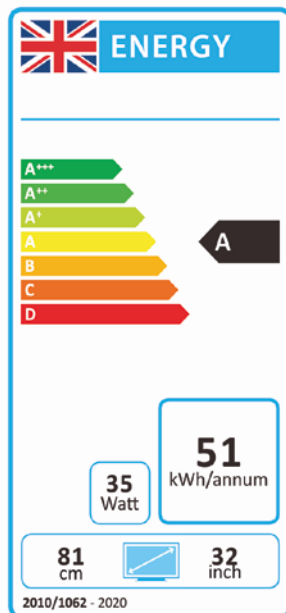

43"

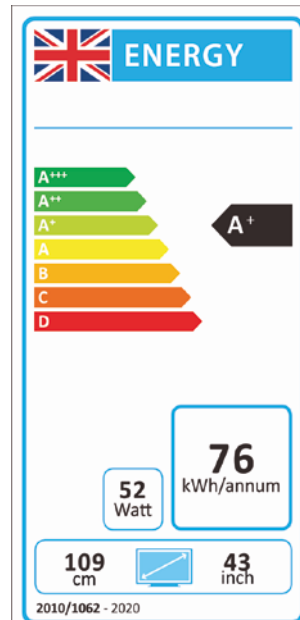

# EU Declaration of Conformity

This product complies with the following standards

EMC Directive: 2014/30/EU

Low voltage directive: 2014/35/EU

RoHS Directive: 2011/65/EC

RE Directive: 2014/53/EU

Relevant harmonized standards user or other technical specifications in relation to which conformity is declared:

|                     |  |
|---------------------|--|
| <b>Safety</b>       | EN 60065:2014  |
| <b>EMC</b>          | EN 55032:2015  |
|                     | EN 61000-3-2:2014  |
|                     | EN 61000-3-3:2013  |
|                     | EN 55035:2017  |
| <b>ROHS</b>         | IEC 62321-4:2013<br>+AMD1:2017<br>IEC 62321-5:2013<br>IEC 62321-6:2015<br>IEC 62321-7-1:2015<br>IEC 62321-7-2:2017<br>IEC 62321-8:2017 |
| <b>RE Directive</b> | EN55032<br>EN301489-17   |

15/04/2021

# Accessories

Please make sure the following items are included with your LED TV. If any items are missing, contact your dealer.

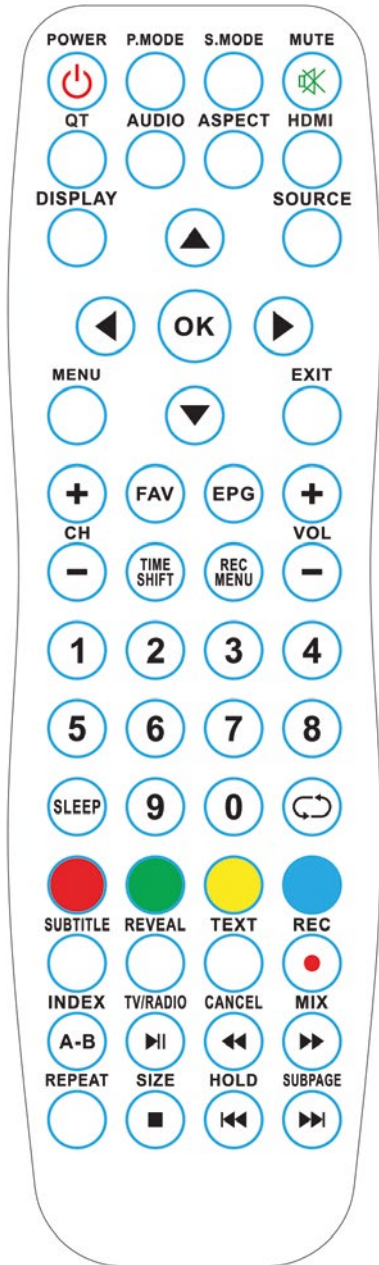

Remote Control



Power Cord



Mains Adaptor

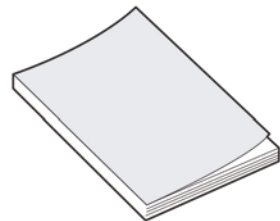

Owner's Instructions



Battery (CR2032)



# Overview of back panel 19"/24"/32"/43"

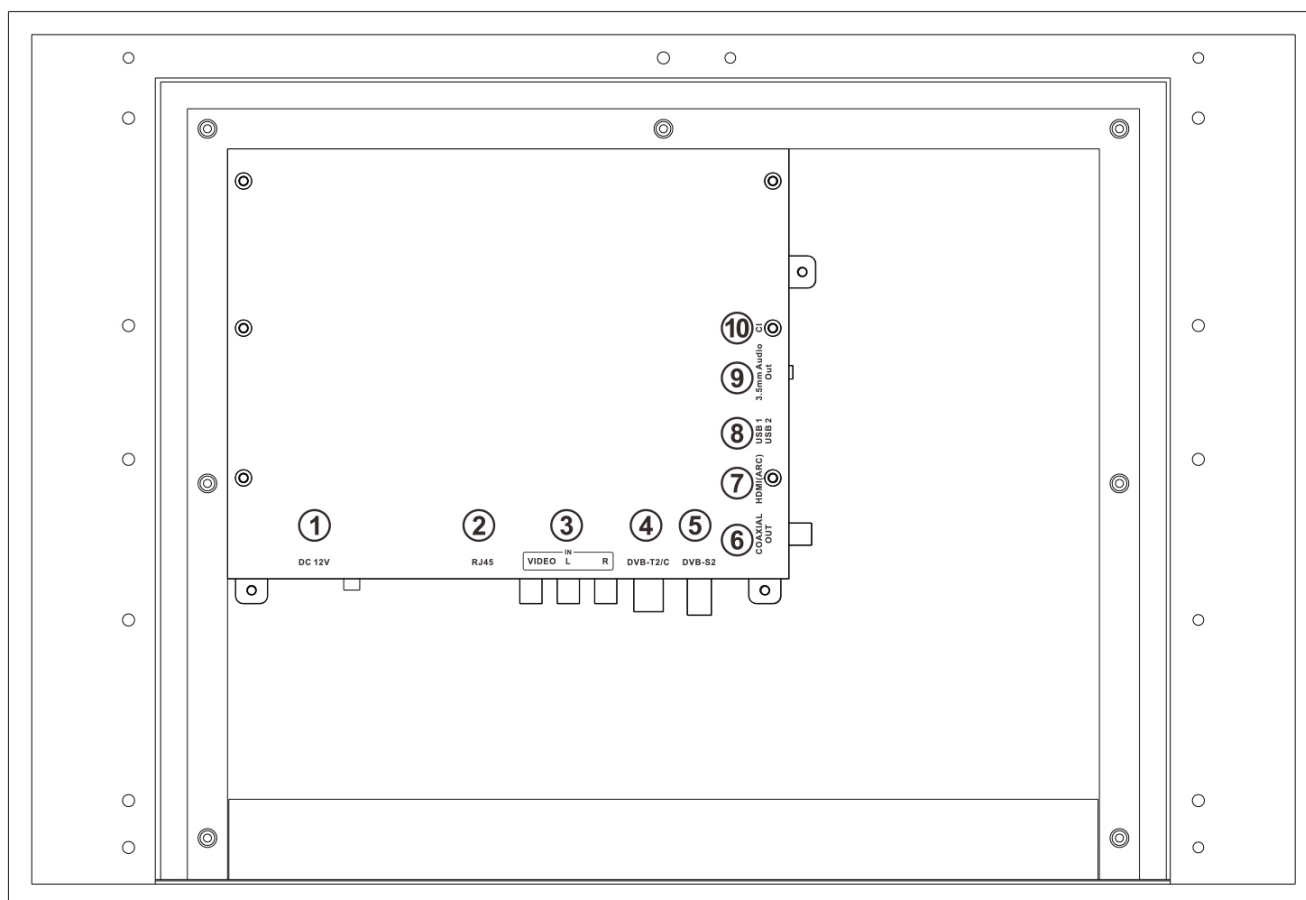

- 1. DC 12V**  
DV 12V input.
- 2. RJ45**  
Ethernet connection.
- 3. VIDEO**  
Connect for VIDEO signal input in Composite mode
- 4. DVB-T2**  
Connected to external antenna to receive the ATV/DTV program in ATV/DTV mode.
- 5. DVB-S2**  
Connected to external SATELLITE to receive.
- 6. COAXIAL OUT**  
Coaxial Digital audio output.
- 7. HDMI (ARC)**  
Connect for HDMI.
- 8. USB 1/2**  
Connect media stick for content.
- 9. 3.5mm Audio Out**  
Connection for external speakers.
- 10. CI SLOT**  
Use to insert the CI card.

# Remote Control Unit

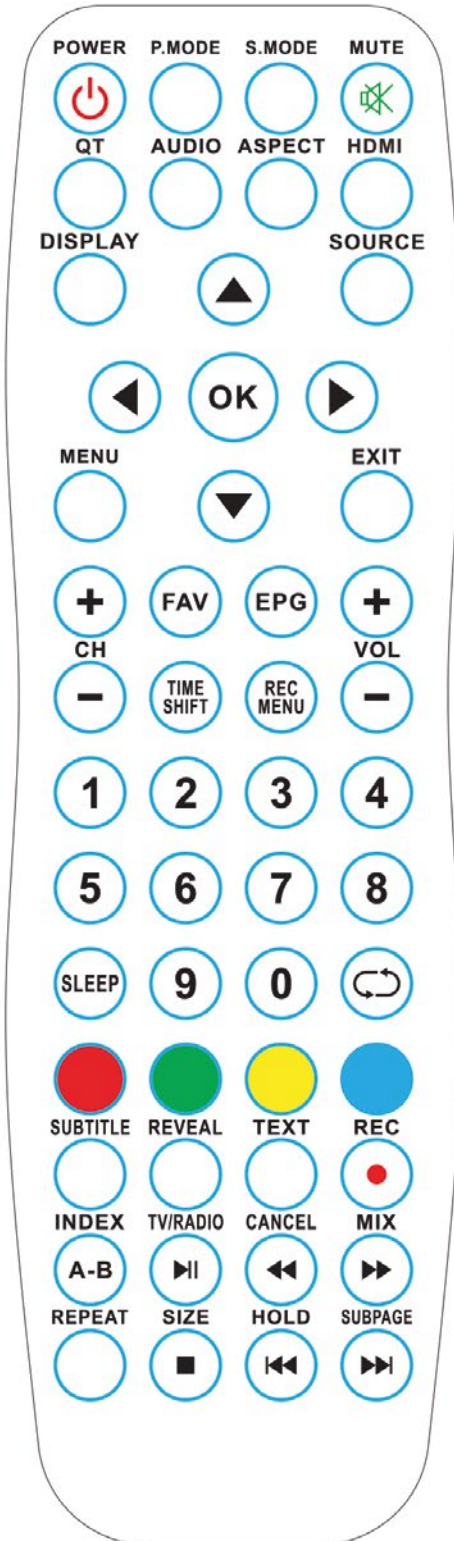

# Remote Control Unit

| No. | Button  | Description   |
|-----|---|---|
| 1   | POWER   | Set your TV to power on or standby mode   |
| 2   | P.MODE  | Select the picture mode   |
| 3   | S.MODE  | Select the sound mode   |
| 4   | MUTE  | Press to mute the sound. Press again to regain sound  |
| 5   | QT  | Quick Tune. Quick TV Channel Autotune button  |
| 6   | AUDIO   | Press to display the language of the audio in DTV   |
| 7   | ASPECT  | Press this button to select the aspect of screen  |
| 8   | HDMI  | Press this button to select the HDMI  |
| 9   | DISPLAY   | Press this button to display the information on current input   |
| 10  | SOURCE  | Press this button to display the input source   |
| 11  | MENU  | Allows you to navigate on the screen menus (OSD)  |
| 12  | EXIT  | Exit from the current menu or sub-menu. Press twice to enter HOME   |
| 13  |    | Allows you to navigate the on-screen menus and adjust the system settings to your preference  |
| 14  | FAV   | Selects favourite channels  |
| 15  | EPG   | Press to display EPG (Electronic Program Information)   |
| 16  | TIME SHIFT  | Press to switch to TIME SHIFT mode  |
| 17  | REC.MENU  | Press to switch to REC.MENU immediately (DTV only)  |
| 18  | CH+/-   | Press these two buttons to change channels up/down  |
| 19  | VOL+/-  | Press these two buttons to increase/decrease the volume   |
| 20  | 0-9   | Press 0-9 to select a TV channel directly. The channel will change after 2 seconds. Applicable for enter page number in TELETEXT mode |
| 21  | SLEEP   | Set the time for the TV to turn off automatically   |
| 22  |  | Return to the previously viewed program   |
| 23  | R (DELETE)  | Delete function button  |
| 24  | G (RENAME)  | Rename function button  |
| 25  | Y (MOVE)  | Move function button  |
| 26  | B (SKIP)  | Skip function button. Open and close the mouse  |
| 27  | SUBTITLE  | Press to select the subtitle language   |
| 28  | REVEAL  | Shows hidden words or pages by Teletext   |
| 29  | TEXT  | Switch on/off Teletext window   |
| 30  | REC/●   | Press to record the program immediately   |
| 31  | INDEX   | Returns to Index page by Teletext   |
| 32  | CANCEL  | Switches the Teletext window to the background; only the current page is not visible  |
| 33  | MIX   | Sets the transparency of Teletext window  |
| 34  | REPEAT  | DVD: repeat mode selection  |
| 35  | SIZE  | Zoom in or out of the Teletext window   |
| 36  | HOLD  | Holds on the current Teletext page  |
| 37  | SUBPAGE   | Displays a subpage of upper Teletext options  |

# Home Page

## What's New

There are recommended videos which can be updated every day.

Press ◀/▶ button to select the video, and then press ENTER key to play video you want.

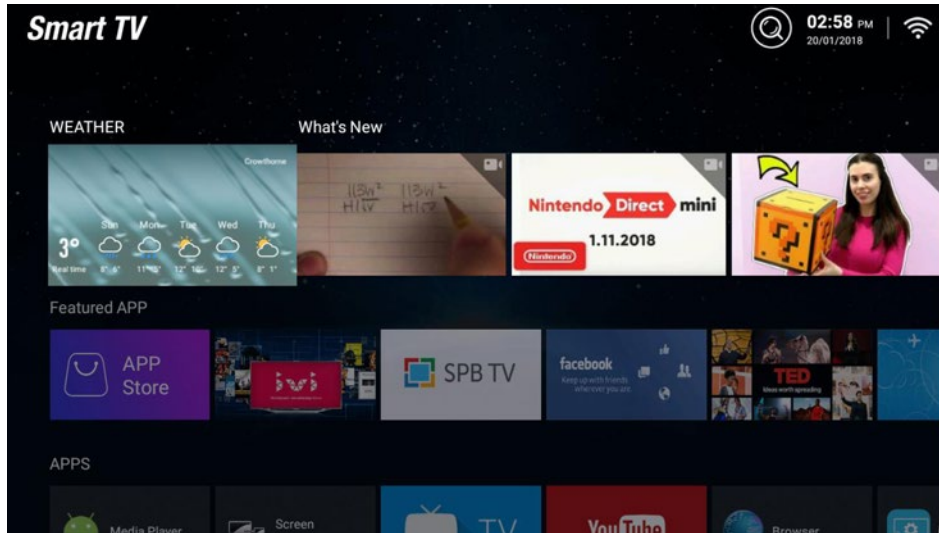

## Featured APP

There are the recommended APPS in APP Store, press Enter key to download the APPs from the Store, you can go to the APP Store to download other APPS.

# Home Page

Download Netflix from the APP Store.

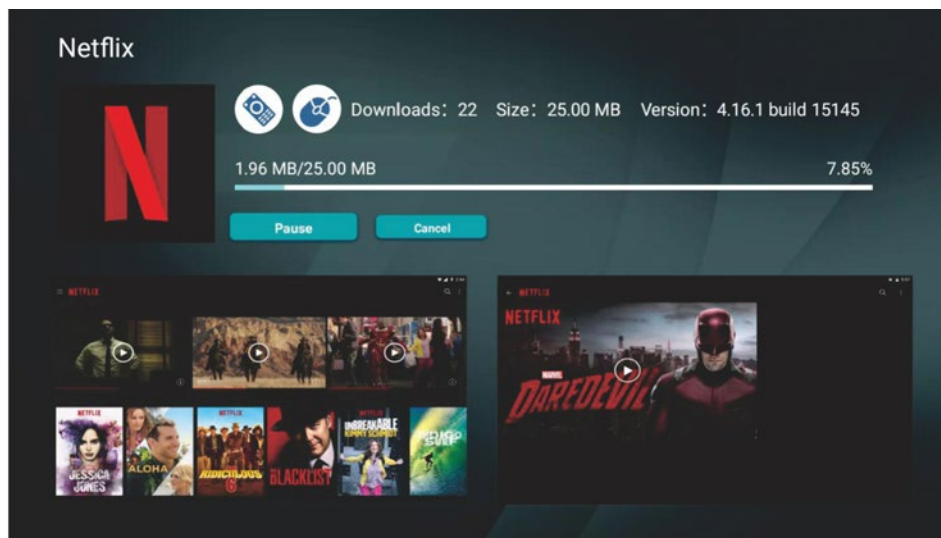
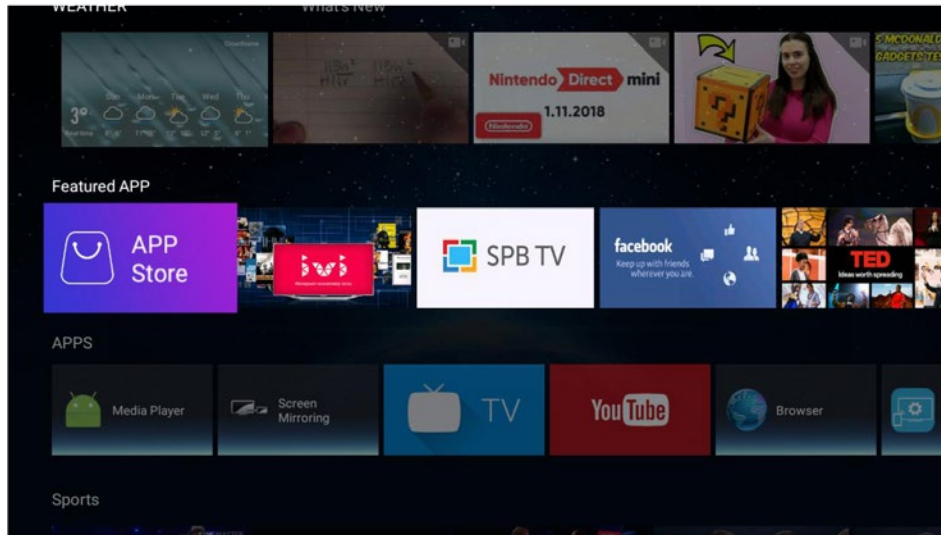

# Home Page

## APPS

This is part of the system preset in user installation applications.

Press ◀/▶ button to select APP, and then press ENTER key to run it.

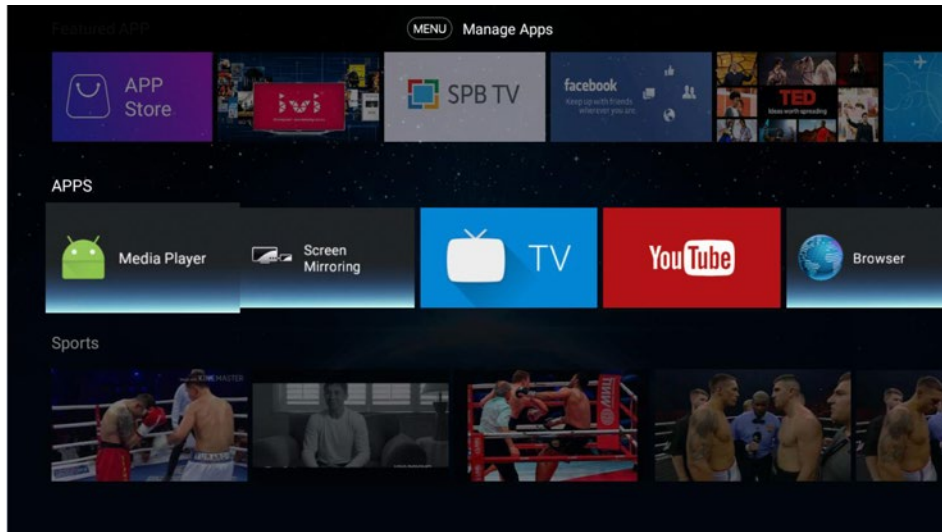

User can access the Internet by Browser APP.

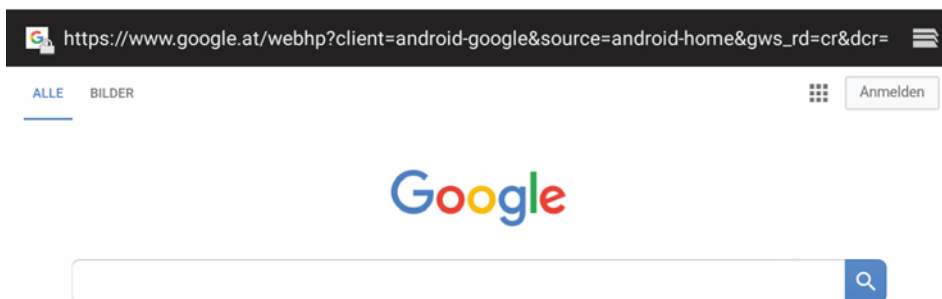

# Home Page

## Sports & Music

This part is a sports and music column.

Press ◀/▶ button to select the video, and then press ENTER key to play it.

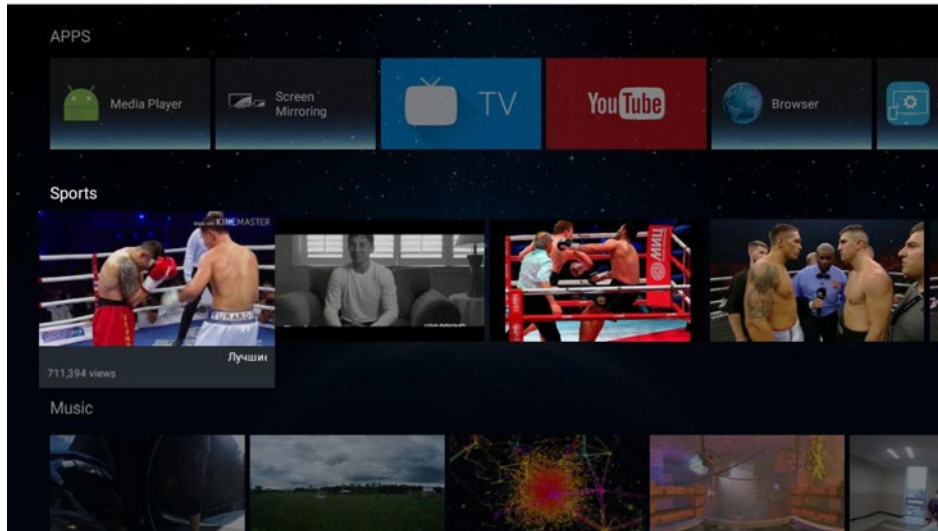

## Setting

Press ENTER key to access system settings.

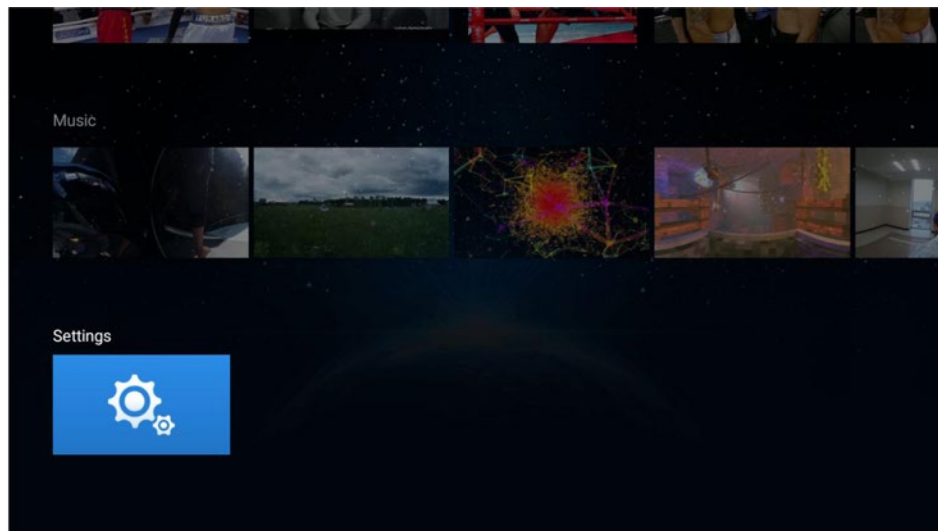

# Home Page

## Network Settings



Press ▲/▼ button to select the Network that you want to use.

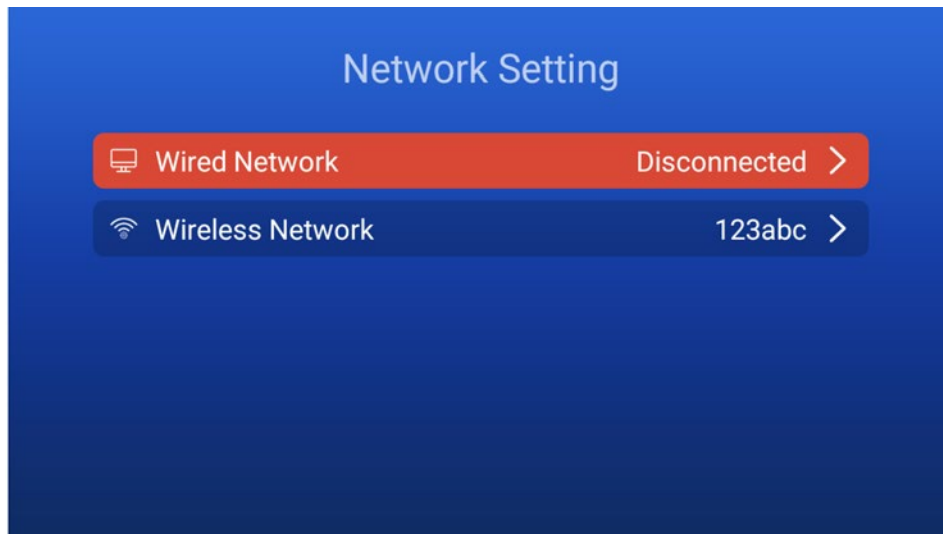



# Home Page

## Time Setting

Press ▲/▼ key to select the items, and then press ENTER key to modify it.



## Common

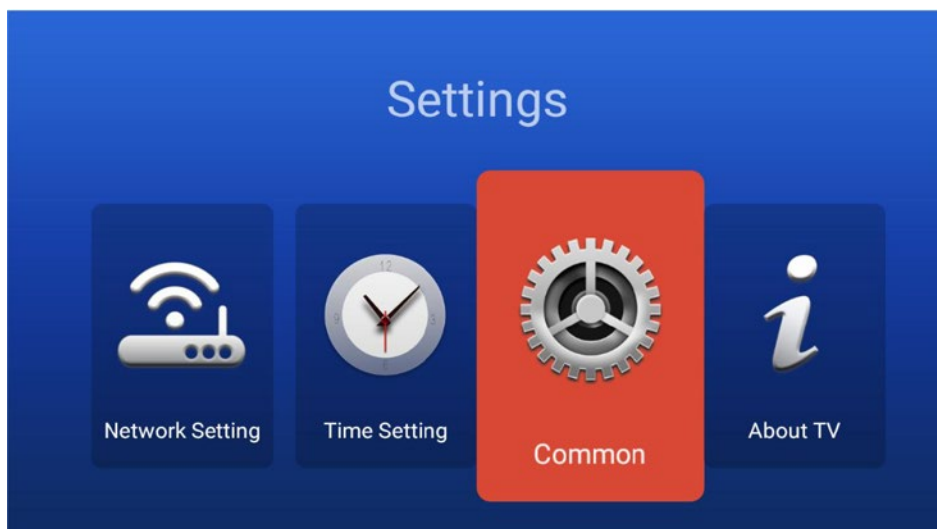

# Home Page

## Language Setting

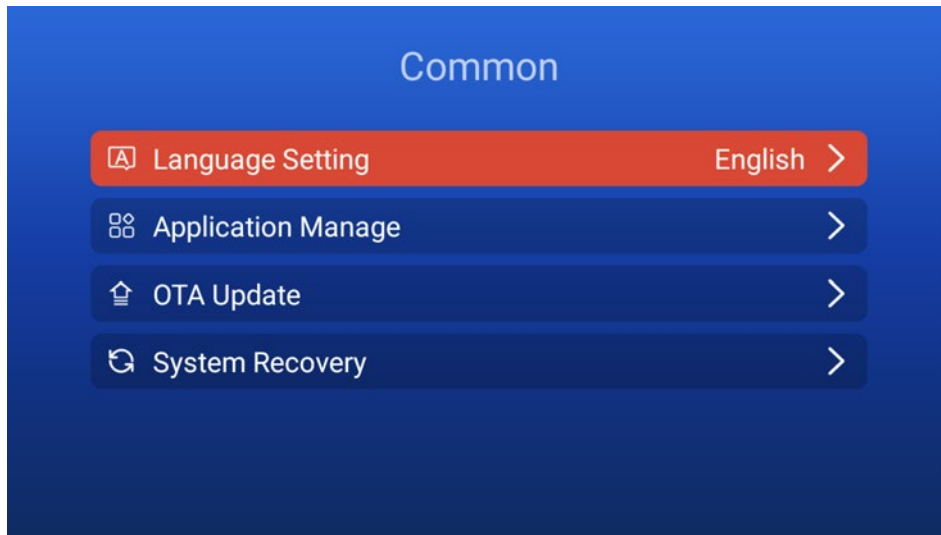

Press ▲/▼ key to select the system Language that you want, then press the Enter key to confirm. As the figure shows,

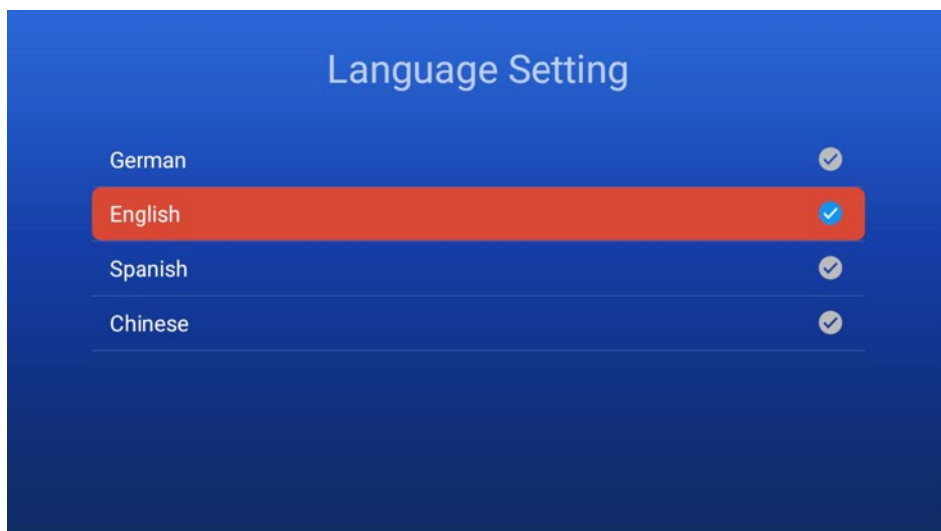

# Home Page

## Application Manage

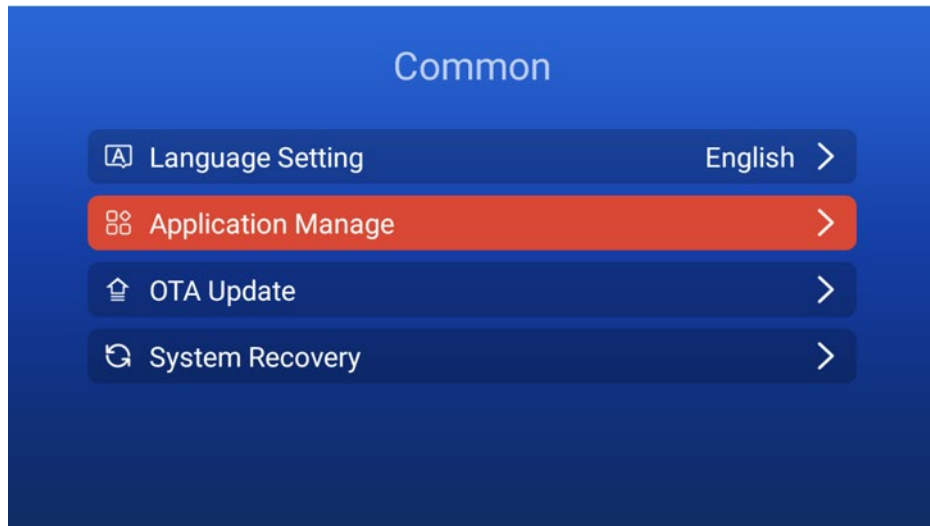

Press Enter key to select Installed Applications to see your downloaded apps.

You can uninstall apps that you have downloaded with Uninstalled Applications item. as the figure shows:



# Home Page

OTA Update

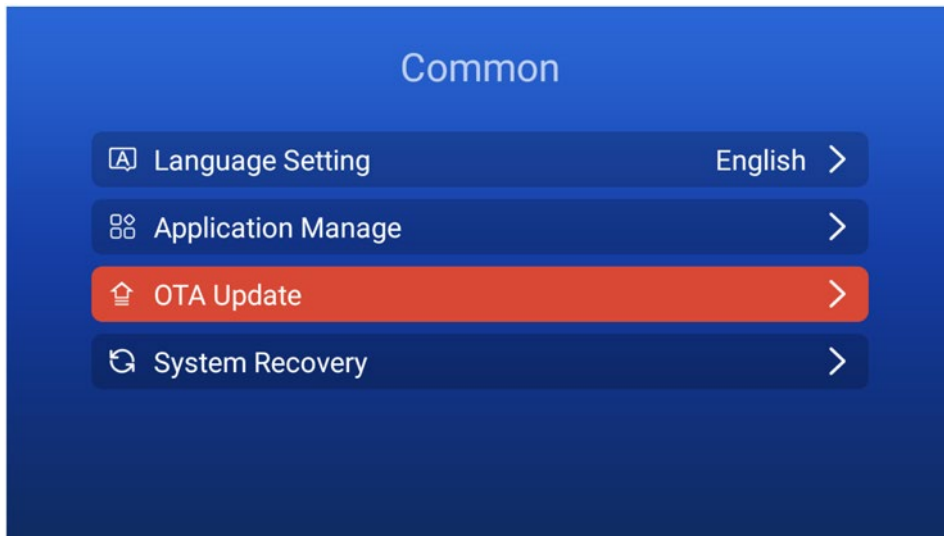

# Home Page

## System Recovery

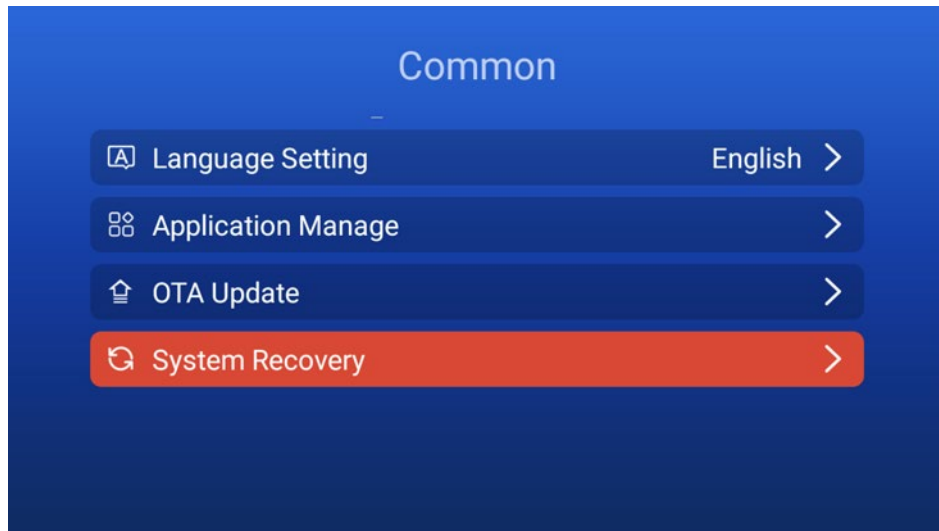

Click the "FACTORY DATA RESET" button to doe-System Recovery. All apps you have downloaded will be deleted.



# Home Page

## About TV

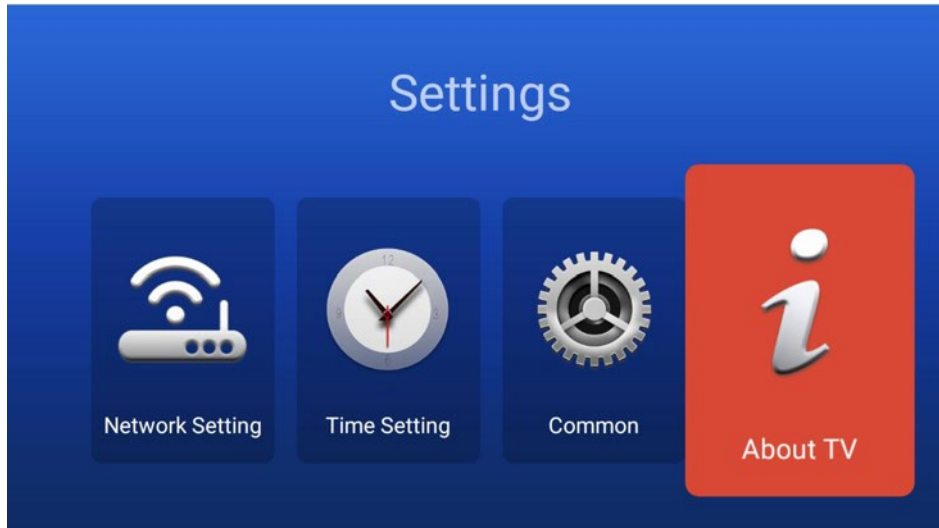

This part shows the system information.  
As the figure shows,



# Home Page

## Media Player

Note: Before opening MEDIA menu, plug in USB device or memory card

Press ▲/▼ button to select Media Player in the Home Page, and then press ENTER to access.

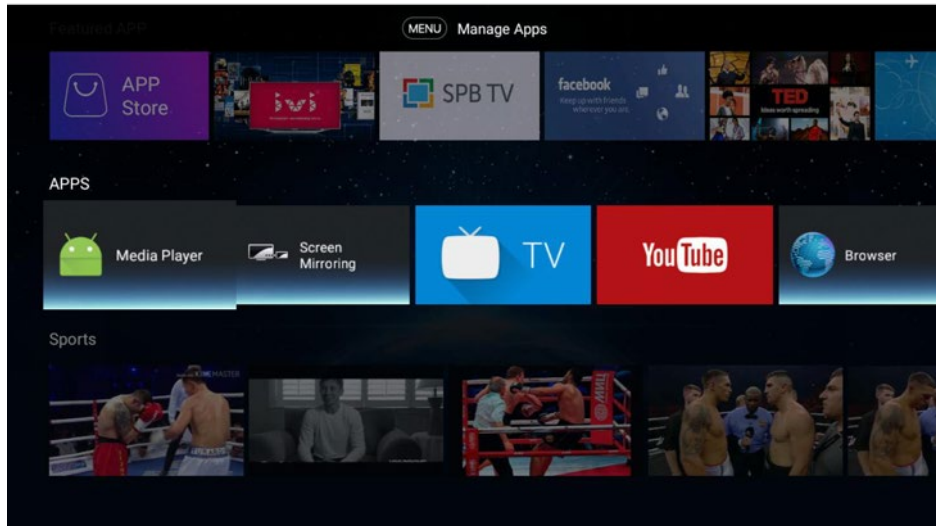

Press ◀/▶ key to select and press ENTER key to enter

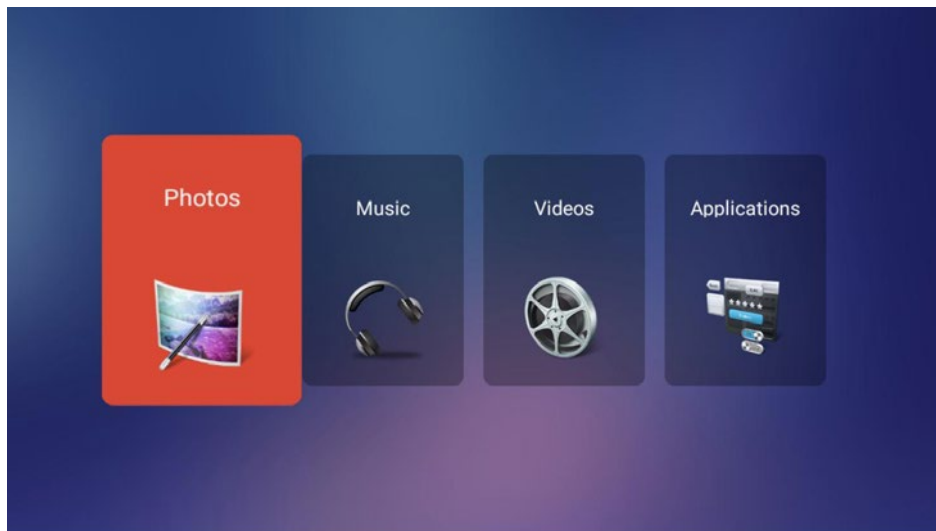

# Home Page

## Photos

The picture is for reference only.

Press ◀/▶ button to select Photo in the main menu, and then press ENTER button to enter.

Press EXIT button to return back to the previous menu.

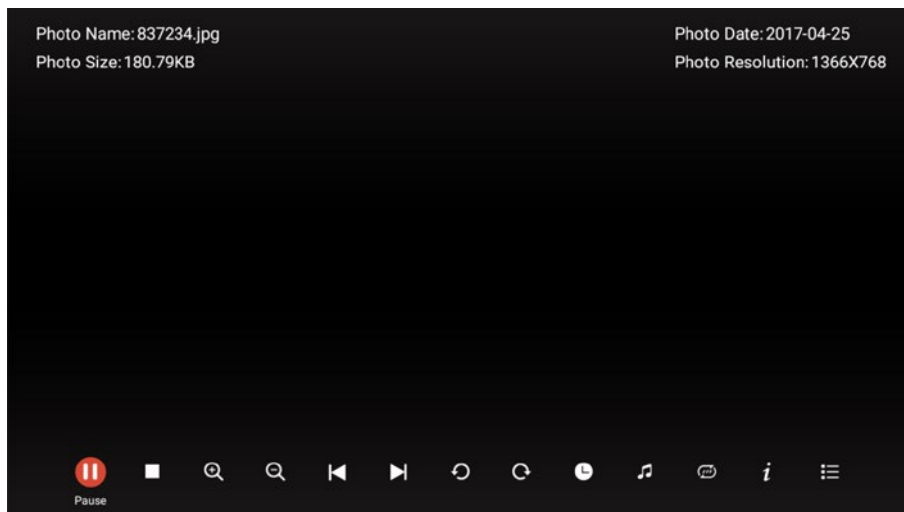
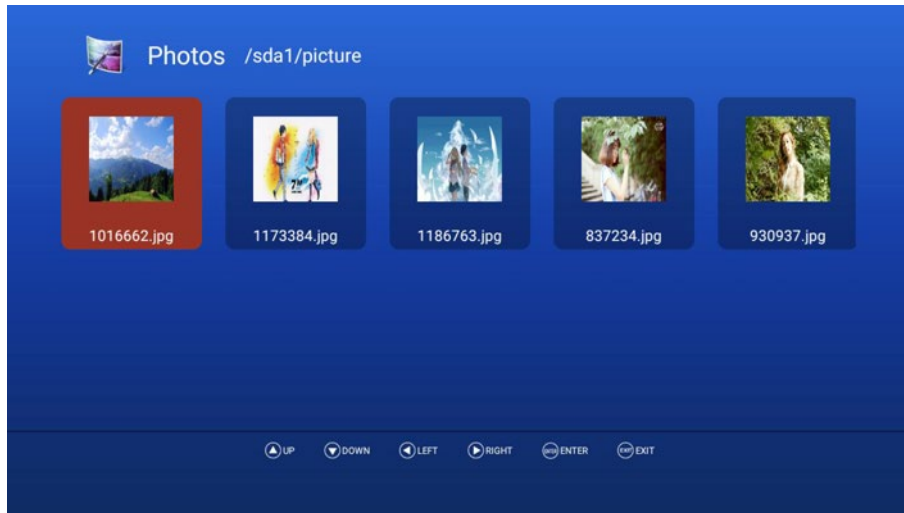

You can see the information of the current playing photo after you press the INFO button, then press ▶|| button to play or pause, you can see the playing state in the right.

Then press ▲/▼ ◀/▶ button to rotate the picture.

**Notes:** Other menu and description are the same as that for Movie menu.



# Home Page

## Music

The picture is for reference only.

Press ◀/▶ button to select Music in the main menu, and then press ENTER button to enter.

Press EXIT button to return back to the previous menu.

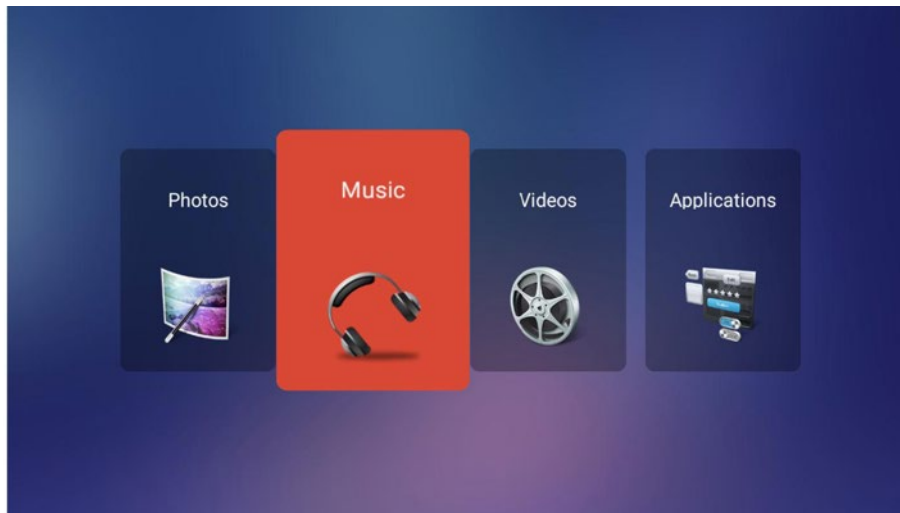

Press ▲/▼ button to select the song you want to listen, and then press ENTER or ▶|| or ▶ button to play.

Press ◀ button to return back to the previous menu.

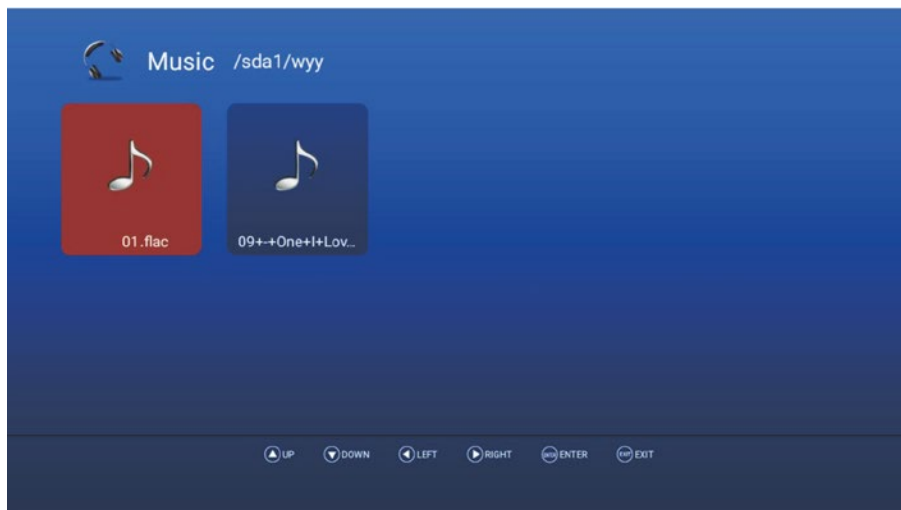

# Home Page

You can see the information of the current playing song at the left on the menu.

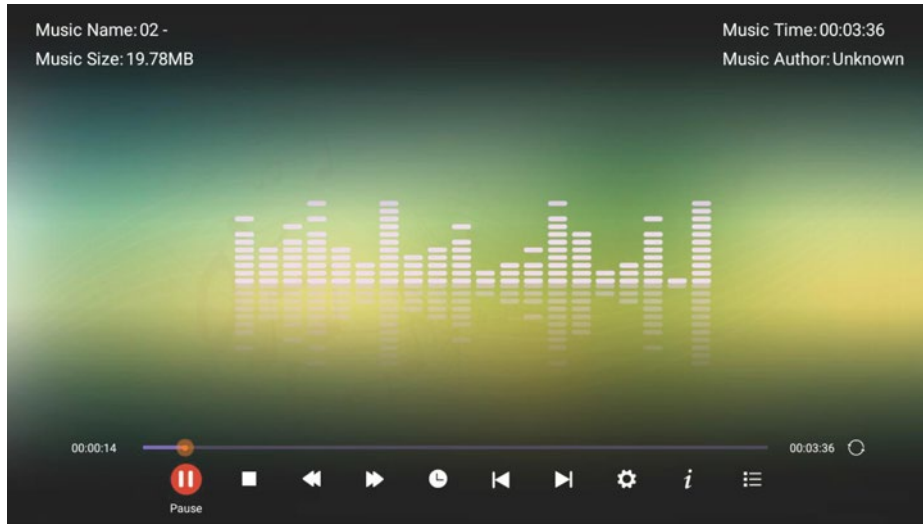

## Video

The picture is for reference only.

Press ◀/▶ button to select Video in the main menu, then press ENTER button to enter.

Press EXIT button to return back to the previous menu.

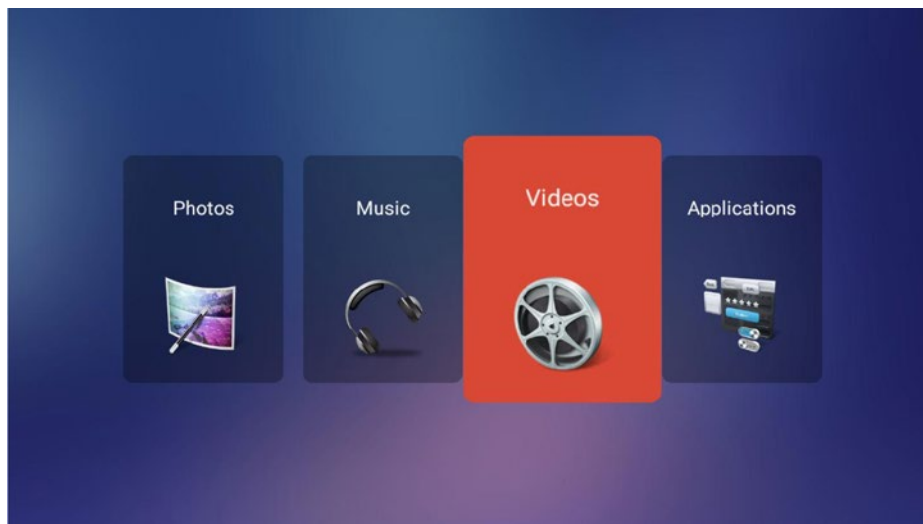

# Home Page

Press ◀/▶ and ▲/▼ button to select the folder that you want to view.

Press ENTER button to select the sub folder.

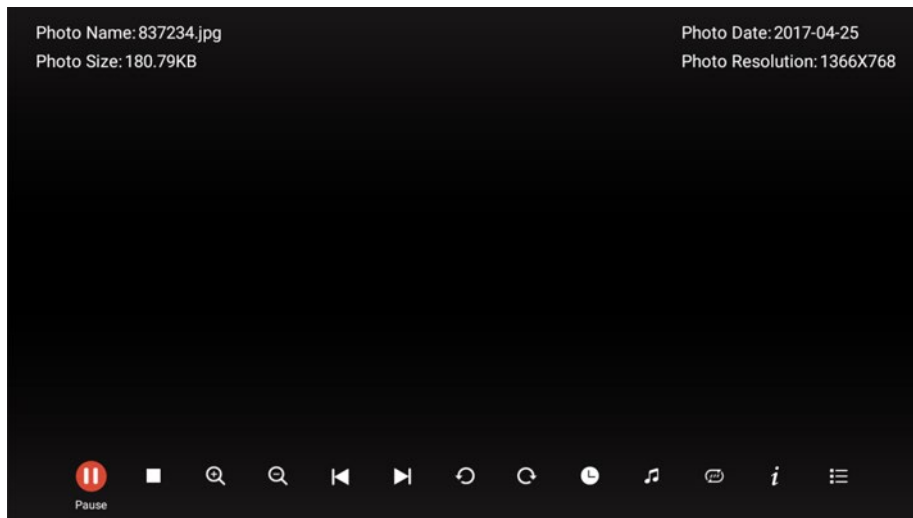
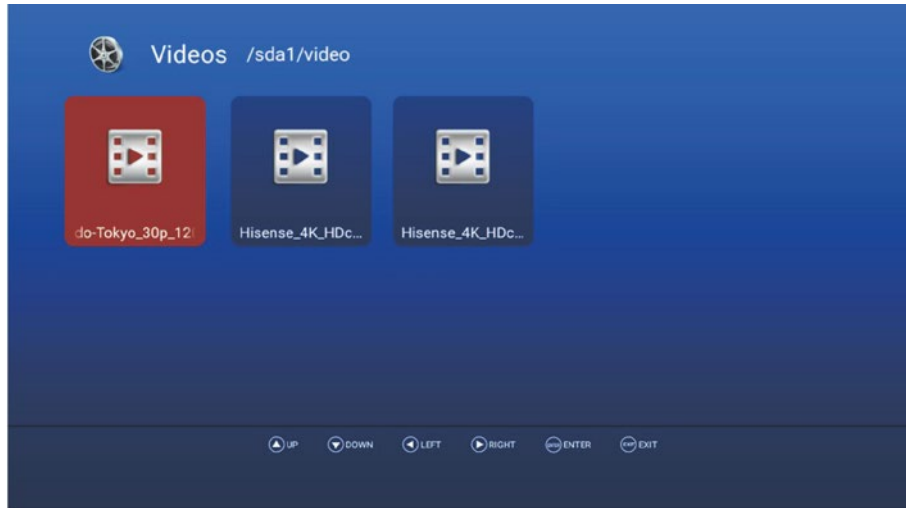

Press ENTER button or ▶|| button to play.

Press ■ button or EXIT button to stop playing.

Press the ◀ button to return back to previous page.

You can see the information of the current playing media at the first few seconds or after pressing INFO button.

# Home Page & TV Apps

## Applications

The picture is for reference only.

Press ◀▶ button to select Application in the main menu, then press ENTER button to enter OK.

You can install applications by this selection.

Press EXIT button to return back to the previous menu.

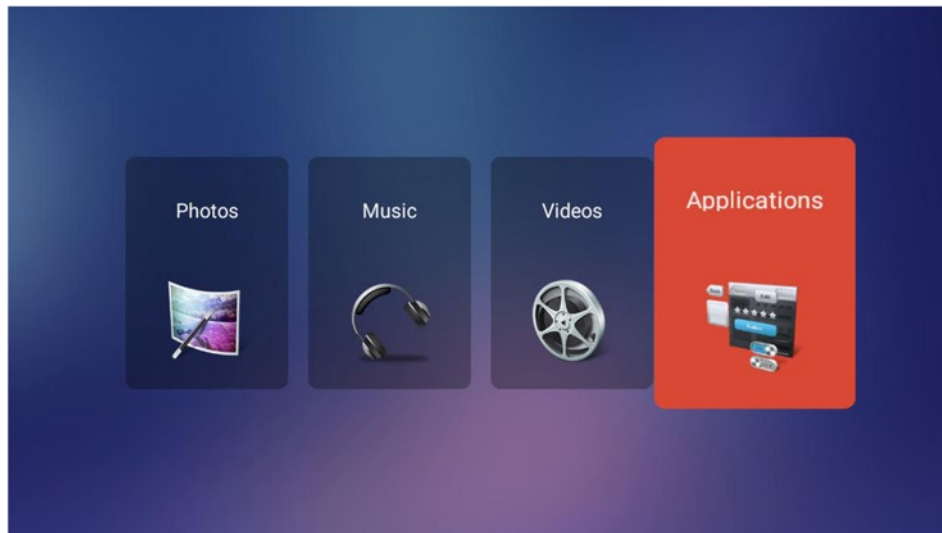

## TV Apps

### INPUT SOURCE

1. Press SOURCE button to display the input source list.

2. Press ...IT button to select the input source you want to watch.

3. Press ENTER button to enter the input source.

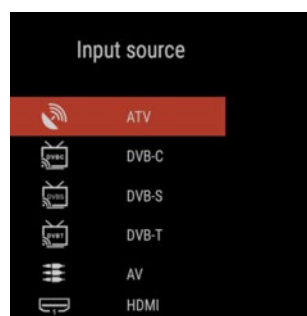

# TV Apps

## Main Menu

Press MENU button to display the MAIN OSD MENU.

Press ▲/▼ button to select the MENU you want.

Press ENTER button or ► button to enter the sub menu, and press ◀ button to return back to the previous menu.

Press ▲/▼ button to select the option and then press ENTER button or ► button to enter the sub menu, press ◀/▶ button to adjust the value or press ◀/▶ button to select sub menu.

You can press EXIT button to save and return back to the previous menu, and press EXIT button to exit the entire menu.

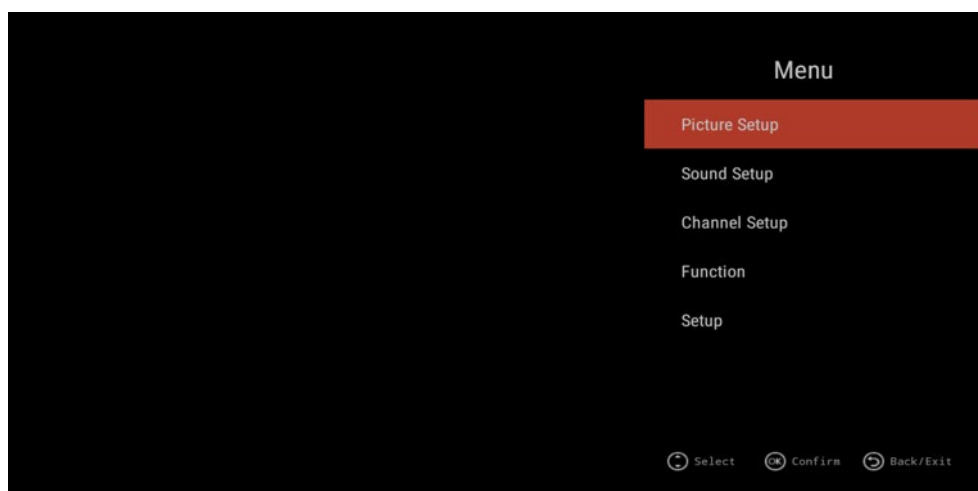

## Picture Setup

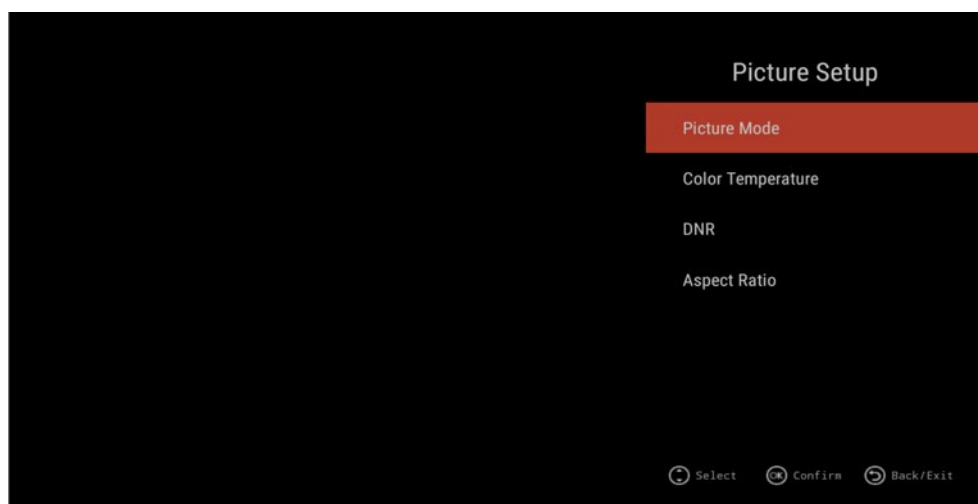

# TV Apps

## Picture Mode

Press ▲/▼ button to select Picture Mode, then press ENTER button to enter (Available Picture Mode: Standard, Dynamic, Mild, User).

You can adjust the value of brightness, contrast, sharpness, colour, when the picture is in User mode.

**TIPS:** You can press P-MODE button on the remote control again and again to change the picture mode directly

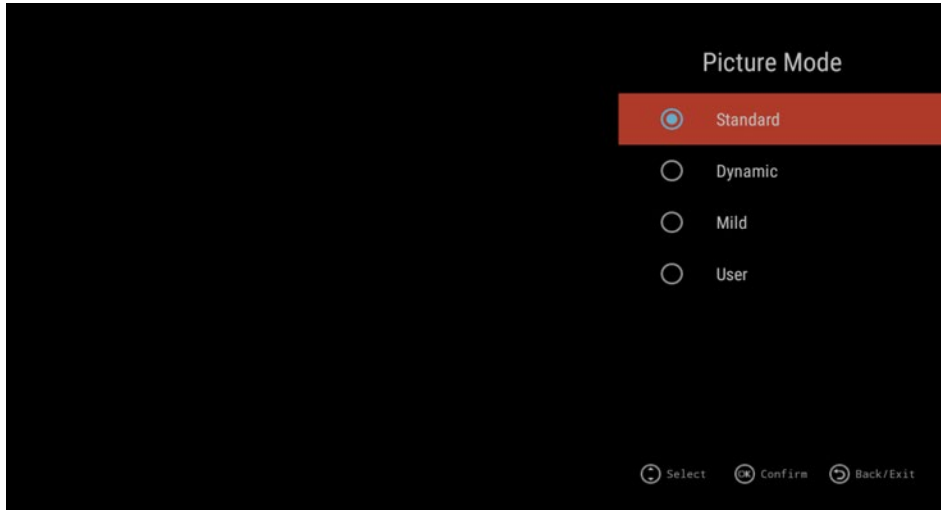

## Colour Temperature

Press ▲/▼ button to select Colour Temperature, then press ENTER button to enter and ◀/▶ button to select: Standard, Cool, Warm.

## DNR

Press ▲/▼ button to select DNR, and then press ENTER button to enter and ◀/▶ button to select Off, Low, Middle, High.

## Aspect Ratio

Press ▲/▼ button to select Aspect Ratio, then press ENTER button to enter and press ◀/▶ button to adjust. Then press EXIT button to return back the previous menu directly.

# TV Apps

## Sound Setup

1. Press ▲/▼ button to select the option that you want to adjust in the Sound menu, then press ENTER button to enter.
2. Press ◀/▶ button to adjust or press ▲/▼ to select, and press ENTER button to select sub menu.
3. After finishing your adjustment, press MENU button to save and return back to the previous menu, or press EXIT button to exit the entire menu.

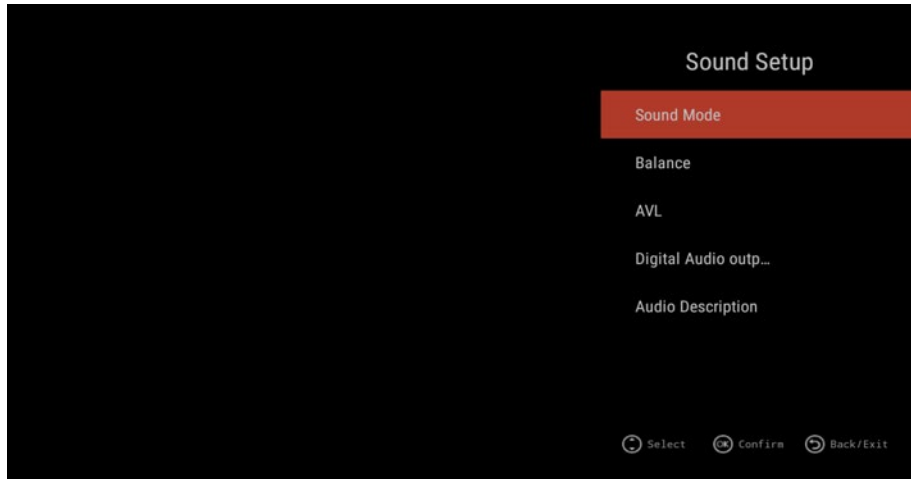

## Sound mode

Press ▲/▼ button to select Sound Mode, and then press ENTER button to confirm.  
(Available Sound mode: Standard, Movie, Music, User).

You can adjust the value of bass and treble, when the sound is in User Mode.

**TIPS:** You can press S-MODE button on the remote control to change the Sound Mode directly.

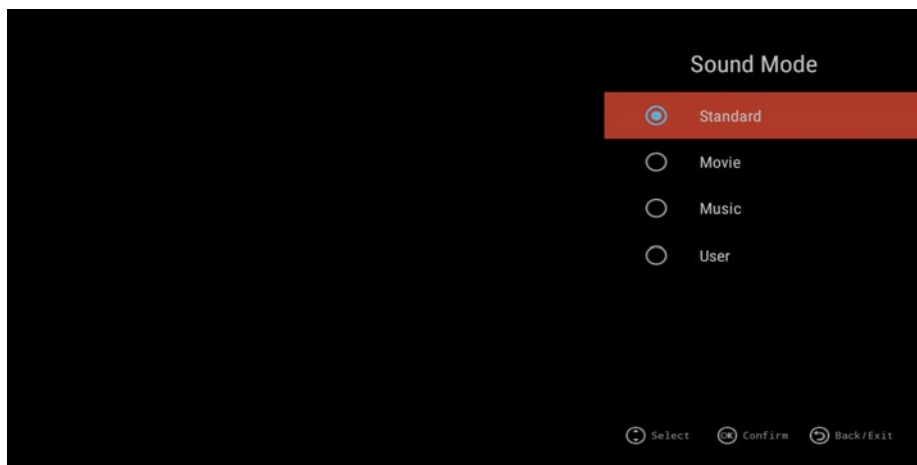

# TV Apps

## Balance

Press ▲/▼ button to select Balance, then press ◀/▶ button to adjust.  
Then press EXIT button to return back the previous menu directly.

## AVL

Press ▲/▼ button to select AVL, then press ENTER button to adjust.  
Then press EXIT button to return back the previous menu directly.

## Digital Audio Output

Press ▲/▼ button to select SPDIF Output, then press ENTER button to confirm  
(Available SPDIF mode: AUTO, PCM, OFF).

Then press ENTER button or ▶ button to enter and press ◀/▶ button to adjust, then press EXIT button to return back the previous menu directly.

## Audio Description

Press ▲/▼ button to select Audio Description then press ENTER button to adjust (Available AD ON/OFF).  
When you select AD ON, you can press ◀/▶ button to adjust Mixing Level.

## Channel Setup

Press MENU button to display the main menu.

Press ▲/▼ button to select Channel Setup in the main menu, then press ENTER to enter.

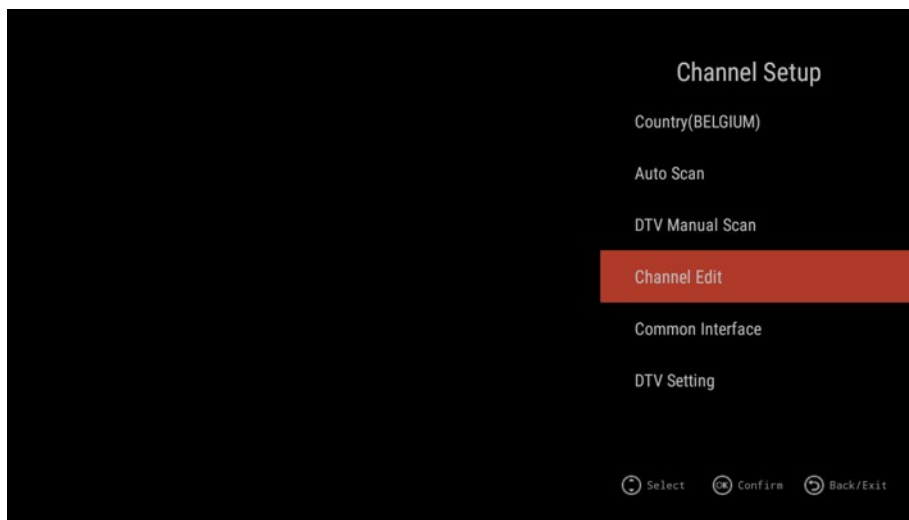

1. Press ▲/▼ button to select the option that you want to adjust in the Channel Setup menu, then press ENTER to enter.
2. After finishing your adjustment, press EXIT button to save and return back to the previous menu and press EXIT button to exit the entire menu.



# TV Apps

## Country

Press ▲/▼ button to select Country, and then press ENTER button to confirm

## Auto Search

Press ▲/▼ button to select Auto Search, and then press ENTER button to do auto search

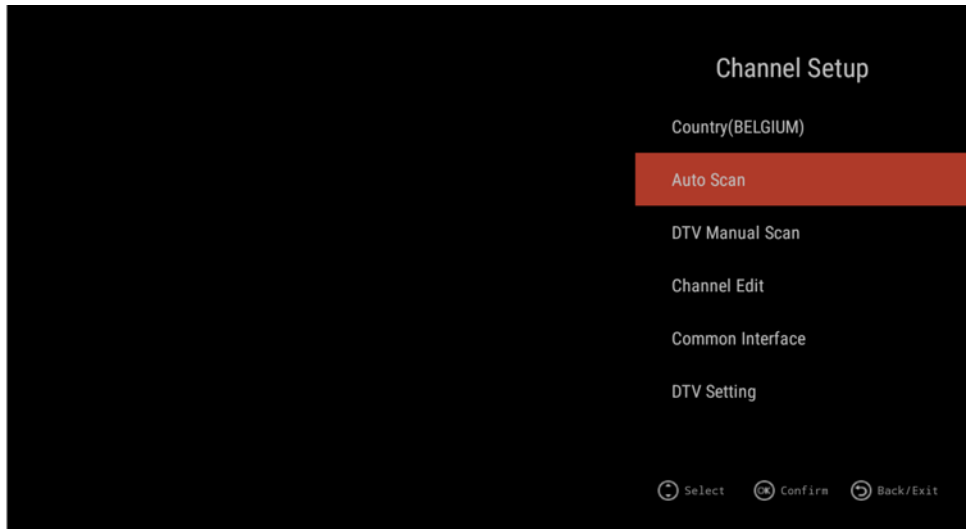

## DTV Manual Scan

Press ▲/▼ button to select, press ◀/▶ button to adjust, and then press EXIT button to return pre-menu, The menu will appear as follows:

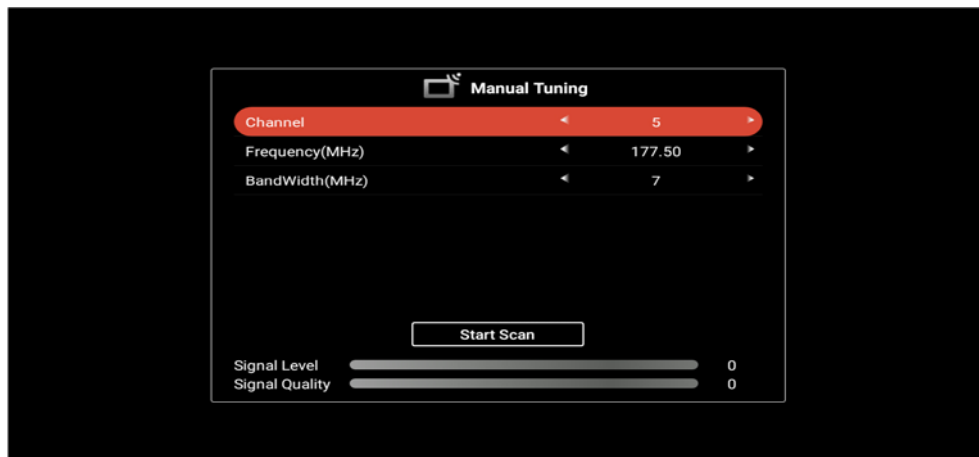

## Channel Edit

Press ▲/▼ button to select channel Edit, and then press ENTER button to enter, you can use the Four Colour keys to do Delete/Skip/Swap/Lock function, and press Fav. Key to set

# TV Apps

The menu will appear as follows:

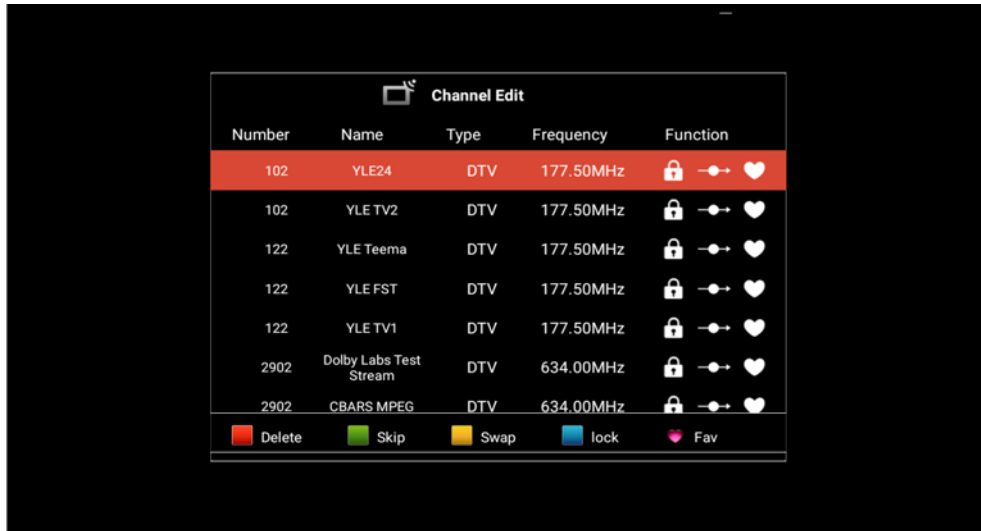

| Number | Name                   | Type | Frequency | Function |
|--------|------------------------|------|-----------|----------|
| 102    | YLE24                  | DTV  | 177.50MHz | 🔒 →👉❤️   |
| 102    | YLE TV2                | DTV  | 177.50MHz | 🔒 →👉❤️   |
| 122    | YLE Teema              | DTV  | 177.50MHz | 🔒 →👉❤️   |
| 122    | YLE FST                | DTV  | 177.50MHz | 🔒 →👉❤️   |
| 122    | YLE TV1                | DTV  | 177.50MHz | 🔒 →👉❤️   |
| 2902   | Dolby Labs Test Stream | DTV  | 634.00MHz | 🔒 →👉❤️   |
| 2902   | CBARS MPEG             | DTV  | 634.00MHz | 🔒 →👉❤️   |

🔴 Delete   🟢 Skip   🟡 Swap   🔵 lock   🟡 Fav

## Common Interface

Press ▲/▼ button to select Common Interface, and then press ENTER button to enter. You can check the CAM/CI card information by this menu.

## DTV Setting

Press ▲/▼ button to select DTV Setting, and then press ENTER button to enter. The menu will appear as follows:

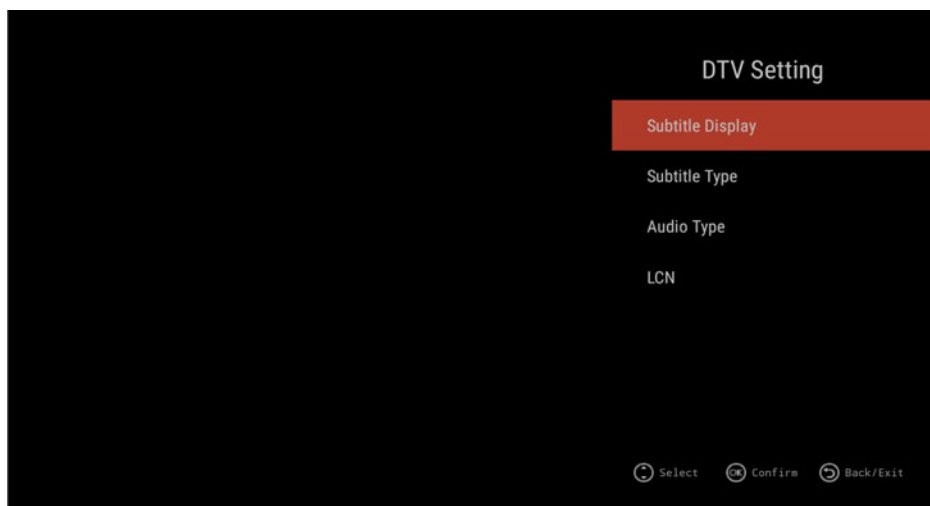

# TV Apps

## Subtitle Display

Press ENTER key to enter the sub menu, you can press E N T E R key to select Subtitle ON/OFF.  
When the subtitle set to ON, you can select subtitle language by Subtitle language item.  
Press EXIT button to return pre-menu.

## Subtitle Type

Press ENTER key to enter the sub menu, you can press ENTER key to select Normal subtitle or the subtitle for Hard of Hearing .  
Press ENTER key to select Prefer Subtitles 1/Prefer Subtitles 2.  
Press EXIT button to return pre-menu.

## Audio Type

Press ENTER key to enter the sub menu, you can press ENTER key to select Normal Audio or the Audio for Hard of Hearing .  
Press ENTER key to select Prefer Audio 1/Prefer Audio 2.  
Press EXIT button to return pre-menu.

## LCN

Press ENTER key to enter the sub menu, you can press ENTER key to select LCN ON/OFF  
Press EXIT button to return pre-menu.

## Function

Press ▲/▼ button to select Function, and then press ENTER button to enter.

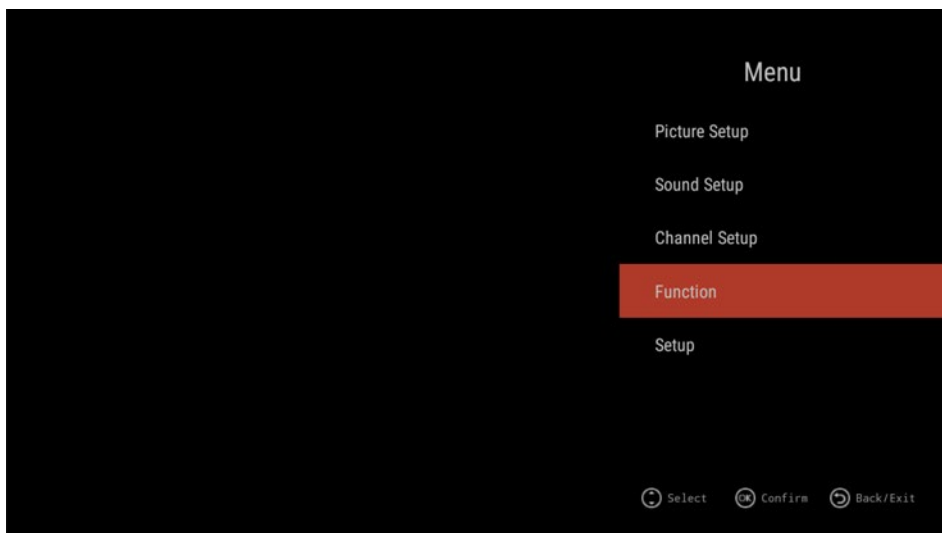

# TV Apps

## Teletext Language

Press ENTER key to enter the sub menu,you can press ENTER key to select the Teletext Language (West Europe/East Europe/Russian/Arabic).

Press EXIT button to return pre-menu.

## System Lock

Press ENTER key to enter the sub menu,you will see a graphic as follows.

Enter the default PIN 0000, you will enter the Parental controls menu.

Press EXIT button to return pre-menu.

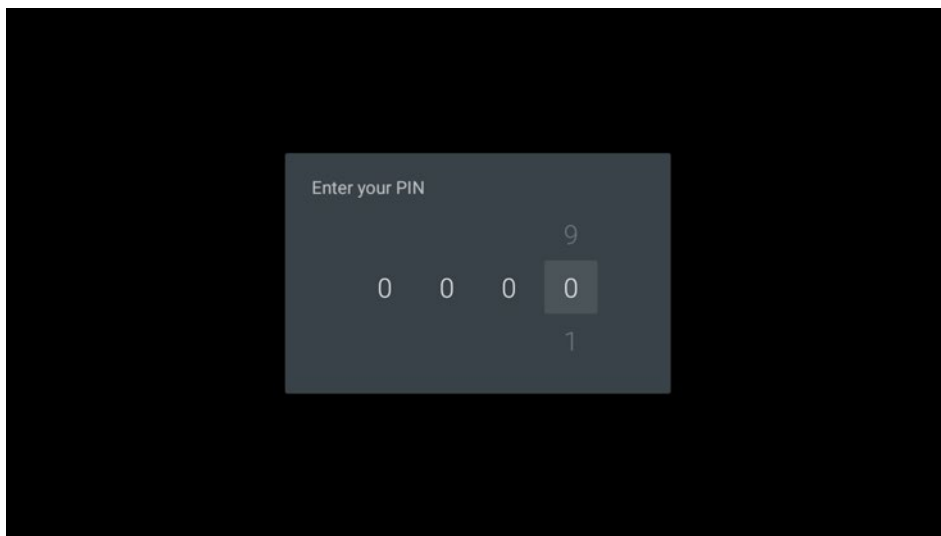

## Parental controls

Press ▲/▼ button to select the ON/OFF,RATING/Change PIN item and press ENTER button to confirm

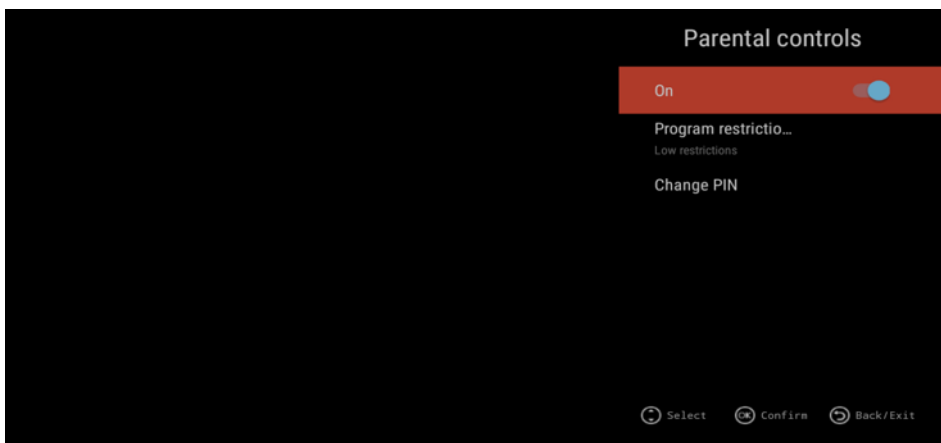

# TV Apps

## Auto Power Down

Press ENTER key to enter the sub menu.

Press ▲/▼ button to select Off/1 hour/2 hour/3 hour/4 hour item and then press ENTER button to confirm.

Press EXIT button to return pre-menu.

## Record Menu (DTV Source only)

Press ENTER key to enter the sub menu,you will see a graphic as follows.

Press ▲/▼ button to select the items and then press ENTER button to set.

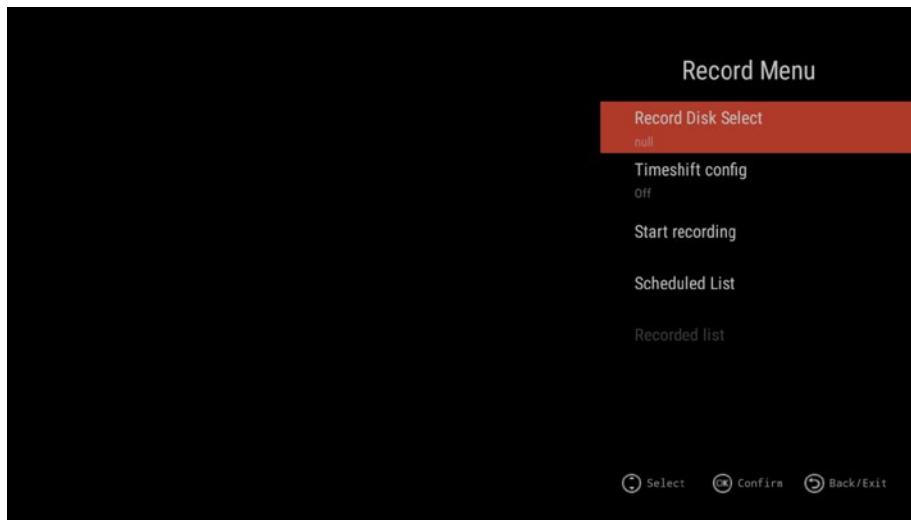

## CEC

Press ENTER key to enter the sub-menu.

Press ▲/▼ button to select HDMI Control /Device auto power off/TV auto power on/ARC enable item and then press ENTER button to change.

Press EXIT button to return pre-menu.

## Setup

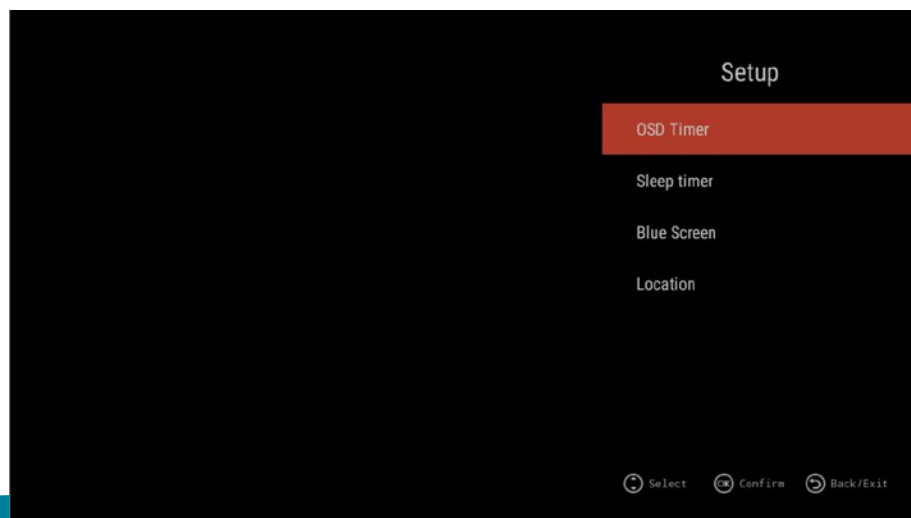

# TV Apps

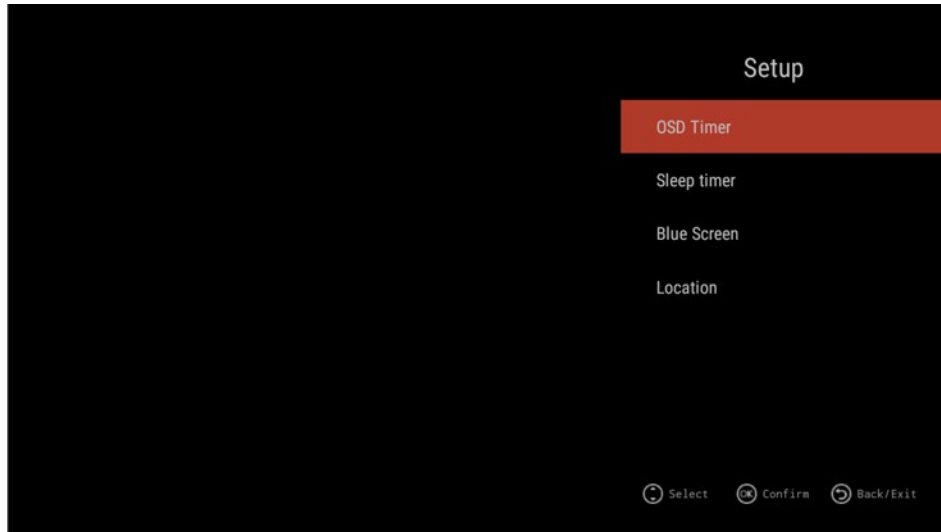

## **OSD Timer (OSD display time)**

Press ▲/▼ button to select OSD Timer.

Press ENTER button to enter.

Press ▲/▼ to select Off/10s/20s/30s/40s/50s/60s items and then press ENTER button to confirm.

Press EXIT button to return pre-menu.

## **Sleep Timer (power off time)**

Press ▲/▼ button to select Sleep Timer.

Press ENTER button to enter.

Press ▲/▼ to select Off/00:15/00:30/01:00/01:30/02:00/03:00 items and then press ENTER button to confirm.

Press EXIT button to return pre-menu.

## **Blue Screen**

Press ▲/▼ button to select Blue Screen.

Press ENTER button to enter and then press ENTER button to change the ON/OFF selection.

Press EXIT button to return pre-menu.

## **Location**

Press ▲/▼ button to select Location.

Press ENTER button to enter and then press ENTER button to change the Home/Store selection.

Press EXIT button to return pre-menu.

# Troubleshooting

| Area                                 | Problem                         | No                  | Potential Cause  | Solution   |
|--------------------------------------|---------------------------------|---------------------|--|--|
| Power                                | No red standby light on TV      |                     | Power supply not receiving/<br>giving power                      | Check connection between power lead and PSU - green light should be visible on PSU   |
|                                      | Standby light stuck on red      |                     | Remote not emitting signal                                       | Try new battery in the remote  |
|                                      | Standby light green; no picture |                     | Power supply not receiving/<br>giving power                      | Check connection between power lead and PSU - green light should be solid on PSU   |
| Signal/<br>Input                     | DTV - No signal                 | 1                   | Not tuned in with channels                                       | Auto-tune using DTV<br>Auto-search in menu   |
|                                      |                                 | 2                   | Aerial problem   | Try TV on another aerial in a different location - if it picks up channels, likely an issue with the location of the bathroom aerial |
|                                      | DTV - interference on screen    |                     | Caused by equipment around the aerial                            | Move aerial to different position away from any power cabling  |
|                                      | HDMI - No signal                | 1                   | No signal received from source                                   | Check connection on TV and source  |
|                                      |                                 | 2                   | Source emitting 4K signal  | Scale down resolution from source to 1920x1080 (1080p)   |
|                                      | USB - Media cannot be played    |                     | File format not compatible                                       | Change file format and attempt to play   |
| Smart screen not moving with buttons |                                 | Stuck in mouse mode | Press blue button on remote to toggle mouse mode off to use menu |  |
| Audio                                | No sound - Speakers             | 1                   | Mute   | Try mute button on remote  |
|                                      |                                 | 2                   | Sound trying to route to external speakers                       | Disconnect audio out/<br>earphone port   |
|                                      | No sound - external speakers    |                     | No signal between TV and external speakers                       | Check audio connection at either end   |

# WEEE Compliance Scheme & Netflix

We are a producer of Electrical and Electronic Equipment (EEE) and is therefore obligated under the Waste Electrical and Electronic Equipment (WEEE) Regulations. We are fully compliant with all responsibilities as a registered member of UK government approved WEEE Compliance Scheme.

We have formally documented policies relating to the WEEE Regulations and we review our processes on a formalised and regular basis to ensure we remain fully compliant.

The UK WEEE Regulations were first introduced in 2007 with the aim of reducing the amount of EEE ending up in landfill. As per the requirements of the Regulations, we finance the recovery and recycling of WEEE when it reaches the end of its life and ensure our EEE products are marked accordingly with a crossed out wheeled bin symbol and a date mark. We also provide information on reuse and environmentally sound treatment of the products.

## NETFLIX

### Using Netflix on your Bathroom Smart TV

Please read this guide before using Netflix on your new television. This will inform you on how to operate key functions. You will require the email address & password registered to your Netflix account. If you do not have an account, we recommend that you do to [www.netflix.com](http://www.netflix.com) and register via the web.

#### Logging in

On first time logging in to Netflix after downloading it, you will be faced with the intro screen and will have to log in to use the app. To log in, you will need to access the 'Sign In' area.

1. On the TV remote, press the Blue circle button. This will switch the TV to 'mouse mode' and a cursor will appear on the screen
2. Use the arrow buttons to move the cursor up to the 'Sign In' button at the top right
3. This will take you to the next screen to enter your email address and password and bring up a keyboard automatically. Use the arrow keys to operate the on-screen keyboard

#### Navigating the 'Download & Go'

After logging in, you will have a prompt screen on the 'Download & Go' functionality of Netflix. To navigate past this:

1. On the TV remote, press the Blue circle button. This will switch the TV to 'mouse mode' and a cursor will appear on the screen
2. Use the arrow buttons to move the cursor down to 'OK' option and press the Enter button on the remote

You will now be on the Netflix home screen

#### Navigating the Categories

Netflix relies on a row format to separate different categories. To scroll through the categories:

1. On the TV remote, press the Blue circle button twice. A small graphic will appear at the bottom right with 4 directional arrows.
2. Use the Up & Down arrow buttons on the remote to scroll between the different categories
3. Use the Left & Right arrow buttons on the remote to scroll through a category to see all of the available shows

#### Selecting a show

To select a show to watch

1. On the TV remote, press the Blue circle button. This will switch the TV to 'mouse mode' and a cursor will appear on the screen
2. Use the arrow keys to navigate to a show you want to