

# Operation, Parts



## 695 / 795 / 1095 / 1595 / Mark IV HD/ Mark V HD/ Mark VII HD/ Mark X HD Electric Airless Sprayers 3A6342F

EN

***For professional use only. Not approved for use in explosive atmospheres or hazardous locations. For portable airless spraying of architectural paints and coatings.***

**Models: 695 / 795 / 1095 / 1595 / Mark IV HD/ Mark V HD/ Mark VII HD/ Mark X HD**

**3300 psi (228 bar, 22.8 MPa) Maximum Working Pressure**

See page 4 for additional model information.



### Important Safety Instructions

Read all warnings and instructions in this manual and in Related Manuals listed on page 2 before using the equipment. Be familiar with the controls and the proper usage of the equipment. Save all instructions.

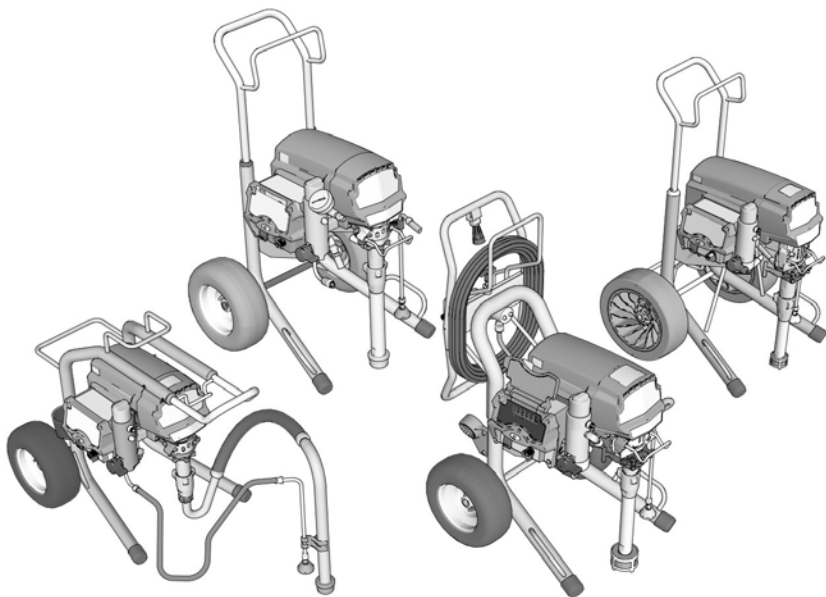

***Use only genuine Graco replacement parts.  
The use of non-Graco replacement parts may void warranty.***

PROVEN QUALITY. LEADING TECHNOLOGY.

## Before You Spray

### **Review Warnings for Important Safety Information**

Important! Read carefully and practice good safety habits.

### **Related Manuals**

3A6285	Contractor PC Spray Gun
311254	Flex Plus Spray Gun
309495	Heavy-Duty InLine Spray Gun
308491	Heavy-Duty Texture Spray Gun
3A6584	Displacement Pump
3A6583	ProConnect™ Displacement Pump





Manuals can also be found at [www.graco.com](http://www.graco.com)

## Contents



<b>Before You Spray</b> .....	<b>2</b>
<b>Contents</b> .....	<b>3</b>
<b>Models</b> .....	<b>4</b>
<b>Warnings</b> .....	<b>7</b>
<b>Know Your Sprayer</b> .....	<b>11</b>
<b>Know Your Controls</b> .....	<b>14</b>
<b>Setup</b> .....	<b>15</b>
Assemble Your Sprayer .....	15
QuikReel™ .....	16
Grounding .....	17
Power Requirements .....	17
Extension Cords .....	17
Pails .....	17
<b>Start Up</b> .....	<b>18</b>
Pressure Relief Procedure .....	18
10/16 Amp Switch .....	19
15/20 Amp Switch .....	19
Flush Storage Fluid .....	19
Strain the Paint .....	20
Fill Pump (Prime Pump) .....	21
Fill Spray Gun and Hose .....	21
Refilling Paint Pail .....	22
<b>Spraying</b> .....	<b>23</b>
<b>Cleanup</b> .....	<b>26</b>
<b>WatchDog</b> .....	<b>29</b>
<b>BlueLink™ App</b> .....	<b>30</b>
<b>LED Display</b> .....	<b>32</b>
<b>Maintenance</b> .....	<b>35</b>
<b>Troubleshooting</b> .....	<b>36</b>
<b>695/795 Lo-Boy Standard Parts</b> .....	<b>50</b>
<b>695/795/Mark IV HD Hi-Boy Standard Parts</b> .....	<b>52</b>
<b>1095/1595/Mark V HD/Mark VII HD Hi-Boy Standard Parts</b> .....	<b>54</b>
<b>Mark X HD Standard Parts</b> .....	<b>56</b>
<b>695/795/Mark IV HD ProContractor Parts</b> .....	<b>58</b>
<b>1095/1595/Mark V HD/Mark VII HD ProContractor Parts</b> .....	<b>60</b>
<b>Mark X HD ProContractor Parts</b> .....	<b>62</b>
<b>1095/1595/Mark V HD /Mark VII HD IronMan Parts</b> .....	<b>64</b>
<b>Mark X HD IronMan Parts</b> .....	<b>66</b>
<b>ProContractor QuikReel</b> .....	<b>68</b>
<b>Spray Gun and Hose</b> .....	<b>69</b>
<b>Filter</b> .....	<b>70</b>
<b>Control</b> .....	<b>72</b>
<b>Wiring Diagrams</b> .....	<b>74</b>
<b>Technical Specifications</b> .....	<b>78</b>
<b>Compliance</b> .....	<b>86</b>
Radio Frequency Approvals .....	86
California Proposition 65 .....	86
<b>Graco Standard Warranty</b> .....	<b>87</b>
<b>Graco Information</b> .....	<b>88</b>

## Models

### 695 Models







	Voltage	Model	Standard Lo-Boy	Standard Hi-Boy	ProContractor
	120 NEMA 5-15	Ultra Max II 695	17E572	17E574	17E577
		Ultimate MX II 695	826222	826223	826224
	230 CEE 7/7	Ultra Max II 695		17E632	17E635
	230 Europe Multi	Ultra Max II 695		17E633	17E636
	110 UK	Ultra Max II 695		17E634	17E637
	230 ANZ/KR	Ultra Max II 695	17E610	17E613	17E614
	230 AP	Ultra Max II 695			26C981
	100 Japan/Taiwan	Ultra Max II 695		26C982	26C983

### 795 Models





	Voltage	Model	Standard Lo-Boy	Standard Hi-Boy	ProContractor
	120 NEMA 5-15	Ultra Max II 795		17E579	17E582
		Ultimate MX II 795		826225	826226
	230 CEE 7/7	Ultra Max II 795		17E639	17E642
	230 Europe Multi	Ultra Max II 795		17E640	17E643
	110 UK	Ultra Max II 795		17E641	17E644
	230 ANZ/KR	Ultra Max II 795	17E616	17E617	17E619
	230 AP	Ultra Max II 795			26C984
	100 Japan/Taiwan	Ultra Max II 795		26C985	26C986



## 1095 Models







			Standard Hi-Boy	ProContractor	IronMan
	<b>Voltage</b>	<b>Model</b>			
	120 NEMA 5-15	Ultra Max II 1095	17E583	17E585	17E586
		Ultimate MX II 1095	826227	826228	826229
	230 CEE 7/7	Ultra Max II 1095	17E646	17E647	17E650
	230 Europe Multi	Ultra Max II 1095		17E648	
	230 ANZ/KR	Ultra Max II 1095	17E620	17E621	17E623
	230 AP	Ultra Max II 1095		26C987	
	100 Japan/Taiwan	Ultra Max II 1095	26C988	26C989	

## 1595 Models

			Standard Hi-Boy	ProContractor	IronMan
	<b>Voltage</b>	<b>Model</b>			
	120 NEMA 5-20	Ultimate MX II 1595		826233	
		Ultra Max II 1595		17E593	
	120 NEMA 5-15	Ultra Max II 1595	17E589	17E596	17E594
		Ultimate MX II 1595	826230	826232	826234

# Models

## Mark HD Models

			Standard Hi-Boy	ProContractor	IronMan
	<b>Voltage</b>	<b>Model</b>			
	120 NEMA 5-15	Mark IV HD	17E603	17E604	
	120 NEMA 5-20	Mark V HD		17E628	
	120 NEMA 5-15	Mark V HD	17E605	17E606	17E607
	230 NEMA L6-30	Mark X HD	17E608	17E609	
	230 CEE 7/7	Mark IV HD	17E651	17E653	
		Mark V HD	17E655	17E660	17E664
		Mark VII HD	17E665	17E667	17H895
		Mark X HD	17E669	17E671	17H897
	230 Europe Multi	Mark IV HD	17E652	17E654	
		Mark V HD		17E661	
		Mark VII HD	17E666	17E668	17H896
110 UK	Mark XHD	17E670	17E672	17H898	
	230 ANZ/KR	Mark V HD		17E663	17E629
		Mark VII HD		26C993	
		Mark X HD		17E674	
	230 AP	Mark IV HD	17E624		
		Mark V HD	17E657	26C990	
		Mark VII HD	26C992		
Mark X HD		17E673	26C995		
100 Japan/Taiwan	Mark V HD		26C991		

## Warnings

The following warnings are for the setup, use, grounding, maintenance, and repair of this equipment. The exclamation point symbol alerts you to a general warning and the hazard symbols refer to procedure-specific risks. When these symbols appear in the body of this manual or on warning labels, refer back to these Warnings. Product-specific hazard symbols and warnings not covered in this section may appear throughout the body of this manual where applicable.

### **WARNING**



#### **GROUNDING**

This product must be grounded. In the event of an electrical short circuit, grounding reduces the risk of electric shock by providing an escape wire for the electric current. This product is equipped with a cord having a grounding wire with an appropriate grounding plug. The plug must be plugged into an outlet that is properly installed and grounded in accordance with all local codes and ordinances.

- Improper installation of the grounding plug is able to result in a risk of electric shock.
- When repair or replacement of the cord or plug is required, do not connect the grounding wire to either flat blade terminal.
- The wire with insulation having an outer surface that is green with or without yellow stripes is the grounding wire.
- Check with a qualified electrician or serviceman when the grounding instructions are not completely understood, or when in doubt as to whether the product is properly grounded.
- Do not modify the plug provided; if it does not fit the outlet, have the proper outlet installed by a qualified electrician.
- This product is for use on a nominal 120 V or 230 V circuit and has a grounding plug similar to the plugs illustrated in the figure below.

120V US



230V



230V ANZ



230V India



ti24583c

- Only connect the product to an outlet having the same configuration as the plug.
- Do not use a 3-to-2 adapter with this product.

#### **Extension Cords:**

- Use only a 3-wire extension cord that has a grounding plug and a grounding receptacle that accepts the plug on the product.
- Make sure your extension cord is not damaged. If an extension cord is necessary use 12 AWG (2.5mm<sup>2</sup>) minimum to carry the current that the product draws.
- An undersized cord results in a drop in line voltage and loss of power and overheating.

Conductor Size		Length
AWG (American Wire Gauge)	Metric	Maximum
12	2.5 mm <sup>2</sup>	50 ft. (15 m)

## **WARNING**

### **FIRE AND EXPLOSION HAZARD**



Flammable fumes, such as solvent and paint fumes, in work area can ignite or explode. To help prevent fire and explosion:



- Do not spray flammable or combustible materials near an open flame or sources of ignition such as cigarettes, motors, and electrical equipment.



- Paint or solvent flowing through the equipment is able to result in static electricity. Static electricity creates a risk of fire or explosion in the presence of paint or solvent fumes. All parts of the spray system, including the pump, Hose assembly, Spray Gun, and objects in and around the spray area shall be properly grounded to protect against static discharge and sparks. Use Graco conductive or grounded high-pressure airless paint sprayer hoses.



- Verify that all containers and collection systems are grounded to prevent static discharge. Do not use pail liners unless they are anti-static or conductive.

- Connect to a grounded outlet and use grounded extensions cords. Do not use a 3-to-2 adapter.

- Do not use a paint or a solvent containing halogenated hydrocarbons.

- Do not spray flammable or combustible liquids in a confined area.

- Keep spray area well-ventilated. Keep a good supply of fresh air moving through the area.

- Sprayer generates sparks. Keep pump assembly in a well ventilated area a least 20 feet (6.1 m) from the spray area when spraying, flushing, cleaning, or servicing. Do not spray pump assembly.

- Do not smoke in the spray area or spray where sparks or flame is present.

- Do not operate light switches, engines, or similar spark producing products in the spray area.

- Keep area clean and free of paint or solvent containers, rags, and other flammable materials.

- Know the contents of the paints and solvents being sprayed. Read all Safety Data Sheets (SDSs) and container labels provided with the paints and solvents. Follow the paint and solvents manufacturer's safety instructions.

- Keep a working fire extinguisher in the work area.

### **ELECTRIC SHOCK HAZARD**



This equipment must be grounded. Improper grounding, setup, or usage of the system can cause electric shock.



- Turn off and disconnect power cord before servicing equipment.

- Connect only to grounded electrical outlets.

- Use only 3-wire extension cords.

- Ensure ground prongs are intact on power and extension cords.

- Do not expose to rain. Store indoors.

- Wait five minutes after disconnecting power cord before servicing.

## **WARNING**

### **SKIN INJECTION HAZARD**



High-pressure spray is able to inject toxins into the body and cause serious bodily injury. In the event that injection occurs, **get immediate surgical treatment**.



- Do not aim the Spray Gun at, or spray any person or animal.
- Keep hands and other body parts away from the discharge. For example, do not try to stop leaks with any part of the body.



- Always use the nozzle tip guard. Do not spray without nozzle tip guard in place.



- Use Graco nozzle tips.



- Use caution when cleaning and changing nozzle tips. In the case where the nozzle tip clogs while spraying, follow the **Pressure Relief Procedure** for turning off the unit and relieving the pressure before removing the nozzle tip to clean.

- Equipment maintains pressure after power is shut off. Do not leave the equipment energized or under pressure while unattended. Follow the **Pressure Relief Procedure** when the equipment is unattended or not in use, and before servicing, cleaning, or removing parts.

- Check hoses and parts for signs of damage. Replace any damaged hoses or parts.

- This system is capable of producing 3000 psi (207 bar, 20.7 MPa). Use Graco replacement parts or accessories that are rated a minimum of 3000 psi (207 bar, 20.7 MPa).

- Always engage the Trigger Lock when not spraying. Verify the Trigger Lock is functioning properly.

- Verify that all connections are secure before operating the unit.

- Know how to stop the unit and bleed pressure quickly. Be thoroughly familiar with the controls.

### **EQUIPMENT MISUSE HAZARD**



Misuse can cause death or serious injury.



- Always wear appropriate gloves, eye protection, and a respirator or mask when painting.

- Do not operate or spray near children. Keep children away from equipment at all times.

- Do not overreach or stand on an unstable support. Keep effective footing and balance at all times.

- Stay alert and watch what you are doing.

- Do not operate the unit when fatigued or under the influence of drugs or alcohol.

- Do not kink or over-bend the Hose.

- Do not expose the Hose to temperatures or to pressures in excess of those specified by Graco.

- Do not use the Hose as a strength member to pull or lift the equipment.

- Do not spray with a Hose shorter than 25 feet.

- Do not alter or modify equipment. Alterations or modifications may void agency approvals and create safety hazards.

- Make sure all equipment is rated and approved for the environment in which you are using it.

### **PRESSURIZED ALUMINUM PARTS HAZARD**



Use of fluids that are incompatible with aluminum in pressurized equipment can cause serious chemical reaction and equipment rupture. Failure to follow this warning can result in death, serious injury, or property damage.

- Do not use 1,1,1-trichloroethane, methylene chloride, other halogenated hydrocarbon solvents or fluids containing such solvents.

- Do not use chlorine bleach.

- Many other fluids may contain chemicals that can react with aluminum. Contact your material supplier for compatibility.

# Warnings

## **WARNING**



### **MOVING PARTS HAZARD**

Moving parts can pinch, cut, or amputate fingers and other body parts.

- Keep clear of moving parts.
- Do not operate equipment with protective guards or covers removed.
- Equipment can start without warning. Before checking, moving, or servicing equipment, follow the **Pressure Relief Procedure** and disconnect all power sources.



### **TOXIC FLUID OR FUMES HAZARD**

Toxic fluids or fumes can cause serious injury or death if splashed in the eyes or on skin, inhaled, or swallowed.

- Read Safety Data Sheets (SDSs) to know the specific hazards of the fluids you are using.
- Store hazardous fluid in approved containers, and dispose of it according to applicable guidelines.



### **PERSONAL PROTECTIVE EQUIPMENT**

Wear appropriate protective equipment when in the work area to help prevent serious injury, including eye injury, hearing loss, inhalation of toxic fumes, and burns. This protective equipment includes but is not limited to:

- Protective eyewear, and hearing protection.
- Respirators, protective clothing, and gloves as recommended by the fluid and solvent manufacturer.

## Know Your Sprayer

695 / 795 / 1095 / 1595 / Mark IV HD/ Mark V HD/ Mark VII HD/ Mark X HD Standard Models:

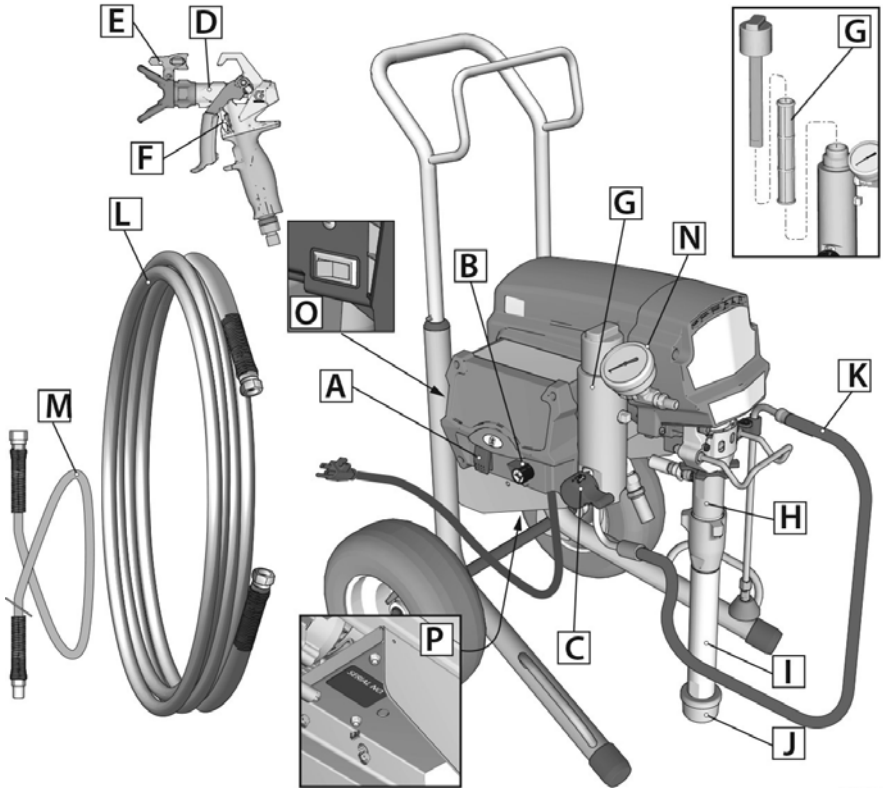

ti34582a

A	ON/OFF Switch
B	Pressure Control Knob
C	Prime / Spray Valve
D	Spray Gun
E	Spray Tip
F	Trigger Lock
G	Filter
H	Pump

I	Suction Tube
J	Inlet Strainer
K	Drain Tube
L	Hose
M	Whip Hose (not included on all models)
N	Pressure Gauge (not included on all units)
O	Amp Switch (not equipped on all units)
P	Unit/Serial Tag

# Know Your Sprayer

695 / 795 / 1095 / 1595 Mark IV HD/ Mark V HD/ Mark VII HD/ Mark X HD ProContractor Models:

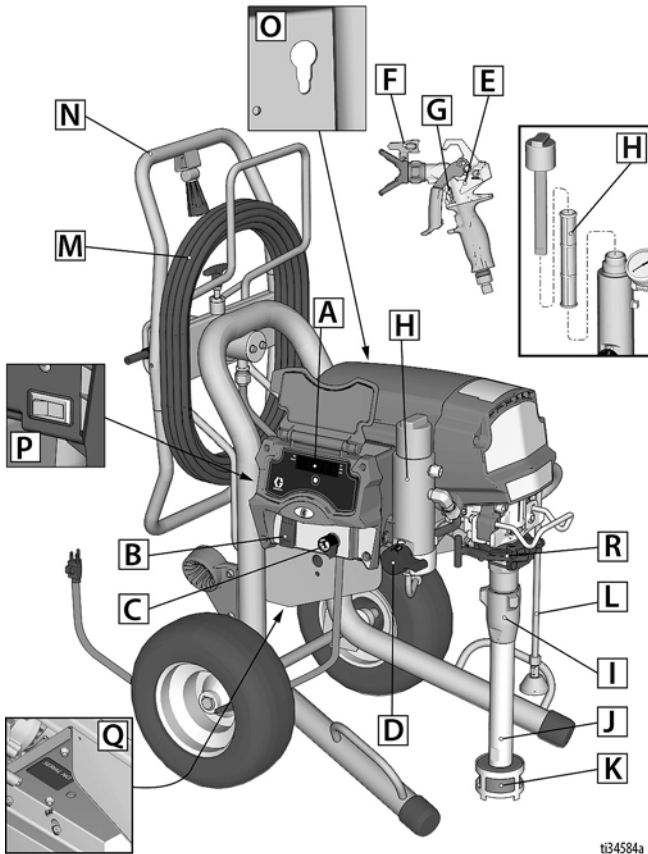

ti34584a

A	LED Display (not included on all units)
B	ON/OFF Switch
C	Pressure Control Knob
D	Prime / Spray Valve
E	Spray Gun
F	Spray Tip
G	Trigger Lock
H	Filter
I	Pump

J	Suction Tube
K	Inlet Strainer
L	Drain Tube
M	Hose
N	QuikReel™
O	ProConnect Pump Rod Pull Feature
P	Amp Switch (not equipped on all units)
Q	Unit/Serial Tag
R	ProConnect II



## 1095 / 1595 / Mark V HD IronMan Models:

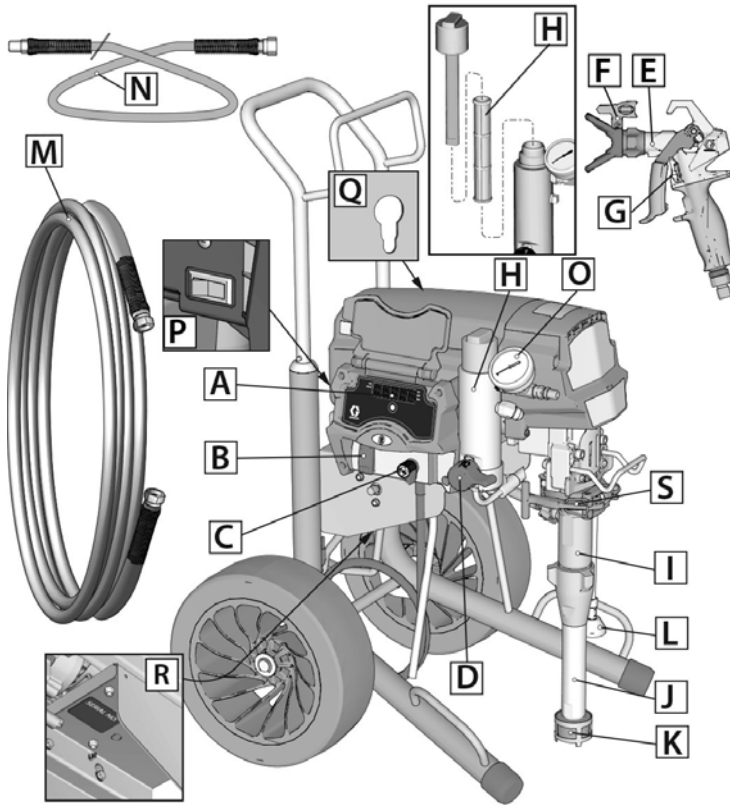

ti34583a

A	LED Display (not included on all units)
B	ON/OFF Switch
C	Pressure Control Knob
D	Prime / Spray Valve
E	Spray Gun
F	Spray Tip
G	Trigger Lock
H	Filter
I	Pump
J	Suction Tube

K	Inlet Strainer
L	Drain Tube
M	Hose
N	Whip Hose (not included on all models)
O	Pressure Gauge (not included on all units)
P	Amp Switch (not equipped on all units)
Q	ProConnect Pump Rod Pull Feature
R	Unit/Serial Tag
S	ProConnect II

## Know Your Controls

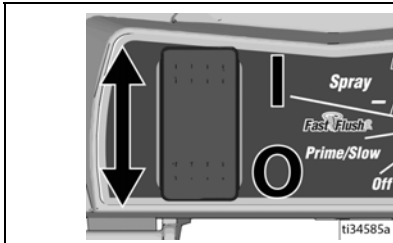

The ON/OFF power switch controls the power to your sprayer.

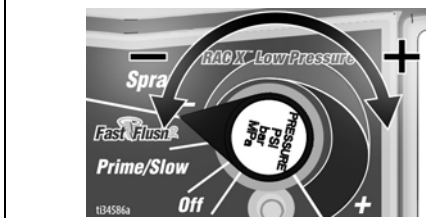

The Pressure Control Knob increases or decreases the pressure. It also has a setting for Prime/Slow and FastFlush™.

### PRIME/SPRAY

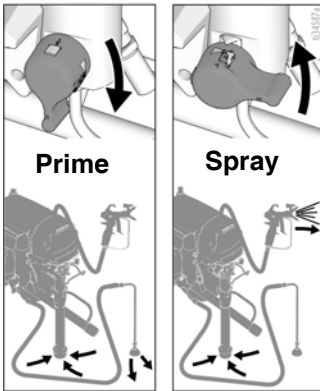

The Prime/Spray Valve directs the fluid to either the Drain Tube or the Hose and Spray Gun. It is used to prime the sprayer, which means to evacuate the air out of the pump, Hose, and Spray Gun.

Your Spray Gun will not spray if there is air in the system. It is necessary to prime the pump, Hose, and Spray Gun any time air enters the Suction Tube.

### SPRAY TIP

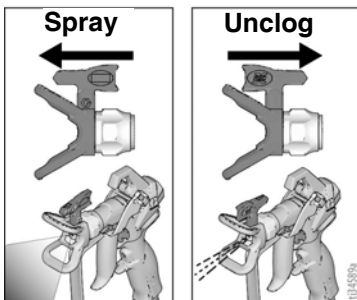

The Spray Tip is the key to airless spray technology. High pressure paint pumped through the very small hole in the Spray Tip comes out as a spray.

The Spray Tip has the ability to be reversed and quickly clear clogs.

# Setup

## Assemble Your Sprayer

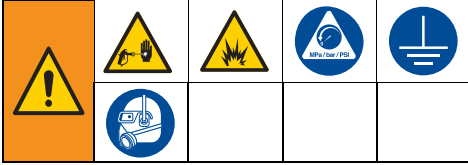

When unpacking sprayer for the first time or after long term storage perform setup procedure.

1. **All sprayers except ProContractor:** Connect Graco airless Hose to sprayer. If whip Hose is included, attach to end of airless Hose. Use wrenches to tighten securely.

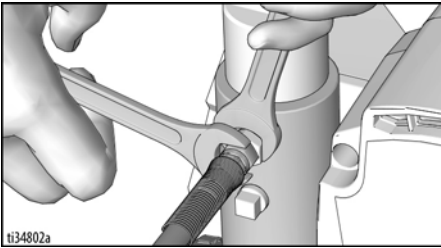

2. Connect Spray Gun to other end of Hose. Use wrenches to tighten securely.

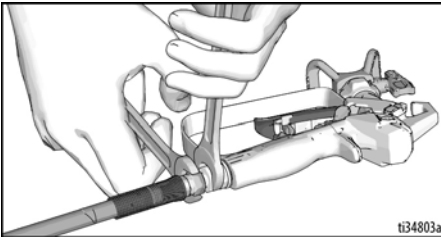

3. When unpacking sprayer for the first time remove packaging materials from inlet strainer. After long term storage check inlet strainer for clogs and debris.



4. Fill throat packing nut with Graco TSL™ to prevent premature packing wear. Do this each time you spray.
  - a. Place the TSL bottle nozzle into the top center opening in the grill at the front of the sprayer.
  - b. Squeeze bottle to dispense enough TSL to fill the space between the pump rod and packing nut seal.

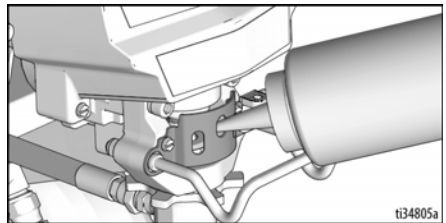

5. Ensure Spray Tip is properly inserted into the Spray Tip Guard, and the Spray Tip Guard assembly is tightened securely to the Spray Gun. Refer to separate Spray Gun manual.
6. Perform the **Pressure Relief Procedure**, page 18.

## QuikReel™

(ProContractor models only)



Moving parts can pinch, cut or amputate fingers and other body parts. To avoid injury from moving parts, be sure to keep your head clear of QuikReel while winding up Hose.

1. Make sure Hose is routed through hose guide.

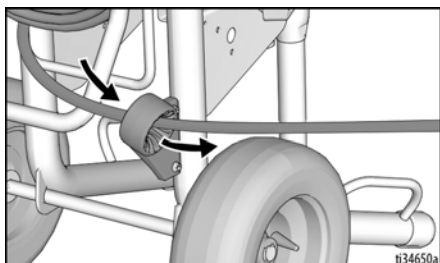

2. Lift and turn pivot lock 90° to unlock Hose Reel. Pull on Hose to remove it from Hose Reel.

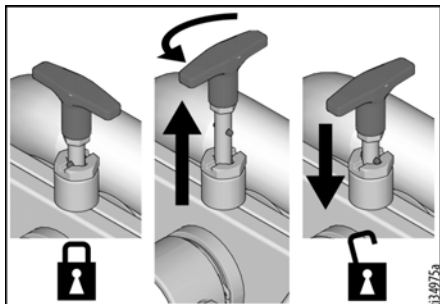

3. Pull reel handle down and out. Turn clockwise to reel in Hose.

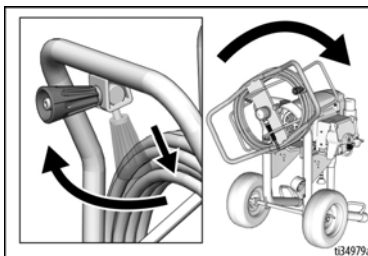

**NOTE:** QuikReel can be locked into two positions: Usage (A) and Storage (B).

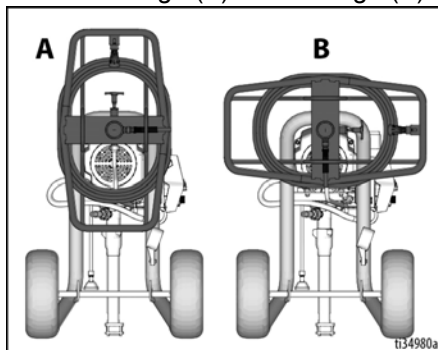

## Grounding



The equipment must be grounded to reduce the risk of static sparking and electric shock. An electric or static spark can cause fumes to ignite or explode. An improper ground can cause electric shock. A good ground provides an escape wire for the electric current.

This sprayer is equipped with a power cord that has a ground wire and an appropriate grounding plug.

The plug must be plugged into an outlet that is properly installed and grounded in accordance with all local codes and ordinances.

Do not modify the plug provided; if it does not fit the outlet, have the proper outlet installed by a qualified electrician.

## Power Requirements

- 100-120V units require 100-120 VAC, 50/60 Hz, 15A, 1 phase.
- 230V units require 230 VAC, 50/60 HZ, 10A-16A, 1 phase.

## Extension Cords

Use an extension cord with an undamaged ground contact. If an extension cord is necessary, use a 3-wire, 12 AWG (2.5 mm<sup>2</sup>) minimum.

**NOTE:** Smaller gauge or longer extension cords may reduce sprayer performance.

## Pails

**Solvent and oil-based fluids:** follow local code. Use only conductive metal pails, placed on a grounded surface such as concrete.

Do not place pail on a non-conductive surface such as paper or cardboard which interrupts grounding continuity.

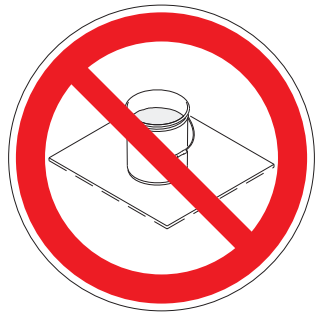

**Always ground a metal pail:** connect a ground wire to the pail. Clamp one end to the pail and the other end to a true earth ground such as a water pipe.

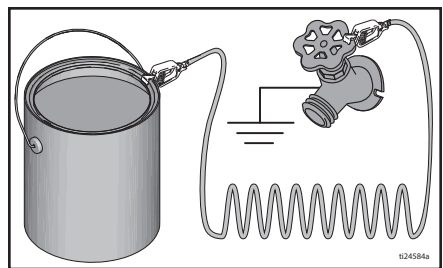

## Start Up

### Pressure Relief Procedure



Follow the Pressure Relief Procedure whenever you see this symbol.

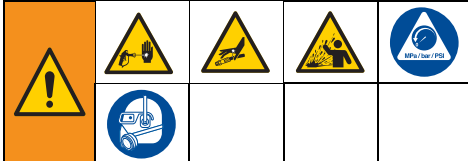

This equipment stays pressurized until pressure is manually relieved. To help prevent serious injury from pressurized fluid, such as skin injection or splashed fluid, follow the **Pressure Relief Procedure** whenever sprayer is stopped and before sprayer is cleaned or checked, and before equipment is serviced.

1. Turn ON/OFF switch to the **OFF** position.

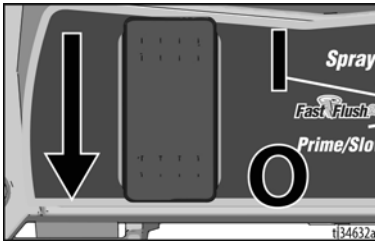

2. Engage the Trigger Lock. Always engage the Trigger Lock when sprayer is stopped to prevent the Spray Gun from being triggered accidentally.



3. Turn Pressure Control Knob to **OFF** (all the way counterclockwise).



4. Put Drain Tube into a waste pail and turn Prime/Spray Valve down to **PRIME** position to relieve pressure.

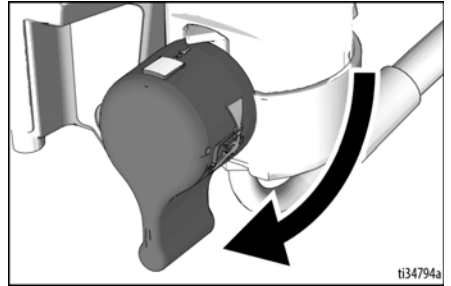

5. Hold the Spray Gun firmly to a grounded pail. Point Spray Gun into pail. Disengage the Trigger Lock and trigger the Spray Gun to relieve pressure.

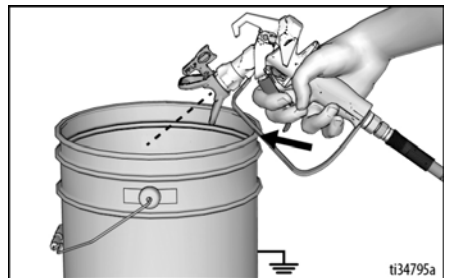

6. Engage the Trigger Lock.



7. If you suspect the spray tip or Hose is clogged or that pressure has not been fully relieved:
  - a. **VERY SLOWLY** loosen the tip guard retaining nut or the Hose end coupling to relieve pressure gradually.
  - b. Loosen the nut or coupling completely.
  - c. Clear Hose or tip obstruction.

**NOTE:** Leave Prime/Spray Valve in the PRIME position until you are ready to spray.

## 10/16 Amp Switch

(230V Mark VII and Mark X units)

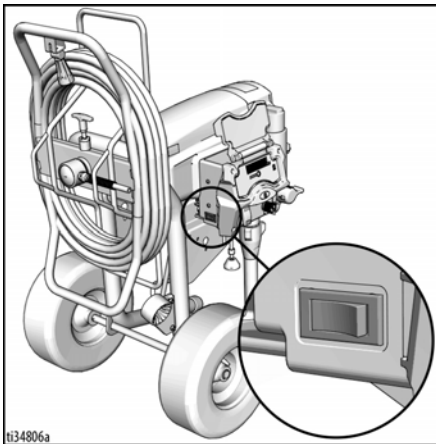

Use 16A setting if 16A circuit is available for maximum sprayer performance. Otherwise, use 10A setting.

## 15/20 Amp Switch

(120V 1595 and Mark V units)

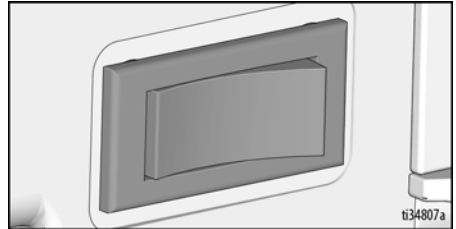

Use 20A setting if 20A circuit is available for maximum sprayer performance. Otherwise, use 15A setting.

## Flush Storage Fluid

**It is important that you flush storage fluid from the sprayer before using it.**

1. Make certain ON/OFF switch is **OFF**.
2. Separate Drain Tube (smaller) from Suction Tube (larger). Place Drain Tube in a waste pail.
3. Submerge Suction Tube into grounded pail filled with appropriate flushing fluid.

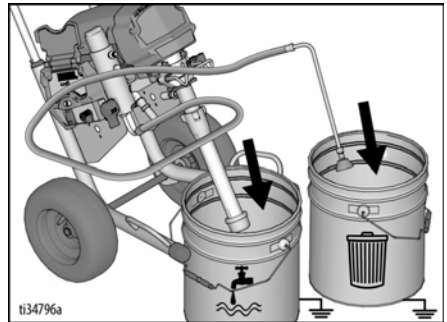

# Start Up

4. Make certain Prime/Spray Valve is down in the **PRIME** position.

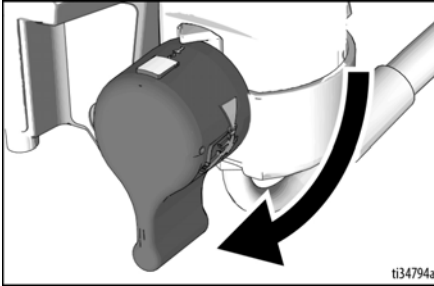

5. Make certain the Pressure Control Knob is set to **OFF** (all the way counterclockwise).

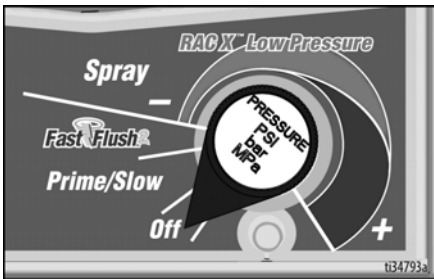

6. Plug power cord into a properly grounded electrical outlet.
7. Turn ON/OFF switch to **ON** position.
8. Turn Pressure Control Knob to Prime/Slow in order to start the motor. Flushing fluid will flow up the Suction Tube and out the Drain Tube into the waste pail.



9. When you see flushing fluid exiting the Drain Tube, turn Pressure Control Knob to FastFlush setting and allow unit to flush for 30-60 seconds.

10. Turn the ON/OFF switch to **OFF** position.

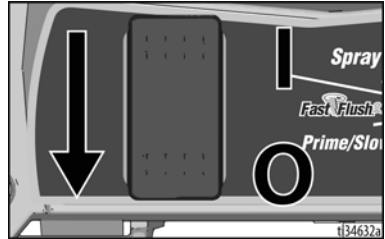

## Strain the Paint

Disposable paint strainer bags are used to remove coarse particles and debris from new or previously opened paint or stain, and are available where paint is sold. To avoid priming problems and Spray Tip clogs it is recommended to strain all paints and stains before spraying. Stretch a disposable paint strainer bag over a clean pail and pour the paint through the strainer.



				
<p>High-pressure spray is able to inject toxins into the body and cause serious bodily injury. Do not stop leaks with hand or rag.</p>				



## Fill Pump (Prime Pump)

The Prime/Spray Valve directs the fluid to either the Drain Tube or the Hose and Spray Gun. It is used to prime the sprayer, which means to evacuate the air out of the pump, Hose, and Spray Gun.

Your Spray Gun will not spray if there is air in the system. It is necessary to prime the pump, Hose, and Spray Gun any time air enters the Suction Tube.

1. Move Suction Tube to paint pail and submerge Suction Tube in paint. Place Drain Tube in waste pail.

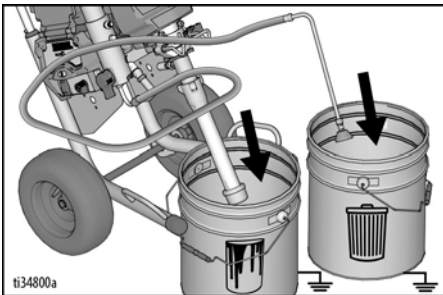

2. Turn Pressure Control Knob to Prime/Slow.
3. Turn ON/OFF switch to **ON** position to start motor.
4. Wait to see paint coming out of Drain Tube.
5. Turn Pressure Control Knob to **OFF** (all the way counterclockwise) to disengage motor.

## Fill Spray Gun and Hose

1. Remove Spray Tip Guard.

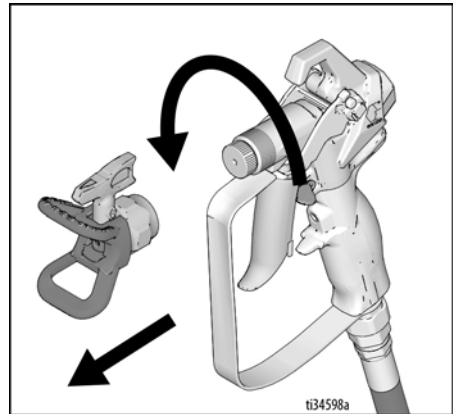

2. Hold Spray Gun against waste pail. Point Spray Gun into waste pail.

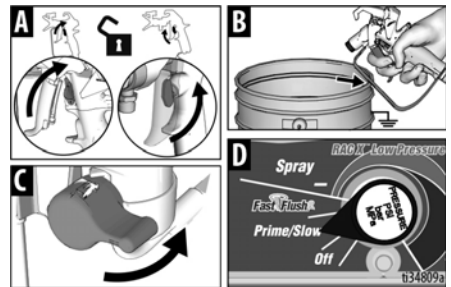

- a. Disengage Trigger Lock (A).
- b. Pull and hold Spray Gun trigger (B).
- c. Turn Prime/Spray Valve horizontal to **SPRAY** position (C).
- d. Turn Pressure Control Knob to Prime/Slow (D).

# Start Up

- Continue to trigger Spray Gun into waste pail until only paint comes out of the Spray Gun.
- Release trigger. Engage Trigger Lock.



High-pressure spray is able to inject toxins into the body and cause serious bodily injury. Do not stop leaks with hand or rag.				

**NOTE:** Inspect for leaks. If leaking occurs, perform **Pressure Relief Procedure**, page 18, then tighten all fittings and repeat **Fill Pump (Prime Pump)**, page 21.

- Transfer Drain Tube to paint pail.

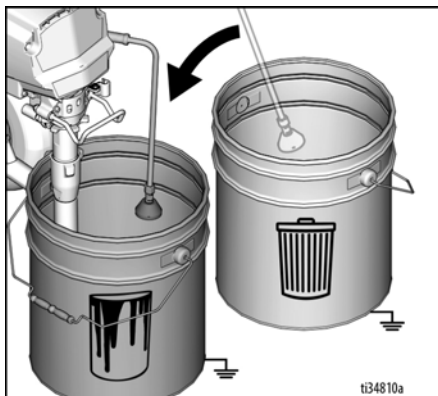

- Install Spray Tip Guard. Rotate Spray Tip back to SPRAY position and ensure the Spray Tip Guard is tight.

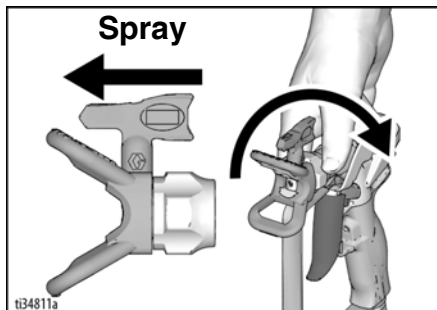

**You are now ready to spray!**

**NOTE:** It is normal for the motor to stop once the sprayer is primed and under pressure.

## Refilling Paint Pail

When the paint pail runs low and the Spray Gun stops spraying, refill the paint pail and repeat the **Fill Pump (Prime Pump)** procedure, then the **Fill Spray Gun and Hose** procedure.

## Spraying

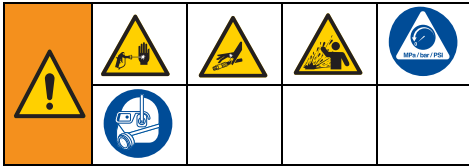

### Start

1. Turn pressure control knob to **SPRAY** position.

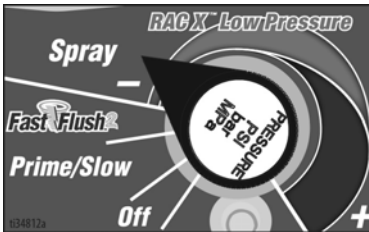

2. Disengage Trigger Lock.



### Adjust Pressure Control

1. For best spray results with lowest overspray, begin with the Pressure Control Knob adjusted to the lowest spray setting.
2. If needed, increase Pressure Control Knob setting to the lowest spray setting that results in an acceptable spray pattern.

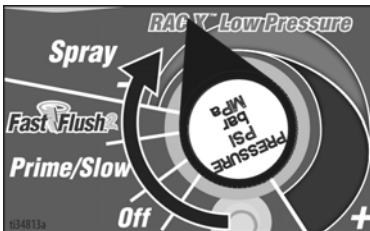

### Spray Pattern Quality

A good spray pattern is evenly distributed as it hits the surface.

- Spray should be atomized (evenly distributed, no gaps at edges).
- Increase Pressure Control Knob if needed until spray is even and without gaps at edges.
- Spray Tip may be worn or a smaller tip may be needed.
- Material may need to be thinned. If material needs to be thinned follow manufacturer's recommendations.

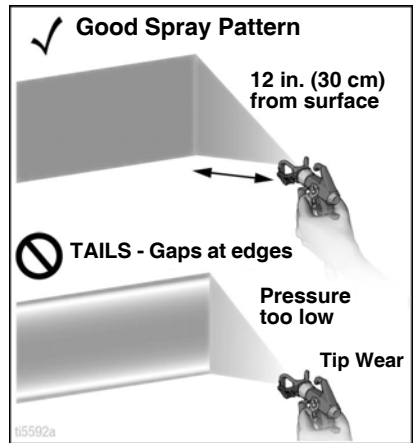

## Spray Techniques

Use a piece of scrap cardboard to practice these basic spraying techniques before you begin spraying the surface.

- Hold Spray Gun 12 in. (30 cm) from surface and aim straight at surface. Tilting Spray Gun to direct spray angle causes an uneven finish.
- Flex wrist to keep Spray Gun pointed straight. Fanning Spray Gun to direct spray at angle causes uneven finish.

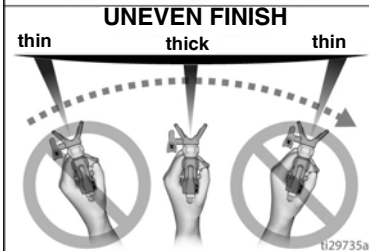
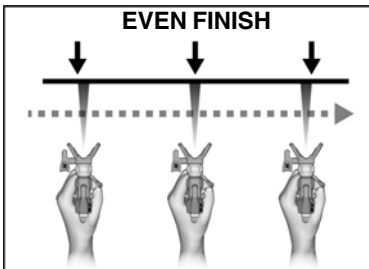
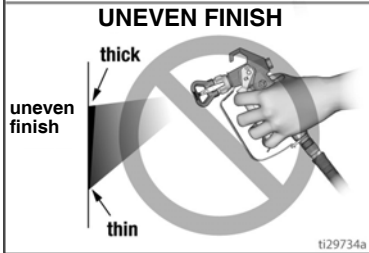
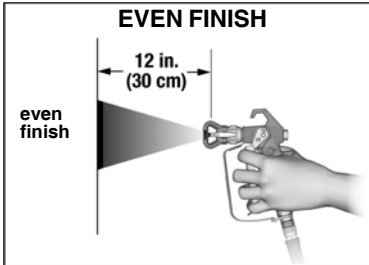

## Triggering Spray Gun

Pull trigger after starting stroke. Release trigger before end of stroke. Spray Gun must be moving when trigger is pulled and released.

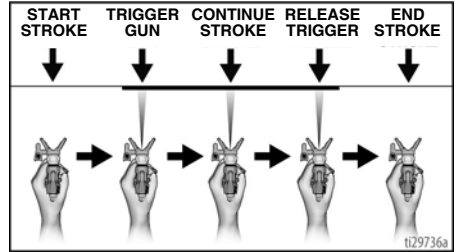

## Aiming Spray Gun

Aim center of spray of Spray Gun at bottom edge of previous stroke, overlapping each stroke by half.

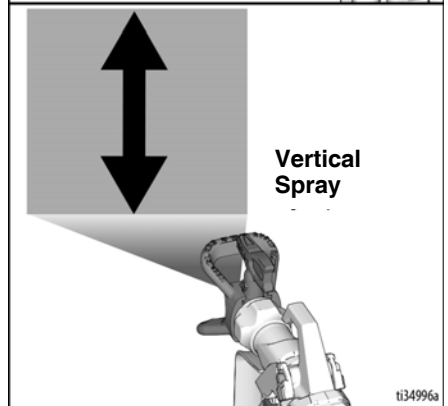
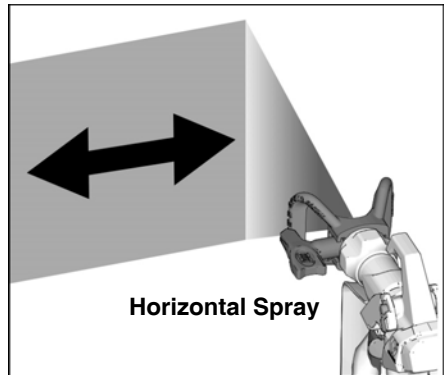

## Clear Spray Tip Clog

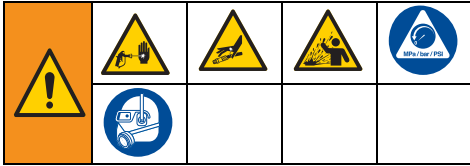

In the event that particles or debris clog the Spray Tip, the Spray Tip can be reversed to quickly and easily clear particles without disassembling the sprayer.

See **Strain the Paint**, page 20, for additional information.

1. Engage Trigger Lock. Rotate Spray Tip to UNCLOG position. Ensure spray tip remains fully seated, pushed all the way into the Spray Tip Guard. Disengage Trigger Lock. Trigger Spray Gun at waste area to clear clog.

### UNCLOG



**NOTE:** If Spray Tip is difficult to rotate when turning to the UNCLOG position perform, **Pressure Relief Procedure**, page 18, then turn Prime/Spray Valve horizontal to SPRAY position and repeat step 1.

2. Engage Trigger Lock. Rotate Spray Tip back to SPRAY position. Disengage Trigger Lock and continue spraying.

### SPRAY

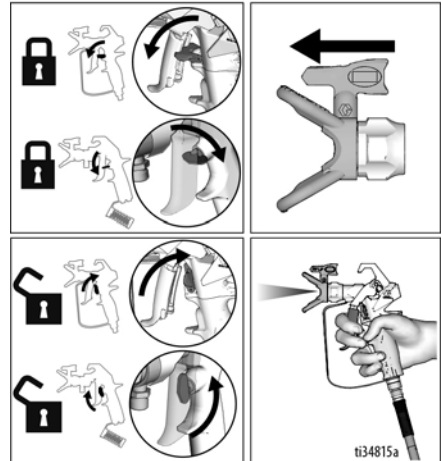

## Spray Tip Installation



To avoid serious injury from skin injection do not put your hand in front of the spray tip when installing or removing the spray tip and spray tip guard.

To prevent Spray Tip leaks make certain Spray Tip and Spray Tip Guard are installed properly. Refer to separate Spray Gun manual for procedure to remove and install Spray Tip, Seal, and Spray Tip Guard.

## Cleanup

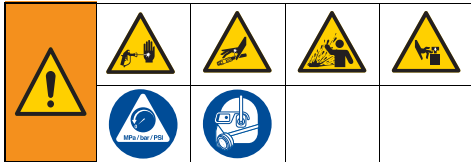

1. Perform **Pressure Relief Procedure**, page 18.
2. Remove Spray Tip Guard and Spray Tip. For additional information, see separate Spray Gun manual.

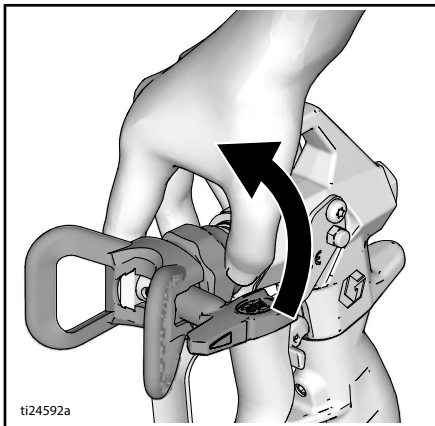

## Clean Drain Tube

3. Remove Suction Tube and Drain Tube from paint; wipe excess paint off outside of Suction Tube.



4. Place Suction Tube in appropriate flushing fluid. Place Drain Tube in waste pail.

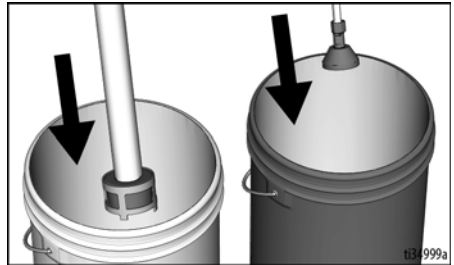

5. To flush Drain Tube and pump turn Prime/Spray Valve down to PRIME position.



6. Turn pressure control to Prime/Slow and turn ON/OFF switch to **ON** position to start the motor. Flushing fluid will flow up the Suction Tube and out the Drain Tube into the waste pail. Allow flushing fluid to flow out of Drain Tube for 5 seconds.

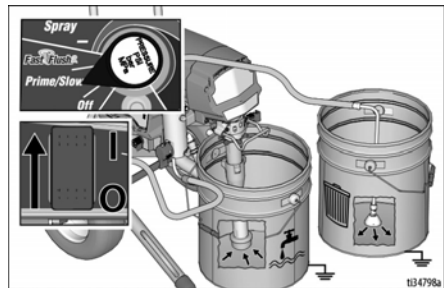

7. Turn Pressure Control Knob to OFF setting (all the way counterclockwise).

## Clean Hose and Spray Gun

8. Hold Spray Gun against a grounded metal waste pail. Point Spray Gun into waste pail.
  - a. Disengage Trigger Lock (A).
  - b. Pull and hold Spray Gun trigger (B).
  - c. Turn Prime/Spray Valve horizontal to SPRAY position (C).
  - d. Turn pressure control to 12 o' clock position to begin flushing (D). (For optimal cleaning performance, the Pressure Control Knob can be turned to the FastFlush setting.)

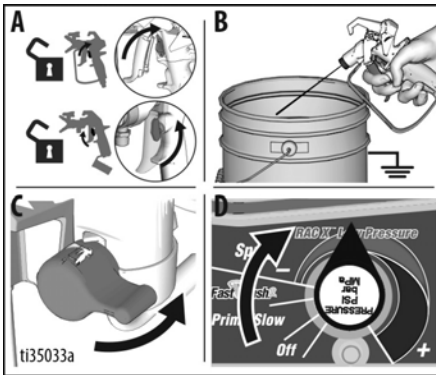

9. Continue flushing until flushing fluid appears clear.
10. Turn Pressure Control Knob to OFF (all the way counterclockwise).
11. Stop triggering Spray Gun.

12. Remove Suction Tube from flushing fluid so that air can enter the pump and push flushing fluid out of the Hose and Spray Gun.

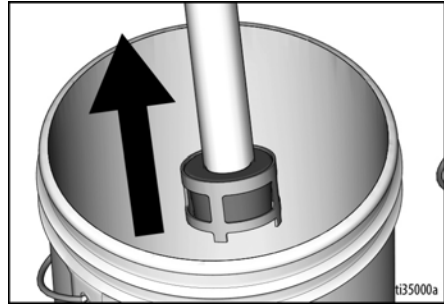

13. Trigger Spray Gun into flushing pail and turn Pressure Control Knob to 12 o' clock position to purge fluid from Hose.
14. When flushing fluid has been purged, release trigger. Engage Trigger Lock.

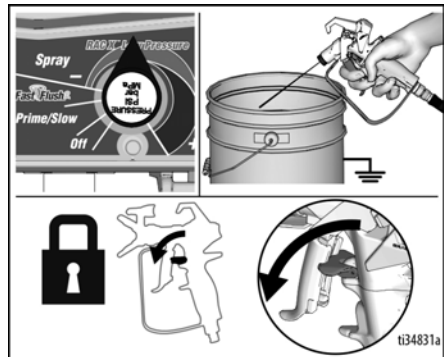

# Cleanup

15. Turn Pressure Control Knob to OFF and turn ON/OFF switch to **OFF** position. Disconnect power to sprayer.

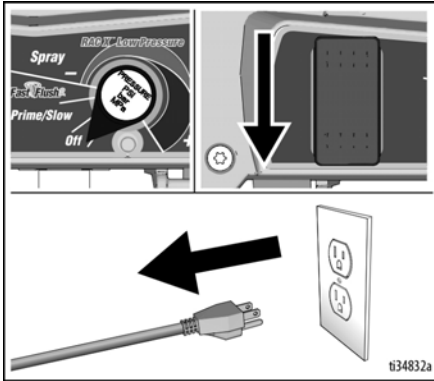

16. Turn Prime/Spray Valve down to PRIME position.
17. Remove Spray Tip and Spray Tip Guard from Spray Gun. Remove filter from Spray Gun. Clean and inspect. Reinstall. See separate Spray Gun manual for more information.
18. Remove filter from sprayer. Clean and inspect. Reinstall.

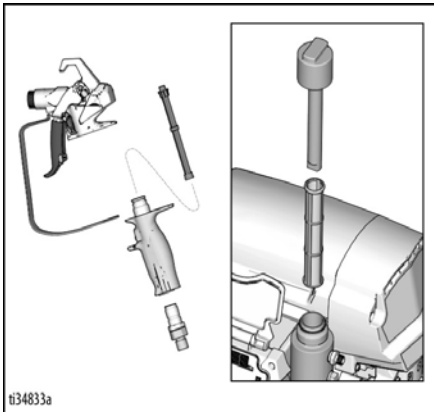

**NOTE:** If flushing with water, flush again with mineral spirits or Pump Armor™ to leave a protective coating to prevent freezing or corrosion for longterm storage.

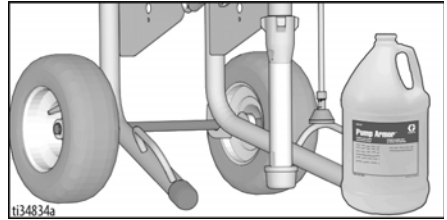

19. Wipe sprayer, Hose and Spray Gun with a rag soaked in water or mineral spirits.

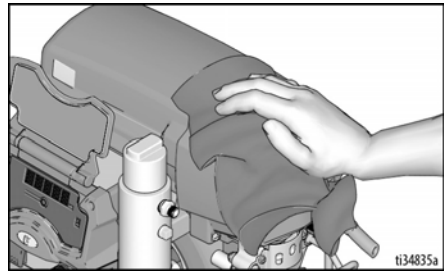



# WatchDog

Your sprayer is equipped with WatchDog™, which automatically stops and protects the pump when the sprayer runs out of paint.

## Enabling or Disabling WatchDog

By default, WatchDog is disabled. To enable or disable WatchDog, use the Graco BlueLink™ app. See page 30 for instructions to download the Graco BlueLink app.

Alternatively, you can enable or disable WatchDog using the LED Display (if equipped). See page 34 for instructions to enable or disable WatchDog using the LED Display.

## Adjusting WatchDog Sensitivity

WatchDog can be set to LOW, MEDIUM, or HIGH sensitivity when detecting if the sprayer has run out of paint. By default, WatchDog sensitivity is set to MEDIUM. WatchDog sensitivity can be adjusted using the Graco BlueLink app or by using the LED Display, as described above.

## Refilling Paint and Resuming

When you run out of paint and WatchDog stops the pump, perform the following steps to resume spraying.

1. Turn the ON/OFF switch to the **OFF** position.
2. Perform **Pressure Relief Procedure**, page 18.
3. Refill the paint pail.
4. Perform the **Fill Pump (Prime Pump)**, page 21, then the **Fill Spray Gun and Hose**, page 21.

## BlueLink™ App

Download the Graco BlueLink app from the Apple App Store, Google Play, or other available application stores to connect to the paint sprayer via Bluetooth®.

The BlueLink app allows you to access sprayer information, settings, statistics, and provides access to useful features such as WatchDog™, improved maintenance tracking, sprayer tracking, and job tracking. Find the Graco BlueLink App at:

<https://www.graco.com/BlueLink>



Further instructions can be accessed within the app. Instructions can also be accessed online at:

<https://www.graco.com/BlueLinkSupport>

## Enabling or Disabling BlueLink



The Graco BlueLink system uses Bluetooth to communicate between the sprayer's control board and a mobile phone. To disable BlueLink by shutting off the Bluetooth transmitter, perform the following steps.

1. Turn the ON/OFF switch to the **OFF** position. Turn the Pressure Control Knob all the way counterclockwise to the OFF position.
2. Unplug sprayer from power outlet and allow power to dissipate for 5 minutes.
3. Remove control box cover.
4. Locate the Bluetooth transmitter power switch (S2) on the control board. Using a ballpoint pen, **DISABLE** BlueLink by moving the switch to the left, or **ENABLE** BlueLink by moving the switch to the right.

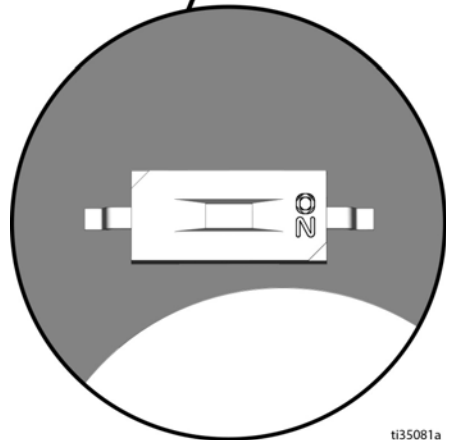
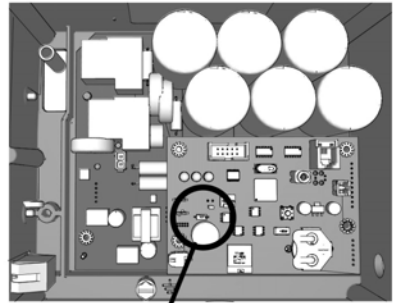

ti35081a

5. Reassemble control box cover.

## Replacing BlueLink Battery

In order to keep your sprayer synced, your unit has a small battery built-in. If you receive the following message, the battery will need to be replaced.

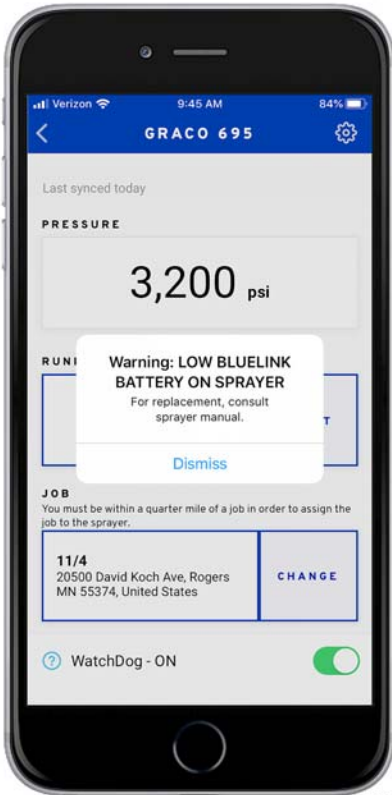

i37542a

1. Turn sprayer OFF and disconnect power.
2. Remove the control box cover.

3. Remove black battery cover with a philips screwdriver.

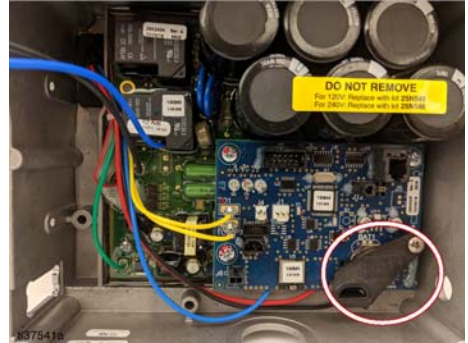

4. Slide battery out of the holder, to the left.
  5. Replace battery with a new CR2032 battery.
  6. Place the battery cover back on the unit.
  7. Hook the clip under the control board.
- NOTE:** The cover should not move.
8. Tighten the screw back into place on the battery cover.

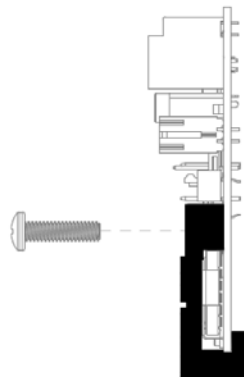

9. Close and screw the control box cover back on the unit.

## LED Display

(not included on all models)

### Operation Main Menu

Short press **DISPLAY** button to move to next display. Press and hold to change units or reset data.

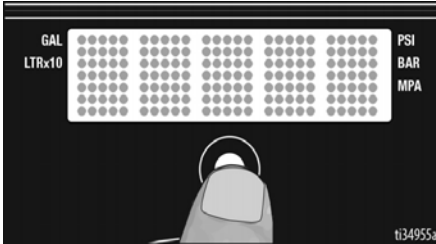

1. Perform the **Pressure Relief Procedure**, page 18.
2. Turn power ON. LED Display will show dashes if pressure is less than 200 psi (14 bar, 1.4 MPa).

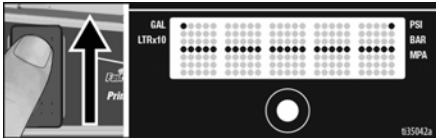

### Change Display Units

Press and hold the **DISPLAY** button for 5 seconds to change pressure units (**psi, bar, MPa**) to desired units. Selection of bar or MPa changes **gallons to liters x 10**. To change display units LED Display must be in pressure display mode and pressure must be at zero (dashes displayed).

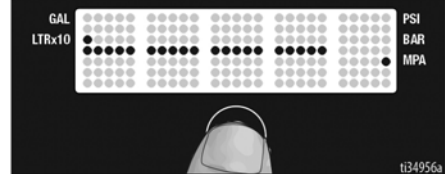
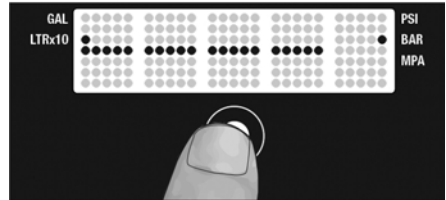
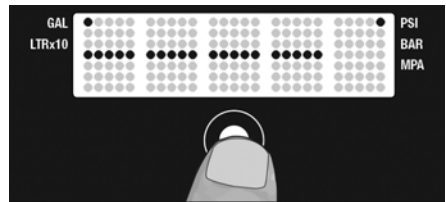

## Job Gallons

1. Short press **DISPLAY** button to move to Job Gallons (or liters x 10).

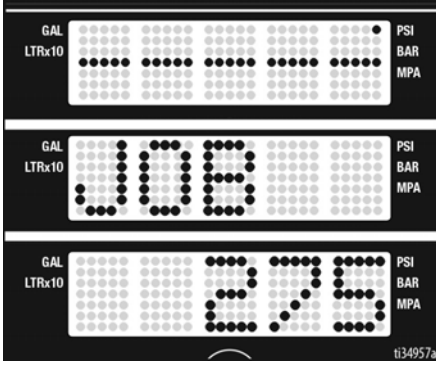

2. Press and hold the **DISPLAY** button to reset to zero.

## Lifetime Gallons

1. Short press **DISPLAY** button to move to Lifetime Gallons (or liters x 10).

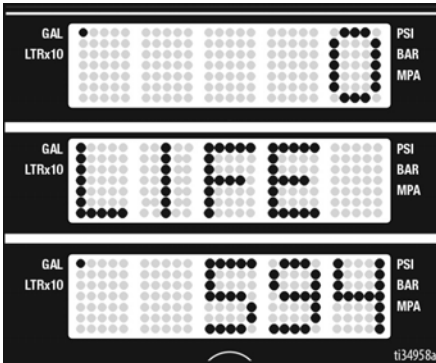

## Secondary Menu - Stored Data

1. Perform **Pressure Relief Procedure**, page 18, steps 1 - 4 if they have not already been done.

2. Turn power switch on while holding **DISPLAY** button down.

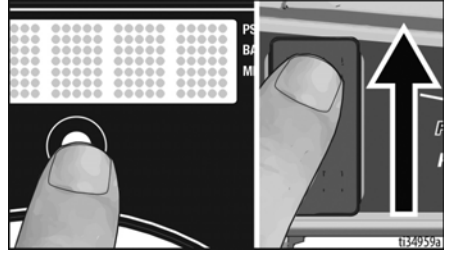

3. **SERIAL NUMBER** scrolls past on the display.

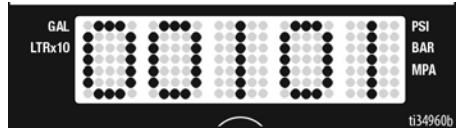

4. Short press **DISPLAY** button to move to **MOTOR HOURS**. The total motor run hours are displayed.

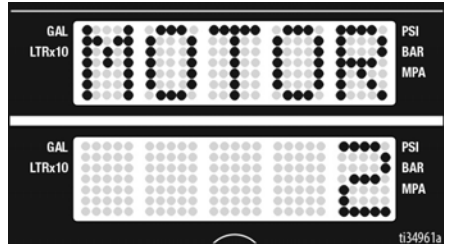

5. Short press **DISPLAY** button. **LAST CODE** scrolls by and last code is displayed; e.g. **CODE 06 MOTOR THERMAL PROTECTION ENABLED** (see Repair manual).

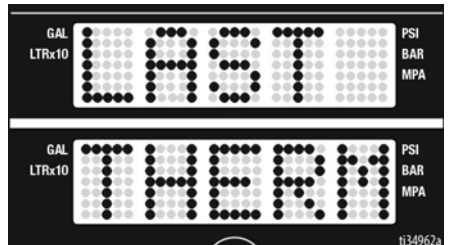

# LED Display

6. Press and hold **DISPLAY** button to clear code. **NO CODE STORED** will be displayed after clearing the code

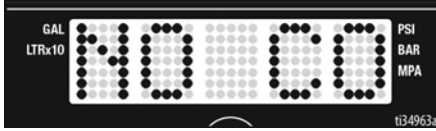

7. Short press **DISPLAY** button. **W-DOG** is displayed then **OFF** displays if watchdog is OFF. **ON** displays if Watchdog is ON.

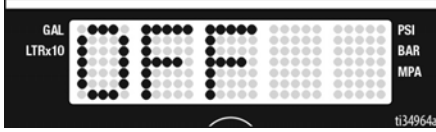
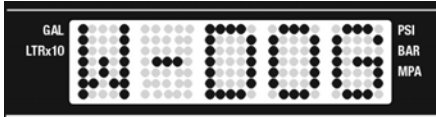

8. Short press **DISPLAY** button to move to WatchDog sensitivity menu. Press and hold **DISPLAY** button and Watchdog can be set to low, medium, or high sensitivity. Release **DISPLAY** button when desired sensitivity setting is displayed. Default is medium.

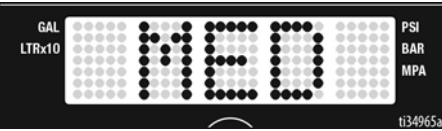

9. Short press **DISPLAY** button to move to **SOFTWARE REV.**
10. Short press **DISPLAY** button. **MOTOR ID RESISTOR** scrolls by and model code number (see below).

Motor ID Number	Models
0	695/230V Mark IV
2	795 / 120V Mark IV
4	1095 / 230V Mark V
6	1595 / 120V Mark V / Mark VII
10	Mark X

11. Short press **DISPLAY** button to move to Pressure Control Knob Calibration. **KNOB** displays. If you wish to calibrate the Pressure Control Knob, follow the procedure below. Otherwise, short press the **DISPLAY** button to return to **SERIAL NUMBER**.



- a. Align the Pressure Control Knob to the line between Fast Flush and the minus (-) symbol.

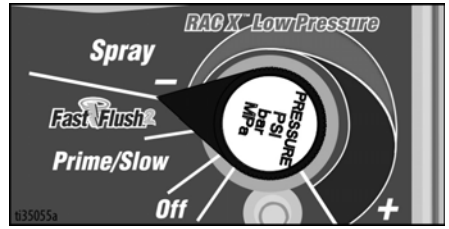

- b. Press and hold **DISPLAY** button to calibrate the Pressure Control Knob. **PASS** is displayed if the knob is aligned correctly, then the menu returns to **SERIAL NUMBER**. Knob calibration is complete.



**NOTE:** If the knob is not aligned correctly, **FAIL** displays, then **KNOB** displays again. Ensure the Pressure Control Knob is aligned correctly, then try the calibration procedure again.

## Maintenance

Routine maintenance is important to ensure proper operation of your sprayer. Maintenance includes performing routine actions which keep your sprayer in operation and prevents trouble in the future.



Perform **Pressure Relief Procedure**, page 18, before performing maintenance.

Activity	Interval
Inspect/clean sprayer filter, fluid inlet strainer, and Spray Gun filter.	Daily or each time you spray
Inspect motor shield vents for blockage.	Daily or each time you spray
Fill TSL by adding through TSL fill point.	Daily or each time you spray
Check sprayer stall. With sprayer Spray Gun NOT triggered, sprayer motor should stall and not restart until Spray Gun is triggered again. If sprayer starts again with Spray Gun NOT triggered, inspect pump for internal/external leaks and check prime valve for leaks.	Every 1000 gallons (3785 liters)
Throat packing adjustment When pump packing begins to leak after extended use, tighten packing nut down until leakage stops or lessens. This allows approximately 100 gallons of additional operation before a repacking is required. Packing nut can be tightened without O-ring removal.	As necessary based on usage



Maintenance can be scheduled and tracked via the Graco BlueLink app. See **Maintenance**, page 35, for more information.

## Recycling and Disposal at End of Life

At the end of the product's useful life, dismantle and recycle it in a responsible manner.

### Preparation:

- Perform the **Pressure Relief Procedure**, page 18.
- Drain and dispose of fluids according to applicable regulations. Refer to the material manufacturer's Safety Data Sheet.

### Dismantle and recycle:

- Remove motors, circuit boards, displays, and other electronic components. Remove the coin-cell battery from the battery holder on the control board. Recycle according to applicable regulations.
- Do not dispose of electronic components with household or commercial waste.
- Deliver remaining product to a recycling facility.

## Troubleshooting



### Mechanical/Fluid Flow





1. Perform **Pressure Relief Procedure**, page 18, before checking or repairing.
2. Solutions listed at the beginning of each problem are the most common.

Problem	Cause	Solution
Paint does not come out of the Spray Gun or you suspect pressure has not been fully relieved.	There is a blockage in the pump Hose or Spray Gun.	<ol style="list-style-type: none"> <li>1. <b>VERY SLOWLY</b> loosen the Hose connection to the Spray Gun and disconnect the airless spray Hose from the Spray Gun.</li> <li>2. Turn Prime/Spray Valve horizontal to <b>SPRAY</b> position.</li> <li>3. While holding Hose firmly, point end of Hose into paint pail. Turn ON/OFF switch to <b>ON</b> position and turn Pressure Control Knob to <b>PRIME/SLOW</b>.               <ol style="list-style-type: none"> <li>a. If fluid does not flow out of Hose, replace the Hose and continue to step 4.</li> <li>b. If fluid flows out of Hose, see Clean the Spray Gun and Spray Gun Filter, page 31.</li> </ol> </li> <li>4. Reassemble the Hose and Spray Gun, and repeat <b>Fill Spray Gun and Hose</b>, page 21.</li> </ol>
Pump output is low	Spray tip worn	Follow <b>Pressure Relief Procedure</b> , page 18, then replace tip. See your separate Spray Gun or tip manual.
	Spray tip clogged	Refer to <b>Clear Spray Tip Clog</b> , page 25.
	Paint supply is empty	Refill and reprime pump.
	Suction Tube strainer clogged	Remove and clean, then reinstall.
	Intake valve ball and piston ball are not seating properly	Remove intake valve and clean. Inspect balls and seats for nicks; replace if necessary; see pump manual. Strain paint before using to remove particles that could clog pump.
	Sprayer filter or Spray Gun filter is clogged or dirty.	Clean or replace filter.
	Prime valve leaking	Follow <b>Pressure Relief Procedure</b> , page 18. Replace prime valve.
	Pump is worn.	Service pump; see pump manual.



Problem	Cause	Solution
Pump output is low (continued)	Pump throat packings are worn.	Tighten packing nut/wet cup. If leakage continues, replace packings; see pump manual. Also check piston valve seat for hardened paint or nicks and replace if necessary. Tighten packing nut/wet-cup.
	Intake valve ball is packed with material	Clean intake valve; see pump manual.
	Pressure setting is too low	Turn Pressure Control Knob clockwise to increase pressure.
	Material is too thick for a small diameter Hose, or Hose is too long.	Use larger diameter Hose and/or reduce overall length of Hose.
	Amp switch is on low setting. (10A or 15A setting)	Switch to 16A or 20A setting.
Fluid is spitting from Spray Gun	Tip is partially clogged	Refer to <b>Clear Spray Tip Clog</b> , page 25.
	Material supply low, or air was not properly purged during priming.	Refill fluid supply. Refer to <b>Fill Pump (Prime Pump)</b> , page 21. Then <b>Fill Spray Gun and Hose</b> , page 21. Check fluid supply often to prevent running pump dry.
Pump is difficult to prime	Intake valve is stuck to seat.	Remove foot valve. Clean and inspect intake valve.
	Suction tube o-ring on foot valve is damaged or missing.	Replace Suction Tube o-ring.
	Air in pump	Refer to <b>Fill Pump (Prime Pump)</b> , page 21. Then <b>Fill Spray Gun and Hose</b> , page 21.
	Intake valve is leaking	Clean intake valve. Be sure ball seat is not nicked or worn and that ball seats well. Reassemble valve.
	Pump packings are worn	Replace pump packings; see pump manual.
Motor does not run	Pressure Control Knob is set too low	Increase pressure by turning Pressure Control Knob clockwise.
	Spray tip clogged	Refer to <b>Clear Spray Tip Clog</b> , page 25.
Motor runs but pump does not stroke	Displacement pump pin damaged or missing; see pump manual.	Replace pump pin if missing. Be sure retainer spring is fully in groove all around connecting rod; see pump manual.
	Connecting rod assembly damaged; see pump manual.	Replace connecting rod assembly; see pump manual.
	Gears or drive housing damaged.	Inspect drive housing assembly and gears for damage and replace if necessary; see pump manual.

## Electrical

				
<p>Keep clear of electrical and moving parts during troubleshooting procedures. To avoid electrical shock hazards when covers are removed for troubleshooting, wait 5 minutes after unplugging power cord for stored electricity to dissipate.</p>				

If sprayer does not run or does not shut off, follow the steps below before beginning to troubleshoot electrical issues.

1. Perform **Pressure Relief Procedure**, page 18.
2. Plug sprayer into correct voltage, grounded outlet.
3. Set power switch OFF for 30 seconds and then ON again (this ensures sprayer is in normal run mode).

4. Turn pressure control knob clockwise 1/2 turn.
5. Observe BlueLink status light to diagnose and resolve error codes in the following Troubleshooting chart.

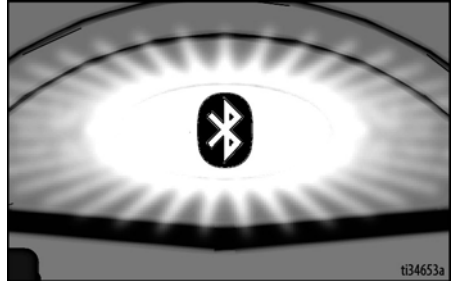

Blinking red LED total count equals the error code (for example: two blinks equals CODE 02).

**NOTE:** Use BlueLink app for more information about error codes.

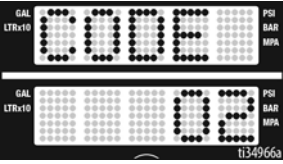
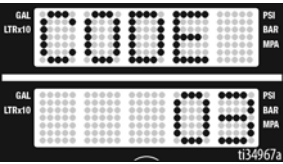
Problem	Cause	Solution
<ul style="list-style-type: none"> <li>Sprayer does not run at all</li> <li>Display is blank</li> <li>BlueLink status light never lights up</li> </ul>	Multiple electrical issues.	See flow chart, page 46.
<p>Sprayer will not shut off</p>	Multiple electrical issues.	See flow chart, page 48.
<ul style="list-style-type: none"> <li>Sprayer does not run at all</li> <li>Display shows CODE 02</li> </ul>  <ul style="list-style-type: none"> <li>BlueLink status light blinks 2 times repeatedly</li> </ul>	Transducer or transducer connection issue.	<ol style="list-style-type: none"> <li>Make sure there is no pressure in the system (see <b>Pressure Relief Procedure</b>, page 18). Check fluid path for clogs, such as clogged filter.</li> <li>Use airless paint spray Hose with no metal braid 1/4 in. x 50 ft minimum. Smaller Hose or metal braid Hose may result in high-pressure spikes.</li> <li>Set sprayer to OFF and disconnect power to sprayer.</li> <li>Check transducer and connections to control board.</li> <li>Disconnect transducer from control board socket. Check that transducer and control board contacts are clean and secure.</li> <li>Reconnect transducer to control board socket. Connect power, set sprayer ON and control knob 1/2 turn clockwise. If sprayer does not run properly, set sprayer to OFF and go to next step.</li> <li>Install new transducer. Connect power, set sprayer ON and control knob 1/2 turn clockwise. Replace control board if sprayer does not run properly.</li> </ol>
<ul style="list-style-type: none"> <li>Sprayer does not run at all</li> <li>Display shows CODE 03</li> </ul>  <ul style="list-style-type: none"> <li>BlueLink status light blinks 3 times repeatedly</li> </ul>	Transducer connection issue (control board is not detecting a pressure signal).	<ol style="list-style-type: none"> <li>Set sprayer to OFF and disconnect power to sprayer.</li> <li>Check transducer and connections to control board.</li> <li>Disconnect transducer from control board socket. Check to see if transducer and control board contacts are clean and secure.</li> <li>Reconnect transducer to control board socket. Connect power, set sprayer ON and control knob to 1/2 turn clockwise. If sprayer does not run, set sprayer to OFF and go to next step.</li> <li>Connect a confirmed working transducer to control board socket.</li> <li>Set sprayer ON and control knob to 1/2 turn clockwise. If sprayer runs, install new transducer. Replace control board if sprayer does not run.</li> <li>Check transducer resistance with ohm-meter (less than 9k ohm between red and black wires and 3-6k ohm between green and yellow wires).</li> </ol>

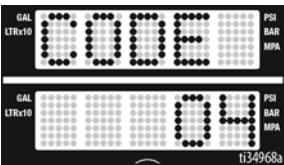
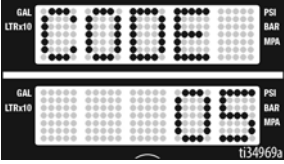
Problem	Cause	Solution
<ul style="list-style-type: none"> <li>Sprayer does not run at all</li> <li>Display shows CODE 4</li> </ul>  <ul style="list-style-type: none"> <li>BlueLink status light blinks four times repeatedly</li> </ul>	<p>Control board detected voltage surges.</p>	<p>Set sprayer to OFF and disconnect power to sprayer. Locate a good voltage supply to prevent damage to electronics.</p>
<ul style="list-style-type: none"> <li>Sprayer does not run at all</li> <li>Display shows CODE 05</li> </ul>  <ul style="list-style-type: none"> <li>BlueLink status light blinks 5 times repeatedly</li> </ul>	<p>Control is commanding motor to run but motor shaft does not rotate.</p>	<ol style="list-style-type: none"> <li>Remove pump and try to run sprayer. If motor runs, check for locked or frozen pump or drive train. If sprayer does not run, continue to step 2.</li> <li>Set sprayer to OFF and disconnect power to sprayer.</li> <li>Remove motor cover.</li> <li>Disconnect motor connector(s) above motor. Check that connectors are clean. Reconnect connectors. Check that connectors are fully seated and secure.</li> <li>Set sprayer to OFF and spin motor fan 1/2 turn. Restart sprayer. If sprayer runs, replace control board. If sprayer does not run, continue to step 5.</li> <li><b>Perform Spin Test:</b> Test at large 4-pin motor field connector. Disconnect fluid pump from sprayer. Test motor by placing a jumper across pins 1 &amp; 2. Rotate motor fan at about 2 revolutions per second. A cogging resistance to motion should be felt at the fan. The motor should be replaced if no resistance is felt. Repeat for pin combinations 1 &amp; 3 and 2 &amp; 3. Pin 4 (the green wire) is not used in this test. If all spin test is positive, continue to step 6.</li> </ol> <p>See connections on next page:</p>

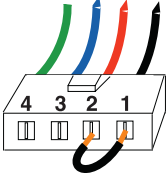
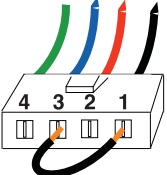
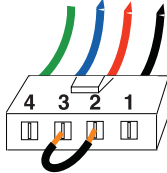
Problem	Cause	Solution
		<p data-bbox="684 245 898 266">Green Blue Red Black</p> <p data-bbox="632 383 732 407"><b>STEP 1:</b></p>  <p data-bbox="692 483 906 505">Green Blue Red Black</p> <p data-bbox="632 615 732 639"><b>STEP 2:</b></p>  <p data-bbox="694 721 908 742">Green Blue Red Black</p> <p data-bbox="635 863 735 888"><b>STEP 3:</b></p> 

# Troubleshooting

## Problem

- Sprayer does not run at all
- Display shows CODE 05

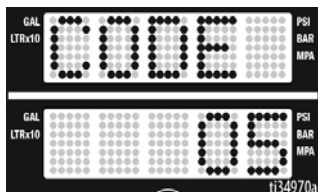

- BlueLink status light blinks 5 times repeatedly

## Cause

Control is commanding motor to run but motor shaft does not rotate.

## Solution

7. **Perform Field Short Test:** Test at large 4-pin motor field connector. There should not be continuity from pin 4, the ground wire, and any of the remaining 3 pins. If motor field connector tests fail, replace motor.
8. **Check Motor Thermal Switch:** Unplug thermal wires. Set meter to ohms. Meter should read the proper resistance for each unit (see table below).

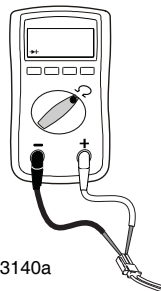

ti13140a

### Resistance Table:

695/240V Mark IV	0 ohms
795/120V Mark IV	2k ohms
1095/230V Mark V	3.9k ohms
1595/120V Mark V/Mark VII	6.2k ohms
Mark X	10.0k ohms

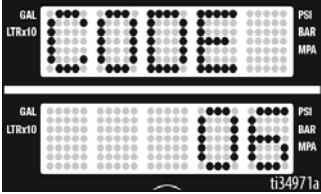
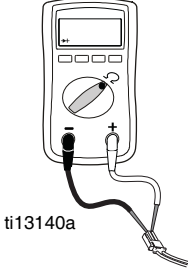
Problem	Cause	Solution												
<ul style="list-style-type: none"> <li>Sprayer does not run at all</li> <li>Display shows CODE 06</li> </ul>  <ul style="list-style-type: none"> <li>BlueLink status light blinks 6 times repeatedly</li> </ul>	<p>Motor overheated</p>	<p><b>NOTE:</b> Motor must be cooled down for the test.</p> <ol style="list-style-type: none"> <li>Keep sprayer in cooler location with good ventilation. Make sure motor air intake is not blocked.</li> <li>Remove motor cover. Ensure fan is securely attached to motor shaft.</li> <li>Check thermal switch connector (yellow wires) above motor.</li> <li>Disconnect thermal switch connector above motor. Make sure contacts are clean and secure. Measure resistance of the thermal switch. If reading is not correct, replace motor.</li> </ol> <p><b>Check Motor Thermal Switch:</b> Unplug thermal wires. Set meter to ohms. Meter should read the proper resistance for each unit (see table below).</p>  <p>ti13140a</p> <table border="1" data-bbox="625 948 1025 1133"> <thead> <tr> <th colspan="2">Resistance Table:</th> </tr> </thead> <tbody> <tr> <td>695/240V Mark IV</td> <td>0 ohms</td> </tr> <tr> <td>795/120V Mark IV</td> <td>2k ohms</td> </tr> <tr> <td>1095/240V Mark V</td> <td>3.9k ohms</td> </tr> <tr> <td>1595/120V Mark V/Mark VII</td> <td>6.2k ohms</td> </tr> <tr> <td>Mark X</td> <td>10.0k ohms</td> </tr> </tbody> </table> <ol style="list-style-type: none"> <li>Reconnect thermal switch connector to control board socket. Connect power, turn sprayer ON and turn pressure control knob 1/2 turn clockwise. If sprayer does not run, replace control board.</li> </ol>	Resistance Table:		695/240V Mark IV	0 ohms	795/120V Mark IV	2k ohms	1095/240V Mark V	3.9k ohms	1595/120V Mark V/Mark VII	6.2k ohms	Mark X	10.0k ohms
Resistance Table:														
695/240V Mark IV	0 ohms													
795/120V Mark IV	2k ohms													
1095/240V Mark V	3.9k ohms													
1595/120V Mark V/Mark VII	6.2k ohms													
Mark X	10.0k ohms													

# Troubleshooting

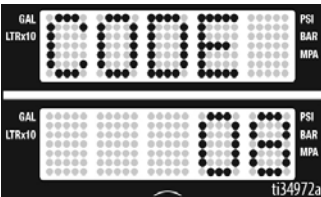
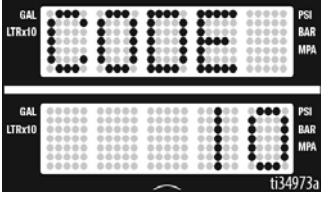
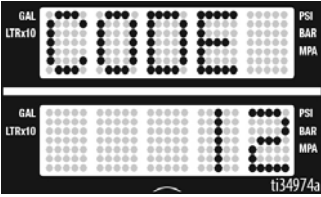
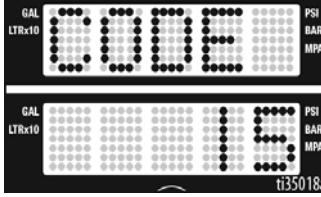
Problem	Cause	Solution
<ul style="list-style-type: none"> <li>Sprayer does not run at all</li> <li>Display shows CODE 08</li> </ul>  <ul style="list-style-type: none"> <li>BlueLink status light blinks eight times repeatedly</li> </ul>	<p>Incoming voltage too low for sprayer operation</p>	<ol style="list-style-type: none"> <li>Set sprayer to OFF and disconnect power to sprayer.</li> <li>Remove other equipment that uses the same circuit.</li> <li>Locate a good voltage supply to avoid damage to electronics.</li> </ol>
<ul style="list-style-type: none"> <li>Sprayer does not run at all</li> <li>Display shows CODE 10</li> </ul>  <ul style="list-style-type: none"> <li>BlueLink status light blinks 10 times repeatedly</li> </ul>	<p>Control board is over heating.</p>	<ol style="list-style-type: none"> <li>Make sure motor air intake is not blocked.</li> <li>Make sure fan is securely attached to motor shaft.</li> <li>Replace control board.</li> <li>Replace motor.</li> </ol>
<ul style="list-style-type: none"> <li>Sprayer does not run at all</li> <li>Display shows CODE 12</li> </ul>  <ul style="list-style-type: none"> <li>BlueLink status light blinks 12 times repeatedly</li> </ul>	<p>Excessive current protection enabled</p>	<p>Cycle power on and off.</p>
<ul style="list-style-type: none"> <li>Sprayer does not run at all</li> <li>Display shows CODE 15</li> </ul>  <ul style="list-style-type: none"> <li>BlueLink status light blinks 15 times repeatedly</li> </ul>	<p>Motor not spinning (no current to motor)</p>	<ol style="list-style-type: none"> <li>Set sprayer to OFF and disconnect power to sprayer.</li> <li>Remove motor cover.</li> <li>Disconnect motor control and inspect for damage at connectors.</li> <li>Reconnect motor control.</li> <li>Turn power on. If code continues, replace control board.</li> </ol>

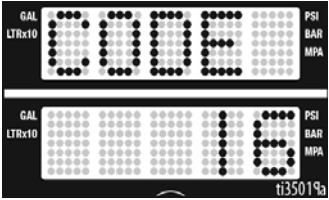
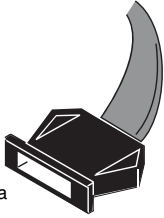
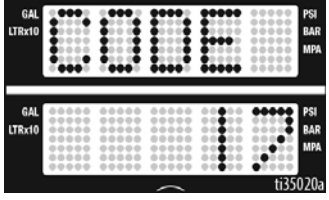
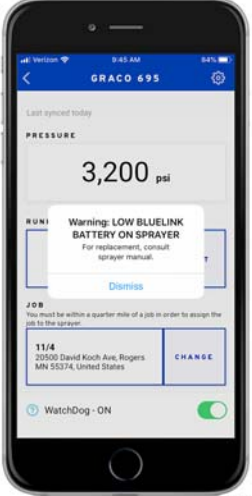

Problem	Cause	Solution
<ul style="list-style-type: none"> <li>Sprayer does not run at all</li> <li>LED Display shows CODE 16</li> </ul>  <ul style="list-style-type: none"> <li>BlueLink status light blinks 16 times repeatedly</li> </ul>	<p>Motor position sensor not working</p>	<ol style="list-style-type: none"> <li>Set sprayer to OFF and disconnect power to sprayer.</li> <li>Remove motor cover.</li> <li>Disconnect motor position sensor and inspect for damage at connectors.</li> </ol>  <p>ti18685a</p> <ol style="list-style-type: none"> <li>Reconnect sensor.</li> <li>Turn power ON. If code continues, replace motor.</li> </ol>
<ul style="list-style-type: none"> <li>Sprayer does not run at all</li> <li>Display shows CODE 17</li> </ul>  <ul style="list-style-type: none"> <li>BlueLink status light blinks 17 times repeatedly</li> </ul>	<p>Sprayer plugged into wrong voltage</p>	<ol style="list-style-type: none"> <li>Set sprayer to OFF and disconnect power to sprayer.</li> <li>Locate a good voltage supply to avoid damage to electronics.</li> </ol>
<ul style="list-style-type: none"> <li>Error appears in Graco BlueLink App</li> </ul> 	<p>Battery depleted</p>	<p>See <b>Replacing BlueLink Battery</b>, page 31.</p>

# Troubleshooting

## Electrical cont...

Sprayer does not run at all, display is blank, or BlueLink status light never lights up.

(See following page for steps)

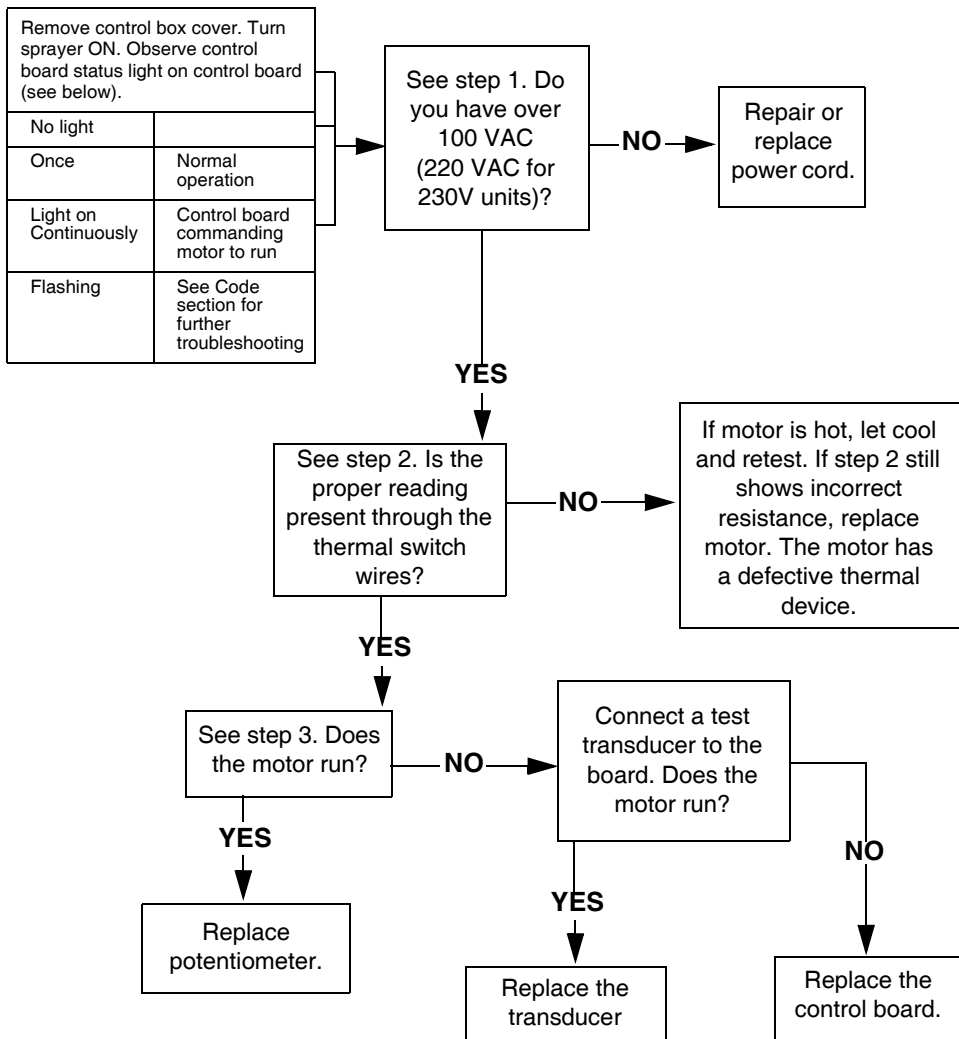

## STEP 1:

Plug power cord in and turn switch ON. Connect probes to on/off switch. Turn meter to AC Volts.

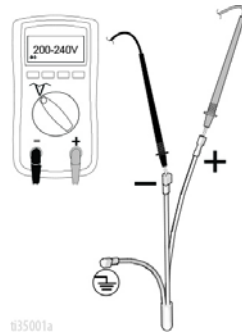

## STEP 2:

Check motor thermal switch. Unplug yellow wires above motor. Meter should read according to Resistance Table on page 42. **NOTE:** Motor should be cool during reading.

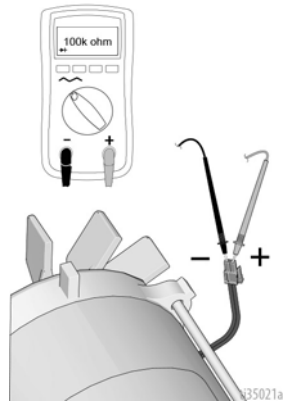

## STEP 3:

Plug power cord in and turn switch ON. Disconnect potentiometer.

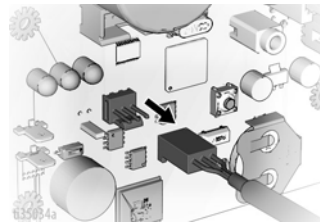

# Troubleshooting

## Electrical cont...

### Sprayer Will Not Shut Off

1. Perform **Pressure Relief Procedure**, page 18. Leave prime valve open, turn power switch OFF, and unplug sprayer from power outlet.
2. Follow the troubleshooting procedure below.

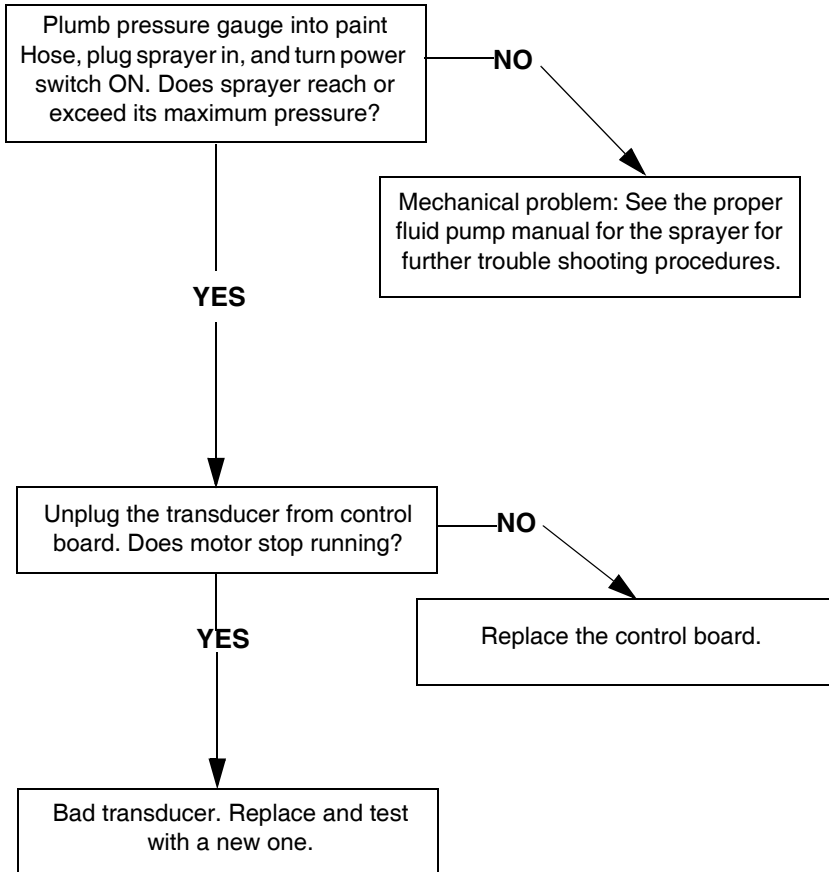



# 695/795 Lo-Boy Standard Parts

## 695/795 Lo-Boy Standard Parts

Ref.	Torque
①	40-45 in-lb (4.5 - 5.0 N•m)
②	9-11 in-lb (1.0 - 1.2 N•m)
③	200-230 in-lb (22.6 - 25.9 N•m)
④	190-210 in-lb (21.4 - 23.7 N•m)
⑤	22-28 in-lb (2.4 - 3.1 N•m)
⑥	25-30 ft-lb (33.8 - 40.6 N•m)
⑦	70-80 ft-lb (94.9 - 108.4 N•m)
⑧	130-150 in-lb (14.6 - 16.9 N•m)
⑨	65-85 in-lb (7.3 - 9.6 N•m)

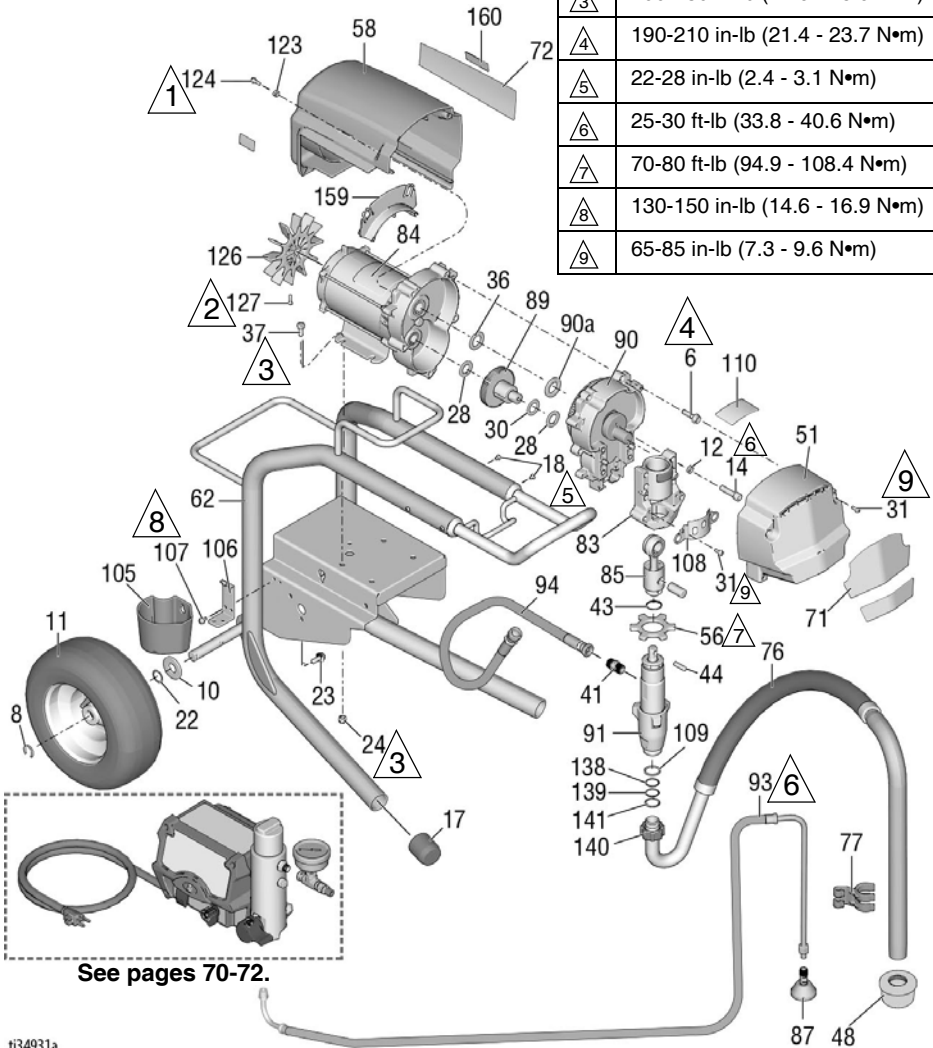

ti34931a

# 695/795 Lo-Boy Standard Parts

## 695/795 Lo-Boy Standard Parts List

Ref.	Part	Description	Qty.	Ref.	Part	Description	Qty.
6	15C753	SCREW, mach, torx, hex	5	87	241920	DEFLECTOR, threaded	1
8	15E891	CLIP, retaining	2	89	287289	GEAR, combination; <i>includes 28, 30</i>	1
10	156306	WASHER, flat	2	90	287283	HOUSING, drive <i>includes 6, 36, 90a</i>	1
11*	119420	WHEEL, pneumatic	2	90a	107089	WASHER, race, thrust	1
12	106115	WASH, lock, spring	4	91	16Y598	PUMP, displacement 695/795	1
14	17E788	SCREW, cap, socket hd	4	93	248217	HOSE, drain; <i>includes 87</i>	1
17	15C871	CAP, leg	2	94	16X904	HOSE, coupled, 3/8 x 19.5	1
18	109032	SCREW, mach, pnh	4	99	24A249	HANDLE, cart	1
22	116038	WASHER, wave spring	2	105	276975	CUP, drain	1
24	111040	NUT, hex, flanged	4	106	15F952	BRACKET, drain cup	1
28	114672	WASHER, thrust	2	107	114423	SCREW, mach, hex hd	2
30	114699	WASHER, thrust	1	108	16X770	SHIELD, pump rod	1
31	118444	SCREW, machine, hex washer hd	6	109	115099	WASHER, garden Hose	1
36	116191	WASHER, thrust	1	110	17E924	LABEL, Standard Series Ultra	1
37	100057	SCREW, cap, hex hd	4		17G987	Ultimate	
41	196178	FITTING	1	117	187437	LABEL, torque	1
43	176817	SPRING, retaining	1	123	276980	GROMMET, cover	2
44	176818	PIN, str, hdls	1	124	119250	SCREW, shoulder, hex washer	2
48	189920	STRAINER, (1-11 1/2 NPSM)	1	126	15D088	FAN, motor	1
51	24V023	COVER, drive, plastic, painted; <i>includes 31</i>	1	127	115477	SCREW, mach, torx, pan hd	1
56	17A257	NUT, retaining	1	128▲		TAG, WARNING (not shown)	1
58	287281	695 SHIELD, motor, painted; <i>includes 123, 124</i>	1		222385	English, French, Spanish	
62	24Y424	FRAME, cart	1		17A134	English, Chinese, Korean	
71		LABEL, front	1		17R476	English, Spanish, Portuguese	
72	17E728	Ultra 695		138	117559	O-RING	2
	17E730	Ultra 795		139	118505	RING, retaining, external	1
	17E736	Ultimate 695		140	15C980	NUT, jam	1
		LABEL, side	1	141	15C981	WASHER, suction swivel	1
	17E729	Ultra 695		159	278075	BAFFLE	1
	17E731	Ultra 795		160	15Y118	LABEL, Made in USA	1
	17E737	Ultimate 695					
76	248216	HOSE, suction; <i>includes 109, 138, 139, 140, 141</i>	1				
77	15D000	CLIP, drain line	1				
83	24V026	HOUSING, bearing; <i>includes 12, 14, 31, 108, 117</i>	1				
84	257185	MOTOR, electric; <i>includes 126, 127</i>	1				
85	241008	ROD, connecting; <i>includes 43</i>	1				

\* 253132 KIT, repair, tube, 11 in.

▲ Replacement safety labels, tags, and cards are available at no cost.

# 695/795/Mark IV HD Hi-Boy Standard Parts

## 695/795/Mark IV HD Hi-Boy Standard Parts

Ref.	Torque
①	40-45 in-lb (4.5 - 5.0 N•m)
②	9-11 in-lb (1.0 - 1.2 N•m)
③	200-230 in-lb (22.6 - 25.9 N•m)
④	190-210 in-lb (21.4 - 23.7 N•m)
⑤	22-28 in-lb (2.4 - 3.1 N•m)
⑥	25-30 ft-lb (33.8 - 40.6 N•m)
⑦	70-80 ft-lb (94.9 - 108.4 N•m)
⑧	130-150 in-lb (14.6 - 16.9 N•m)
⑨	65-85 in-lb (7.3 - 9.6 N•m)

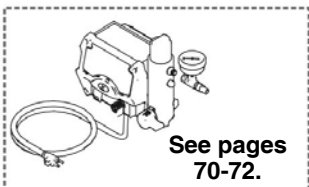
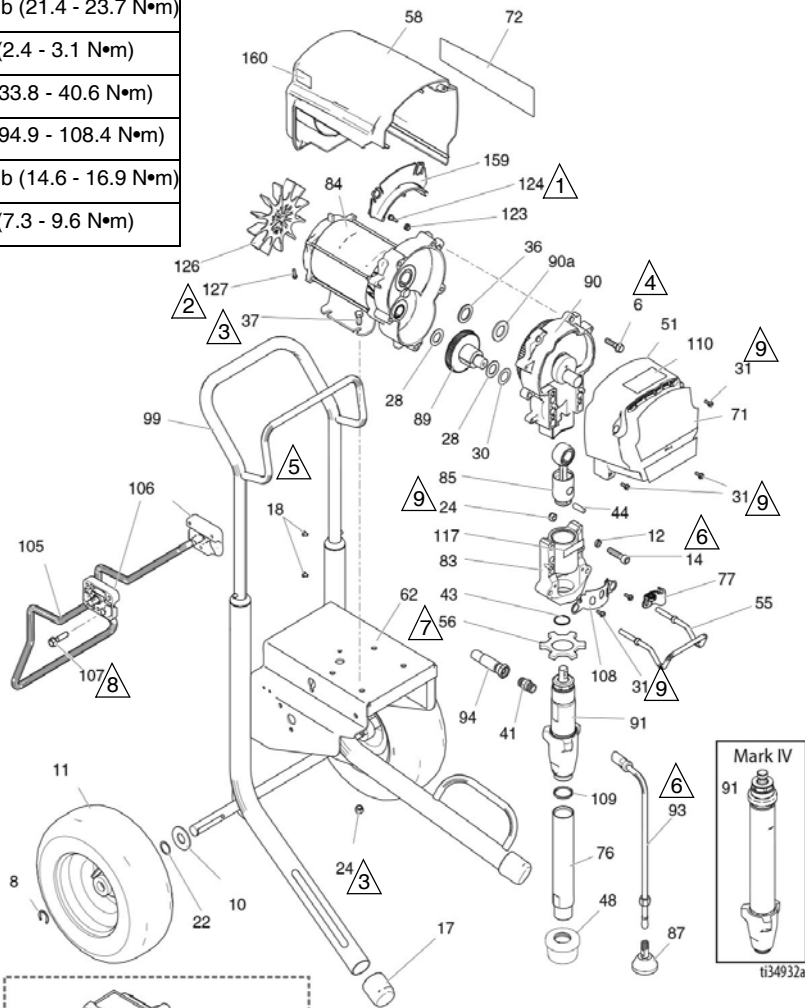



# 695/795/Mark IV HD Hi-Boy Standard Parts

## 695/795/Mark IV HD Hi-Boy Standard Parts List

Ref. Part	Description	Qty.	Ref. Part	Description	Qty.
6	15C753	SCREW, mach, torx, hex	5	257185	695/Mark IV HD 230V
8	15E891	CLIP, retaining	2	257186	795/Mark IV HD 120V
10	156306	WASHER, flat	2	85 241008	ROD, connecting; <i>includes 43</i>
11*	119420	WHEEL, pneumatic	2		
12	106115	WASH, lock, spring	4	87 241920	DEFLECTOR, threaded
14	17E788	SCREW, cap, socket hd	4	89 287289	GEAR, combination; <i>includes 28, 30</i>
17	15C871	CAP, leg	2		
18	109032	SCREW, mach, pnh	4	90	HOUSING, drive; <i>includes 6, 36, 90a</i>
22	116038	WASHER, wave spring	2		
24	111040	NUT, hex, flanged	6	287283	695/Mark IV 230V
28	114672	WASHER, thrust	2	287284	795/Mark IV 120V
30	114699	WASHER, thrust	1	90a 107089	WASHER, race, thrust
31	118444	SCREW, machine, hex washer hd	6	91	PUMP, displacement; <i>includes 41, 109</i>
36	116191	WASHER, thrust	1	16Y598	695/795
37	100057	SCREW, cap, hex hd	4	17H828	Mark IV HD
41	196178	FITTING	1	93 244240	HOSE, coupled; <i>includes 87</i>
43	176817	SPRING, retaining	1		
44	176818	PIN, str, hdls	1	94 16X904	HOSE, coupled, 3/8 x 19.5
48	189920	STRAINER, (1-11 1/2 NPSM)	1	99 287489	HANDLE, cart
51	24V023	COVER, drive, plastic, painted; <i>includes 31</i>	1	105 16X695	HANGER, stand, cart
55	16C457	HANGER, pail	1	106 15C982	CAM, cart
56	17A257	NUT, retaining	1	107 114531	SCREW, mach, hex washer
58		SHIELD, motor, painted; <i>includes 123, 124</i>	1	108 16X770	SHIELD, pump rod
	287281	695/Mark IV 230V	1	109 118494	PACKING, o-ring
	287282	795/Mark IV 120V	1	110	LABEL, Standard Series Ultra/Mark
62	24Y429	FRAME, cart	1	17E924	Ultimate
71		LABEL, front	1	17G987	LABEL, torque
	17E728	Ultra 695	1	123 276980	GROMMET, cover
	17E730	Ultra 795	1	124 119250	SCREW, shoulder, hex, washer
	17E736	Ultimate 695	1	126 15D088	FAN, motor
	17E738	Ultimate 795	1	127 115477	SCREW, mach, torx, pan, hd
	17E745	Mark IV HD	1	128	TAG, WARNING (not shown)
72		LABEL, side	1	▲	English, French, Spanish English, Chinese, Korean English, Spanish, Portuguese
	17E729	Ultra 695	1	222385	BAFFLE
	17E731	Ultra 795	1	17A134	LABEL, Made in USA
	17E737	Ultimate 695	1	17R476	
	17E739	Ultimate 795	1		
	17E744	Mark IV HD 230V	1	159 278075	
	17E746	Mark IV HD 120V	1	160 15Y118	
76	248214	TUBE, intake; <i>includes 109</i>	1		
77	278204	CLIP, spring	1		
83	24V026	HOUSING, bearing; <i>includes 12, 14, 24, 31, 55, 77, 108, 117</i>	1		
84		MOTOR, electric; <i>includes 106, 127</i>	1		

\* 253132 KIT, repair, tube, 11 in.

▲ Replacement safety labels, tags, and cards are available at no cost.

# 1095/1595/Mark V HD/Mark VII HD Hi-Boy

## 1095/1595/Mark V HD/Mark VII HD Hi-Boy Standard Parts

Ref.	Torque
①	40-45 in-lb (4.5 - 5.0 N•m)
②	9-11 in-lb (1.0 - 1.2 N•m)
③	200-230 in-lb (22.6 - 25.9 N•m)
④	190-210 in-lb (21.4 - 23.7 N•m)
⑤	22-28 in-lb (2.4 - 3.1 N•m)
⑥	25-30 ft-lb (33.8 - 40.6 N•m)
⑦	70-80 ft-lb (94.9 - 108.4 N•m)
⑧	130-150 in-lb (14.6 - 16.9 N•m)
⑨	65-85 in-lb (7.3 - 9.6 N•m)

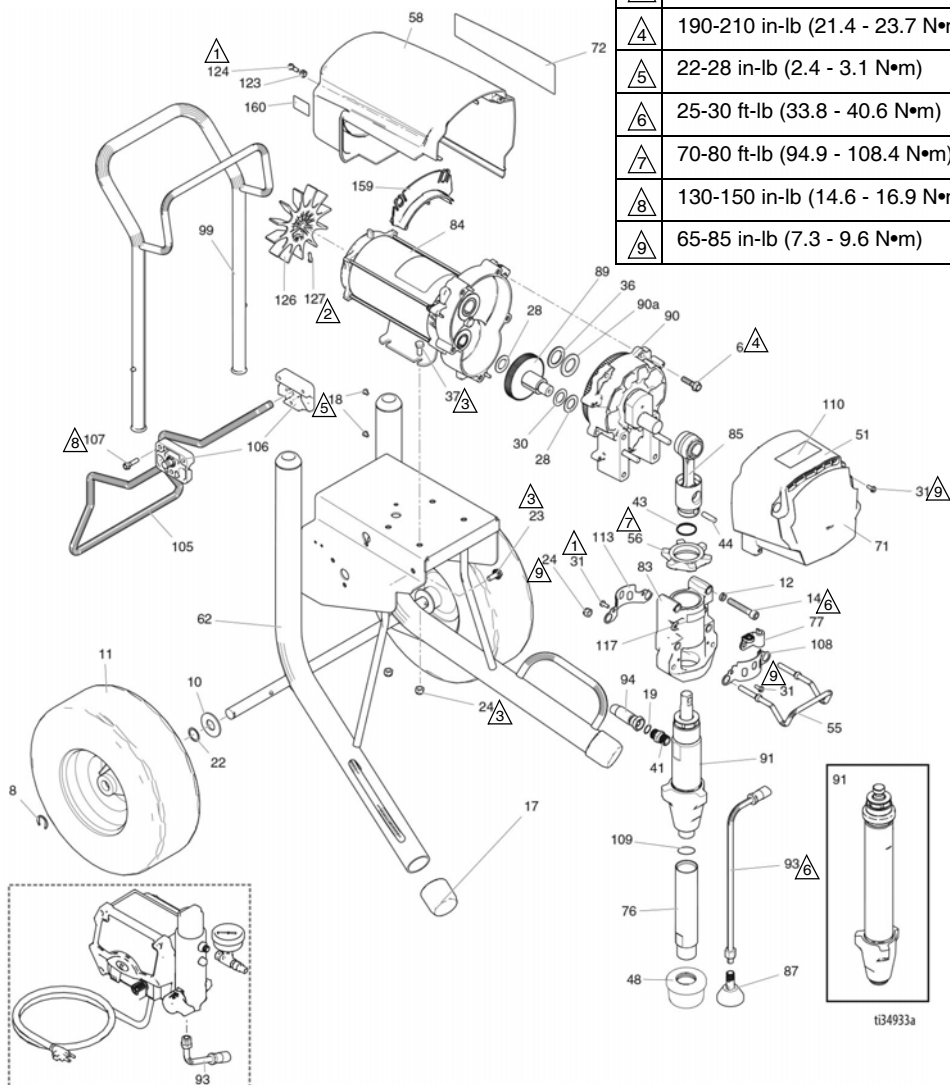

See pages 70-72.

# 1095/1595/Mark V HD/Mark VII HD Hi-Boy

## 1095/1595/Mark V HD Hi-Boy Standard Parts List









Ref. Part	Description	Qty.	Ref. Part	Description	Qty.	
6	15C753	SCREW, mach, torx, hex	5	257187	1095/Mark V 230V/Mark V Japan	
8	15E891	CLIP, retaining	2	257188	1595/Mark V 120V/UK Mark V/Mark VII	
10	156306	WASHER, flat	2	85	24V021	ROD, connecting; <i>includes 43, 44</i>
11*	119509	WHEEL, pneumatic	2	87	241920	DEFLECTOR, threaded
12	106115	WASH, lock, spring	4	89	287290	GEAR, combination; <i>includes 28, 30</i>
14	17E789	SCREW, cap, socket hd	4	90		HOUSING, drive <i>includes 6, 36, 90a</i>
17	276974	CAP, leg	2	287294		1095 110V/120V
18	108795	SCREW, mach, pnh	4	287295		1095 230V/1595/Mark V
19	102982	PACKING, o-ring (Mark V/Mark VII)	1	24M417		Mark VII
22	116038	WASHER, wave spring	2	90a	194173	WASHER, race, thrust
23	117791	SCREW, cap, flng hd	2	91		PUMP, displacement; <i>includes 41, 76, 109</i>
24	111040	NUT, hex, flanged	6	16Y706		1095/1595
28	114672	WASHER, thrust	2	17H829		Mark V
30	114699	WASHER, thrust	1	17H830		Mark VII
31	118444	SCREW, machine, hex washer hd	8	93	244240	HOSE, drain; <i>includes 87</i>
36	116192	WASHER, thrust	1	94		HOSE, coupled 3/8 x 15.75
37	100057	SCREW, cap, hex hd	4	16X904		1095/1595
41		FITTING, pump, quick disc	1	24V029		Mark V/Mark VII; <i>includes 19</i>
	196178	1095/1595		99	24A250	HANDLE, cart
	16X834	Mark V HD / Mark VII HD		105	16X696	HANGER, stand, cart
43	119778	SPRING, retaining	1	106	15C982	CAM, cart
44	183210	PIN, pump	1	107	114531	SCREW, mach, hex washer
48	189920	STRAINER, (1-11 1/2 NPSM)	1	108	16X770	PUMP, shield rod
51	24V024	COVER, drive, plastic, painted; <i>includes 31</i>	1	109	118494	PACKING, o-ring
55	16C457	HANGER, pail	1	110		LABEL, Standard Series
56	193031	NUT, retaining	1	17E924		Ultra/Mark
58	287282	SHIELD, motor, painted; <i>includes 123, 124</i>	1	17G987		Ultimate
62	24Y428	FRAME, cart 1095/1595	1	113	15C762	SHIELD, pump rod
71		LABEL, UltraMax	1	117	187437	LABEL, torque
	17E732	Ultra 1095		123	276980	GROMMET, cover
	17E734	Ultra 1595		124	119250	SCREW, shoulder, hex, washer
	17E740	Ultimate 1095		126	15D088	FAN, motor
	17E742	Ultimate 1595		127	115477	SCREW, mach, torx, pan, hd
	17E747	Mark V HD		128▲		TAG, WARNING (not shown)
	17E749	Mark VII HD			222385	English, French, Spanish
72		LABEL, UltraMax II 1095/1595	1		17A134	English, Chinese, Korean
	17E733	Ultra 1095			17R476	English, Spanish, Portuguese
	17E735	Ultra 1595		159	278075	BAFFLE
	17E741	Ultimate 1095		160	15Y118	LABEL, Made in USA
	17E743	Ultimate 1595		161	110476	FITTING, Mark VII
	17E748	Mark V HD				
	17E750	Mark VII HD				
76	248215	TUBE, intake; <i>includes 109</i>	1			
77	278204	CLIP, drain line	1			
83	24V027	HOUSING, bearing; <i>includes 12, 14, 24, 31, 55, 77, 108, 113, 117</i>	1			
84		MOTOR, electric; <i>includes 126, 127</i>	1			

\* 253132 KIT, repair, tube, 11 in.

▲ Replacement safety labels, tags, and cards are available at no cost.

# Mark X HD Standard Parts

## Mark X HD Standard Parts

Ref.	Torque
	40-45 in-lb (4.5 - 5.0 N•m)
	55-60 in-lb (6.2 - 6.7 N•m)
	200-230 in-lb (22.6 - 25.9 N•m)
	190-210 in-lb (21.4 - 23.7 N•m)
	22-28 in-lb (2.4 - 3.1 N•m)
	25-30 ft-lb (33.8 - 40.6 N•m)
	70-80 ft-lb (94.9 - 108.4 N•m)
	130-150 in-lb (14.6 - 16.9 N•m)
	65-85 in-lb (7.3 - 9.6 N•m)

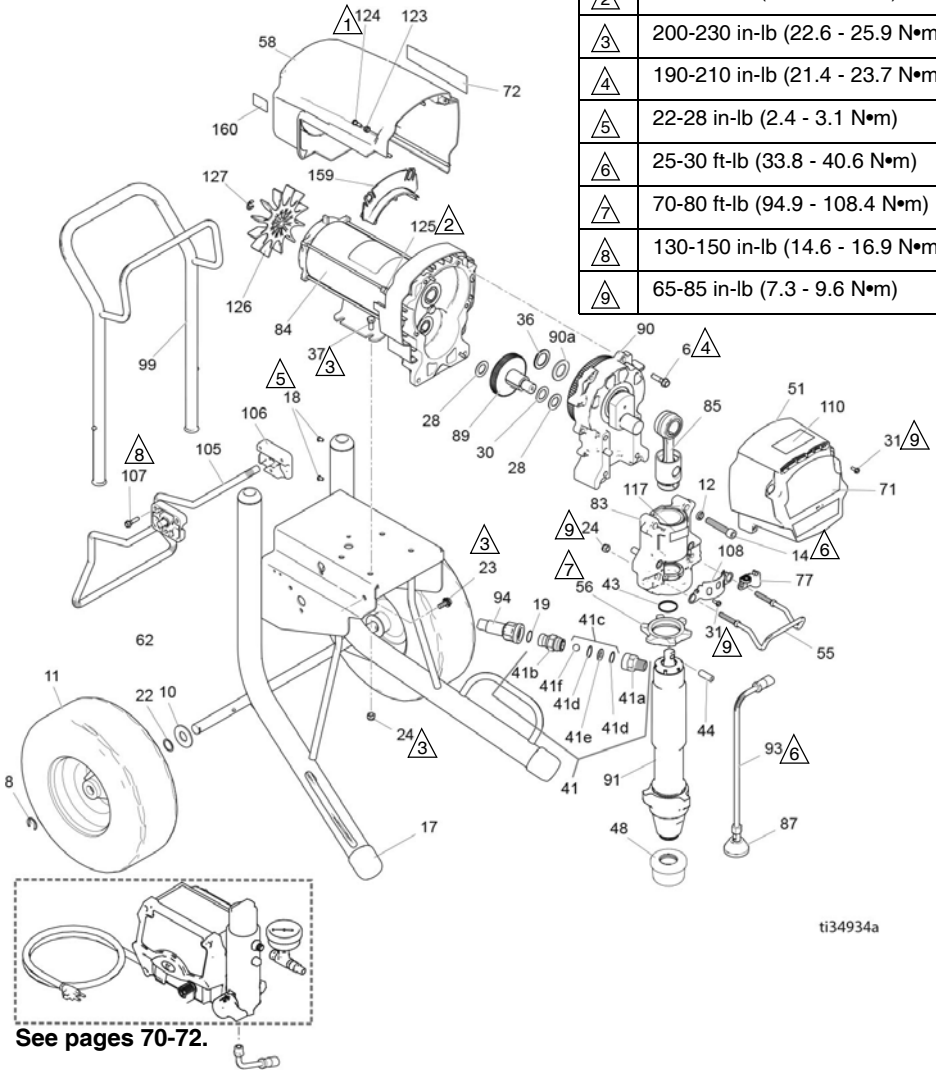











## Mark X HD Standard Parts List

Ref.	Part	Description	Qty.	Ref.	Part	Description	Qty.
6	15C753	SCREW, mach, torx, hex	6	83	24V028	HOUSING, bearing; <i>includes 12, 14, 24, 31, 55, 77, 108, 117</i>	1
8	15E891	CLIP, retaining	2	84	258909	MOTOR, electric; <i>includes 125, 126, 127</i>	1
10	156306	WASHER, flat	2	85	24V022	ROD, connecting; <i>includes 43, 44</i>	1
11*	119509	WHEEL, pneumatic	2	87	241920	DEFLECTOR, threaded	1
12	112600	WASH, lock, spring	4	89	288035	GEAR, combination; <i>includes 28, 30</i>	1
14	17E790	SCREW, cap, socket hd	4	90	287990	HOUSING, drive; <i>includes 6, 36, 90a</i>	1
17	276974	CAP, leg	2	90a	194173	WASHER, race, thrust	1
18	108795	SCREW, mach, pnh	4	91	17H831	PUMP, displacement	1
19	102982	O-RING	1	93	244240	HOSE, drain; <i>includes 87</i>	1
22	116038	WASHER, wave spring	2	94	24V029	HOSE, coupled; <i>includes 19</i>	1
23	117791	SCREW, cap, flange hd	2	99	24A250	HANDLE, cart	1
24	111040	NUT, lock	6	105	16X696	HANGER, stand, cart	1
28	114672	WASHER, thrust	2	106	15C982	CAM, cart	2
30	114699	WASHER, thrust	1	107	114531	SCREW, mach, hex washer	4
31	118444	SCREW, machine, hex washer hd	6	108	16X770	SHIELD, pump rod	1
36	116192	WASHER, thrust	1	110	17E924	LABEL, Standard series	1
37	100057	SCREW, cap, hex hd	4	117	187437	LABEL, torque	1
41	24U755	VALVE, check, quick disc	1	123	276980	GROMMET, cover	2
41a	16N461	HOUSING, seat, check valve	1	124	119250	SCREW, shoulder, hex, washer	3
41b	16X837	HOUSING, ball, check valve	1	125	15G845	SPACER, standoff	2
41c	24M725	KIT, repair, check valve; <i>includes 41d, 41e, 41f</i>	1	126	15V577	FAN, motor	1
41d		O-RING	2	127	122347	SCREW, mach, torx, pan, hd	1
41e		SEAT	1	128▲		TAG, WARNING (not shown)	1
41f		BALL	1		222385	English, French, Spanish	
43	119677	SPRING, retaining	1		17A134	English, Chinese, Korean	
44	19B144	PIN, pump	1		17R476	English, Spanish, Portuguese	
48	189920	STRAINER, (1-11 1/2 NPSM)	1	159	278075	BAFFLE	1
51	24V025	COVER, drive, plastic, painted; <i>includes 31</i>	1	160	15Y118	LABEL, Made in USA	1
55	16C457	HANGER, pail	1				
56	193394	NUT, retaining	1				
58	287282	SHIELD, motor, painted; <i>includes 123, 124</i>	1				
62	24Y428	FRAME, cart	1				
71	17E751	LABEL, Mark X, front	1				
72	17E752	LABEL, Mark X, side	1				
77	278204	CLIP, drain line	1				

\* 253132 KIT, repair, tube, 11 in.

▲ Replacement safety labels, tags, and cards are available at no cost.

## 695/795/Mark IV HD ProContractor Parts

Ref.	Torque
	40-45 in-lb (4.5 - 5.0 N•m)
	9-11 in-lb (1.0 - 1.2 N•m)
	200-230 in-lb (22.6 - 25.9 N•m)
	190-210 in-lb (21.4 - 23.7 N•m)
	120-130 in-lb (13.5 - 14.6 N•m)
	25-30 ft-lb (33.8 - 40.6 N•m)
	38-42 ft-lb (51.5 - 56.9 N•m)
	130-150 in-lb (14.6 - 16.9 N•m)
	90-110 in-lb (10.1 - 12.4 N•m)
	65-85 in-lb (7.3 - 9.6 N•m)

See Page 68

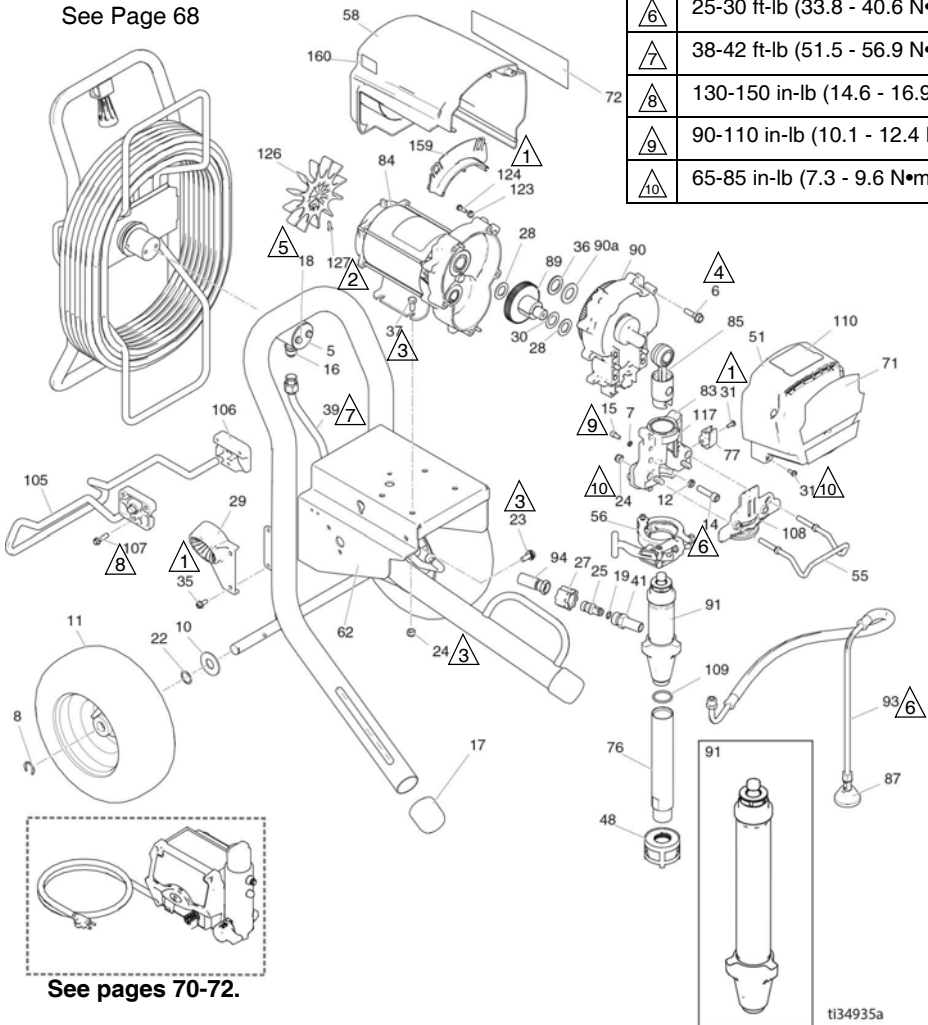











# 695/795/Mark IV HD ProContractor Parts

## 695/795/Mark IV HD ProContractor Parts List

Ref.	Part	Description	Qty.	Ref.	Part	Description	Qty.
5	16C975	PLATE, pivot	1	17E739	795 Ultimate		
6	15C753	SCREW, mach, hex wash hd	5	76	248214	TUBE, intake; <i>includes 109</i>	1
7	105510	WASHER, lock, spring	2	77	16X203	CLIP, drain line	1
8	15E891	CLIP, retaining	2	83	24V087	HOUSING, bearing; <i>includes 7, 12, 14, 15, 24, 31, 55, 56, 77, 108, 117</i>	1
10	156306	WASHER, flat	2	84		MOTOR, electric	1
11	119420	WHEEL, pneumatic	2		257185	695, Mark IV 230V	
12	106115	WASHER, lock (hi-collar)	4		257186	795, Mark IV 120V	
14	17E788	SCREW, cap, sch	4	85	24V084	ROD, connecting	1
15	101550	SCREW, cap, sch	2	87	241920	DEFLECTOR, threaded	1
16	121311	FITTING, connector	1	89	287289	GEAR, combination; <i>includes 28, 30</i>	1
17	276974	CAP, leg	2	90		HOUSING, drive, M1; <i>includes 6, 36, 90a</i>	1
18	260212	SCREW, hex washer hd	2		287283	695, Mark IV 230V	
19		PACKING, o-ring	1		287284	795, Mark IV 120V	
	107505	695/795 Mark IV		90a	107089	WASHER, race, thrust	1
22	116038	WASHER, wave spring	2	91	17H823	PUMP, displacement, 695/795; <i>includes 41, 109</i>	1
23	117791	SCREW, cap tri lobe	2		17H832	PUMP, displacement, Mark IV	
24	111040	NUT, lock, nylon, thin pattern	6	93	244240	HOSE, drain, ultra hi-boy; <i>includes 87</i>	1
25	16X833	FITTING, QD, 695/795	1	94		HOSE, coupled 3/8 x 15.75	1
27	120583	NUT, hand, 695/795	1		16X904	695/795	
28	114672	WASHER, thrust	2		24V029	Mark IV; <i>includes 19</i>	
29	278083	GUIDE, Hose, platinum	1	105	16X697	HANGER, stand	1
30	114699	WASHER, thrust	1	106	15C982	CAM, cart	2
31	118444	SCREW, mach, slot hex wash hd	5	107	114531	SCREW, mach, hex washer hd	4
35	117633	SCREW, slot hex wash hd	2	108	16X228	PLATE, front, 3900 PC11	1
36	116191	WASHER, thrust, 1095/795	1	109	118494	PACKING, o-ring	1
37	100057	SCREW, cap, hex hd	4	110		LABEL, ProContractor Series	1
39	24V095	TUBE, formed, ultra, platinum	1		17E925	Ultra/Mark	
41		FITTING	1		17G988	Ultimate	
	16Y579	695/795		117	187437	LABEL, torque	1
	16X834	Mark IV		123	276980	GROMMET, cover	2
48	15V573	STRAINER, (1-11 1/2 npsm)	1	124	119250	SCREW, shoulder	2
51	24V023	COVER, drive, plastic, painted; <i>includes 31</i>	1	126	15D088	FAN, motor	1
55	16C457	HANGER, pail	1	127	115477	SCREW, mach, torx pan hd	1
56	16X322	CLAMP, pump	1	128▲		TAG, WARNING (not shown)	1
58		SHIELD, motor, painted; <i>includes 123, 124</i>	1		222385	English, French, Spanish	
	287281	695, Mark IV 230V			17A134	English, Chinese, Korean	
	287282	795, Mark IV 120V			17R476	English, Spanish, Portuguese	
62	24Y427	FRAME, platinum, 695/795	1	159	278075	BRACKET, wire	1
71		LABEL, brand, front	1	160	15Y118	LABEL, Made in the USA	1
	17E728	695 Ultra					
	17E730	795 Ultra					
	17E736	695 Ultimate					
	17E738	795 Ultimate					
	17E745	Mark IV HD					
72		LABEL, brand, side	1				
	17E729	695 Ultra					
	17E731	795 Ultra					
	17E744	Mark IV HD					
	17E737	695 Ultimate					

▲ Replacement safety labels, tags, and cards are available at no cost.

## 1095/1595/Mark V HD/Mark VII HD ProContractor Parts

Ref.	Torque
 1	40-45 in-lb (4.5 - 5.0 N•m)
 2	9-11 in-lb (1.0 - 1.2 N•m)
 3	200-230 in-lb (22.6 - 25.9 N•m)
 4	190-210 in-lb (21.4 - 23.7 N•m)
 5	120-130 in-lb (13.5 - 14.6 N•m)
 6	25-30 ft-lb (33.8 - 40.6 N•m)
 7	38-42 ft-lb (51.5 - 56.9 N•m)
 8	130-150 in-lb (14.6 - 16.9 N•m)
 9	90-110 in-lb (10.1 - 12.4 N•m)
 10	65-85 in-lb (7.3 - 9.6 N•m)

See page 68.

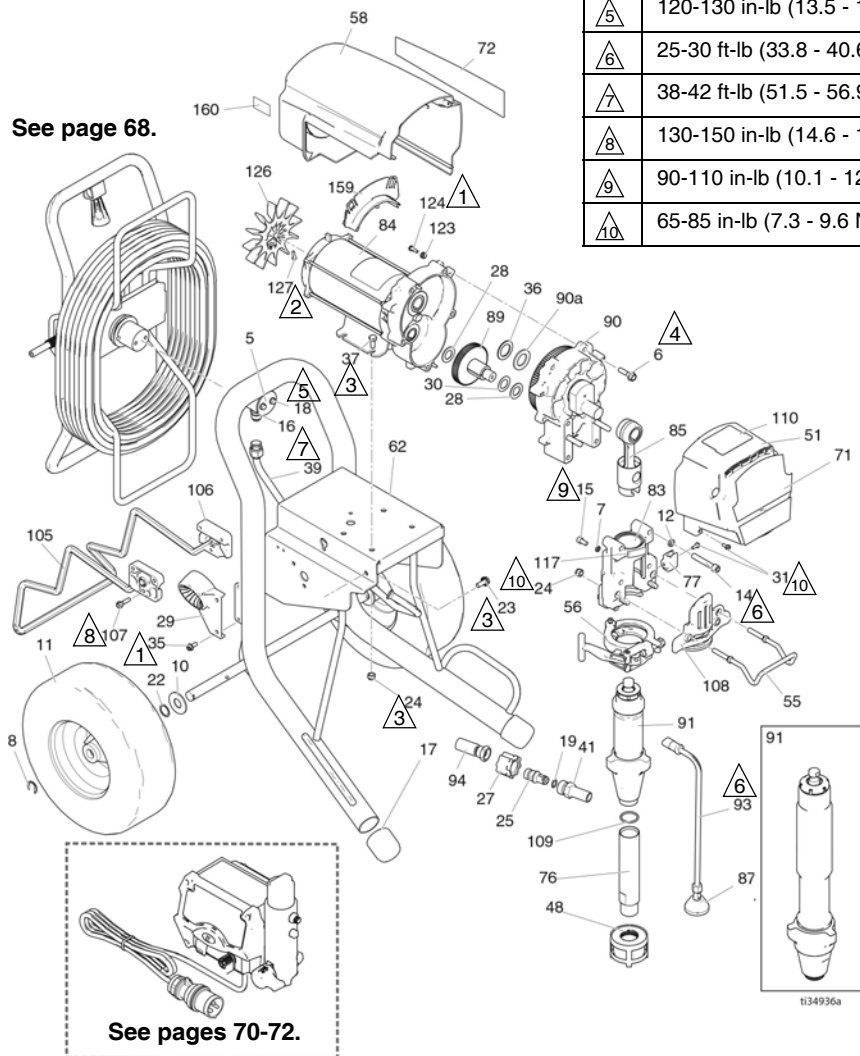

See pages 70-72.

t134936a













## 1095/1595/Mark V HD/Mark VII HD ProContractor Parts List

Ref. Part	Description	Qty.	Ref. Part	Description	Qty.
5	16C975 PLATE, pivot	1	17E743	1595 Ultimate	
6	15C753 SCREW, mach, hex wash hd	5	17E750	Mark VII	
7	105510 WASHER, lock	2	76 248215	TUBE, intake; <i>includes 109</i>	1
8	15E891 CLIP, retaining	2	77 16X203	CLIP, drain line	1
10	156306 WASHER, flat	2	83 24V088	HOUSING, bearing; <i>includes 7, 12, 14, 15, 24, 31, 55, 56, 77, 108, 117</i>	1
11	119509 WHEEL, pneumatic	2			
12	106115 WASHER, lock (hi-collar)	4	84	MOTOR, electric; <i>includes 126, 127</i>	1
14	17E789 SCREW, cap, socket head	4			
15	101550 SCREW, cap, sch	2	257187	1095/Mark V 230V/Mark V Japan	
16	121311 FITTING, connector	1			
17	276974 CAP, leg	2	257188	1595/Mark V 120V/UK Mark V/Mark VII	
18	260212 SCREW, hex washer hd	2			
19	PACKING, o-ring	1	85 24V085	ROD, connecting	1
	107505 1095/1595		87 241920	DEFLECTOR, threaded	1
	102982 Mark V/Mark VII		89 287290	GEAR, combination; <i>includes 28, 30</i>	1
22	116038 WASHER, wave spring	2			
23	117791 SCREW, cap tri lobe	2	90	HOUSING, drive	1
24	111040 NUT, lock, insert	6		<i>includes 6, 36, 90a</i>	
25	16X833 FITTING, quick disconnect, (1095/1595 only)	1	287294	1095 120V/Mark V Japanese	
27	120583 NUT, hand (1095/1595 only)	1	287295	1095 230V/1595/Mark V	
28	114672 WASHER, thrust	2	24M417	Mark VII	
29	278083 GUIDE, Hose, Ultra Platinum	1	90a 194173	WASHER, race, thrust	1
	24M197 GUIDE, Hose, Mark VII	1	91	PUMP, displacement; <i>includes 41, 76, 109</i>	1
30	114699 WASHER, thrust	1	17H824	1095/1595 Models	
31	118444 SCREW, mach, slot hex wash hd	5	17H834	Mark VII	
35	117633 SCREW, slot hex wash hd	2	17H833	Mark V Models	
36	116192 WASHER, thrust, 1595	1	93 244240	HOSE, drain; <i>includes 87</i>	1
37	100057 SCREW, cap, hex hd	4	94	HOSE, coupled 3/8 x 15.75	1
39	24J081 TUBE, formed, ultra, platinum	1	16X904	1095/1595	
41	FITTING, pump, QD	1	24V029	Mark V; <i>includes 19</i>	
	16Y579 1095/1595		105 16X698	HANGER, stand, cart	1
	16X834 Mark V/Mark VII HD		106 15C982	CAM, cart	2
48	15V573 STRAINER, (1-11 1/2 npsm)	1	107 114531	SCREW, mach, hex washer hd	4
51	24V024 COVER, drive, plastic, painted; <i>includes 31</i>	1	108 16X385	PLATE, front, 5900 PCII	
55	16C457 HANGER, pail	1	109 118494	PACKING, o-ring	1
56	16X324 CLAMP, pump, large	1	110	LABEL, ProContractor Series	1
58	287282 SHIELD, motor, painted; <i>includes 123, 124</i>	1	17E925	Ultra/Mark	
62	24Y426 FRAME, platinum, 1095/Mark V	1	17G988	Ultimate	
71	LABEL, brand, front	1	117 187437	LABEL, torque	1
	17E732 1095 Ultra		123 276980	GROMMET, cover	2
	17E734 1595 Ultra		124 119250	SCREW, shoulder	3
	17E747 Mark V HD		126 15D088	FAN, motor	1
	17E740 1095 Ultimate		127 115477	SCREW, mach, torx pan hd	1
	17E742 1595 Ultimate		128▲	TAG, WARNING (not shown)	1
	17E749 Mark VII HD		222385	English, French, Spanish	
72	LABEL, brand, side	1	17A134	English, Chinese, Korean	
	17E733 1095 Ultra		17R476	English, Spanish, Portuguese	
	17E735 1595 Ultra		159 278075	BRACKET, wire	1
	17E748 Mark V HD		160 15Y118	LABEL, Made in the USA	1
	17E741 1095 Ultimate				

▲ Replacement safety labels, tags, and cards are available at no cost.

## Mark X HD ProContractor Parts

Ref.	Torque
	40-45 in-lb (4.5 - 5.0 N•m)
	55-60 in-lb (6.2 - 6.7 N•m)
	200-230 in-lb (22.6 - 25.9 N•m)
	190-210 in-lb (21.4 - 23.7 N•m)
	120-130 in-lb (13.5 - 14.6 N•m)
	25-30 ft-lb (33.8 - 40.6 N•m)
	38-42 ft-lb (51.5 - 56.9 N•m)
	130-150 in-lb (14.6 - 16.9 N•m)
	90-110 in-lb (10.1 - 12.4 N•m)
	65-85 in-lb (7.3 - 9.6 N•m)

See page 68.

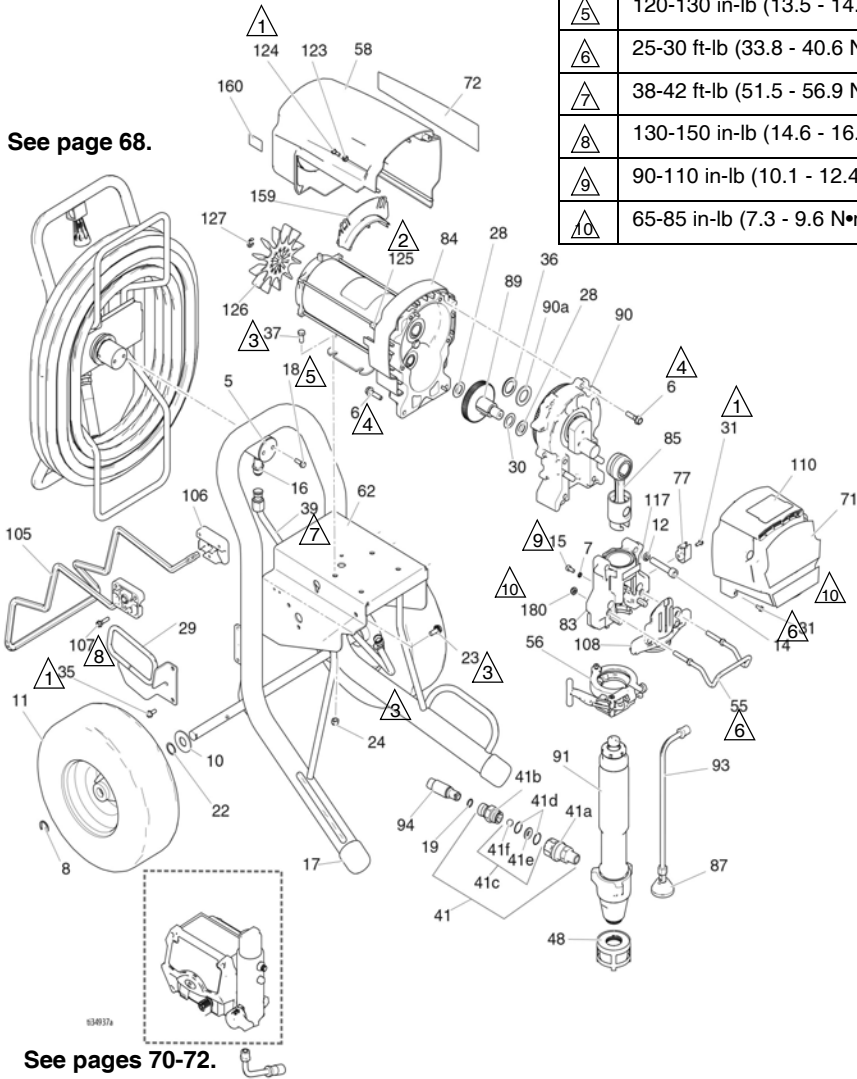

See pages 70-72.

# Mark X HD ProContractor Parts

## Mark X HD ProContractor Parts List

Ref.	Part	Description	Qty.	Ref.	Part	Description	Qty.
5	16C975	PLATE, pivot	1	71	17E751	LABEL, front	1
6	15C753	SCREW, mach, hex wash hd	6	72	16X363	LABEL, right side	1
7	105510	WASHER, lock, spring	2	77	16X203	CLIP, drain line	1
8	15E891	CLIP, retaining	2	83	24V089	HOUSING, bearing; <i>includes 7, 12, 14, 15, 31, 55, 56, 77, 108, 117, 180</i>	1
10	156306	WASHER, flat	2	84	258909	MOTOR, electric; <i>includes 125, 126, 127</i>	1
11	119509	WHEEL, pneumatic	2	85	24V086	ROD, connecting	1
12	112600	WASHER, lock (hi-collar)	4	87	241920	DEFLECTOR, threaded	1
14	17E790	SCREW, cap, socket head	4	89	288035	GEAR, combination; <i>includes 28, 30</i>	1
15	101550	SCREW, cap, sch	2	90	287990	HOUSING, drive; <i>includes 6, 36, 90a</i>	1
16	121311	FITTING, connector	1	90a	194173	WASHER, race, thrust	1
17	276974	CAP, leg	2	91	17H835	PUMP, displacement	1
18	260212	SCREW, hex washer, hd	2	93	244240	HOSE, drain; <i>includes 87</i>	1
19	102982	O-RING	1	94	24V029	KIT, Hose, cpld, 1/2 in.; <i>includes 19</i>	1
22	116038	WASHER, wave spring	2	105	16X698	HANGER, stand, cart	1
23	117791	SCREW, cap, tri lobe	2	106	15C982	CAM, cart	2
24	111040	NUT, lock, insert	4	107	114531	SCREW, mach, hex washer hd	4
28	114672	WASHER, thrust	2	108	16X209	PLATE, front, PCII, 7900	1
29	24M197	GUIDE, Hose, ultra platinum	1	110	17E925	LABEL, ProContractor Series	1
30	114699	WASHER, thrust	1	117	187437	LABEL, torque	1
31	118444	SCREW, mach, slot hex wash hd	5	123	276980	GROMMET, cover	2
35	117633	SCREW, slot hex wash hd	2	124	119250	SCREW, shoulder	3
36	116192	WASHER, thrust, 1595	1	125	15G845	SPACER, standoff	2
37	100057	SCREW, cap, hex hd	4	126	15V577	FAN, motor	1
39	16M441	TUBE, formed, ultra, plati- num	1	127	122347	RING, retaining	1
41	24U755	FITTING	1	128▲		TAG, WARNING (not shown)	1
41a	16N461	HOUSING, seat, check valve	1	222385		English, French, Spanish	
41b	16X837	HOUSING, ball, check valve	1	17A134		English, Chinese, Korean	
41c	24M725	KIT, repair, check valve; <i>includes 41d, 41e, 41f</i>	1	17R476		English, Spanish, Portuguese	
41d		O-RING	1	159	278075	BRACKET, wire	1
41e		SEAT	1	160	15Y118	LABEL, Made in the USA	1
41f		BALL	1	180	112746	NUT, lock, thin pattern	2
48	15V573	STRAINER, (1-11 1/2 npsm)	1				
51	24V025	COVER, drive, plastic, painted; <i>includes 31</i>	1				
55	16C457	HANGER, pail	1				
56	16X324	CLAMP, pump, large	1				
58	287282	SHIELD, motor, painted; <i>includes 123, 124</i>	1				
62	24Y426	FRAME, platinum, 1095/Mark V	1				

▲ Replacement safety labels, tags, and cards are available at no cost.

# 1095/1595/Mark V HD /Mark VII HD IronMan

## 1095/1595/Mark V HD /Mark VII HD IronMan Parts

Ref.	Torque
▲1	40-45 in-lb (4.5 - 5.0 N•m)
▲2	9-11 in-lb (1.0 - 1.2 N•m)
▲3	200-230 in-lb (22.6 - 25.9 N•m)
▲4	190-210 in-lb (21.4 - 23.7 N•m)
▲5	90-110 in-lb (10.1 - 12.4 N•m)
▲6	25-30 ft-lb (33.8 - 40.6 N•m)
▲7	65-85 in-lb (7.3 - 9.6 N•m)

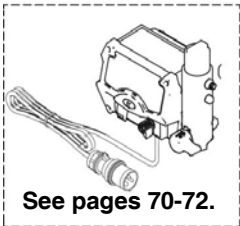
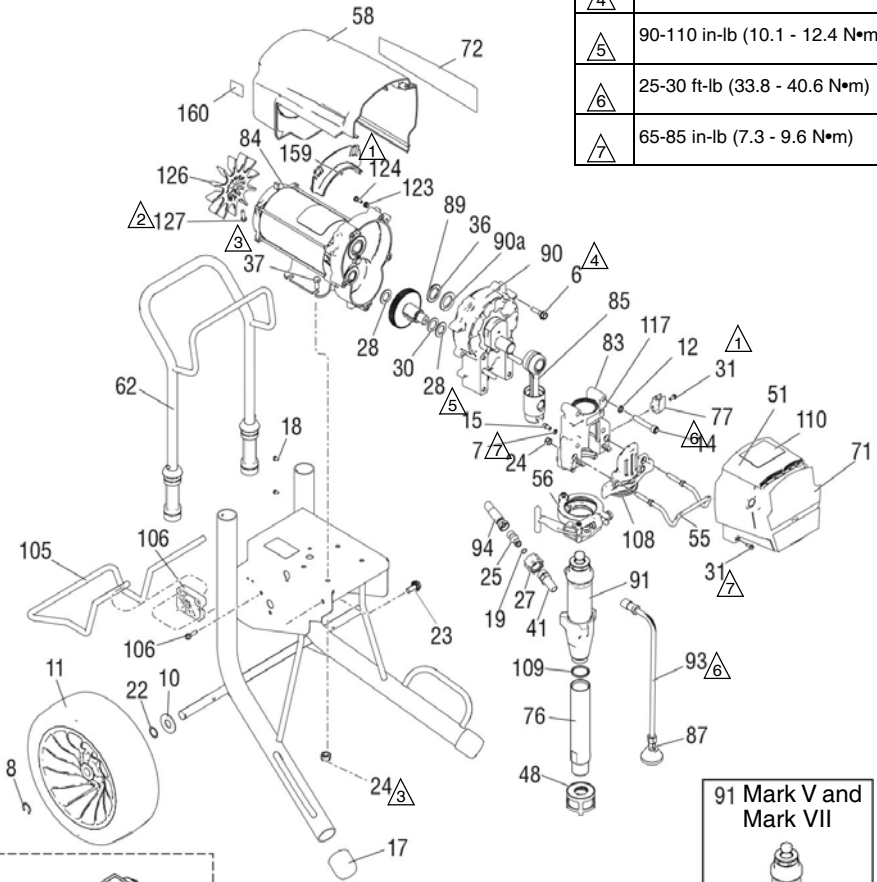

See pages 70-72.

ti34938a

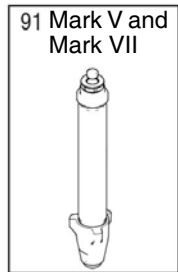

91 Mark V and Mark VII

# 1095/1595/Mark V HD /Mark VII HD IronMan

## 1095/1595/Mark V HD/Mark VII HD IronMan

Ref.	Part	Description	Qty.	Ref.	Part	Description	Qty.
6	15C753	SCREW, mach, torx, hex	5		17E748	Mark V	
7	105510	WASHER, lock, spring	2		17E750	Mark VII	
8	15E891	CLIP, retaining	2	76	248215	TUBE, intake; <i>includes 109</i>	1
10	156306	WASHER, flat	2	77	16X203	CLIP, drain line	1
11	17E687	WHEEL	2	83	24V088	HOUSING, bearing; <i>includes 7, 12, 14, 15, 24, 31, 55, 56, 77, 108, 117</i>	1
12	106115	WASH, lock, spring	4				
14	17E789	SCREW, cap, socket hd	4	84		MOTOR, electric; <i>includes 126, 127</i>	1
15	101550	SCREW, cap, sch	2		257187	1095/Mark V 230V	
17	276974	CAP, leg	2		257188	1595/Mark V 120V/Mark VII	
19		PACKING, o-ring	1		85	24V085	ROD, connecting
	107505	1095/1595		87	241920	DEFLECTOR, threaded	1
	102982	Mark V/Mark VII		89	287290	GEAR, combination; <i>includes 28, 30</i>	1
22	116038	WASHER, wave spring	2	90		HOUSING, drive <i>includes 6, 36, 90a</i>	1
23	117791	SCREW, cap, flng hd	2		24M417	Mark VII	
24	111040	NUT, lock, insert	6		287294	1095 120V	
25	16X833	FITTING, QD, 3/8 npsm, 1095/1595	1		287295	1095 230V/1595/Mark V	
27	120583	NUT, hand, 1095/1595	6	90a	194173	WASHER, race, thrust	1
28	114672	WASHER, thrust	2	91		PUMP, displacement	1
30	114699	WASHER, thrust	1		17H826	1095/1595; <i>includes 41, 109</i>	
31	118444	SCREW, machine, hex washer hd	8		17H836	Mark V; <i>includes 41</i>	
36	116192	WASHER, thrust	1		17H892	Mark VII	
37	100057	SCREW, cap, hex hd	4	93	244240	HOSE, drain; <i>includes 87</i>	1
41		FITTING, pump, QD	1	94		HOSE, coupled 3/8 x 15.75	1
	16Y579	1095/1595			16X904	1095/1595	
	16X834	Mark V/Mark VII			24V029	Mark V/Mark VII; <i>includes 19</i>	
48	15V573	STRAINER, (1-11 1/2 NPSM)	1	108	16X385	PLATE, front, 5900, PClI	
51	24V024	COVER, drive, plastic, painted; <i>includes 31</i>	1	109	118494	PACKING, o-ring	1
55	16C457	HANGER, pail	1	110		LABEL, IronMan series	1
56	16X324	CLAMP, pump, large	1		17E926	Ultra/Mark	
58	287282	SHIELD, motor, painted; <i>includes 123, 124</i>	1		17G989	Ultimate	
62	24Y428	FRAME, cart, 1095/1595	1	117	187437	LABEL, torque	1
71		LABEL, UltraMax	1	123	276980	GROMMET, cover	2
	17E732	Ultra 1095		124	119250	SCREW, shoulder, hex, washer	3
	17E734	Ultra 1595		126	15D088	FAN, motor	1
	17E740	Ultimate 1095		127	115477	SCREW, mach, torx, pan, hd	1
	17E742	Ultimate 1595		128▲		TAG, WARNING (not shown)	1
	17E747	Mark V			222385	English, French, Spanish	
	17E749	Mark VII			17A134	English, Chinese, Korean	
72		LABEL, UltraMax II, 1095/1595	1		17R476	English, Spanish, Portuguese	
	17E733	Ultra 1095		159	278075	BRACKET, wire	1
	17E735	Ultra 1595		160	15Y118	LABEL, Made in USA	1
	17E741	Ultimate 1095					
	17E743	Ultimate 1595					

▲ Replacement safety labels, tags, and cards are available at no cost.

# Mark X HD IronMan Parts

## Mark X HD IronMan Parts

Ref.	Torque
①	40-45 in-lb (4.5 - 5.0 N•m)
②	55-60 in-lb (6.2 - 6.7 N•m)
③	200-230 in-lb (22.6 - 25.9 N•m)
④	190-210 in-lb (21.4 - 23.7 N•m)
⑤	22-28 in-lb (2.4 - 3.1 N•m)
⑥	25-30 ft-lb (33.8 - 40.6 N•m)
⑦	130-150 in-lb (14.6 - 16.9 N•m)
⑧	90-110 in-lb (10.1 - 12.4 N•m)
⑨	65-85 in-lb (7.3 - 9.6 N•m)

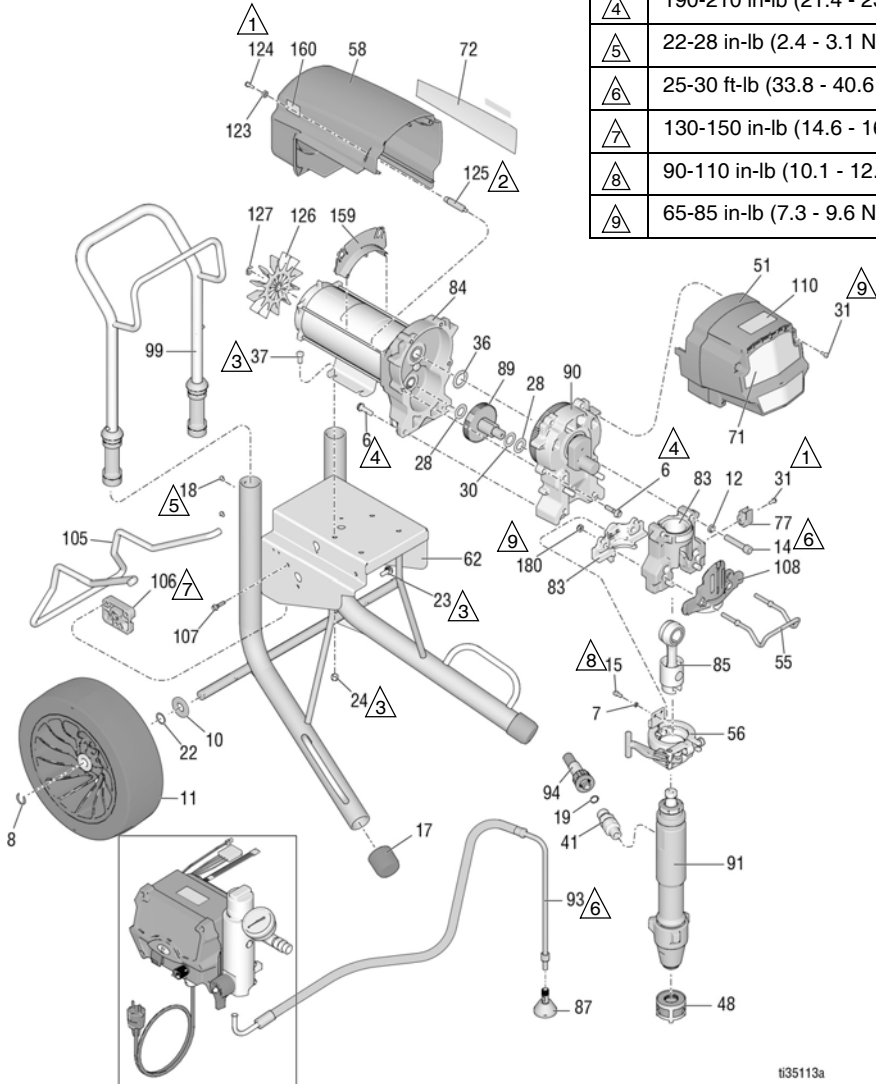

See pages 70-72.

t135113a

## Mark X HD IronMan Parts List

Ref.	Part	Description	Qty.	Ref.	Part	Description	Qty.
6	15C753	SCREW, mach, torx, hex	6	84	258909	MOTOR, electric; <i>includes 125, 126, 127</i>	1
7	105510	WASHER, lock, spring	2	85	24V086	ROD, connecting	1
8	15E891	CLIP, retaining	2	87	241920	DEFLECTOR, threaded	1
10	156306	WASHER, flat	2	89	288035	GEAR, combination; <i>includes 28, 30</i>	1
11	17E687	WHEEL	2	90	287990	HOUSING, drive; includes 6, 36, 90a	1
12	112600	WASHER, lock, spring	4	91	17H837	PUMP, displacement	1
14	17E790	SCREW, cap, socket hd	4	93	244240	HOSE, drain; includes 87	1
15	101550	SCREW, cap, sch	2	94	24V029	KIT, Hose, cpld, 1/2 in.; <i>includes 19</i>	1
17	276974	CAP, leg	2	99	24A250	HANDLE, cart	1
18	108795	SCREW, pnh	4	105	16X696	HANGER, stand, cart	1
19	102982	PACKING, o-ring	1	106	15C982	CAM, cart	2
22	116038	WASHER, wave spring	2	107	114531	SCREW, mach, hex washer hd	4
23	117791	SCREW, cap, flng hd	2	108	16X209	PLATE, front, PCII, 7900	1
24	111040	NUT, lock, insert	4	110	17E926	LABEL, IronMan series	1
28	114672	WASHER, thrust	2	123	276980	GROMMET, cover	2
30	114699	WASHER, thrust	1	124	119250	SCREW, shoulder, hex, washer	3
31	118444	SCREW, mach, slot hex wash hd	5	125	15G845	SPACER, standoff	2
36	116192	WASHER, thrust	1	126	15V577	FAN, motor	1
37	100057	SCREW, cap, hex hd	4	127	122347	RING, retaining	1
41	24U755	FITTING, pump, QD	1	128▲		TAG, WARNING (not shown)	1
48	15V573	STRAINER, (1-11 1/2 NPSM)	1		222385	English, French, Spanish	
51	24V025	COVER, drive, plastic, painted; <i>includes 31</i>	1		17A134	English, Chinese, Korean	
55	16C457	HANGER, pail	1		17R476	English, Spanish, Portuguese	
56	16X324	CLAMP, pump, large	1	159	278075	BRACKET, wire	1
58	287282	SHIELD, motor, painted; <i>includes 123, 124</i>	1	160	15Y118	LABEL, Made in USA	1
62	24Y428	FRAME, cart	1	180	112746	NUT, lock, thin pattern	2
71	17E751	LABEL, front	1				
72	17E752	LABEL, side	1				
77	16X203	CLIP, drain line	1				
83	24V089	HOUSING, bearing; <i>includes 7, 12, 14, 15, 31, 55, 56, 77, 108, 117, 180</i>	1				

▲ Replacement safety labels, tags, and cards are available at no cost.

## ProContractor QuikReel

Ref.	Torque
△1	130-150 in-lb (14.6 - 16.9 N•m)
△2	25-35 ft-lb (33.8 - 47.4 N•m)
△3	120-130 in-lb (13.5 - 14.6 N•m)
△4	38-42 ft-lb (51.5 - 56.9 N•m)

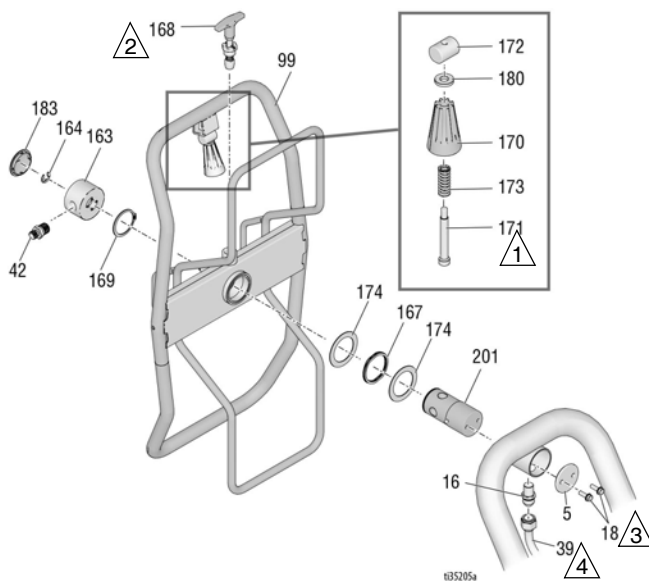

## QuikReel Parts List

Ref.	Part	Description	Qty.	Ref.	Part	Description	Qty.
5	16C975	PLATE, Pivot Mount	1	99	24B691	REEL, Hose, ultra	1
16	121311	FITTING, Connector, NPT x JIC	1	163	24B248	CAP, swivel, complete	1
18	260212	SCREW, Hex Washer HD	2	164	122347	RING, retaining, external	1
39		TUBE, Formed, Ultra, Platinum	1	167	122534	SPRING, wave	1
	24V095	695/795 Models		168	24E400	PIN, pop, lock out	1
	24J081	1095/Mark V Models		169	122524	RING, retaining, external	1
	16M441	Mark X		170	278085	HANDLE, swivel	1
42		ADAPTER	1	171	122518	PIN	1
	164672	695/795/1095/1595		172	15X618	NUT, pin	1
	196178	Mark IV/Mark V		173	122542	SPRING	1
	159239	Mark VII/Mark X		174	122607	WASHER, flat	2
				180	122669	WASHER	1
				183	122787	CAP	1
				201	24E016	TUBE, Hose Reel, Pivot	1



## Spray Gun and Hose

695-1595 Models



t34939b

Mark IV-Mark VII Models

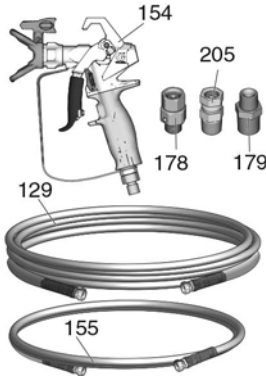

Mark X Models

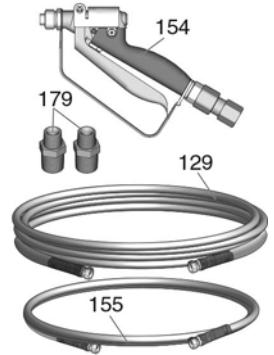

## Spray Gun and Hose Parts List

Ref. Part	Description	Qty.	Ref. Part	Description	Qty.
129	HOSE, coupled		246468	Mark IV	1
240794	Ultra, 1/4" x 50'	1	245820	Mark X	1
826079	Ultimate, 1/4" x 50'	1	155	HOSE, whip	
245225	Mark IV/Mark V, 3/8" x 50'	1	241735	Mark IV/Mark V, 1/4" x 3'	1
278499	Mark VII/Mark X, 1/2" x 50'	1	191239	Mark VII/Mark V, 3/8" x 11'	1
154	SPRAY GUN		178	189018 SWIVEL	1
17Y042	Ultra, North America	1	179	BUSHING	
17Y044	Ultra, Asia		110476	Mark IV/Mark V	1
17Y043	Ultra, Europe		159239	Mark VII	1
826252	695/795/1095/1595 Ultimate	1	159239	Mark X	2
241705	Mark V/Mark VII	1	205	110476 ADAPTER (Mark VII only)	1

## Filter

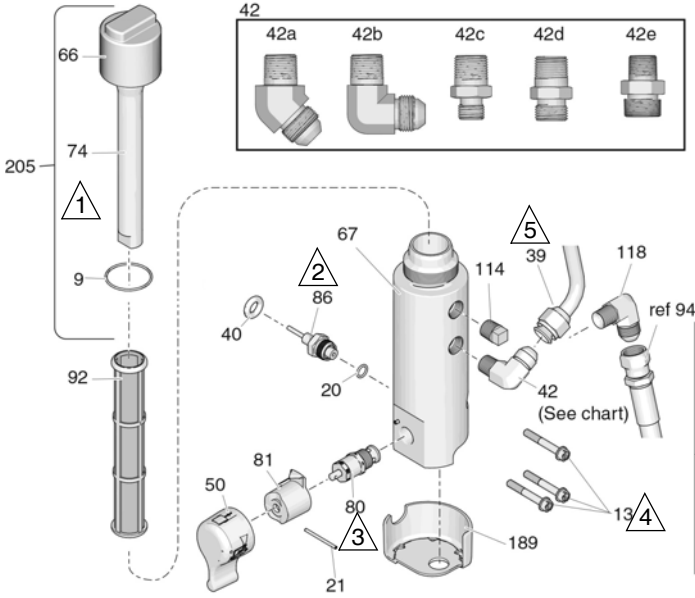

Ref.	Torque
1	90-110 in-lb (10.1 - 12.4 N•m)
2	35-45 ft-lb (47.4 - 61.0 N•m)
3	190-210 in-lb (21.4 - 23.7 N•m)
4	100-120 in-lb (11.2 - 13.5 N•m)
5	38-42 ft-lb (51.5 - 56.9 N•m)
6	15-25 in-lb (1.6 - 2.8 N•m)
7	365-385 in-lb (41.2 - 43.5 N•m)

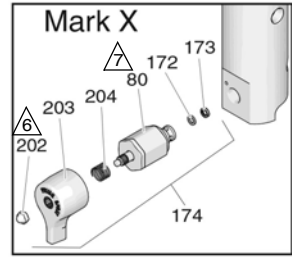







t22913d

# Filter Parts List

Ref. Part	Description	Qty.	Ref. Part	Description	Qty.
9	117285 PACKING, o-ring	1	244071	30 mesh	
13	16U013 SCREW, cap, socket head	3	244067	60 mesh, original equipment	
20	111457 PACKING, o-ring	1	244068	100 mesh	
21	15C972 PIN, grooved	1	244069	200 mesh	
39	TUBE, formed	1	114 104813	PLUG, pipe, 3/8	1
	24V095 695/795 Models		118 125926	FITTING, elbow	1
	24J081 1095/Mark V Models		172 193709	SEAT, valve	1
	16M441 Mark X		173 193710	SEAL, seat, valve	1
40	121889 GROMMET, transducer	1	174 245103	KIT, repair, valve, Mark X; <i>includes 80, 172, 173, 202, 203, 204</i>	1
42	FITTING		189 17A197	GUARD, base, filter (ProCon- tractor/IronMan Series)	
42a	122533 1095/1595/Mark V/Mark VII (ProContractor series)	1	202 116424	NUT, Mark X	1
42b	125926 695/795/Mark IV/Mark X (ProContractor series)	1	203 15G563	HANDLE, valve, Mark X	1
42c	164672 695/795/1095/1595 (Stan- dard and IronMan series)	1	204 114708	SPRING, compression, Mark X	1
42d	196178 Mark IV/Mark V (Standard and IronMan Series)	1	205 287285	KIT, repair, cap, filter <i>includes 9, 66, 74</i>	
42e	183285 Mark VII/Mark X (Standard and IronMan Series)	1	206 115523	GAUGE, pressure (not shown)	1
50	KIT, handle; <i>includes 21, 81</i>	1	207	FITTING, tee swivel (not shown)	
	24E234 Standard Series		119783	695/795/1095/1595	1
66	17E680 CAP, filter	1	127518	Mark IV, Mark V, Mark VII, Mark X	1
67	16T543 BASE, filter	1	208	FITTING (not shown)	
74	15C766 TUBE, diffusion	1	162453	695/795/1095/1595	1
80	24B156 VALVE, prime, HD	1	196178	Mark IV, Mark V	1
	287879 VALVE, prime, Mark X	1	183285	Mark VII, Mark X	1
81	BASE, valve	1			
	24A382 Standard series				
86	243222 TRANSDUCER, pressure control; <i>includes 20</i>	1			
92	FILTER, fluid	1			

## Control

Ref.	Torque	Ref.	Torque
 1	10-15 in-lb (1.1 - 1.7 N•m)	 4	30-35 in-lb (3.3 - 3.9 N•m)
 2	40-45 in-lb (4.5 - 5.0 N•m)	 5	15-20 in-lb (1.7 - 2.2 N•m)
 3	200-230 in-lb (22.6 - 25.9 N•m)	 6	2-3 in-lb (0.2 - 0.4 N•m)

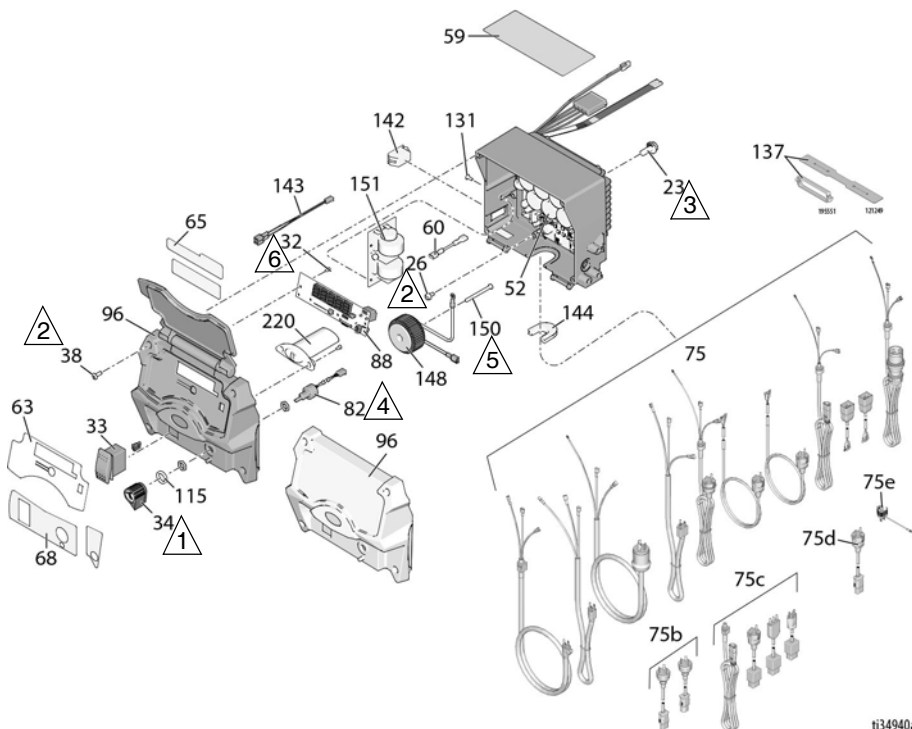

ti34940a

## Control Box Parts List

Ref. Part	Description	Qty.	Ref. Part	Description	Qty.
23	117791 SCREW, cap, flange head	2	75e	244285 Japan	1
26	114391 SCREW, grounding	1	75f	India	1
32	115522 SCREW, mach, pnh (ProContractor/IronMan series)	3	17N232	695/796/1095/Mark IV/Mark V	1
33	116752 SWITCH, rocker, ON/OFF	1	82	256219 POTENTIOMETER, assembly	1
	15D527 SWITCH, rocker, Mark X	1	88	16Y496 DISPLAY	1
34	116167 KNOB, potentiometer	1	96	COVER, control	1
38	16V095 SCREW, #10, taptite phil	4	17H886	With Display; <i>includes 32, 38, 63, 65, 68, 88, 196</i>	1
52*	CONTROL, board with battery <i>includes 23, 26, 60, 131, 142, 144</i>	1	17H887	Without Display; <i>includes 38, 63, 68, 196</i>	1
	25N545 120V Models		115	15C973 GASKET	1
	25N546 240V Models		131	16T482 RIVET, snap	2
59▲	LABEL, warning	1	137	RETAINER, plug adapter	1
	16T784 North America	1	195551	695/795/1095/Mark IV/Mark V	1
	15G596 Europe	1	121249	Mark VII/Mark X Models	1
	16Y762 ANZ / Korea	1	142	SWITCH/PLUG	1
	16Y761 Japan	1	16T483	695/795/1095/Mark IV/Mark X, North America (plug)	1
	26A970 Hindi / Indonesia	1	126029	Mark VII/Mark X Models (10/16 amp)	1
60	16T541 JUMPER WIRE	1	120059	1595/Mark V 120V (15/20 amp)	1
63	17E725 LABEL, control box cover, ultra (with display)	1	143	15G935 CONNECTOR, electrical (1595/Mark V)	1
	17E726 LABEL, control box cover, ultra (without display)	1	144	STRAIN RELIEF	1
65	17E724 LABEL, lid, Ultra (with display)	1	16T546	695/795/1095/Mark IV/Mark V International Models	1
68	17E723 LABEL, control	1	16T547	695/795/1095/Mark V, Domestic Models	1
	16Y786 LABEL, control (Standard series)	1	16T547	695/795/1095, Japanese Models	1
75	CORD, power	1	16T544	Mark VII/Mark X International Models	1
	17E804 120V Models, 695, 795, 1095, Mark IV	1	116171	1595/Mark V/Mark X, North American Models	1
	17E804 Japanese Models 695, 795, 1095	1	116171	Mark V Japanese Models	1
	17E805 120V Models, 1595, Mark V	1	145	117745 BUSHING, strain relief (Mark VII/Mark X, International Models)	1
	17E805 Japanese Models, Mark V	1	148	24V030 KIT, repair, coil; <i>includes 150</i>	1
	17E806 Mark X NEMA L6-30	1	150	16U215 SCREW, machine, flat head	1
	17E807 120V CSA Models, 1595, Mark V	1	151	BOARD, filter	1
	17E808 EU CEE 7/7	1	25N516	230V International Models	1
	17E809 Mark VII EU CEE 7/7	1	25N517	110V International Models	1
	17E810 Mark X EU CEE 7/7	1	25N518	Mark X International Models	1
	17E811 EU Multicord	1	220	17Y277 GUIDE, light, BlueLink	1
	17E812 Mark VII Multicord	1			
	17E813 Mark X Multicord	1			
	17E814 UK	1			
75b	China/Australia				
	242005 695/795/1095/Mark IV/Mark V	1			
	17A242 Mark X	1			
75c	Italy/Denmark/Switzerland				
	287121 695/795/1095/Mark IV/Mark V	1			
	253103 Mark VII/Mark X Models	1			
75d	242001 EU CEE 7/7	1			

\* Use battery CR2032

▲ Replacement safety labels, tags, and cards are available at no cost.

## Wiring Diagrams

### 695-1595/Mark IV HD-V HD 120V Models

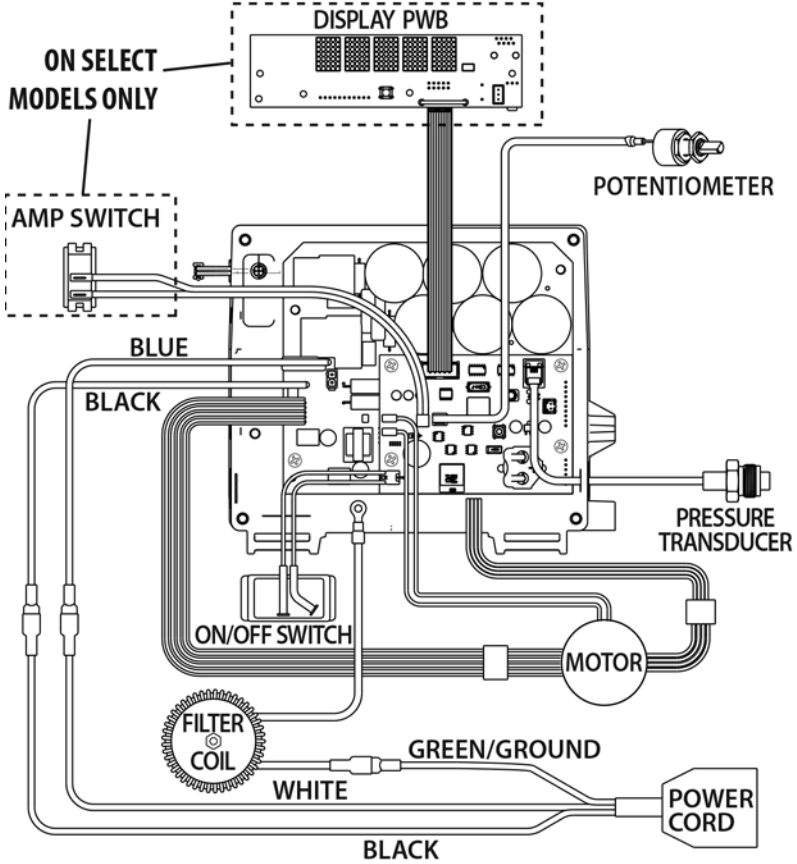

t34657a

## 695-1095/Mark IV HD-VII HD 110V/230V Models

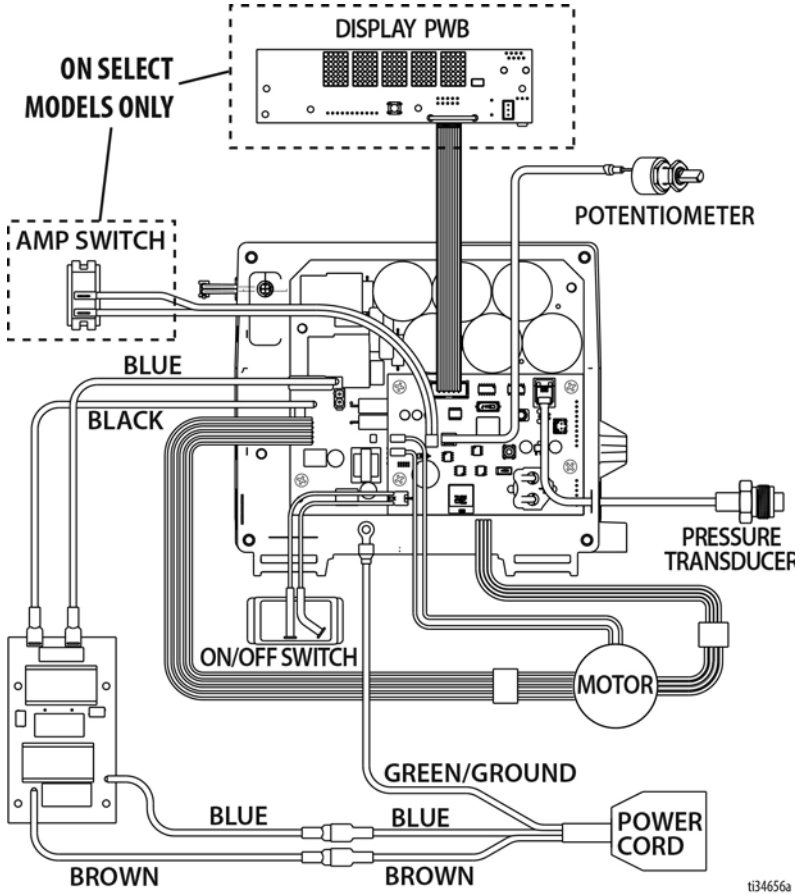

t134656a

# Wiring Diagrams

## Mark X HD (North

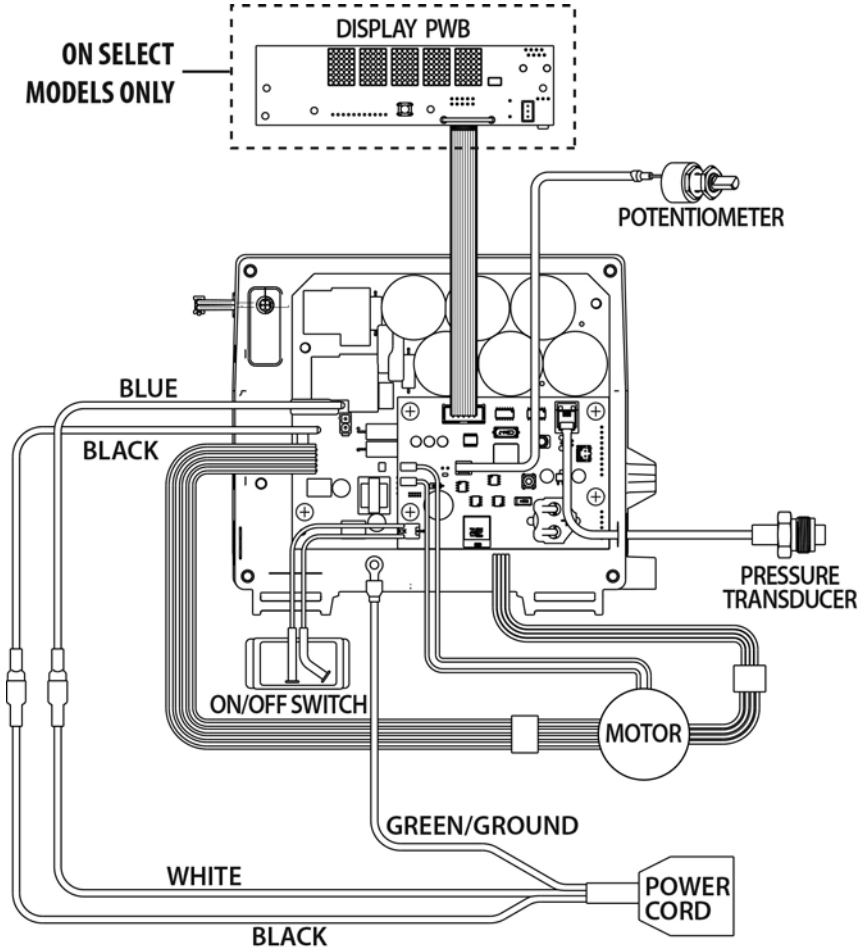

ti34564a

America)



## Mark X HD (International)

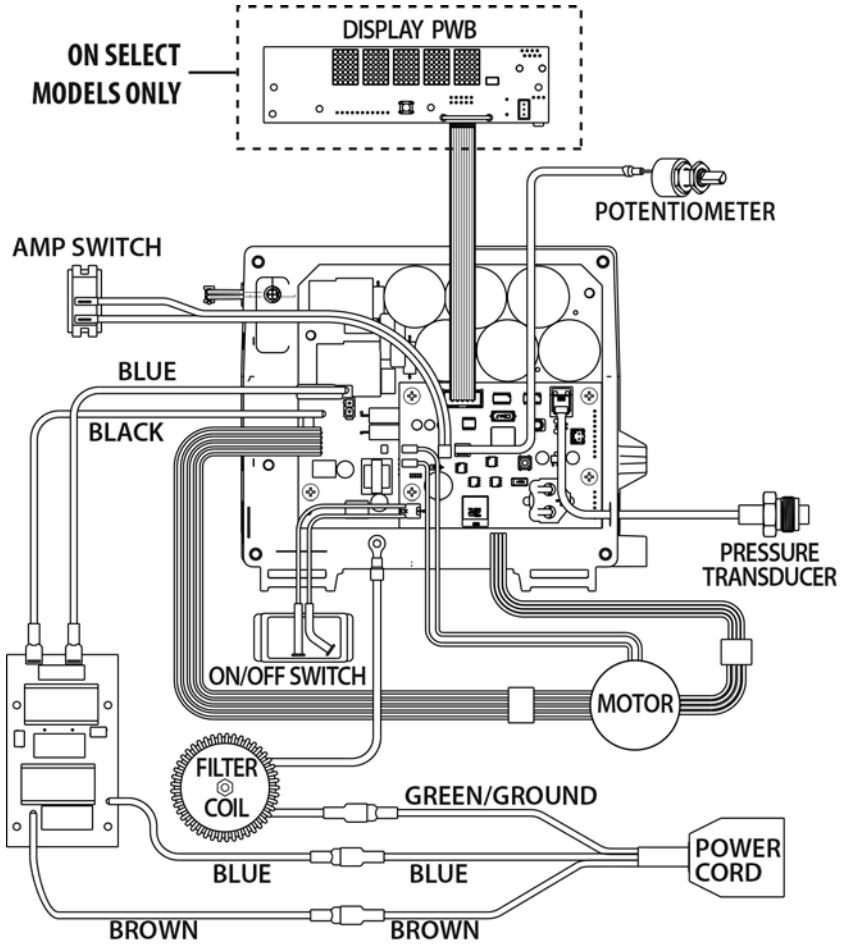

t34565a

## Technical Specifications

<b>695 Sprayers</b>		
	<b>U.S.</b>	<b>Metric</b>
<b>Sprayer</b>		
Maximum Delivery	0.95 gpm	3.6 lpm
Maximum Tip Size	0.031	0.031
Fluid Outlet npsm	1/4 in.	1/4 in.
Cycles	226 per gallon	60 per liter
Generator Minimum	5000 W	5000 W
120V, A, Hz	15, 50/60	
230V, A, Hz	10, 50/60	
<b>Dimensions</b>		
<b>Weight:</b>		
Standard Series Lo-Boy	94 lb	43 kg
Standard Series Hi-Boy	93 lb	42 kg
ProContractor Series	103 lb	47 kg
<b>Height:</b>		
Standard Series Lo-Boy	27.5 in.	69.9 cm
Standard Series Hi-Boy	28.5 in. (Handle down) 38.75 in. (Handle up)	72.4 cm (Handle down) 98.4 cm (Handle up)
ProContractor Series	39 in.	99 cm
<b>Length:</b>		
Standard Series Lo-Boy	37 in.	94 cm
Standard Series Hi-Boy	26 in.	66 cm
ProContractor Series	29.5 in.	75 cm
<b>Width:</b>	22.5 in.	57.2 cm
<b>Wetted parts</b>		
	zinc- and nickel-plated carbon steel, nylon, stainless steel, PTFE, Acetal, leather, UHMWPE, aluminum, tungsten carbide, PEEK, brass	
<b>Noise Level:</b>		
Sound Power	91 dBa*	91 dBa*
Sound Pressure	82 dBa*	82 dBa*
	*per ISO 3744; measured at 3.1 ft	*per ISO 3744; measured at 1 m

## 795 Sprayers

	U.S.	Metric
<b>Sprayer</b>		
Maximum Delivery	1.1 gpm	4.2 lpm
Maximum Tip Size	0.033	0.033
Fluid Outlet npsm	1/4 in.	1/4 in.
Cycles	195 per gallon	52 per liter
Generator Minimum	5000 W	5000 W
120V, A, Hz	15, 50/60	
230V, A, Hz	10, 50/60	
<b>Dimensions</b>		
<b>Weight:</b>		
Standard Series Lo-Boy	98 lb	45 kg
Standard Series Hi-Boy	97 lb	44 kg
ProContractor Series	107 lb	49 kg
<b>Height:</b>		
Standard Series Lo-Boy	27.5 in.	69.9 cm
Standard Series Hi-Boy	28.5 in. (Handle down) 38.75 in. (Handle up)	72.4 cm (Handle down) 98.4 cm (Handle up)
ProContractor Series	39 in.	99 cm
<b>Length:</b>		
Standard Series Lo-Boy	37 in.	94 cm
Standard Series Hi-Boy	26 in.	66 cm
ProContractor Series	29.5 in.	75 cm
<b>Width:</b>		
	22.5 in.	57.2 cm
<b>Wetted parts</b>		
	zinc- and nickel-plated carbon steel, nylon, stainless steel, PTFE, Acetal, leather, UHMWPE, aluminum, tungsten carbide, PEEK, brass	
<b>Noise Level:</b>		
Sound Power	91 dBa*	91 dBa*
Sound Pressure	82 dBa*	82 dBa*
	*per ISO 3744; measured at 3.1 ft	*per ISO 3744; measured at 1 m

# Technical Specifications

## 1095 Sprayers

	U.S.	Metric
<b>Sprayer</b>		
Maximum Delivery	1.2 gpm	4.5 lpm
Maximum Tip Size	0.035	0.035
Fluid Outlet npsm	1/4 in.	1/4 in.
Cycles	123 per gallon	33 per liter
Generator Minimum	5000 W	5000 W
120V, A, Hz	15, 50/60	
230V, A, Hz	10, 50/60	
<b>Dimensions</b>		
<b>Weight:</b>		
Standard Series	116 lb	53 kg
ProContractor Series	131 lb	59 kg
IronMan Series	120 lb	54 kg
<b>Height:</b>		
Standard and IronMan Series	29.5 in. (Handle down) 38.5 in. (Handle up)	74.9 cm (Handle down) 97.8 cm (Handle up)
ProContractor Series	39 in.	99 cm
<b>Length:</b>		
Standard and IronMan Series	26 in.	66 cm
ProContractor Series	28 in.	71 cm
<b>Width:</b>	24 in.	61 cm
<b>Wetted parts</b>		
	zinc- and nickel-plated carbon steel, nylon, stainless steel, PTFE, Acetal, leather, UHMWPE, aluminum, tungsten carbide, PEEK, brass	
<b>Noise Level:</b>		
Sound Power	91 dBa*	91 dBa*
Sound Pressure	82 dBa*	82 dBa*
	*per ISO 3744; measured at 3.1 ft	*per ISO 3744; measured at 1 m

## 1595 Sprayers

	U.S.	Metric
<b>Sprayer</b>		
Maximum Delivery	1.35 gpm	5.1 lpm
Maximum Tip Size	0.039	0.039
Fluid Outlet npsm	1/4 in.	1/4 in.
Cycles	110 per gallon	29 per liter
Generator Minimum	5000 W	5000 W
120V, A, Hz	20, 50/60	
<b>Dimensions</b>		
<b>Weight:</b>		
Standard Series	124 lb	56 kg
ProContractor Series	138 lb	63 kg
IronMan Series	128 lb	28 kg
<b>Height:</b>		
Standard and IronMan Series	29.5 in. (Handle down) 38.5 in. (Handle up)	74.9 cm (Handle down) 97.8 cm (Handle up)
ProContractor Series	39 in.	99 cm
<b>Length:</b>		
Standard and IronMan Series	26 in.	66 cm
ProContractor Series	28 in.	71 cm
<b>Width:</b>		
Standard and IronMan Series	24 in.	61 cm
ProContractor Series	24 in.	61 cm
<b>Wetted parts</b>		
	zinc- and nickel-plated carbon steel, nylon, stainless steel, PTFE, Acetal, leather, UHMWPE, aluminum, tungsten carbide, PEEK, brass	
<b>Noise Level:</b>		
Sound Power	91 dBa*	91 dBa*
Sound Pressure	82 dBa*	82 dBa*
	*per ISO 3744; measured at 3.1 ft	*per ISO 3744; measured at 1 m

# Technical Specifications

## Mark IV HD Sprayers

	U.S.	Metric
<b>Sprayer</b>		
Maximum Delivery	1.1 gpm	4.2 lpm
Maximum Tip Size		
North American Models	0.033	0.033
International Models	0.031	0.031
Fluid Outlet npsm	3/8 in.	3/8 in.
Cycles	195 per gallon	52 per liter
Generator Minimum	5000 W	5000 W
120V, A, Hz	15, 50/60	
230V, A, Hz	10, 50/60	
<b>Dimensions</b>		
<b>Weight:</b>		
Standard Series	101 lb	46 kg
ProContractor Series	109 lb	49 kg
<b>Height:</b>		
Standard Series	28.5 in. (Handle down) 38.75 in. (Handle up)	72.4 cm (Handle down) 98.4 cm (Handle up)
ProContractor Series	39 in.	99 cm
<b>Length:</b>		
Standard Series	26 in.	66 cm
ProContractor Series	29.5 in.	75 cm
<b>Width:</b>		
	22.5 in.	57.2 cm
Wetted parts		
	zinc- and nickel-plated carbon steel, nylon, stainless steel, PTFE, Acetal, leather, UHMWPE, aluminum, tungsten carbide, PEEK, brass	
Noise Level:		
Sound Power	91 dBa*	91 dBa*
Sound Pressure	82 dBa*	82 dBa*
	*per ISO 3744; measured at 3.1 ft	*per ISO 3744; measured at 1 m

## Mark V HD Sprayers

	U.S.	Metric
<b>Sprayer</b>		
Maximum Delivery	1.35 gpm	5.1 lpm
Maximum Tip Size		
North American and UK Models	0.039	0.039
International Models	0.035	0.035
Fluid Outlet npsm	3/8 in.	3/8 in.
Cycles	110 per gallon	29 per liter
Generator Minimum	5000 W	5000 W
120V, A, Hz	20, 50/60	
230V, A, Hz	10, 50/60	
<b>Dimensions</b>		
<b>Weight:</b>		
Standard Series	125 lb	57 kg
ProContractor Series	141 lb	64 kg
IronMan Series	129 lb	59 kg
<b>Height:</b>		
Standard and IronMan Series	29.5 in. (Handle down) 38.5 in. (Handle up)	74.9 cm (Handle down) 97.8 cm (Handle up)
ProContractor Series	39 in.	99 cm
<b>Length:</b>		
Standard and IronMan Series	26 in.	66 cm
ProContractor Series	28 in.	71 cm
<b>Width:</b>	24 in.	61 cm
<b>Wetted parts</b>		
	zinc- and nickel-plated carbon steel, nylon, stainless steel, PTFE, Acetal, leather, UHMWPE, aluminum, tungsten carbide, PEEK, brass	
<b>Noise Level:</b>		
Sound Power	91 dBa*	91 dBa*
Sound Pressure	82 dBa*	82 dBa*
	*per ISO 3744; measured at 3.1 ft	*per ISO 3744; measured at 1 m

# Technical Specifications

## Mark VII HD Sprayers

	U.S.	Metric
<b>Sprayer</b>		
Maximum Delivery	1.58 gpm	6.0 lpm
Maximum Tip Size	0.041 in.	0.041 in.
Fluid Outlet npsm	1/2 in.	1/2 in.
Cycles	97 per gallon	26 per liter
Generator Minimum	5000 W	5000 W
230V, A, Hz	16, 50/60	
<b>Dimensions</b>		
<b>Weight:</b>		
Standard Series	132 lb	60 kg
ProContractor Series	148 lb	67 kg
IronMan Series	136 lb	62 kg
<b>Height:</b>		
Standard and IronMan Series	29.5 in. (Handle down) 38.5 in. (Handle up)	74.9 cm (Handle down) 97.8 cm (Handle up)
ProContractor Series	39 in.	99 cm
<b>Length:</b>		
Standard and IronMan Series	26 in.	66 cm
ProContractor Series	28 in.	71 cm
<b>Width:</b>	24 in.	61 cm
Wetted parts		
	zinc- and nickel-plated carbon steel, nylon, stainless steel, PTFE, Acetal, leather, UHMWPE, aluminum, tungsten carbide, PEEK, brass	
<b>Noise Level:</b>		
Sound Power	91 dBa*	91 dBa*
Sound Pressure	82 dBa*	82 dBa*
	*per ISO 3744; measured at 3.1 ft	*per ISO 3744; measured at 1 m



## Mark X HD Sprayers

	U.S.	Metric
<b>Sprayer</b>		
Maximum Delivery	2.1 gpm	8.0 lpm
Maximum Tip Size	0.045 in.	0.045 in.
Fluid Outlet npsm	1/2 in.	1/2 in.
Cycles	70 per gallon	19 per liter
Generator Minimum	5000 W	5000 W
230V, A, Hz	16, 50/60	
<b>Dimensions</b>		
<b>Weight:</b>		
Standard Series	150 lb	68 kg
ProContractor Series	166 lb	75 kg
IronMan Series	154 lb	70 kg
<b>Height:</b>		
Standard and IronMan Series	29.9 in. (Handle down) 40.1 in. (Handle up)	76 cm (Handle down) 102 cm (Handle up)
ProContractor Series	39 in.	99 cm
<b>Length:</b>		
Standard and IronMan Series	26 in.	66 cm
ProContractor Series	30 in.	75 cm
<b>Width:</b>	24 in.	61 cm
<b>Wetted parts</b>		
	zinc- and nickel-plated carbon steel, nylon, stainless steel, PTFE, Acetal, leather, UHMWPE, aluminum, tungsten carbide, PEEK, brass	
<b>Noise Level:</b>		
Sound Power	91 dBa*	91 dBa*
Sound Pressure	82 dBa*	82 dBa*
	*per ISO 3744; measured at 3.1 ft	*per ISO 3744; measured at 1 m

All trademarks or registered trademarks are the property of their respective owners.

## Compliance

### Radio Frequency Approvals

Transmitter Frequency (all models): 2.4GHz  
Transmitter Power (all models): +8dBm





**NOTE:** FCC/IC Notice (all models)  
Contains FCC ID: QOQBGM13P  
Contains IC: 5123A-BGM13P

The enclosed device complies with Part 15 of the FCC Rules and with Industry Canada license-exempt RSS standard(s). Operation is subject to the following two conditions:(1) this device may not cause harmful interference and (2) this device must accept any interference received, including interference that may cause undesired operation.

Changes or modifications not expressly approved by the party responsible for compliance could void the user's authority to operate the equipment.

This equipment is not granted protection against harmful interference and cannot cause interference on systems properly authorized.

This equipment has the board BGM13P22A with homologation code ANATEL 01330-19-03402.

				
			<b>R-R-CE8-AR0573A R-R-CE8-AR1050A R-R-CE8-AR1050B R-R-CE8-AR1050C R-R-CE8-AR1050D R-C-BGT-BGM13P22</b>	

### California Proposition 65



**WARNING:** This product can expose you to chemicals known to the State of California to cause cancer and birth defects or other reproductive harm. For more information go to [www.P65Warnings.ca.gov](http://www.P65Warnings.ca.gov).

## Graco Standard Warranty

Graco warrants all equipment referenced in this document which is manufactured by Graco and bearing its name to be free from defects in material and workmanship on the date of sale to the original purchaser for use. With the exception of any special, extended, or limited warranty published by Graco, Graco will, for a period of twelve months from the date of sale, repair or replace any part of the equipment determined by Graco to be defective. This warranty applies only when the equipment is installed, operated and maintained in accordance with Graco's written recommendations.

This warranty does not cover, and Graco shall not be liable for general wear and tear, or any malfunction, damage or wear caused by faulty installation, misapplication, abrasion, corrosion, inadequate or improper maintenance, negligence, accident, tampering, or substitution of non-Graco component parts. Nor shall Graco be liable for malfunction, damage or wear caused by the incompatibility of Graco equipment with structures, accessories, equipment or materials not supplied by Graco, or the improper design, manufacture, installation, operation or maintenance of structures, accessories, equipment or materials not supplied by Graco.

This warranty is conditioned upon the prepaid return of the equipment claimed to be defective to an authorized Graco distributor for verification of the claimed defect. If the claimed defect is verified, Graco will repair or replace free of charge any defective parts. The equipment will be returned to the original purchaser transportation prepaid. If inspection of the equipment does not disclose any defect in material or workmanship, repairs will be made at a reasonable charge, which charges may include the costs of parts, labor, and transportation.

**THIS WARRANTY IS EXCLUSIVE, AND IS IN LIEU OF ANY OTHER WARRANTIES, EXPRESS OR IMPLIED, INCLUDING BUT NOT LIMITED TO WARRANTY OF MERCHANTABILITY OR WARRANTY OF FITNESS FOR A PARTICULAR PURPOSE.**

Graco's sole obligation and buyer's sole remedy for any breach of warranty shall be as set forth above. The buyer agrees that no other remedy (including, but not limited to, incidental or consequential damages for lost profits, lost sales, injury to person or property, or any other incidental or consequential loss) shall be available. Any action for breach of warranty must be brought within two (2) years of the date of sale.

**GRACO MAKES NO WARRANTY, AND DISCLAIMS ALL IMPLIED WARRANTIES OF MERCHANTABILITY AND FITNESS FOR A PARTICULAR PURPOSE, IN CONNECTION WITH ACCESSORIES, EQUIPMENT, MATERIALS OR COMPONENTS SOLD BUT NOT MANUFACTURED BY GRACO.** These items sold, but not manufactured by Graco (such as electric motors, switches, Hose, etc.), are subject to the warranty, if any, of their manufacturer. Graco will provide purchaser with reasonable assistance in making any claim for breach of these warranties.

In no event will Graco be liable for indirect, incidental, special or consequential damages resulting from Graco supplying equipment hereunder, or the furnishing, performance, or use of any products or other goods sold hereto, whether due to a breach of contract, breach of warranty, the negligence of Graco, or otherwise.

### **FOR GRACO CANADA CUSTOMERS**

The Parties acknowledge that they have required that the present document, as well as all documents, notices and legal proceedings entered into, given or instituted pursuant hereto or relating directly or indirectly hereto, be drawn up in English. Les parties reconnaissent avoir convenu que la rédaction du présente document sera en Anglais, ainsi que tous documents, avis et procédures judiciaires exécutés, donnés ou intentés, à la suite de ou en rapport, directement ou indirectement, avec les procédures concernées.

# Graco Information

For the latest information about Graco products, visit [www.graco.com](http://www.graco.com).

For patent information, see [www.graco.com/patents](http://www.graco.com/patents).

**TO PLACE AN ORDER**, contact your Graco distributor or call 1-800-690-2894 to identify the nearest distributor.



*All written and visual data contained in this document reflects the latest product information available at the time of publication.*

*Graco reserves the right to make changes at any time without notice.*

Original instructions. This manual contains English. MM 3A6342

**Graco Headquarters:** Minneapolis

**International Offices:** Belgium, China, Japan, Korea

**GRACO INC. AND SUBSIDIARIES • P.O. BOX 1441 • MINNEAPOLIS MN 55440-1441 • USA**

**Copyright 2018, Graco Inc. All Graco manufacturing locations are registered to ISO 9001.**

[www.graco.com](http://www.graco.com)

Revision F, August 2020