

FinishPro II 595 PC Pro Airless/Air-Assisted Sprayer

3A6564D

EN

For professional use only.

Not approved for use in explosive atmospheres or hazardous locations.

For portable application of architectural paints and coatings.

Models: 17E908, 17E915, 17E912, 17E913

3300 psi (228 bar, 22.8 MPa) Maximum Working Pressure

See page 3 for additional model information.



Important Safety Instructions

Read all warnings and instructions in this manual and in related manuals before using the equipment. Be familiar with the controls and the proper usage of the equipment. Save all instructions.

Related Manuals

Gun - 333182

Pump - 334599



t135370a





Use only genuine Graco replacement parts.

The use of non-Graco replacement parts may void warranty.

Contents

Models	3
Warnings	4
Component Identification	8
Grounding	9
Power Requirements	9
Extension Cords	9
Pails	9
Pressure Relief Procedure	10
Setup	12
Startup	15
Operation	17
Spray Tip Installation	17
Spray	18
Clear Spray Tip Clog	20
Cleanup	21
BlueLink™ App	24
Enabling or Disabling BlueLink	24
Maintenance	25
Recycling and Disposal at End of Life	25
Troubleshooting	26
Mechanical/Fluid Flow	26
Electrical	29
NOTES	38
Sprayer	39
Sprayers Parts List	41
Control Box	42
Control Box Parts List	43
Compressor	44
Compressor Parts List	45
Wiring Diagrams	46
120V	46
230V	47
Battery Replacement	48
Technical Specifications	49
Compliance	50
Radio Frequency Approvals	50
California Proposition 65	50
Graco Standard Warranty	51
Graco Information	52

Models

	VAC	Model	
 Intertek 110474 Certified to CAN/CSA C22.2 No. 68 Conforms to UL 1450	120 USA	FinishPro II 595PC Pro	17E908
	230 CEE 7/7	FinishPro II 595PC Pro	17E912
	230 Europe Multicord	FinishPro II 595PC Pro	17E913
	230 Asia/ANZ	FinishPro II 595PC Pro	17E915

Warnings

The following warnings are for the setup, use, grounding, maintenance, and repair of this equipment. The exclamation point symbol alerts you to a general warning and the hazard symbols refer to procedure-specific risks. When these symbols appear in the body of this manual or on warning labels, refer back to these Warnings. Product-specific hazard symbols and warnings not covered in this section may appear throughout the body of this manual where applicable.

WARNING



GROUNDING

This product must be grounded. In the event of an electrical short circuit, grounding reduces the risk of electric shock by providing an escape wire for the electric current. This product is equipped with a cord having a grounding wire with an appropriate grounding plug. The plug must be plugged into an outlet that is properly installed and grounded in accordance with all local codes and ordinances.

- Improper installation of the grounding plug is able to result in a risk of electric shock.
- When repair or replacement of the cord or plug is required, do not connect the grounding wire to either flat blade terminal.
- The wire with insulation having an outer surface that is green with or without yellow stripes is the grounding wire.
- Check with a qualified electrician or serviceman when the grounding instructions are not completely understood, or when in doubt as to whether the product is properly grounded.
- Do not modify the plug provided; if it does not fit the outlet, have the proper outlet installed by a qualified electrician.
- This product is for use on a nominal 120 V or 230 V circuit and has a grounding plug similar to the plugs illustrated in the figure below.

120V US



230V

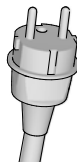

230V ANZ



ti24583a

- Only connect the product to an outlet having the same configuration as the plug.
- Do not use a 3-to-2 adapter with this product.
- Extension Cords:
 - Use only a 3-wire extension cord that has a grounding plug and a grounding receptacle that accepts the plug on the product.
 - Make sure your extension cord is not damaged. If an extension cord is necessary, use 12 AWG (2.5 mm²) minimum to carry the current that the product draws.
 - An undersized cord results in a drop in line voltage and loss of power and overheating.

WARNING
**FIRE AND EXPLOSION HAZARD**

Flammable fumes, such as solvent and paint fumes, in work area can ignite or explode. To help prevent fire and explosion:



- Do not spray flammable or combustible materials near an open flame or sources of ignition such as cigarettes, motors, and electrical equipment.



- Paint or solvent flowing through the equipment is able to result in static electricity. Static electricity creates a risk of fire or explosion in the presence of paint or solvent fumes. All parts of the spray system, including the pump, hose assembly, spray gun, and objects in and around the spray area shall be properly grounded to protect against static discharge and sparks. Use Graco conductive or grounded high-pressure airless paint sprayer hoses.



- Verify that all containers and collection systems are grounded to prevent static discharge. Do not use pail liners unless they are anti-static or conductive.
- Connect to a grounded outlet and use grounded extensions cords. Do not use a 3-to-2 adapter.
- Do not use a paint or a solvent containing halogenated hydrocarbons.
- Do not spray flammable or combustible liquids in a confined area.
- Keep spray area well-ventilated. Keep a good supply of fresh air moving through the area.
- Sprayer generates sparks. Keep pump assembly in a well-ventilated area at least 20 feet (6.1 m) from the spray area when spraying, flushing, cleaning, or servicing. Do not spray pump assembly.
- Do not smoke in the spray area or spray where sparks or flame is present.
- Do not operate light switches, engines, or similar spark producing products in the spray area.
- Keep area clean and free of paint or solvent containers, rags, and other flammable materials.
- Know the contents of the paints and solvents being sprayed. Read all Safety Data Sheets (SDSs) and container labels provided with the paints and solvents. Follow the paint and solvent manufacturer's safety instructions.
- Keep a working fire extinguisher in the work area.

WARNING

SKIN INJECTION HAZARD



High-pressure spray is able to inject toxins into the body and cause serious bodily injury. In the event that injection occurs, **get immediate surgical treatment.**



- Do not aim the gun at, or spray any person or animal.
- Keep hands and other body parts away from the discharge. For example, do not try to stop leaks with any part of the body.



- Always use the nozzle tip guard. Do not spray without nozzle tip guard in place.
- Use Graco nozzle tips.



- Use caution when cleaning and changing nozzle tips. In the case where the nozzle tip clogs while spraying, follow the **Pressure Relief Procedure** for turning off the unit and relieving the pressure before removing the nozzle tip to clean.



- Equipment maintains pressure after power is shut off. Do not leave the equipment energized or under pressure while unattended. Follow the **Pressure Relief Procedure** when the equipment is unattended or not in use, and before servicing, cleaning, or removing parts.

- Check hoses and parts for signs of damage. Replace any damaged hoses or parts.
- This system is capable of producing 3300 psi. Use Graco replacement parts or accessories that are rated a minimum of 3300 psi.
- Always engage the trigger lock when not spraying. Verify the trigger lock is functioning properly.
- Verify that all connections are secure before operating the unit.
- Know how to stop the unit and bleed pressure quickly. Be thoroughly familiar with the controls.

EQUIPMENT MISUSE HAZARD



Misuse can cause death or serious injury.



- Always wear appropriate gloves, eye protection, and a respirator or mask when painting.
- Do not operate or spray near children. Keep children away from equipment at all times.
- Do not overreach or stand on an unstable support. Keep effective footing and balance at all times.
- Stay alert and watch what you are doing.
- Do not operate the unit when fatigued or under the influence of drugs or alcohol.
- Do not kink or over-bend the hose.
- Do not expose the hose to temperatures or to pressures in excess of those specified by Graco.
- Do not use the hose as a strength member to pull or lift the equipment.
- Do not spray with a hose shorter than 25 feet.
- Do not alter or modify equipment. Alterations or modifications may void agency approvals and create safety hazards.
- Make sure all equipment is rated and approved for the environment in which you are using it.

WARNING



ELECTRIC SHOCK HAZARD

This equipment must be grounded. Improper grounding, setup, or usage of the system can cause electric shock.



- Turn off and disconnect power cord before servicing equipment.
- Connect only to grounded electrical outlets.
- Use only 3-wire extension cords.
- Ensure ground prongs are intact on power and extension cords.
- Do not expose to rain. Store indoors.
- Wait five minutes after disconnecting power cord before servicing.



PRESSURIZED ALUMINUM PARTS HAZARD

Use of fluids that are incompatible with aluminum in pressurized equipment can cause serious chemical reaction and equipment rupture. Failure to follow this warning can result in death, serious injury, or property damage.

- Do not use 1,1,1-trichloroethane, methylene chloride, other halogenated hydrocarbon solvents or fluids containing such solvents.
- Do not use chlorine bleach.
- Many other fluids may contain chemicals that can react with aluminum. Contact your material supplier for compatibility.



MOVING PARTS HAZARD

Moving parts can pinch, cut or amputate fingers and other body parts.



- Keep clear of moving parts.
- Do not operate equipment with protective guards or covers removed.
- Equipment can start without warning. Before checking, moving, or servicing equipment, follow the Pressure Relief Procedure and disconnect all power sources.



TOXIC FLUID OR FUMES HAZARD

Toxic fluids or fumes can cause serious injury or death if splashed in the eyes or on skin, inhaled, or swallowed.

- Read Safety Data Sheets (SDSs) to know the specific hazards of the fluids you are using.
- Store hazardous fluid in approved containers, and dispose of it according to applicable guidelines.



BURN HAZARD

Equipment surfaces and fluid that is heated can become very hot during operation. To avoid severe burns:

- Do not touch hot fluid or equipment.



PERSONAL PROTECTIVE EQUIPMENT

Wear appropriate protective equipment when in the work area to help prevent serious injury, including eye injury, hearing loss, inhalation of toxic fumes, and burns. This protective equipment includes but is not limited to:

- Protective eyewear, and hearing protection.
- Respirators, protective clothing, and gloves as recommended by the fluid and solvent manufacturer.

Component Identification

Component Identification

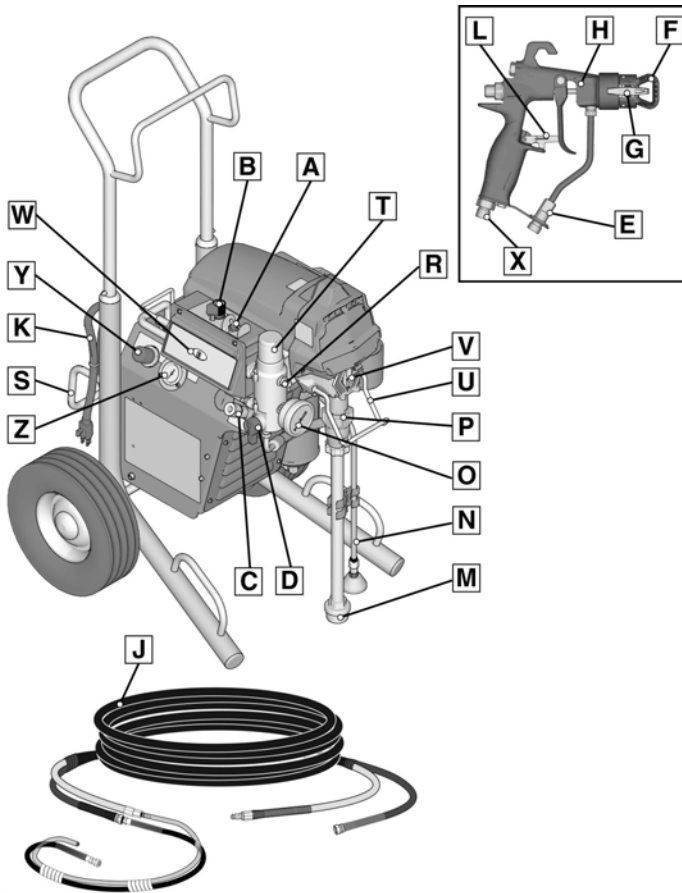

t125404a

A	Power/Function Selector
B	Pressure Control
C	Air Hose Connection
D	Prime Valve
E	Gun Filter
F	Tip Guard
G	Spray Tip
H	Gun
J	Airless Hose
K	Power Cord
L	Trigger Lock
M	Fluid Intake
N	Drain Tube

O	Pressure Gauge
P	Pump
R	Fluid Outlet
S	Hanger
T	Filter
U	Pail Hook
V	Finger Guard / TSL Fill Point
W	BlueLink™ Status Light or LCD Display
X	Gun Air Regulator
Y	Sprayer Air Pressure Regulator
Z	Air Pressure Gauge
	Model/Serial Tag (Not shown, located on bottom of unit.)

Grounding



The equipment must be grounded to reduce the risk of static sparking and electric shock. An electric or static spark can cause fumes to ignite or explode. An improper ground can cause electric shock. A good ground provides an escape wire for the electric current.

This sprayer is equipped with a power cord that has a ground wire and an appropriate grounding plug.

The plug must be plugged into an outlet that is properly installed and grounded in accordance with all local codes and ordinances.

Do not modify the plug provided; if it does not fit the outlet, have the proper outlet installed by a qualified electrician.

Power Requirements

- 100-120V units require 100-120 VAC, 50/60 Hz, 15A, 1 phase.
- 230V units require 230 VAC, 50/60 HZ, 10A, 1 phase.

Extension Cords

Use an extension cord with an undamaged ground contact. If an extension cord is necessary, use a 3-wire, 12 AWG (2.5 mm²) minimum.

NOTE: Smaller gauge or longer extension cords may reduce sprayer performance.

Pails

Solvent and oil-based fluids: follow local code. Use only conductive metal pails, placed on a grounded surface such as concrete.

Do not place pail on a non-conductive surface such as paper or cardboard which interrupts grounding continuity.



Always ground a metal pail: connect a ground wire to the pail. Clamp one end to the pail and the other end to a true earth ground such as a water pipe.

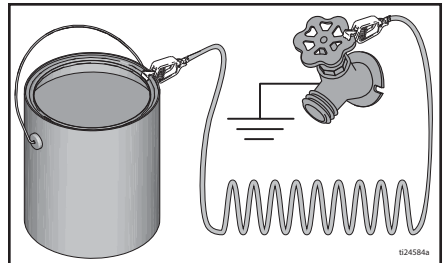

To maintain ground continuity when sprayer is flushed or pressure is relieved: hold metal part of spray gun firmly to the side of a grounded metal pail then trigger the gun.

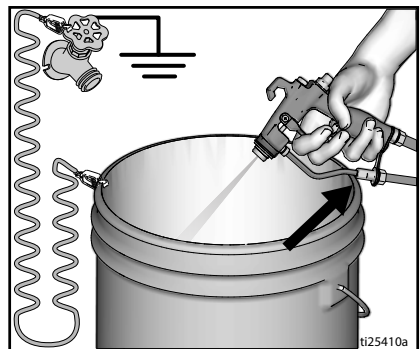

Pressure Relief Procedure

Pressure Relief Procedure



Follow the Pressure Relief Procedure whenever you see this symbol.

This equipment stays pressurized until pressure is manually relieved. To help prevent serious injury from pressurized fluid, such as skin injection, splashed fluid and moving parts, follow the **Pressure Relief Procedure** whenever sprayer is stopped and before sprayer is cleaned or checked, and before equipment is serviced.

1. Set SELECTOR switch to the **OFF** position.

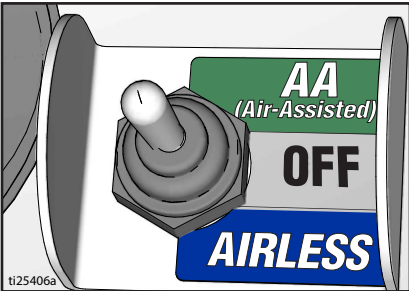

2. Engage the trigger lock.

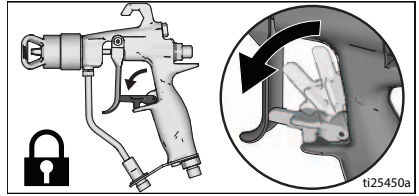

3. Turn pressure control to lowest setting. Disengage the trigger lock.



4. Hold a metal part of the gun firmly to a grounded metal pail. Trigger the gun to relieve pressure.

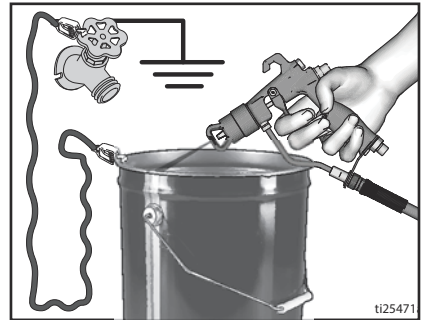

5. Engage the trigger lock.

Pressure Relief Procedure

- Put drain tube in a pail. Turn prime valve down. Leave prime valve in the down (drain) position until you are ready to spray again.

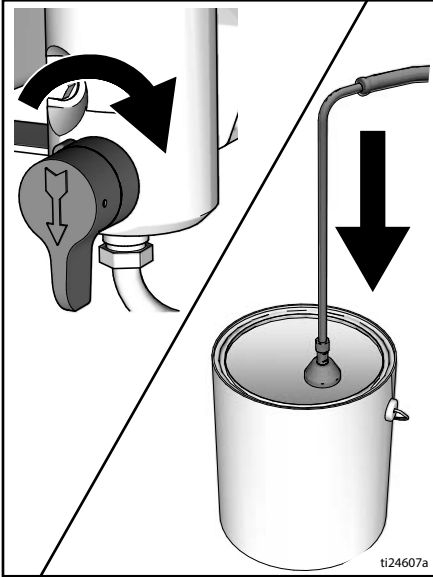

- If you suspect the spray tip or hose is clogged or that pressure has not been fully relieved:

- VERY SLOWLY loosen the tip guard retaining nut or the hose end coupling to relieve pressure gradually.
- Loosen the nut or coupling completely.
- Clear hose or tip obstruction.

Trigger Lock

Always engage the trigger lock when sprayer is stopped to prevent the gun from being triggered accidentally by hand or if dropped or bumped.

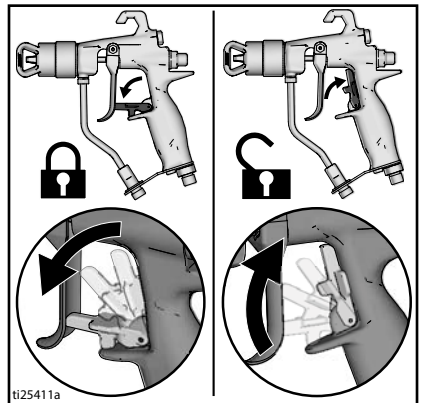

Setup

Setup

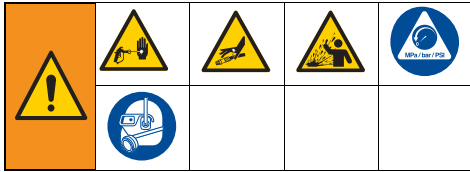

When unpacking sprayer for the first time or after long term storage perform setup procedure. When first setup is performed remove shipping plug from fluid outlet.

1. Connect Graco airless hose to fluid outlet. Use wrenches to tighten securely.

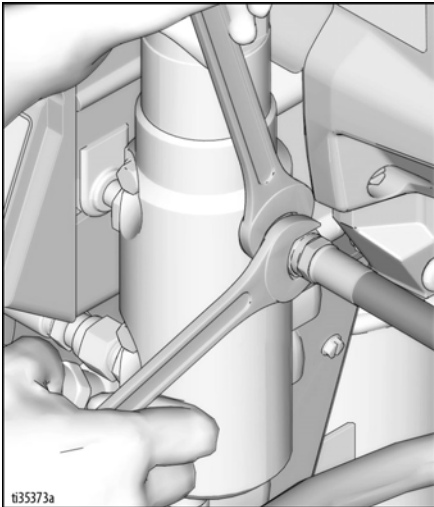

2. Connect other end of hose to gun.

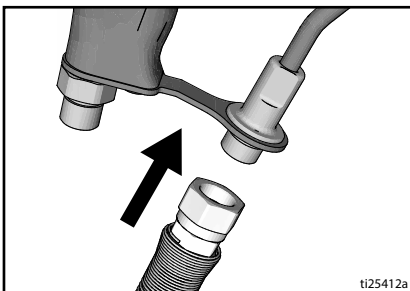

3. Use wrenches to tighten securely.
4. Engage trigger lock.

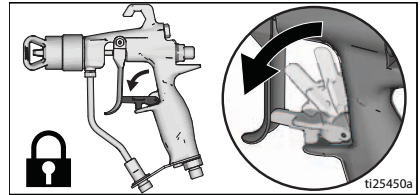

5. Remove tip guard/air cap.

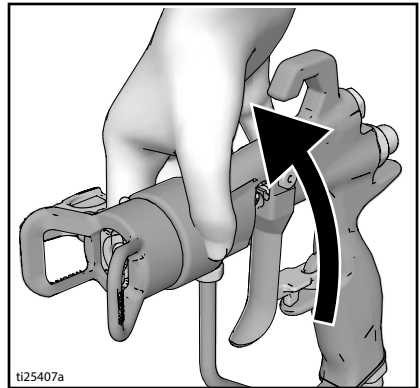

6. When unpacking sprayer for the first time remove packaging materials from inlet strainer. After long term storage check inlet strainer for clogs and debris.

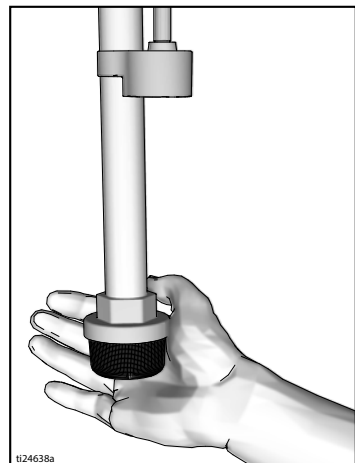

7. Fill throat packing nut with TSL™ to prevent premature packing wear. Do this daily or each time you spray.
 - a. Place the TSL bottle nozzle into the top center opening in the grill at the front of the sprayer.
 - b. Squeeze bottle to dispense enough TSL to fill the space between the pump rod and packing nut seal.

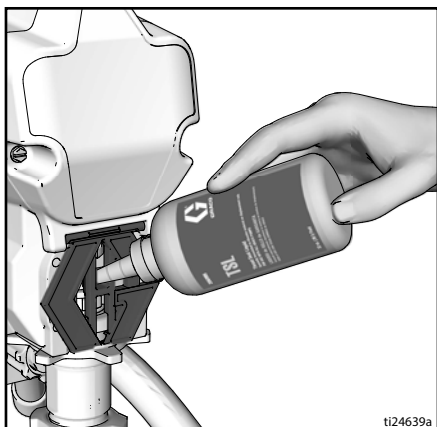

ti24639a

8. Make certain SELECTOR switch is **OFF**.



ti25406a

9. Plug power supply cord into a properly grounded electrical outlet.

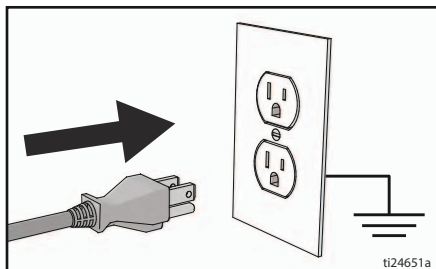

ti24651a

10. Turn prime valve down.

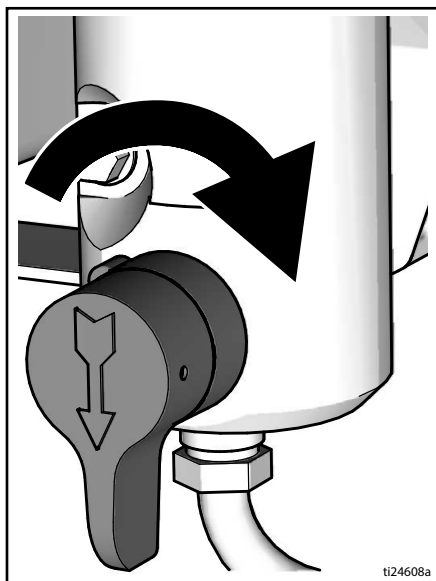

ti24608a

11. Place fluid intake with drain tube in grounded metal pail partially filled with flushing fluid. See **Grounding**, page 9.

NOTE: New sprayers are shipped with storage fluid that must be flushed out with mineral spirits prior to using the sprayer.

Check flushing fluid for compatibility with material that is to be sprayed. A secondary flush with a compatible fluid may be necessary. Use water for latex paint or mineral spirits for oil-based paint.

Setup

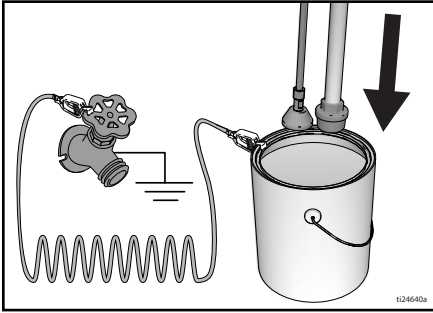

12. Turn pressure control to OFF.
13. Set SELECTOR switch to **ON** position.
14. Turn prime valve horizontal. Disengage trigger lock.
15. Turn pressure control to Prime/Slow.
16. Hold a metal part of the gun firmly to a grounded metal pail. Trigger gun and flush for one minute.
17. Set SELECTOR switch to **OFF** position.
18. Engage trigger lock.
19. After flushing storage fluid out of the sprayer empty pail. Replace fluid intake with drain tube in grounded metal pail partially filled with flushing fluid. Use water to flush water-based paint or mineral spirits to flush oil-based paint.
20. Set SELECTOR switch to **ON** position.
21. Turn prime valve horizontal. Disengage trigger lock.

22. Hold a metal part of the gun firmly to a grounded metal pail. Trigger gun and flush until clean.
23. Set SELECTOR switch to **OFF** position.
24. Engage trigger lock.
25. Sprayer is now ready to startup and spray in airless mode.
26. Attach air hose to sprayer air hose connection.

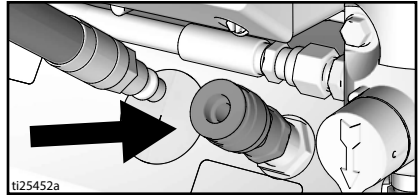

27. Cut air hose to length and couple to air connection on gun.

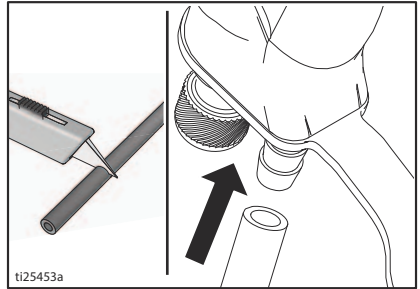

28. Sprayer is now ready to startup and spray in air-assisted (AA) mode.

Startup

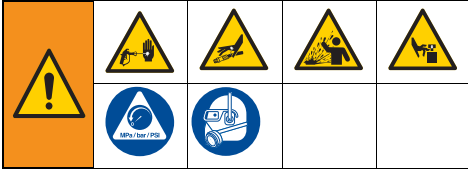

1. Perform **Pressure Relief Procedure**, page 10.
2. Turn pressure control to lowest pressure.



3. Set **SELECTOR** switch to **AIRLESS** position.



4. Place fluid intake in paint pail. Place drain tube in waste pail.
5. Turn pressure control to **Fast Flush** to start motor. Allow paint to circulate through drain tube for 15 seconds.



6. Turn prime valve horizontal. Disengage trigger lock.

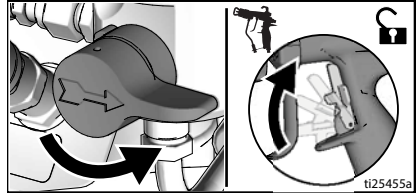

7. Hold gun against grounded metal waste pail. Trigger gun until paint appears.

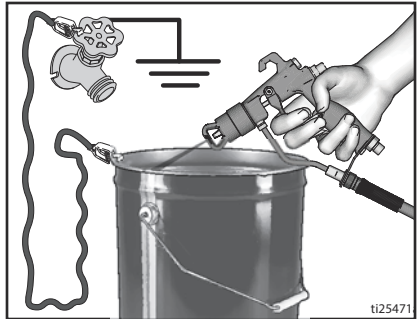

8. Move gun to paint pail and trigger for 20 seconds. Release trigger and allow sprayer to build pressure. Engage trigger lock.

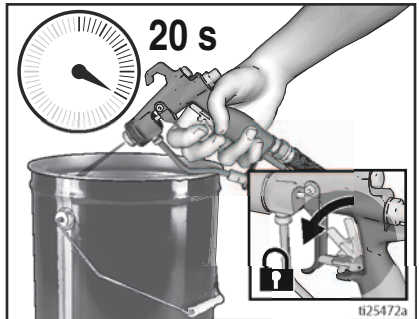

Startup



High-pressure spray is able to inject toxins into the body and cause serious bodily injury. Do not stop leaks with hand or rag.

9. Inspect for leaks. If leaks occur, perform **Pressure Relief Procedure**, page 10, then tighten all fittings and repeat Startup procedure. If there are no leaks continue with the next step.

10. Screw tip assembly onto gun and tighten. See **Spray Tip Installation**, page 17. For gun assembly instructions, see separate gun manual.

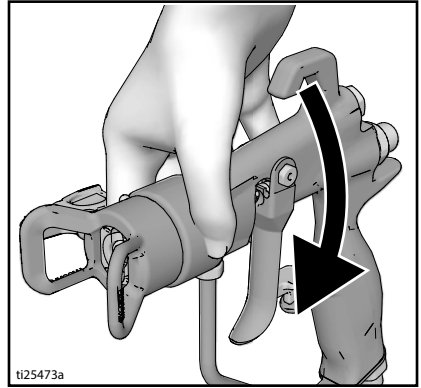

Operation

Spray Tip Installation



To avoid serious injury from skin injection do not put your hand in front of the spray tip when installing or removing the spray tip and tip guard.

1. Perform **Pressure Relief Procedure**, page 10.
2. Engage trigger lock.

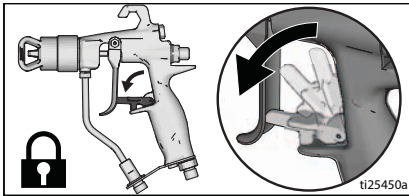

3. Insert seat (33a) into seat housing (35).
4. Insert seat housing (35) into air cap (6).
5. Insert seal (33b) over seat (33a). Use black seal for water-based materials and orange seal for solvent and oil-based materials.

6. Insert tip into slot (a) in air cap (6).

NOTICE

If air cap is not fully installed on gun, fluid pressure can force paint into air line and damage sprayer.

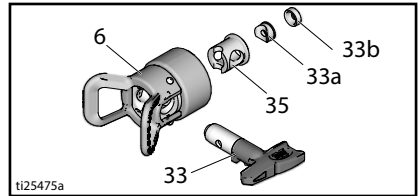

7. Install air cap (6) over end of gun. Hand tighten.

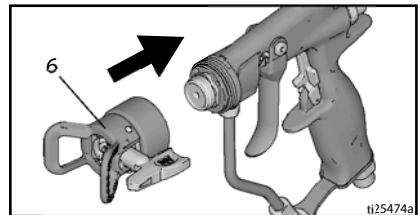

Tip Selection

Material	Oil Based	Water Based	Tip Size	Fluid Setting	Air setting
Stains/Varnish	✓	✓	.008/.010	500-700 psi (34-48 bar)	10-15 psi (0.7-1.0 bar)
Lacquers	✓	✓	.008/.010	700-1000 psi (48-69 bar)	10-15 psi (0.7-1.0 bar)
DTM		✓	.010/.012	900-1200 psi (62-83 bar)	15-20 psi (1.0-1.4 bar)
DTM (Alkyd)	✓		0.14/0.16	1800-2400 psi (124-165 bar)	20-25 psi (1.4-1.7 bar)
Enamels	✓	✓	0.14/0.16	1800-2400 psi (124-165 bar)	25-30 psi (1.7-2.1 bar)

Operation

Spray

When a RAC X™ FF LP Fine Finish Low Pressure reversible spray tip is used, spraying pressure can be lowered. Spraying at a lower pressure results in less overspray and reduces spray tip wear. Adjust the sprayer pressure to minimize overspray.

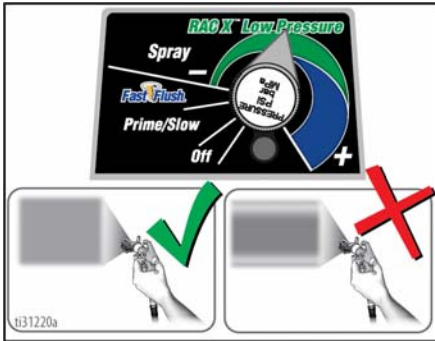

Atomized, evenly distributed fan pattern

Tails

Air-Assisted Spraying

NOTE: In high humidity conditions, moisture can accumulate in the air line. If this occurs, install an in-line desiccant filter (24U981 or 24U982) to prevent moisture from entering the gun.

1. Set SELECTOR switch to **AIRLESS** position.



2. Open gun air regulator all the way.

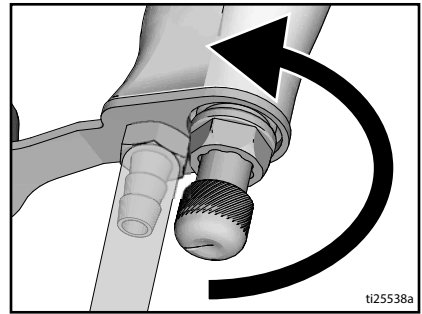

3. Prime pump, see **Startup**, page 15.
4. Set fluid pressure to highest setting.

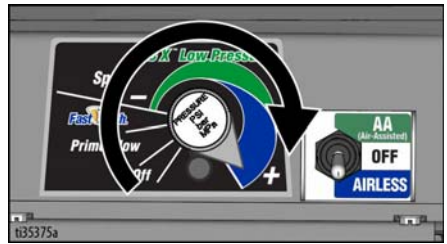

5. While spraying gun, decrease fluid pressure until tails appear in spray pattern.
6. Set SELECTOR switch to **AA** (Air-Assisted).



7. Trigger gun. While spraying, turn air regulator knob to increase pressure until tails disappear.

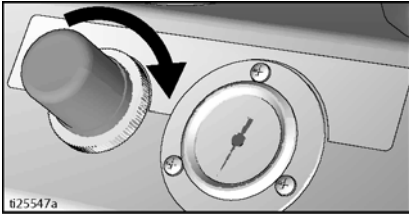

8. Use gun air regulator to fine tune spray pattern.

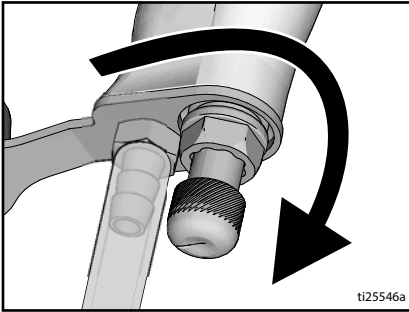

Airless Spraying

1. Set SELECTOR switch to **AIRLESS** position.



2. Prime pump, see **Startup**, page 15.
3. Start with pressure turned to the lowest setting. Spray test pattern. Gradually increase fluid pressure until you achieve a consistent spray pattern without heavy edges. Use a smaller tip size if pressure adjustment alone does not eliminate heavy edges.

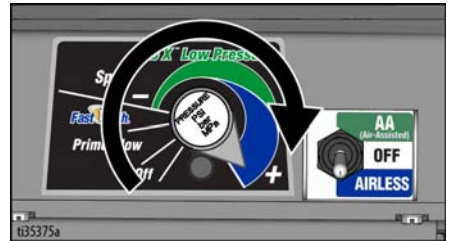

- Hold gun perpendicular and 10-12 inches from the surface. Overlap strokes by 50%.
- Move gun before triggering and release trigger before stopping.

Operation

Clear Spray Tip Clog



1. Engage trigger lock.

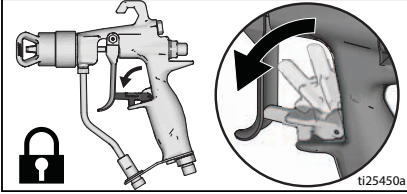

2. For a **Flat tip**, perform **Pressure Relief Procedure**, page 10, remove and clean guard and tip. For a **RAC tip**, proceed to the next step.
3. Rotate tip 180° to **UNCLOG** position.

NOTE: If Spray Tip is difficult to rotate when turning to the **UNCLOG** position, perform **Pressure Relief Procedure**, page 10, then turn Prime/Spray Valve horizontal to **SPRAY** position and repeat procedure starting at step 1.

4. Disengage trigger lock.
5. Trigger gun at waste area to clear clog.
6. Engage trigger lock.
7. Rotate tip back 180° to **SPRAY** position.
8. Disengage Trigger Lock and continue spraying.

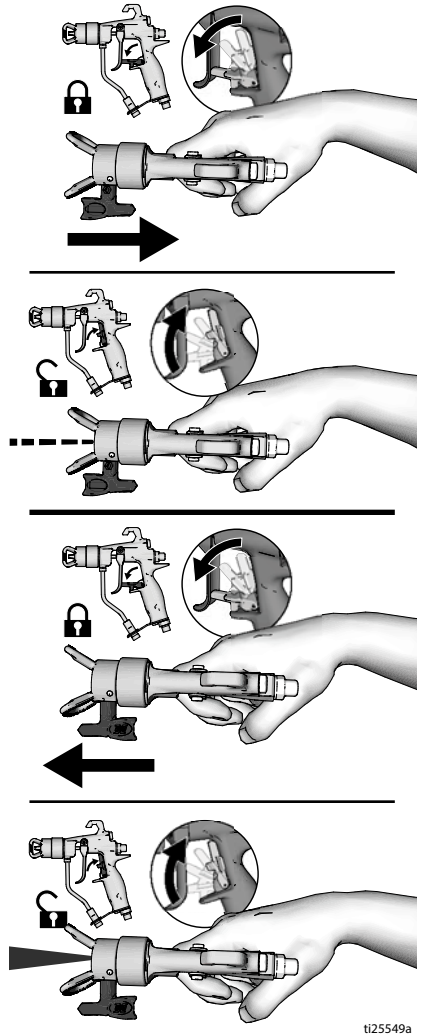

Cleanup

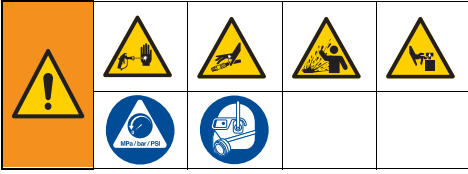

1. Perform **Pressure Relief Procedure**, page 10.
2. Remove tip guard and spray tip. For additional information, see separate gun manual.

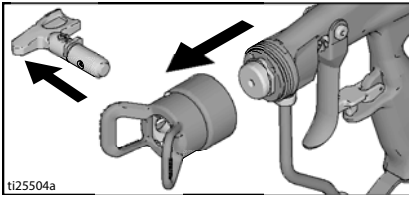

Fast Flush Drain Tube

3. Remove fluid intake and drain tube from paint, wipe excess paint off outside.

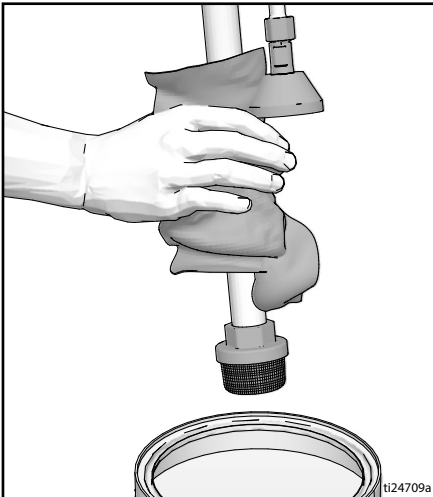

4. Place fluid intake in flushing fluid. Use water for water base paint and mineral spirits for oil-based paint. Place drain tube in waste pail.

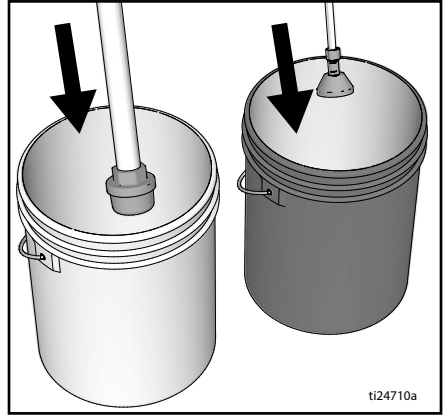

5. To flush drain tube and pump turn prime valve down.



6. Turn pressure control to Fast Flush. Hold gun against grounded waste pail. Operate until the pump runs steady and flushing fluid appears in the waste pail.

Operation

Fast Flush Hose and Gun

7. To flush airless hose and spray gun, turn prime valve horizontal.
8. Hold gun against grounded waste pail. Disengage trigger lock. Turn pressure control to Fast Flush, trigger gun until the pump runs steady and flushing fluid appears.



9. Stop triggering gun.
10. Raise fluid intake above flushing fluid.

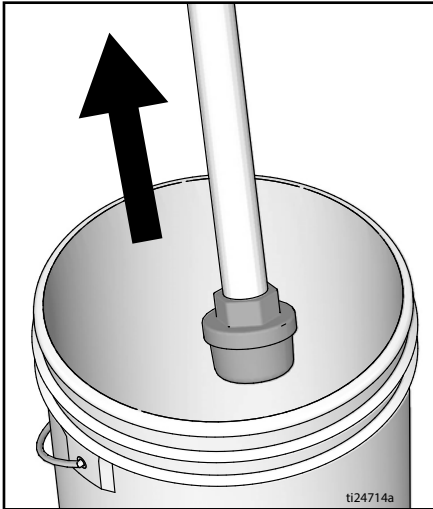

11. With prime valve horizontal. Trigger gun into flushing pail to purge fluid from hose.

12. Set SELECTOR switch to **AA** Air-Assisted position.



13. Trigger gun and slowly increase air pressure to blow material out of the gun air passages.
14. Engage trigger lock.

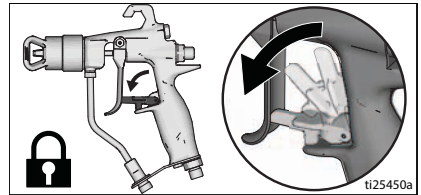

15. Turn pressure control knob to **OFF** and set **SELECTOR** switch to **OFF** position. Disconnect power to sprayer.



16. Remove filter from gun and sprayer if installed. Clean and inspect. Install filter. See separate gun manual.

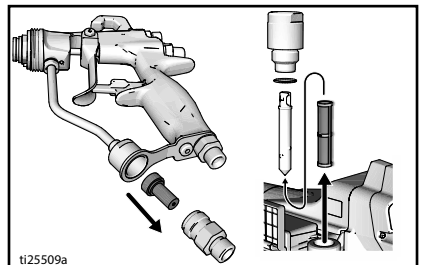

17. If flushing with water, flush again with mineral spirits or Pump Armor to leave a protective coating to prevent freezing or corrosion.

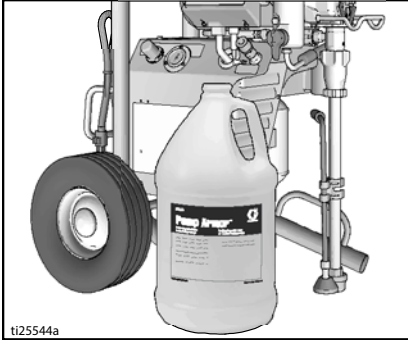

18. Wipe sprayer, hose and gun with a rag soaked in water or mineral spirits.

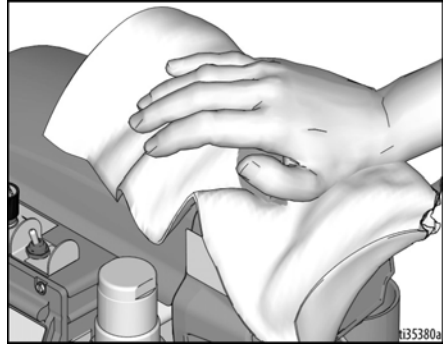

BlueLink™ App

Download the Graco BlueLink app from the Apple App Store or Google Play to connect to the paint sprayer via Bluetooth®.

The BlueLink app allows you to access sprayer information, settings, statistics, and provides access to useful features such as WatchDog™, improved maintenance tracking, sprayer tracking, and job tracking. Find the Graco BlueLink App at:

<https://www.graco.com/BlueLink>



Further instructions can be accessed within the app. Instructions can also be accessed online at:

<https://www.graco.com/BlueLinkSupport>



Enabling or Disabling BlueLink



The Graco BlueLink system uses Bluetooth to communicate between the sprayer's control board and a mobile phone. To disable BlueLink by shutting off the Bluetooth transmitter, perform the following steps:

1. Turn the ON/OFF switch to the **OFF** position. Turn the Pressure Control Knob all the way counterclockwise to the **OFF** position.
2. Unplug sprayer from power outlet and allow power to dissipate for 5 minutes.
3. Remove control box cover.
4. On the main control board, disconnect the ribbon cable. To enable BlueLink, re-connect this cable.



5. Reassemble control box cover.

Maintenance

Routine maintenance is important to ensure proper operation of your sprayer. Maintenance includes performing routine actions which keep your sprayer in operation and prevents trouble in the future.



Activity	Interval
Inspect/clean sprayer filter, fluid inlet strainer, and gun filter.	Daily or each time you spray
Inspect motor shield vents for blockage.	Daily or each time you spray
Fill TSL by adding through TSL fill point.	Daily or each time you spray
Check sprayer stall. With sprayer gun NOT triggered, sprayer motor should stall and not restart until gun is triggered again. If sprayer starts again with gun NOT triggered, inspect pump for internal/external leaks and check prime valve for leaks.	Every 1000 gallons (3785 liters)
Throat packing adjustment When pump packing begins to leak after extended use, tighten packing nut down until leakage stops or lessens. This allows approximately 100 gallons of additional operation before a repacking is required. Packing nut can be tightened without O-ring removal.	As necessary based on usage



Maintenance can be scheduled and tracked via the Graco BlueLink app.

Recycling and Disposal at End of Life

At the end of the product's useful life, dismantle and recycle it in a responsible manner.

Preparation:

- Perform the **Pressure Relief Procedure**, page 10.
- Drain and dispose of fluids according to applicable regulations. Refer to the material manufacturer's Safety Data Sheet.

Dismantle and recycle:

- Remove motors, circuit boards, displays, and other electronic components. Remove the coin-cell battery from the battery holder on the control board. Recycle according to applicable regulations.
- Do not dispose of electronic components with household or commercial waste.
- Deliver remaining product to a recycling facility.

Troubleshooting

Mechanical/Fluid Flow



1. Follow **Pressure Relief Procedure**, page 10, before checking or repairing.
2. Check all possible problems and causes before disassembling the unit.

Problem	What to Check If check is OK, go to next check	What to Do When check is not OK, refer to this column
Control board status light is blinking or the light is off and there is power to the sprayer.	Fault condition exists.	Determine fault correction from Electrical , page 29.
Pump output is low	Spray tip worn.	Follow Pressure Relief Procedure , page 10, then replace tip. See separate gun or tip manual.
	Spray tip clogged.	Relieve pressure. Check and clean spray tip.
	Paint supply.	Refill and reprime pump.
	Intake strainer clogged.	Remove and clean, then reinstall.
	Intake valve ball and piston ball are not seating properly.	Remove intake valve and clean. Check balls and seats for nicks; replace if necessary. See pump manual. Strain paint before using to remove particles that could clog pump.
	Fluid filter or tip filter is clogged or dirty.	Clean filter.
	Prime valve leaking.	Follow Pressure Relief Procedure , page 10, then repair prime valve.
	Verify pump does not continue to stroke when gun trigger is released. (Prime valve not leaking.)	Service pump. See pump manual.
Leaking around throat packing nut which may indicate worn or damaged packings.	Replace packings. See pump manual. Also check piston valve seat for hardened paint or nicks and replace if necessary. Tighten packing nut/wet-cup.	

Problem	What to Check If check is OK, go to next check	What to Do When check is not OK, refer to this column
Pump output is low	Pump rod damage.	Repair pump. See pump manual.
	Low stall pressure.	Turn pressure knob fully clockwise. Make sure pressure control knob is properly installed to allow full clockwise position. If problem persists, replace pressure transducer.
	Piston packings are worn or damaged.	Replace packings. See pump manual.
	O-ring in pump is worn or damaged.	Replace o-ring. See pump manual.
	Intake valve ball is packed with material.	Clean intake valve. See pump manual.
	Large pressure drop in hose with heavy materials.	Reduce overall length of hose.
	Check extension cord for correct size.	See Extension Cords , page 9.
Motor runs but pump does not stroke	Connecting rod assembly damaged. See pump manual.	Replace connecting rod assembly. See pump manual.
	Gears or drive housing damaged.	Inspect drive housing assembly and gears for damage and replace if necessary.
Excessive paint leakage into throat packing nut	Throat packing nut is loose.	Remove throat packing nut spacer. Tighten throat packing nut just enough to stop leakage.
	Throat packings are worn or damaged.	Replace packings. See pump manual.
	Displacement rod is worn or damaged.	Replace rod. See pump manual.
Fluid is spitting from gun	Air in pump or hose.	Check and tighten all fluid connections. Cycle pump as slowly as possible during priming.
	Spray tip is partially clogged.	Clear tip. See Clear Spray Tip Clog , page 20.
	Fluid supply is low or empty.	Refill fluid supply. Prime pump. See pump manual. Check fluid supply often to prevent running pump dry.

Troubleshooting

Problem	What to Check If check is OK, go to next check	What to Do When check is not OK, refer to this column
Pump is difficult to prime	Air in pump or hose.	Check and tighten all fluid connections. Cycle pump as slowly as possible during priming.
	Intake valve is leaking.	Clean intake valve. Be sure ball seat is not nicked or worn and that ball seats well. Reassemble valve.
	Pump packings are worn.	Replace pump packings. See pump manual.
	Paint is too thick.	Thin the paint according to supplier recommendations.
Sprayer operates for 5 to 10 minutes then stops	Pump packing nut too tight. When pump packing nut is too tight the packings on the pump rod restrict pump action and overloads the motor.	Loosen pump packing nut. Check for leaks around throat. If necessary, replace pump packings. See Pump manual.

Electrical

Symptom: Sprayer does not run, stops running, or will not shut off.



1. Perform **Pressure Relief Procedure**, page 10.
2. Plug sprayer into correct voltage, grounded outlet.
3. Set the SELECTOR switch **OFF** wait 30 seconds and then turn power back **ON** again (this ensures sprayer is in normal run mode).
4. Turn pressure control knob clockwise 1/2 turn.

5. Remove control box cover to view control board status light. To determine which code (or any other code besides voltage supply) refer to the control board status light. Set the SELECTOR switch **OFF**, remove the control cover then turn power back **ON**. Observe the status light. Blinking LED total count equals the error code (for example: two blinks equals CODE 02).



Keep clear of electrical and moving parts during troubleshooting procedures. To avoid electrical shock hazards when covers are removed for troubleshooting, wait 7 seconds after disconnecting power cord for stored electricity to dissipate.

Error Code Messages



CODE	MESSAGE	ACTION
02	HIGH PRESSURE DETECTED - RELIEVE PRESSURE	Check for clogs. Use only Graco spray hoses, use a minimum of 50ft/15m.
03	PRESSURE TRANSDUCER NOT DETECTED	Check transducer connection.
05	MOTOR NOT SPINNING	Check for mechanical failure and check motor connections. Material may be too thick, thin material.
06	MOTOR OVERHEATED	Turn sprayer OFF. Check motor connections. Check shroud vents for blockage. Sprayer may take up to an hour to cool.

Troubleshooting

Problem	What to Check	How to check
Sprayer does not run at all AND Control board status light never lights	See flow chart, page 35.	
Sprayer does not shut off AND Control board status light blinks 2 times repeatedly	Control board.	Replace control board.
Sprayer does not run at all AND Control board status light blinks 2 times repeatedly	Check transducer or transducer connections	<p>Make sure there is no pressure in the system (see Pressure Relief Procedure, page 10). Check fluid path for clogs, such as clogged filter.</p> <p>Use airless paint spray hose with no metal braid. A small hose or metal braid hose may result in high-pressure spikes.</p> <p>Set SELECTOR switch OFF and disconnect power to sprayer.</p> <p>Check transducer and connections to control board.</p> <p>Disconnect transducer from control board socket. Check that transducer and control board contacts are clean and secure.</p> <p>Reconnect transducer to control board socket. Connect power, set SELECTOR switch ON and control knob 1/2 turn clockwise. If sprayer does not run properly, set SELECTOR switch OFF and go to next step.</p> <p>Install new transducer. Connect power, set SELECTOR switch ON and control knob 1/2 turn clockwise. Replace control board if sprayer does not run properly.</p>

Problem	What to Check	How to check
<p>Sprayer does not run at all AND Control board status light blinks 3 times repeatedly</p>	<p>Check transducer or transducer connections (control board is not detecting a pressure signal).</p>	<p>Set SELECTOR switch OFF and disconnect power to sprayer.</p> <p>Check transducer and connections to control board.</p> <p>Disconnect transducer from control board socket. Check to see if transducer and control board contacts are clean and secure.</p> <p>Reconnect transducer to control board socket. Connect power, set SELECTOR switch ON and control knob to 1/2 turn clockwise. If sprayer does not run, set SELECTOR switch OFF and go to next step.</p> <p>Connect a confirmed working transducer to control board socket.</p> <p>Set SELECTOR switch ON and control knob to 1/2 turn clockwise. If sprayer runs, install new transducer. Replace control board if sprayer does not run.</p> <p>Check transducer resistance with an ohmmeter (less than 9k ohm between red and black wires and 3-6k ohm between green and yellow wires).</p>
<p>Sprayer does not run at all AND Control board status light blinks 5 times repeatedly</p>	<p>Control is commanding motor to run but motor shaft does not rotate. Possibly locked rotor condition, an open connection exists between motor and control, there is a problem with motor or control board, or motor amp draw is excessive.</p>	<ol style="list-style-type: none"> 1. Remove pump and try to run sprayer. If motor runs, check for locked or frozen pump or drive train. If sprayer does not run, continue to step 2. 2. Set SELECTOR switch OFF and disconnect power to sprayer. 3. Disconnect motor connector(s) from control board socket(s). Check that motor connector and control board contacts are clean and secure. If contacts are clean and secure, continue to step 4. 4. Set sprayer to OFF and spin motor fan 1/2 turn. Restart sprayer. If sprayer runs replace control board. If sprayer does not run, continue to step 5.

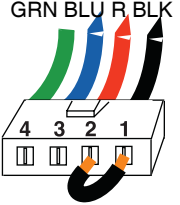
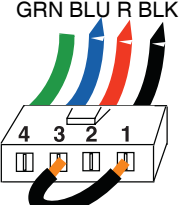
Troubleshooting

Problem	What to Check	How to check
		<p>5. Perform Spin Test: Test at large 4-pin motor field connector. Disconnect fluid pump from sprayer. Test motor by placing a jumper across pins 1 & 2. Rotate motor fan at about 2 revolutions per second. A cogging resistance to motion should be felt at the fan. The motor should be replaced if no resistance is felt. Repeat for pin combinations 1 & 3 and 2 & 3. Pin 4 (the green wire) is not used in this test. If all spin test is positive, continue to step 6.</p> <p>STEP 1:</p>  <p>STEP 2:</p>  <p>STEP 3:</p> 

Problem	What to Check	How to check
		<p>6. Perform Field Short Test: Test at large 4-pin motor field connector. There should not be continuity from pin 4, the ground wire, and any of the remaining 3 pins. If motor field connector tests fail, replace motor.</p> <p>7. Reconnect motor connector(s) to control board socket(s). Connect power, set SELECTOR switch ON and control knob to 1/2 turn clockwise. If motor does not run, replace control board.</p>
<p>Sprayer does not run at all AND Control board status light blinks 6 times repeatedly</p>	<p>Motor is hot or there is a fault in the motor thermal device.</p>	<p>Allow sprayer to cool. If sprayer runs when cool, correct cause of overheating. Keep sprayer in cooler location with good ventilation. Make sure motor air intake is not blocked. If sprayer still does not run, replace motor.</p> <p>NOTE: Motor must be cooled down for the test.</p> <ol style="list-style-type: none"> 1. Check thermal device connector (yellow wires) at control board. 2. Disconnect thermal device connector from control board socket. Make sure contacts are clean and secure. Measure resistance of the thermal device. If reading is not correct, replace motor. <p>Check Motor Thermal Switch: Unplug thermal wires. Set meter to ohms. Meter should read 100k ohms.</p> <ol style="list-style-type: none"> 3. Reconnect thermal device connector to control board socket. Connect power, turn sprayer ON and control knob 1/2 turn clockwise. If sprayer does not run, replace control board.

Troubleshooting

Problem	What to Check	How to check
Basic electrical problems	Motor leads are securely fastened and properly mated	Replace loose terminals; crimp to leads. Be sure terminal are firmly connected. Clean circuit board terminals. Securely reconnect leads.
	Motor armature commutator for burn spots, gouges or extreme roughness.	Remove motor and have motor shop resurface commutator if possible.

Electrical cont...

Sprayer Will Not Run

(See following page for steps)

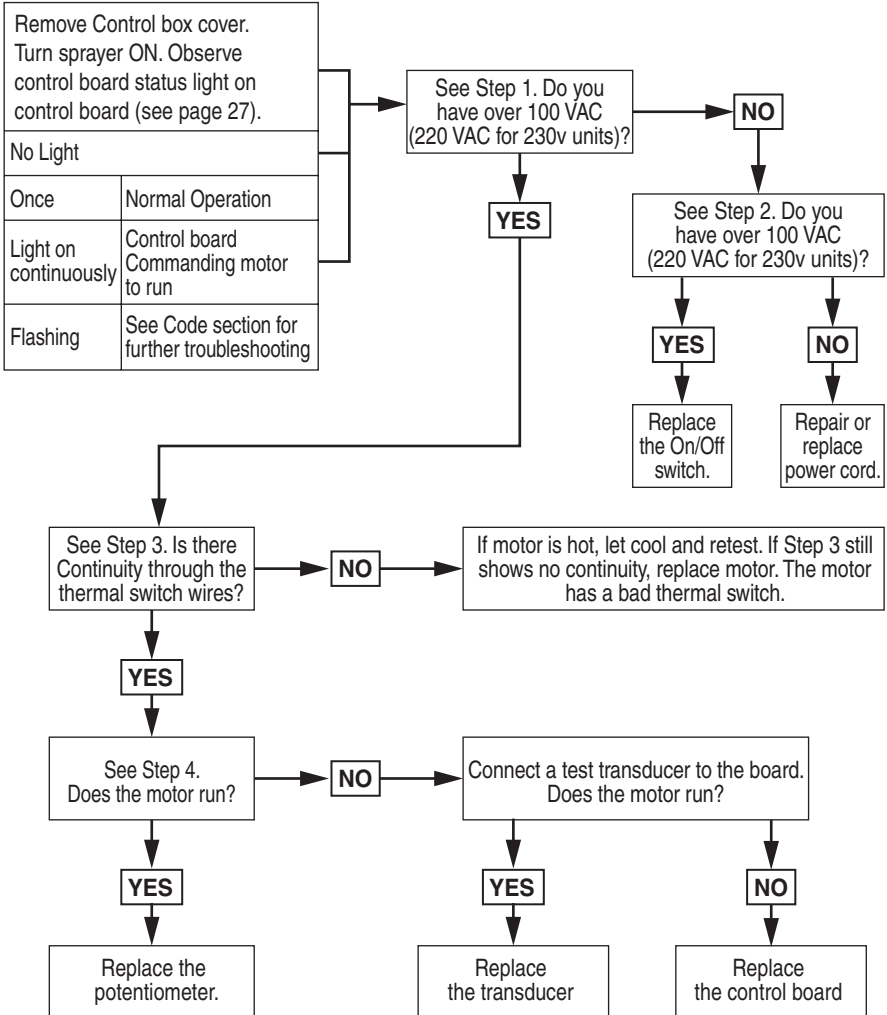

t124726a

Troubleshooting

Electrical

Step 1:

Plug Power cord in and turn switch ON. Connect probes to ontrol board. Turn meter to AC Volts.

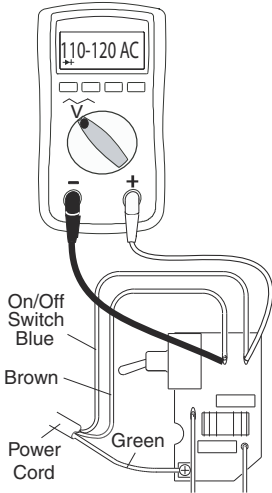

Step 2:

Plug Power cord in and turn switch ON. Connect probes to control board. Turn meter to AC Volts

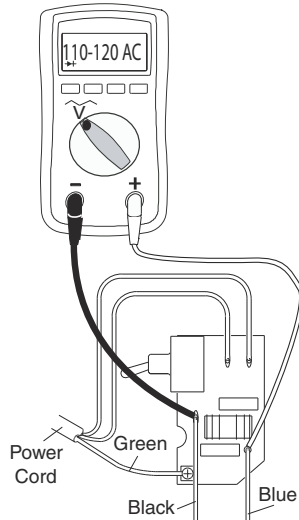

Step 3:

Check motor thermal switch. Unplug yellow wires. Meter should read 100 ohms. NOTE: Motor should be cool during reading.

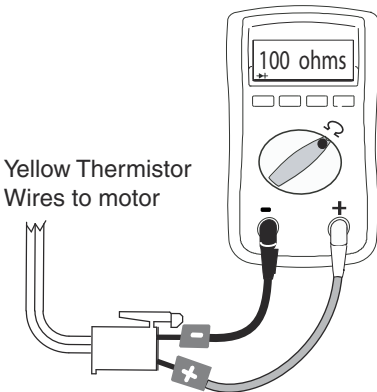

Step 4:

Disconnect potentiometer. Plug power cord in and turn switch ON.

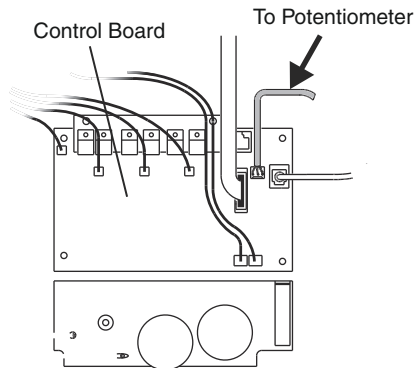

ti24084a

Electrical cont...

Sprayer Will Not Shut Off

1. Perform **Pressure Relief Procedure**, page 10. Leave prime valve open (down) and set SELECTOR switch **OFF**.

2. Remove control box cover so the control board status light can be viewed if available.

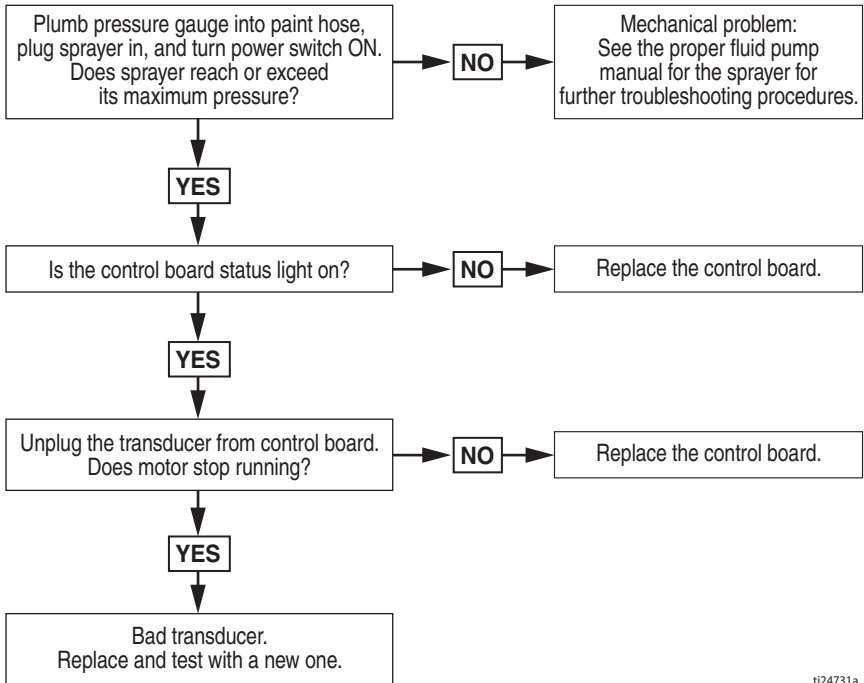

Troubleshooting Procedure



ti24731a

Sprayer

See page 44 for Compressor parts.

Ref.	Torque
	140-160 in-lb (15.8 - 18.1 N•m)
	30-35 in-lb (3.4 - 4.0 N•m)

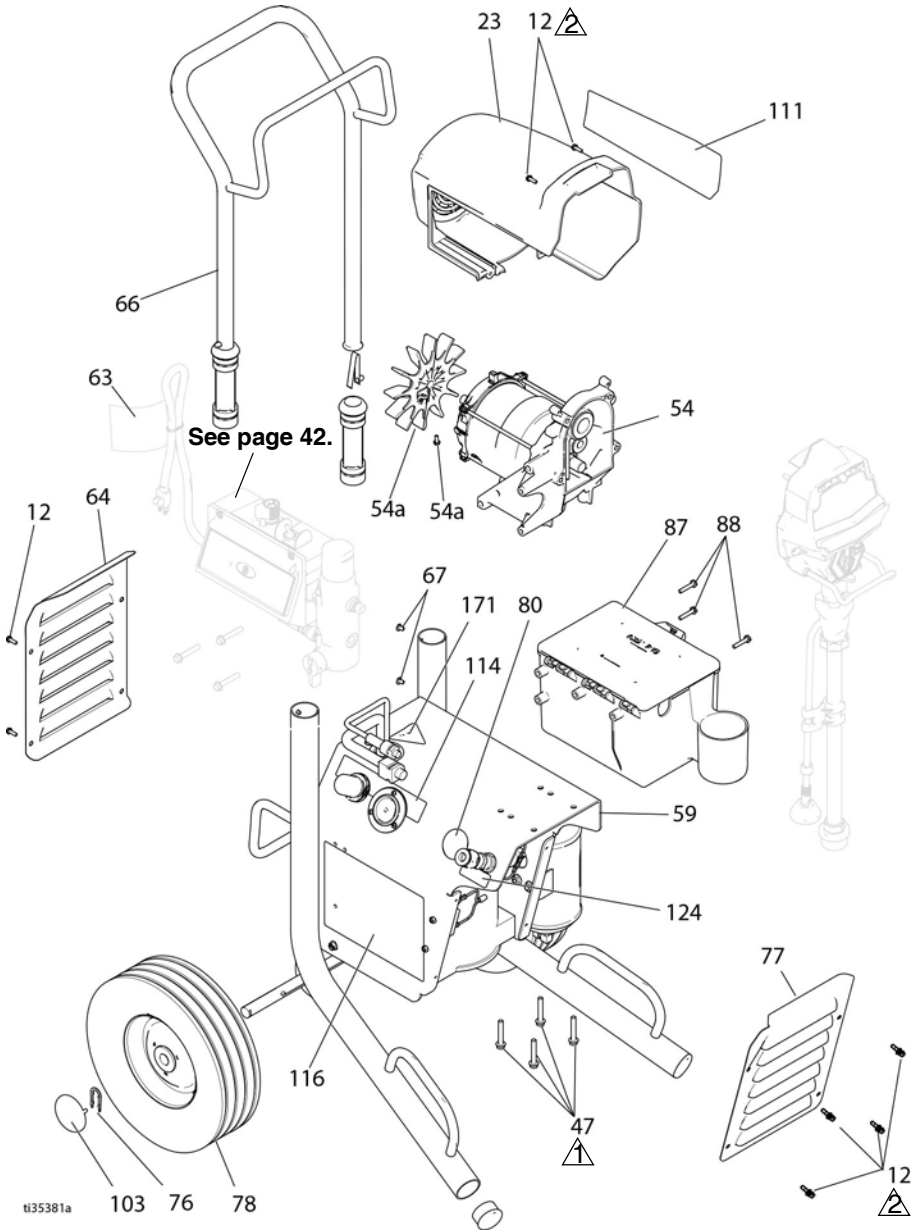

Sprayer

Ref.	Torque
①	140-160 in-lb (15.8 - 18.1 N•m)
②	30-35 in-lb (3.4 - 4.0 N•m)
③	Hammer tight
④	25-30 ft-lb (33.9 - 40.7 N•m)

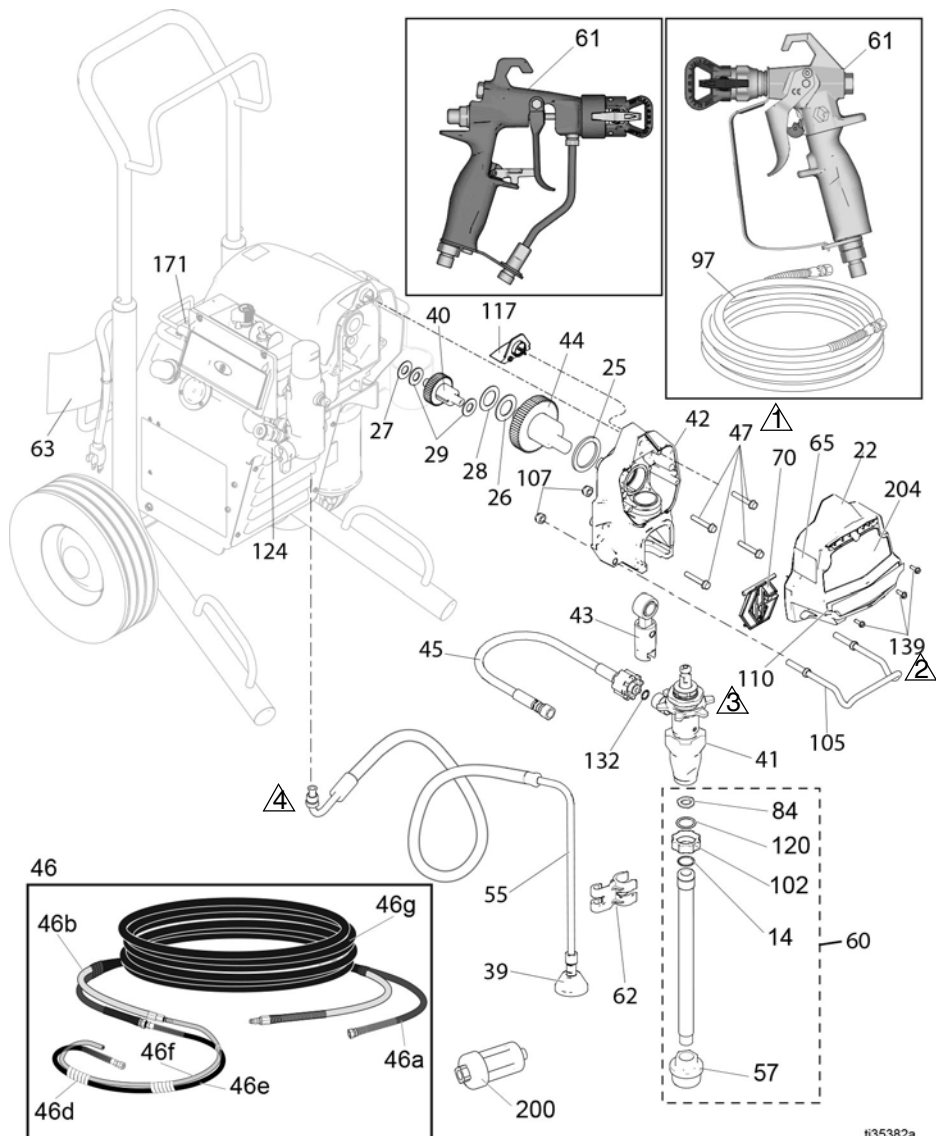

1135382a

Sprayers Parts List

Ref.	Part	Description	Qty.	Ref.	Part	Description	Qty.
12	117501	SCREW, mach, slot hex wash hd	12		16G596	Models 17E913, 17E912	1
14	103413	PACKING, o-ring	1	64	15K053	PLATE, rear, painted	1
22	17C541	COVER, front, painted	1	65▲		LABEL, warning	
23	287900	SHIELD, motor, painted, <i>includes 12</i>	1		16G596	Models 17E913, 17E912	1
25	180131	BEARING, thrust	1		195793	Models 17E915, 17E908	1
26	107434	BEARING, thrust	1	66	287489	HANDLE, assy, hi cart	1
27	116073	WASHER, thrust	1	67	109032	SCREW, mach, pnh	4
28	116074	WASHER, thrust	1	70	17C483	COVER, pump rod	1
29	116079	BEARING, thrust	2	76	15B999	CLIP, retaining	2
39	241920	DEFLECTOR, threaded	1	77	15K052	PLATE, front, painted	1
40	249194	GEAR, reducer	1	78	106062	WHEEL, semi pneumatic	2
41		PUMP, displacement, PC	1	84	115099	WASHER, garden hose	1
	17C487	North America		87	287253	TOOL BOX, <i>includes 88</i>	1
	17C488	Asia/ANZ		88	118852	SCREW, thd forming, hex washer hd	3
	17C489	Europe		94	15K040	NUT, regulator, metal	1
42	24W817	HOUSING, drive, PC <i>includes 12, 70</i>	1	97	240794	HOSE, cpld, 1/4 x 50 ft.	1
43	24W640	ROD, connecting, PC	1	101		TIP, spray, latex RAC X	1
44	24X020	KIT, repair, crankshaft, <i>includes 25</i>	1		LTX517	Models 17E915, 17E908	
45	24W830	KIT, hose, cpld, PC, <i>includes 132</i>	1		PAA517	All other models	
46	24U579	3300 psi hose set, 50 ft. (15.2m) <i>includes 46a, 46b, 46d, 46e, 46f, 46g</i>	1	102	15E813	NUT, jam	1
46a	278764	HOSE, cpld, 1/4 x 50 ft.	1	103	104811	CAP, hub	2
46b	16X433	HOSE, air, 50 ft.	1	105	17C990	HOOK, pail	1
46d	15X843	SLEEVE, wrap, spiral	3	107	111040	NUT, lock, insert, nylock, 5/16	2
46e	278750	HOSE, Nylon, fluid, 6 ft. (1.8m)	1	110	17E952	LABEL, brand, front, FinishPro 595	1
46f	278751	HOSE, whip, air	1	111	17E962	LABEL, brand, side, FinishPro 595	1
46g	24U577	COVER, flex, 50 ft.	1	114	15K468	LABEL, AA, regulator/gauge	1
47	117493	SCREW, mach, hex washer HD	8	116	15K465	LABEL (Models 17E908, 17E915)	1
54	287807	MOTOR, 395 <i>includes 54a, 54b</i>	1	117	15G447	PLUG, tubing	1
54a	15D088	FAN, motor	1	120	15B652	WASHER, suction	1
54b	115477	SCREW, mach, torx, painted	1	124▲	290228	LABEL, caution	1
55	287952	HOSE, drain, Ultra hi-boy, <i>includes 39</i>	1	132	16H137	PACKING, o-ring	1
57	246385	STRAINER, 7/8-14 unf	1	137		KIT, conversion (not shown)	1
59	24U249	FRAME, cart, hi, AA	1		288514	RAC tip to flat tip	
60	17C992	TUBE, suction <i>includes 14, 57, 84, 102, 120</i>	1		24U616	FLAT tip to RAC tip	
61		GUN, assy, AA G40	1	139	127914	SCREW, mach, slot hex	1
	262929	Models 17E908, 17E915	1	148	111909	GROMMET	1
	262932	Models 17E912, 17E913	1	171▲	16D646	LABEL, warning	1
	288420	Model 17E908	1	200	24U981	KIT, in-line desiccant (5 pack)	1
62	276888	CLIP, drain line	1		24U982	KIT, in-line desiccant (25 pack)	1
63▲		LABEL, warning, fire/explosion, skin	1	204	17E961	LABEL, brand, front, FinishPro 595	1
	15H085	Models 17E915, 17E908	1	206994	FLUID, TSL, 8 oz		1

▲ Replacement safety labels, tags, and cards are available at no cost.

Control Box

Control Box

Ref.	Torque
	140-160 in-lb (15.8 - 18.1 N•m)
	30-35 in-lb (3.4 - 4.0 N•m)
	37-43 ft-lb (50.2 - 58.3 N•m)
	130-150 in-lb (14.7 - 16.9 N•m)

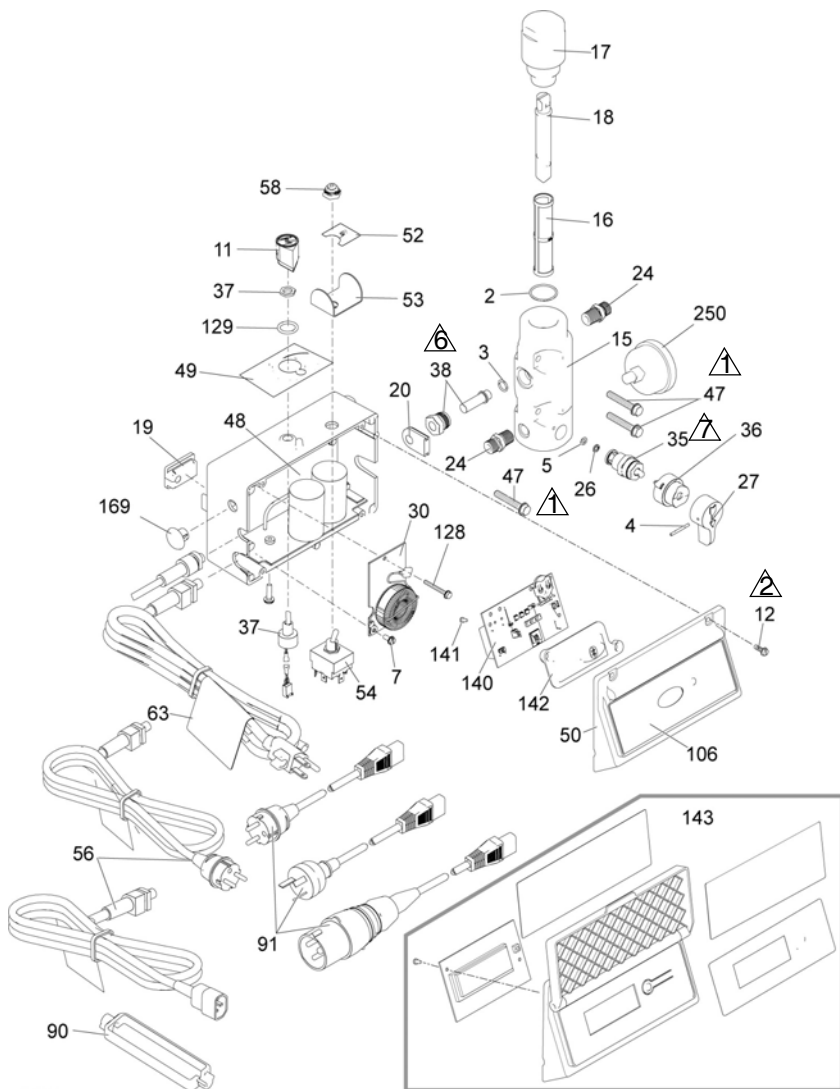

t135383c

Control Box Parts List

Ref. Part	Description	Qty.	Ref. Part	Description	Qty.		
2	117828	PACKING, o-ring	1	49	17P731	LABEL, pressure adjustment, w/FastFlush	1
3	111457	PACKING, o-ring	1				
4	111600	PIN, grooved	1	50	17Y556	COVER, control, BlueLink <i>includes 106</i>	1
5	277364	GASKET, seat, valve	1	52	16X748	LABEL, ON/OFF	1
7	115498	SCREW, slot, hex, wash hd	1	53	16X642	BRACKET, switch	1
11	116167	KNOB, potentiometer	1	54	120544	SWITCH, toggle	1
12	117501	SCREW, mach, hex washer hd	4	56		CORD, power	1
15	15T811	MANIFOLD, fluid	1	15H064		US, 120V	
16		FILTER, fluid	1	16X842		AP and Europe Multicord	
	246425	30 mesh			16X841	CEE 7/7	
	246384	60 mesh, original		58	195428	BOOT, toggle	1
	246382	100 mesh		90	195551	RETAINER, plug, adapter	
	246383	200 mesh				Multicord models	2
17	287902	KIT, repair, filter cap <i>includes 18</i>	1			CEE 7/7 models	1
18	15B071	INSERT, filter	1	91		CORD SET, adapter	1
19	15G562	BUSHING, control box	1		253368	UK	
20	15B120	GROMMET, transducer	1		242001	CEE, Asia/ANZ, EU Multi	
24	162453	NIPPLE, (1/4 npsm x 1/4 npt)	2		242005	Australia	
26	15E022	SEAT, valve	1		287121	Italy, Denmark, Sweden	
27	187625	HANDLE, valve, drain	1	106	17E921	LABEL, smart control	1
35	239914	VALVE, drain <i>includes 5, 26</i>	1	127	120165	SCREW, mach, Phillips, pan hd	1
36	224807	BASE, valve	1	128	120406	SCREW, mach, hex washer hd	1
37	256219	POTENTIOMETER, adj, pressure with nut	1	129	158674	O-RING, packing	1
38	243222	TRANSDUCER, pressure control, <i>includes 3</i>	1	169	16Y457	PLUG, molded	1
47	117493	SCREW, mach, hex washer hd	4	140	‡	BOARD, control, BlueLink	1
48		BOX, control board	1	141	115522	SCREW, mach, pan hd	2
‡	17Z256	Bluetooth, 120V <i>includes 6, 7, 11, 19, 37, 49, 52, 53, 54, 58, 127, 128, 129</i>		142	17Y405	LENS, BlueLink	1
				143		KIT, display, smart control	1
‡	17Z257	Bluetooth, 230V <i>includes 6, 7, 11, 19, 30, 37, 49, 52, 53, 54, 58, 127, 128, 129</i>			24W892	Domestic	
					287904	International	
17D890	Display, 120V <i>includes 6, 7, 11, 19, 37, 49, 52, 53, 54, 58, 127, 128, 129</i>			250	115523	GAUGE, fluid, pressure	1
17D891	Display, 230V <i>includes 6, 7, 11, 19, 30, 37, 49, 52, 53, 54, 58, 127, 128, 129</i>						

* - Use battery CR2032



‡- Control boards (48 & 140) are a matched pair, if separated some BlueLink features will not function.

KIT, ProGuard+, 230V models only (not shown)

24W090 CEE 7/7
24W755 Multicord, IEC-320

Compressor

Compressor

Ref.	Torque
 1	60-85 in-lb (6.8 - 9.6 N•m)
 2	95-100 in-lb (10.7 - 11.3N•m)

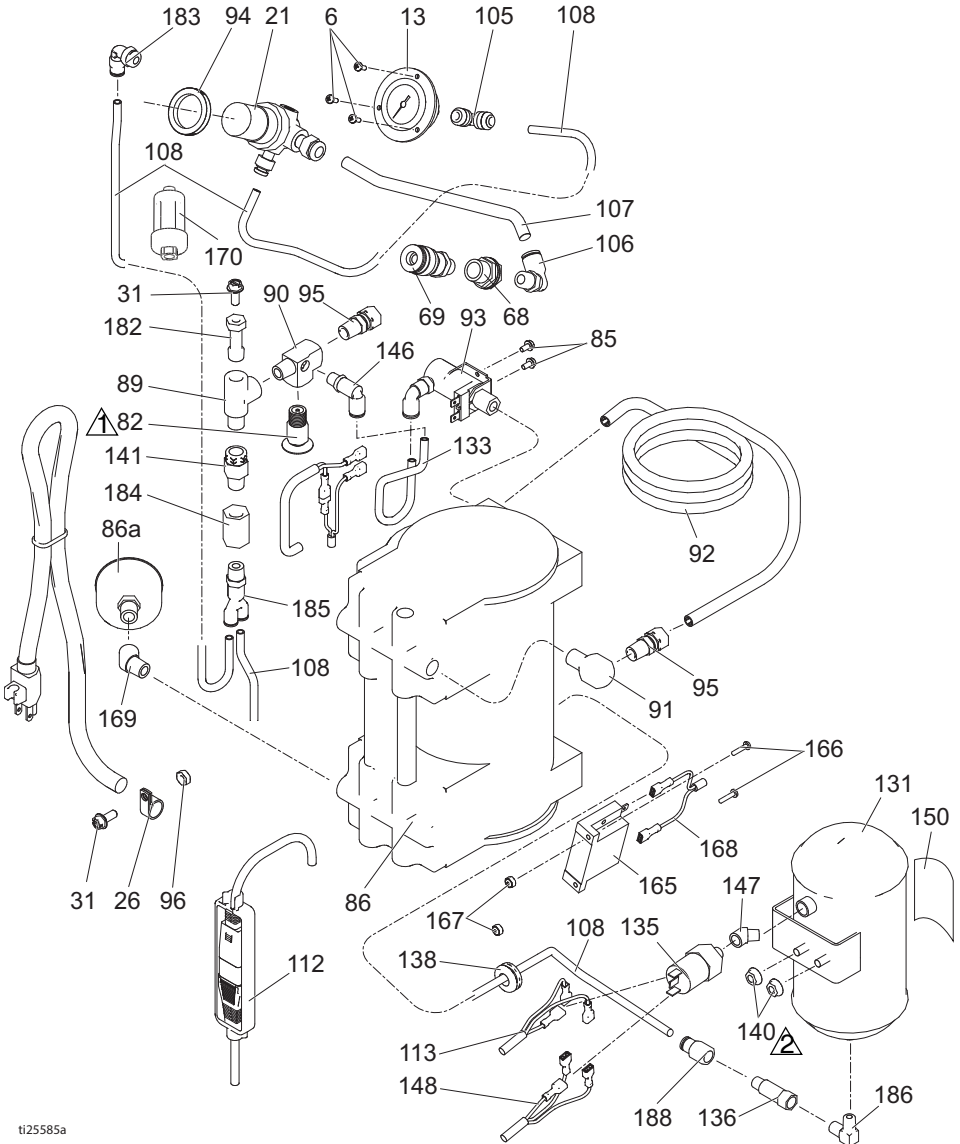

ti25585a

Compressor Parts List

Ref.	Part	Description	Qty.	Ref.	Part	Description	Qty.
6	115494	SCREW, mach, Phillips	3	107	15K391	TUBE, air	1
13	120643	GAUGE, pressure, panel mount, 1.5	1	108	15B822	TUBE, air	2
21	127330	REGULATOR, air, 1/4 in. npt	1	112	195551	RETAINER, plug, adapter	1
26		CLAMP, wire	1	113	16X530	CORD, pwr, comp. female end	1
	113491	Model 17E908		131	16X915	TANK, painted	1
	120143	All other models		133	16X477	HOSE, air	1
31	117633	SCREW, slot hex wash hd	6	135	127343	SWITCH, pressure	1
68	104641	FITTING, bulkhead	1	136	127339	VALVE, check, 1/8 in. mnpt x fnpt	1
69	120963	COUPLE, quick, disconnect	1	138	801012	GROMMET	1
82	122703	VALVE, pressure, relief	1	140	115942	NUT, hex, flange head	2
85	109575	SCREW, threadforming, hexhead	2	141	127340	VALVE, check, 1/4 in. mnpt x fnpt	1
86		AIR COMPRESSOR (includes 86a)		146	597151	FITTING, elbow	3
	288720	Models 17E908	1	147	113630	ELBOW, street 45 degree 1/8 npt	1
	288722	Model 17E912, 17E913, 17E915	1	148	16X827	CORD, compress/control board	1
86a	288724	KIT, compressor, filter	1	150	16X906	LABEL, brand, smart-comp	1
89	106228	FITTING, brass, elbow	1	165	16Y436	TIMER, solid state	
90	16Y589	FITTING, tee	1	166	125483	SCREW, mach, pnh, sems, phillips	2
91	187357	ELBOW, street	1	167	C19862	NUT, lock, hex	2
92	16X397	TUBE, heat exchange, 395/595	1	168	16Y442	CORD, compressor to timer	1
93		SOLENOID, 2 way, norm open	1	169	113444	FITTING, elbow, street	1
	16X399	Model 17E908	1	170	127465	FILTER, in-line, desiccant	1
	16X526	Model 17E912, 17E913, 17E915	1	182	17B227	FITTING, stand-off	1
94	15K040	NUT, regulator, metal	1	183	114109	FITTING, elbow, male	1
95	120732	FITTING, compression, male connect	2	184	113093	CONNECTOR, pipe	1
96	100015	NUT, hex mscr	1	185	127716	CONNECTOR, Y, male	1
105	120653	FITTING, push to conn	1	186	110207	ELBOW, pipe	1
106	120753	FITTING, push to connect elbow	1	188	114320	FITTING, connector, female	1

Wiring Diagrams

120V

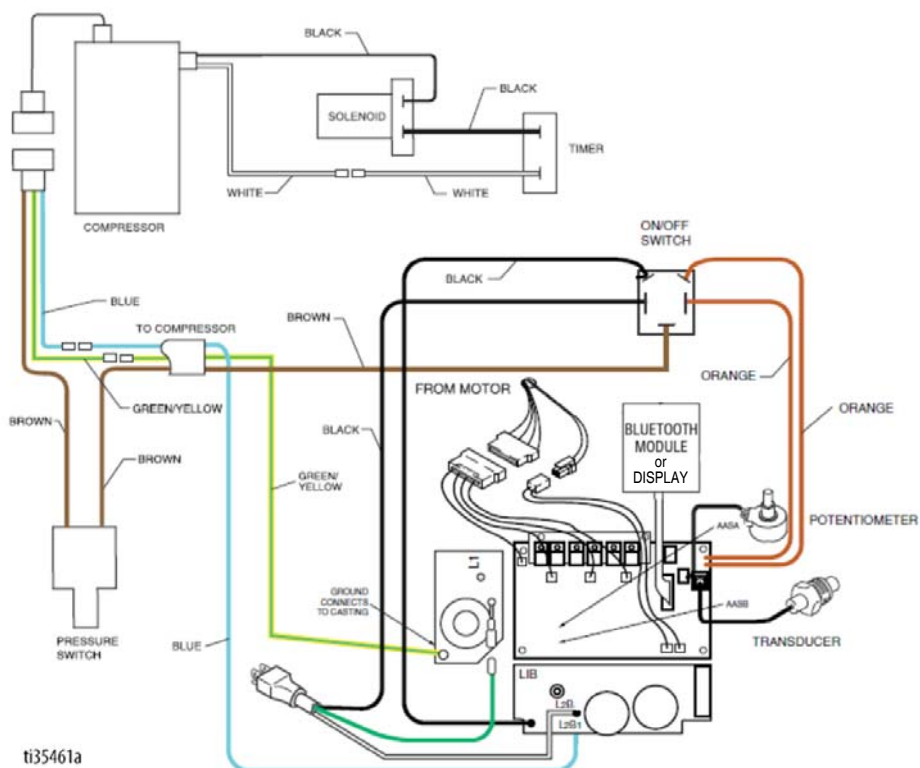

Battery Replacement

Battery Replacement

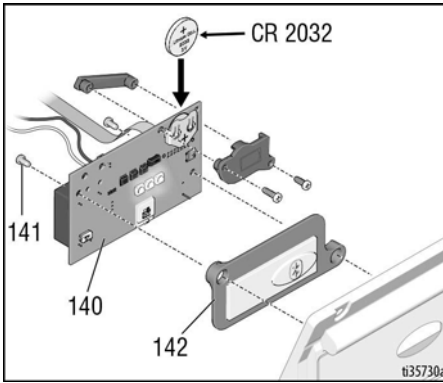

Technical Specifications

FinishPro II 595 PC Pro		
	US	Metric
Sprayer		
Power requirements	★100/120V AC, 50/60 Hz, 15A, 1Ø	◆ 230V AC, 50/60 Hz, 10A, 1Ø
Generator Minimum	4000 W	
Max tip size		
US ★ / Europe ◆ / Asia/Australia ◆	0.027	0.027
Max material output gpm (lpm)		
US ★ / UK★	0.70 gpm	2.6 lpm
Europe ◆ / Asia/Australia ◆	0.70 gpm	2.6 lpm
Maximum material pressure - Airless		
US ★	3300 psi	227 bar
UK★	2800 psi	193 bar
Europe ◆ / Asia/Australia ◆	3300 psi	227 bar
Maximum material pressure - AA		
US ★ / UK★	2800 psi	193 bar
Europe ◆ / Asia/Australia ◆	3300 psi	227 bar
Atomizing air output		
US★ / UK★	3.2 cfm	3.2 cfm
Europe / Asia/Australia	2.9 cfm	2.9 cfm
Air pressure	35 psi	2.4 bar
Dimensions		
Length	32.5 in.	82.5 cm
Width	21 in.	53.3 cm
Height	40.5 in.	102.8 cm
Weight (bare)	112 lb	50.8 kg
Noise** (dBA) @ 70 psi (0.48 MPa, 4.8 bar)		
Sound pressure	79 dBA	
Sound power	96 dBA	
Materials of Construction		
Pump motor	1.4 HP Brushless	1.4 HP Brushless
Compressor motor	1.0 HP AC Induction	1.0 HP AC Induction
Material hose	1/4 in. x 50-ft (blue)	1/4 in. x 15.2 m (blue)
Air hose	3/8 in. x 50-ft (clear)	3/8 in. x 15.2 m (clear)
Gun	G40 w RAC X tip	G40 w RAC X tip
Wetted materials on all models	zinc- and nickel-plated carbon steel, nylon, stainless steel, PTFE, Acetal, leather, UHMWPE, aluminum, tungsten carbide, polyethylene, fluoroelastomer, urethane	
Notes		
* Startup pressures and displacement per cycle may vary based on suction condition, discharge head, air pressure, and fluid type.		
** Sound pressure measured 3 feet (1 meter) from equipment.		
Sound power measured per ISO-3741.		
All trademarks or registered trademarks are the property of their respective owners.		

Compliance

Radio Frequency Approvals

Transmitter Frequency (all models): 2.4GHz
Transmitter Power (all models): +8dBm

NOTE: FCC/IC Notice (all models)
Contains FCC ID: QOQBGM13P
Contains IC: 5123A-BGM13P

The enclosed device complies with Part 15 of the FCC Rules and with Industry Canada license-exempt RSS standard(s). Operation is subject to the following two conditions:(1) this device may not cause harmful interference and (2) this device must accept any interference received, including interference that may cause undesired operation.

Changes or modifications not expressly approved by the party responsible for compliance could void the user's authority to operate the equipment.

This equipment is not granted protection against harmful interference and cannot cause interference on systems properly authorized.

This equipment has the board BGM13P22A with homologation code ANATEL 01330-19-03402.



California Proposition 65



WARNING: This product can expose you to chemicals known to the State of California to cause cancer and birth defects or other reproductive harm. For more information go to www.P65Warnings.ca.gov.

Graco Standard Warranty

Graco warrants all equipment referenced in this document which is manufactured by Graco and bearing its name to be free from defects in material and workmanship on the date of sale to the original purchaser for use. With the exception of any special, extended, or limited warranty published by Graco, Graco will, for a period of twelve months from the date of sale, repair or replace any part of the equipment determined by Graco to be defective. This warranty applies only when the equipment is installed, operated and maintained in accordance with Graco's written recommendations.

This warranty does not cover, and Graco shall not be liable for general wear and tear, or any malfunction, damage or wear caused by faulty installation, misapplication, abrasion, corrosion, inadequate or improper maintenance, negligence, accident, tampering, or substitution of non-Graco component parts. Nor shall Graco be liable for malfunction, damage or wear caused by the incompatibility of Graco equipment with structures, accessories, equipment or materials not supplied by Graco, or the improper design, manufacture, installation, operation or maintenance of structures, accessories, equipment or materials not supplied by Graco.

This warranty is conditioned upon the prepaid return of the equipment claimed to be defective to an authorized Graco distributor for verification of the claimed defect. If the claimed defect is verified, Graco will repair or replace free of charge any defective parts. The equipment will be returned to the original purchaser transportation prepaid. If inspection of the equipment does not disclose any defect in material or workmanship, repairs will be made at a reasonable charge, which charges may include the costs of parts, labor, and transportation.

THIS WARRANTY IS EXCLUSIVE, AND IS IN LIEU OF ANY OTHER WARRANTIES, EXPRESS OR IMPLIED, INCLUDING BUT NOT LIMITED TO WARRANTY OF MERCHANTABILITY OR WARRANTY OF FITNESS FOR A PARTICULAR PURPOSE.

Graco's sole obligation and buyer's sole remedy for any breach of warranty shall be as set forth above. The buyer agrees that no other remedy (including, but not limited to, incidental or consequential damages for lost profits, lost sales, injury to person or property, or any other incidental or consequential loss) shall be available. Any action for breach of warranty must be brought within two (2) years of the date of sale.

GRACO MAKES NO WARRANTY, AND DISCLAIMS ALL IMPLIED WARRANTIES OF MERCHANTABILITY AND FITNESS FOR A PARTICULAR PURPOSE, IN CONNECTION WITH ACCESSORIES, EQUIPMENT, MATERIALS OR COMPONENTS SOLD BUT NOT MANUFACTURED BY GRACO. These items sold, but not manufactured by Graco (such as electric motors, switches, hose, etc.), are subject to the warranty, if any, of their manufacturer. Graco will provide purchaser with reasonable assistance in making any claim for breach of these warranties.

In no event will Graco be liable for indirect, incidental, special or consequential damages resulting from Graco supplying equipment hereunder, or the furnishing, performance, or use of any products or other goods sold hereto, whether due to a breach of contract, breach of warranty, the negligence of Graco, or otherwise.

FOR GRACO CANADA CUSTOMERS

The Parties acknowledge that they have required that the present document, as well as all documents, notices and legal proceedings entered into, given or instituted pursuant hereto or relating directly or indirectly hereto, be drawn up in English. Les parties reconnaissent avoir convenu que la rédaction du présente document sera en Anglais, ainsi que tous documents, avis et procédures judiciaires exécutés, donnés ou intentés, à la suite de ou en rapport, directement ou indirectement, avec les procédures concernées.

Graco Information

For the latest information about Graco products, visit www.graco.com.

For patent information, see www.graco.com/patents.

TO PLACE AN ORDER, contact your Graco distributor or call 1-800-690-2894 to identify the nearest distributor.



All written and visual data contained in this document reflects the latest product information available at the time of publication.

Graco reserves the right to make changes at any time without notice.

Original instructions. This manual contains English. MM 3A6564

Graco Headquarters: Minneapolis

International Offices: Belgium, China, Japan, Korea

GRACO INC. AND SUBSIDIARIES • P.O. BOX 1441 • MINNEAPOLIS MN 55440-1441 • USA

Copyright 2019, Graco Inc. All Graco manufacturing locations are registered to ISO 9001.

www.graco.com

Revision D, September 2021