

Electric Airless Sprayers

334567P

EN

For professional use only. Not approved for use in explosive atmospheres or hazardous (classified) locations. For portable airless spraying of architectural paints and coatings.

190/290/390 PC Classic Models:

3000 psi (207 bar, 20.7 MPa) Maximum Working Pressure

3300 psi (228 bar, 22.8 MPa) Maximum Working Pressure

See page 3 for additional model information.



Important Safety Instructions

Read all warnings and instructions in this manual and related manuals before using the equipment. Be familiar with the controls and the proper usage of the equipment. Save these instructions.

Related Manuals

**Gun – 311861 (Contractor/FTx) 312830 (SG3)
3A6285 (Contractor PC)**

Pump – 334599

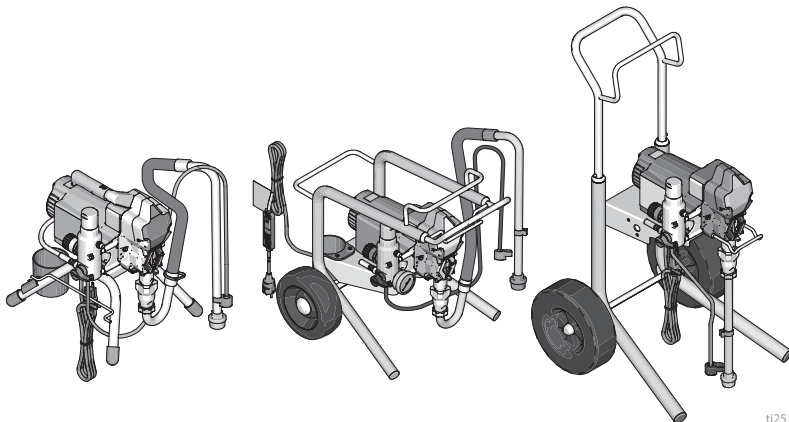







t125126a

*Use only genuine Graco replacement parts.
The use of non-Graco replacement parts may void warranty.*

Contents

Models	3
Warnings	4
Component Identification	8
Stand Models	8
Lo-Boy Models	9
Hi-Boy Models	10
Grounding	11
Power Requirements	11
Extension Cords	11
Pails	11
Pressure Relief Procedure	12
Trigger Lock	13
Setup	14
Startup	17
Operation	19
Spray Tip Installation	19
Spray	19
Clear Tip Clog	20
Cleanup	21
Maintenance	24
Troubleshooting	25
Mechanical/Fluid Flow	25
Electrical	28
Sprayers Parts	32
190, 290, 390 Stand Sprayers Parts List	34
390 Lo-Boy Sprayer Parts	35
390 Lo-Boy Sprayer Parts List	37
190, 290, 390 Hi-Boy Sprayers Parts	38
190, 290, 390 Hi-Boy Sprayers Parts List	40
Accessories and Labels	41
Control Box and Filter	42
Control and Filter Parts List	43
Control and Filter Parts List	44
Wiring Diagrams	45
110/120V	45
110V UK	46
230V	47
Technical Specifications	48
California Proposition 65	49
Graco Standard Warranty	50
Graco Information	51

Models

	VAC	Model	Stand 	Lo-Boy 	Hi-Boy 
 Intertek 110474 Certified to CAN/CSA C22.2 No. 68 Conforms to UL 1450	120 USA	390 PC	17C310		17C313
		NOVA 390 PC	826195		
	120 Mexico/Central America	190 PC Express	17D899		
		190 PC Express with Jetroller	17C121		
	230 South America	190 PC Express	17D900		
		190 PC Express with Jetroller	17C120		
	230 CEE 7/7	190 PC Express	17D901		
		190 PC Express with Jetroller	17C122		
		190 PC Classic	17C438		17C342
		290 PC Classic	17C344		17C343
	230 Europe Multi	390 PC Classic	17C348		17C349
		390 PC Classic	17C346		17C351
110 UK	190 PC Classic	17C341			
	290 PC Classic	18C268			
	390 PC Classic	17C347		17C350	
	100 Japan/Taiwan	390 PC	17C385		
	230 Asia/ANZ	190 PC Express	17C384		
		390 PC	17C386	17C387	17C388
	230 China	390 PC Classic	17C389		

Warnings

The following warnings are for the setup, use, grounding, maintenance, and repair of this equipment. The exclamation point symbol alerts you to a general warning and the hazard symbols refer to procedure-specific risks. When these symbols appear in the body of this manual or on warning labels, refer back to these Warnings. Product-specific hazard symbols and warnings not covered in this section may appear throughout the body of this manual where applicable.

WARNING



GROUNDING

This product must be grounded. In the event of an electrical short circuit, grounding reduces the risk of electric shock by providing an escape wire for the electric current. This product is equipped with a cord having a grounding wire with an appropriate grounding plug. The plug must be plugged into an outlet that is properly installed and grounded in accordance with all local codes and regulations.

- Improper installation of the grounding plug is able to result in a risk of electric shock.
- When repair or replacement of the cord or plug is required, do not connect the grounding wire to either power terminal.
- The wire with insulation having an outer surface that is green with or without yellow stripes is the grounding wire.
- Check with a qualified electrician or serviceman when the grounding instructions are not completely understood, or when in doubt as to whether the product is properly grounded.
- Do not modify the plug provided; if it does not fit the outlet, have the proper outlet installed by a qualified electrician.
- This product is for use on a nominal 110V, 120V, or 230V circuit and has a grounding plug similar to the plugs illustrated below.

110V UK



120V US



230V

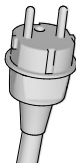

230V ANZ



ti24583a

- Only connect the product to an outlet having the same configuration as the plug.
- Do not use an adapter with this product.

Extension Cords:

- Use only a 3-wire extension cord that has a grounding plug and a grounding receptacle that accepts the plug on the product.
- Make sure your extension cord is not damaged. If an extension cord is necessary use 12 AWG (2.5mm²) minimum to carry the current that the product draws.
- An undersized cord results in a drop in line voltage and loss of power and overheating.

WARNING
FIRE AND EXPLOSION HAZARD

Flammable fumes, such as solvent and paint fumes, in work area can ignite or explode. To help prevent fire and explosion:

- Do not spray flammable or combustible materials near an open flame or sources of ignition such as cigarettes, motors, and electrical equipment.
- Paint or solvent flowing through the equipment is able to result in static electricity. Static electricity creates a risk of fire or explosion in the presence of paint or solvent fumes. All parts of the spray system, including the pump, hose assembly, spray gun, and objects in and around the spray area shall be properly grounded to protect against static discharge and sparks. Use Graco conductive or grounded high-pressure airless paint sprayer hoses.
- Verify that all containers and collection systems are grounded to prevent static discharge. Do not use pail liners unless they are antistatic or conductive.
- Connect to a grounded outlet and use grounded extensions cords. Do not use a 3-to-2 adapter.
- Do not use a paint or a solvent containing halogenated hydrocarbons.
- Do not spray flammable or combustible liquids in a confined area.
- Keep spray area well-ventilated. Keep a good supply of fresh air moving through the area.
- Sprayer generates sparks. Keep pump assembly in a well ventilated area at least 20 feet (6.1 m) from the spray area when spraying, flushing, cleaning, or servicing. Do not spray pump assembly.
- Do not smoke in the spray area or spray where sparks or flame is present.
- Do not operate light switches, engines, or similar spark producing products in the spray area.
- Keep area clean and free of paint or solvent containers, rags, and other flammable materials.
- Know the contents of the paints and solvents being sprayed. Read all Safety Data Sheets (SDS) and container labels provided with the paints and solvents. Follow the paint and solvents manufacturer's safety instructions.
- Keep a working fire extinguisher in the work area.

Warnings

WARNING

SKIN INJECTION HAZARD



High-pressure spray is able to inject toxins into the body and cause serious bodily injury. In the event that injection occurs, **get immediate surgical treatment**.



- Do not aim the gun at, or spray any person or animal.
- Keep hands and other body parts away from the discharge. For example, do not try to stop leaks with any part of the body.



- Always use the spray tip guard. Do not spray without spray tip guard in place.



- Use Graco spray tips.
- Use caution when cleaning and changing spray tips. In the case where the spray tip clogs while spraying, follow the **Pressure Relief Procedure**, page 12, for turning off the unit and relieving the pressure before removing the spray tip to clean.



- Equipment maintains pressure after power is shut off. Do not leave the equipment energized or under pressure while unattended. Follow the **Pressure Relief Procedure**, page 12, when the equipment is unattended or not in use, and before servicing, cleaning, or removing parts.

- Check hoses and parts for signs of damage. Replace any damaged hoses or parts.
- This system is capable of producing 3300 psi (228 bar, 22.8 MPa). Use Graco replacement parts or accessories that are rated a minimum of 3300 psi (228 bar, 22.8 MPa).
- Always engage the trigger lock when not spraying. Verify the trigger lock is functioning properly.
- Verify that all connections are secure before operating the unit.
- Know how to stop the unit and bleed pressure quickly. Be thoroughly familiar with the controls.









EQUIPMENT MISUSE HAZARD

Misuse can cause death or serious injury.



- Always wear appropriate gloves, eye protection, and a respirator or mask when painting.
- Do not operate or spray near children. Keep children away from equipment at all times.
- Do not overreach or stand on an unstable support. Keep effective footing and balance at all times.
- Stay alert and watch what you are doing.
- Do not operate the unit when fatigued or under the influence of drugs or alcohol.
- Do not kink or over-bend the hose.
- Do not expose the hose to temperatures or to pressures in excess of those specified by Graco.
- Do not use the hose as a strength member to pull or lift the equipment.
- Do not spray with a hose shorter than 25 feet.
- Do not alter or modify equipment. Alterations or modifications may void agency approvals and create safety hazards.
- Make sure all equipment is rated and approved for the environment in which you are using it.

WARNING

 	<p>ELECTRIC SHOCK HAZARD</p> <p>This equipment must be grounded. Improper grounding, setup, or usage of the system can cause electric shock.</p> <ul style="list-style-type: none"> • Turn off and disconnect power cord before servicing equipment. • Connect only to grounded electrical outlets. • Use only 3-wire extension cords. • Ensure ground prongs are intact on power and extension cords. • Do not expose to rain. Store indoors.
	<p>PRESSURIZED ALUMINUM PARTS HAZARD</p> <p>Use of fluids that are incompatible with aluminum in pressurized equipment can cause serious chemical reaction and equipment rupture. Failure to follow this warning can result in death, serious injury, or property damage.</p> <ul style="list-style-type: none"> • Do not use 1, 1, 1-trichloroethane, methylene chloride, other halogenated hydrocarbon solvents or fluids containing such solvents. • Do not use chlorine bleach. • Many other fluids may contain chemicals that can react with aluminum. Contact your material supplier for compatibility.
 	<p>MOVING PARTS HAZARD</p> <p>Moving parts can pinch, cut, or amputate fingers and other body parts.</p> <ul style="list-style-type: none"> • Keep clear of moving parts. • Do not operate equipment with protective guards or covers removed. • Equipment can start without warning. Before checking, moving, or servicing equipment, follow the Pressure Relief Procedure, page 12, and disconnect all power sources.
	<p>TOXIC FLUID OR FUMES HAZARD</p> <p>Toxic fluids or fumes can cause serious injury or death if splashed in the eyes or on skin, inhaled, or swallowed.</p> <ul style="list-style-type: none"> • Read Safety Data Sheets SDSs to know the specific hazards of the fluids you are using. • Store hazardous fluid in approved containers, and dispose of it according to applicable guidelines.
	<p>PERSONAL PROTECTIVE EQUIPMENT</p> <p>Wear appropriate protective equipment when in the work area to help prevent serious injury, including eye injury, hearing loss, inhalation of toxic fumes, and burns. This protective equipment includes but is not limited to:</p> <ul style="list-style-type: none"> • Protective eyewear, and hearing protection. • Respirators, protective clothing, and gloves as recommended by the fluid and solvent manufacturer.

Component Identification

Component Identification

Stand Models

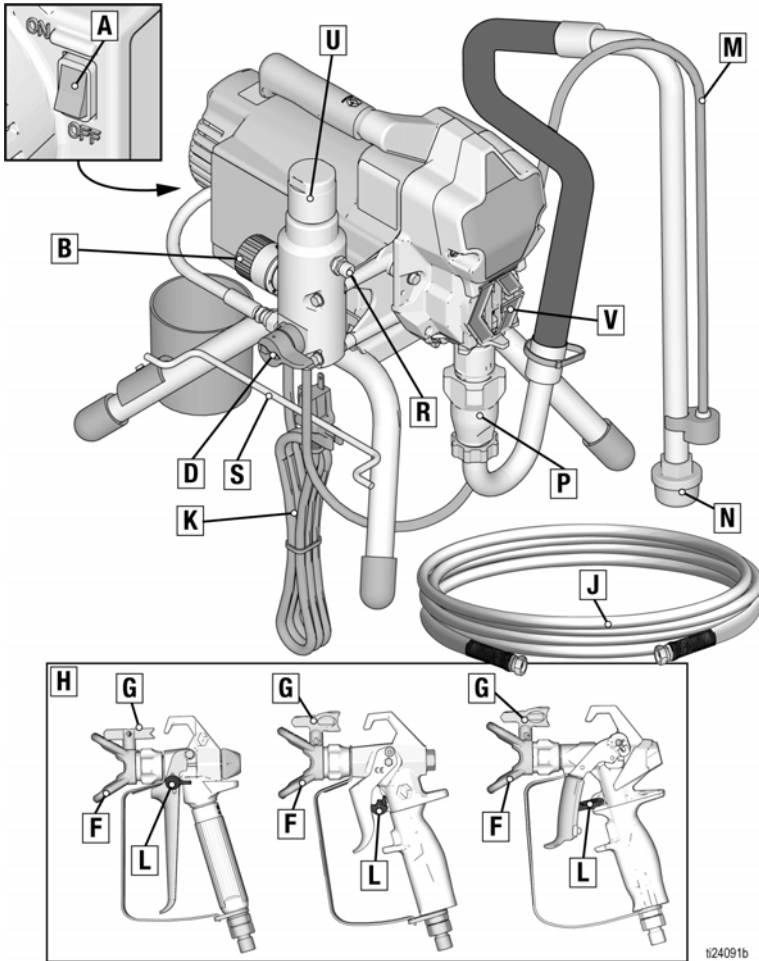

024091b

A	ON/OFF Switch
B	Pressure Control
D	Prime Valve
F	Tip Guard
G	Spray Tip
H	Gun
J	Airless Hose
K	Power Cord
L	Trigger Lock

M	Drain Tube
N	Fluid Intake
P	Pump
R	Fluid Outlet
S	Power Cord Wrap
U	Filter
V	Finger Guard / TSL Fill Point
	Model/Serial Tag (Not shown, located on bottom of unit.)

Component Identification

Lo-Boy Models

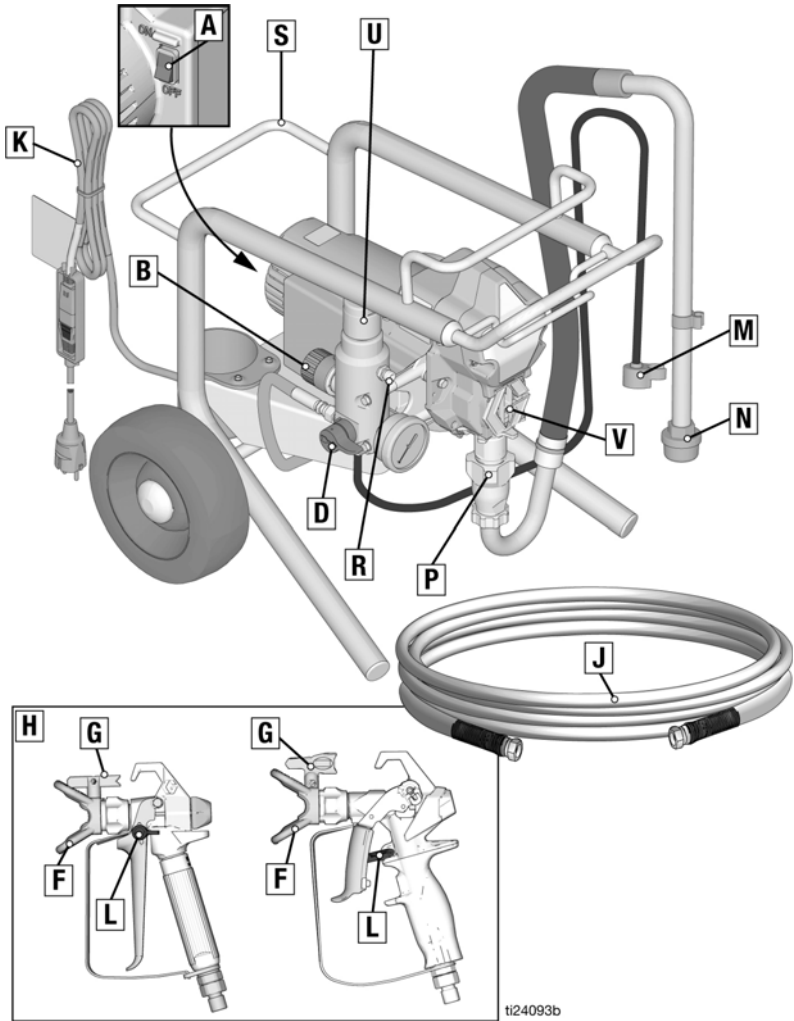

A	ON/OFF Switch
B	Pressure Control
D	Prime Valve
F	Tip Guard
G	Spray Tip
H	Gun
J	Airless Hose
K	Power Cord

L	Trigger Lock
M	Drain Tube
N	Fluid Intake
P	Pump
R	Fluid Outlet
U	Filter
V	Finger Guard / TSL Fill Point
	Model/Serial Tag (Not shown, located on bottom of unit.)

Component Identification

Hi-Boy Models

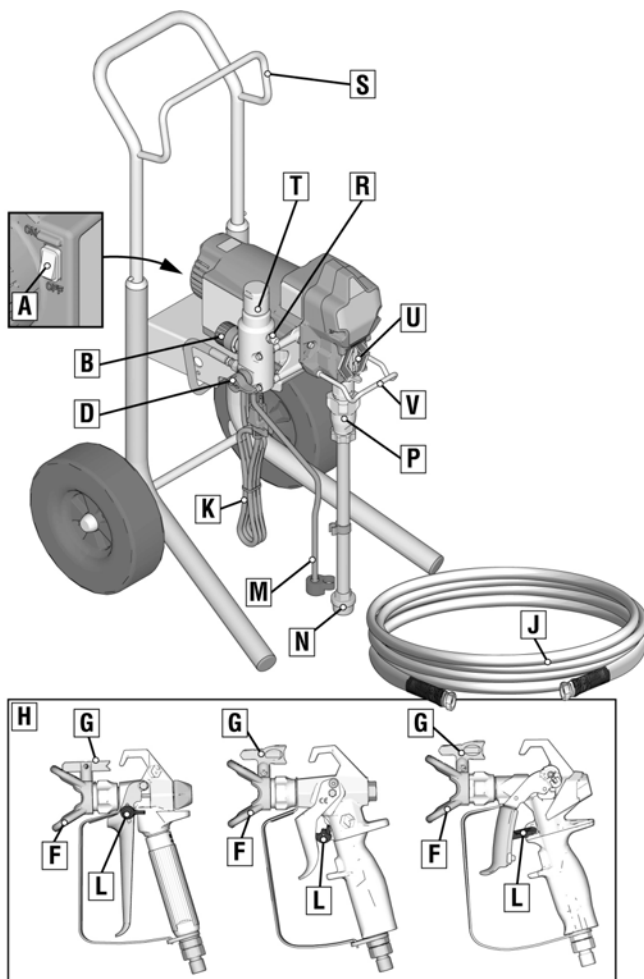

ti24092b

A	ON/OFF Switch
B	Pressure Control
D	Prime Valve
F	Tip Guard
G	Spray Tip
H	Gun
J	Airless Hose
K	Power Cord
L	Trigger Lock

M	Drain Tube
N	Fluid Intake
P	Pump
R	Fluid Outlet
S	Hanger
T	Filter
U	Finger Guard / TSL Fill Point
V	Pail Hook
	Model/Serial Tag (Not shown, located on bottom of unit.)

Grounding



The equipment must be grounded to reduce the risk of static sparking and electric shock. An electric or static spark can cause fumes to ignite or explode. An improper ground can cause electric shock. A good ground provides an escape wire for the electric current.

This sprayer is equipped with a Power Cord that has a ground wire and an appropriate grounding plug.

The plug must be plugged into an outlet that is properly installed and grounded in accordance with all local codes and ordinances.

Do not modify the plug provided; if it does not fit the outlet, have the proper outlet installed by a qualified electrician.

Power Requirements

- 110-120V units require 100-120 VAC, 50/60 Hz, 13A, 1 phase.
- 230V units require 230 VAC, 50/60 HZ, 8A, 1 phase.

Extension Cords

Use an extension cord with an undamaged ground contact. If an extension cord is necessary, use a 3-wire, 12 AWG (2.5 mm²) minimum.

NOTE: Smaller gauge or longer extension cords may reduce sprayer performance.

Pails

Solvent and oil-based fluids: follow local code. Use only conductive metal pails, placed on a grounded surface such as concrete.

Do not place pail on a non-conductive surface such as paper or cardboard which interrupts grounding continuity.

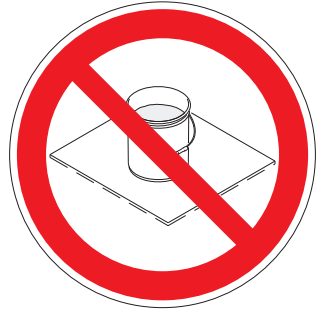

Always ground a metal pail: connect a ground wire to the pail. Clamp one end to the pail and the other end to a true earth ground such as a water pipe.

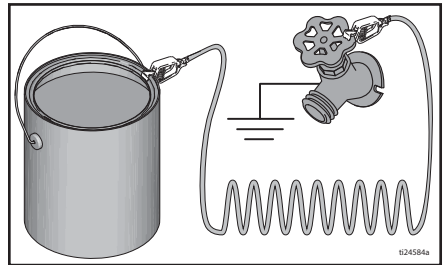

To maintain ground continuity when sprayer is flushed or pressure is relieved: hold metal part of spray gun firmly to the side of a grounded metal pail then trigger the gun.

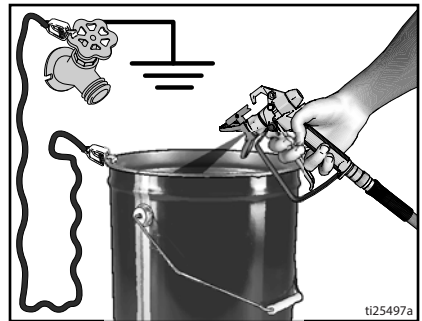

Pressure Relief Procedure

Pressure Relief Procedure



Follow the Pressure Relief Procedure whenever you see this symbol.

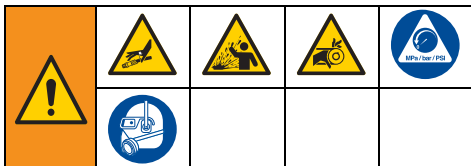

This equipment stays pressurized until pressure is manually relieved. To help prevent serious injury from pressurized fluid, such as skin injection, splashed fluid and moving parts, follow the Pressure Relief Procedure whenever sprayer is stopped and before sprayer is cleaned or checked, and before equipment is serviced.

1. Turn the ON/OFF switch to the **OFF** position. Wait 7 seconds for power to dissipate.

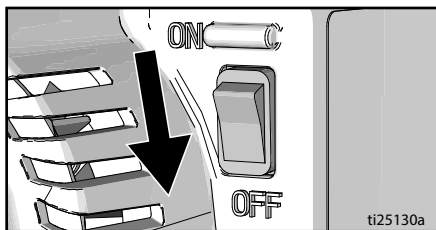

2. Engage the trigger lock.

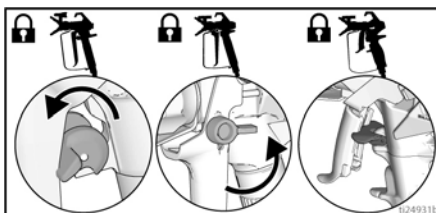

3. Turn pressure control to lowest setting. Disengage the trigger lock.

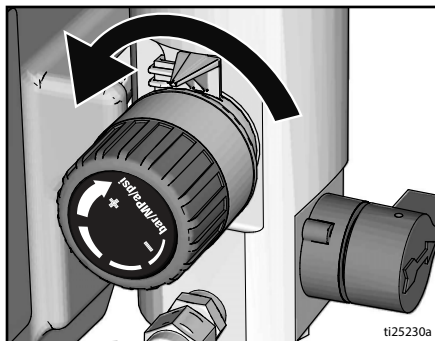

4. Hold a metal part of the gun firmly to a grounded metal pail. Trigger the gun to relieve pressure.

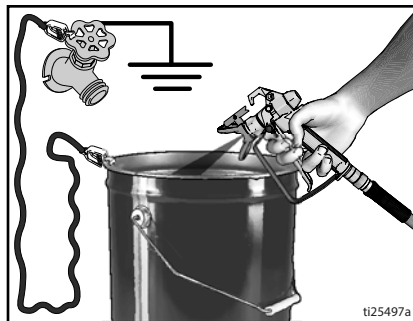

5. Engage the trigger lock.

Pressure Relief Procedure

- Put drain tube in a pail. Turn prime valve down. Leave prime valve in down (drain) position until you are ready to spray again.

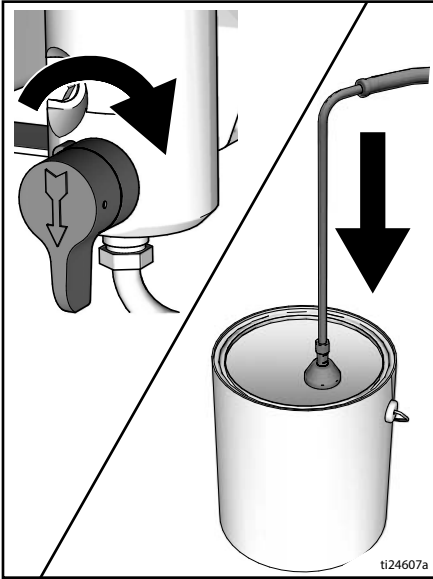

- If you suspect the spray tip or hose is clogged or that pressure has not been fully relieved:

- VERY SLOWLY loosen the tip guard retaining nut or the hose end coupling to relieve pressure gradually.
- Loosen the nut or coupling completely.
- Clear hose or tip obstruction.

Trigger Lock

Always engage the trigger lock when sprayer is stopped to prevent the gun from being triggered accidentally by hand or if dropped or bumped.

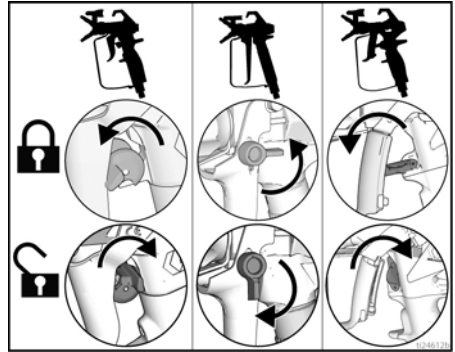

Setup

Setup

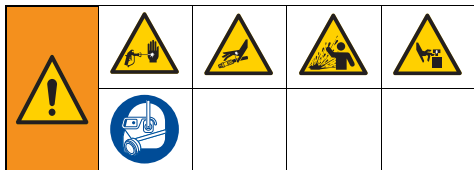

When unpacking sprayer for the first time or after long term storage perform setup procedure. When first setup is performed remove shipping plug from fluid outlet.

1. Connect Graco airless hose to fluid outlet. Use wrenches to tighten securely.

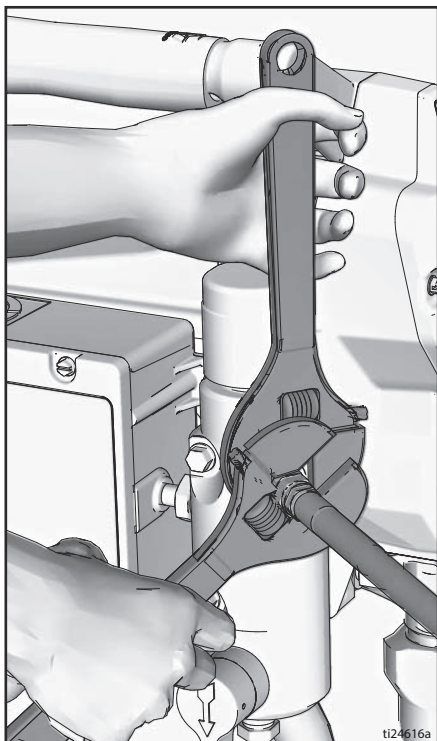

2. Connect other end of hose to gun.

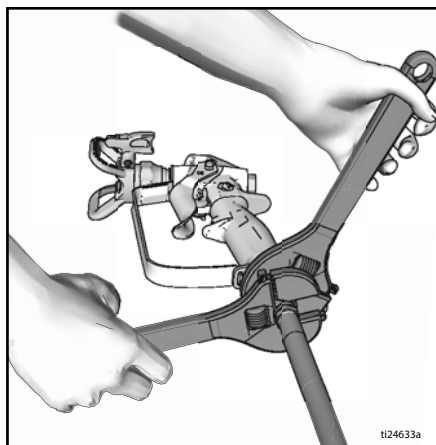

3. Use wrenches to tighten securely.
4. Engage trigger lock.

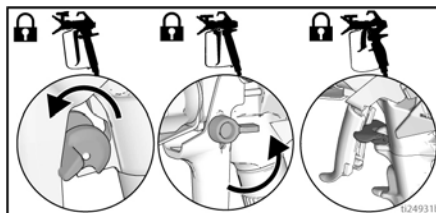

- Remove tip guard.

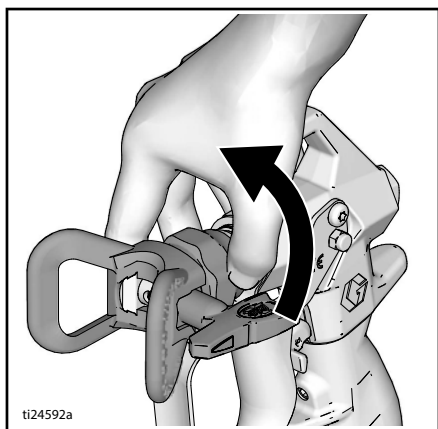

- When unpacking sprayer for the first time remove packaging materials from inlet strainer. After long term storage check inlet strainer for clogs and debris.

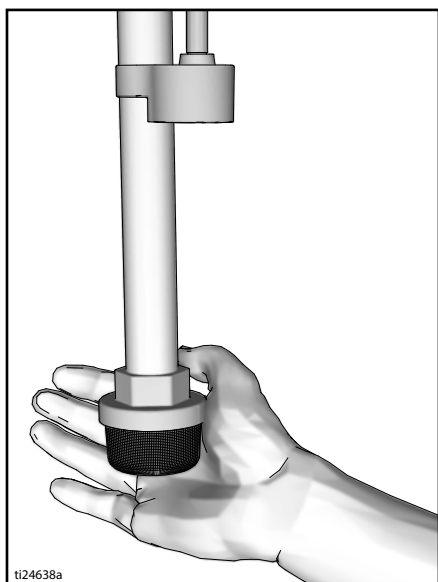

- Fill throat packing nut with TSL to prevent premature packing wear. Do this daily or each time you spray.

- Place the TSL bottle nozzle into the top center opening in the grill at the front of the sprayer.
- Squeeze bottle to dispense enough TSL to fill the space between the pump rod and packing nut seal.

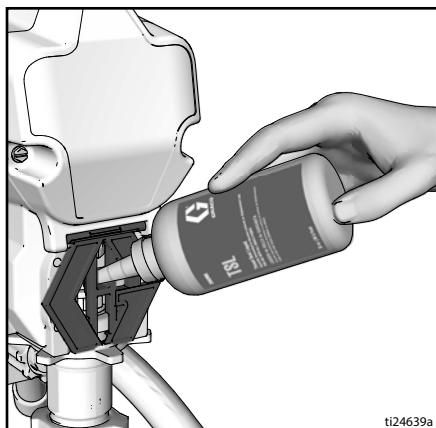

- Make certain ON/OFF switch is OFF.

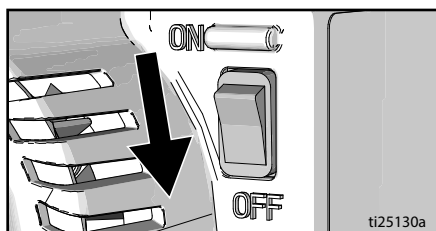

- Plug power supply cord into a properly grounded electrical outlet.

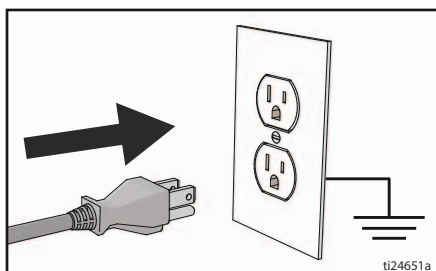

Setup

10. Turn prime valve down.

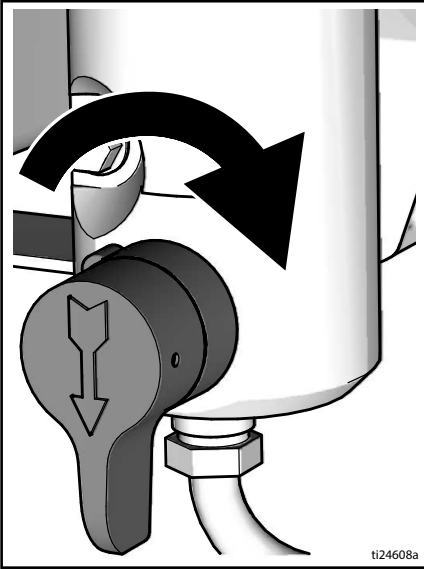

11. Place fluid intake with drain tube in grounded metal pail partially filled with flushing fluid. See **Grounding**, page 11.

NOTE: New sprayers are shipped with storage fluid that must be flushed out with mineral spirits prior to using the sprayer.

Check flushing fluid for compatibility with material that is to be sprayed. A secondary flush with a compatible fluid may be necessary. Water for latex paint or mineral spirits for oil-based paint.

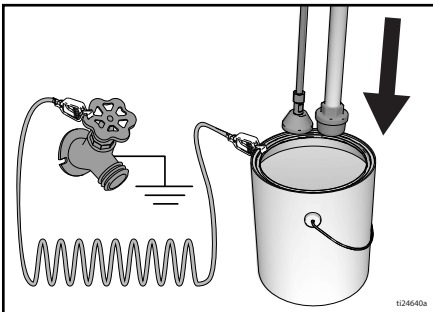

12. Turn pressure control to lowest setting.
13. Turn ON/OFF switch to **ON** position.
14. Increase pressure 1/2 turn to start motor. Allow fluid to flush through sprayer for one minute.
15. Turn prime valve horizontal. Disengage trigger lock.

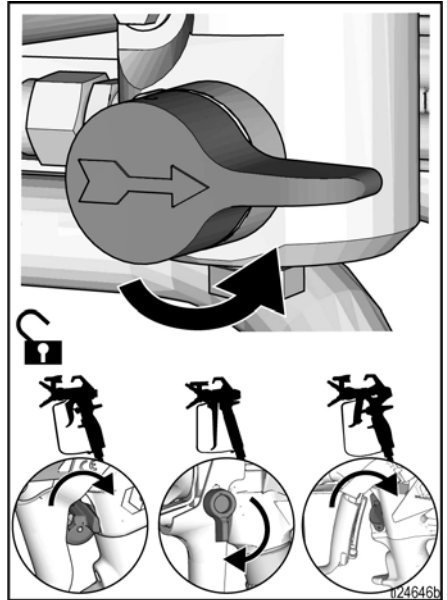

16. Hold a metal part of the gun firmly to a grounded metal pail. Trigger gun and flush until clean.
17. Turn ON/OFF switch to **OFF** position.
18. Engage trigger lock.
19. If the initial flushing fluid is not compatible with the paint that is to be sprayed, a second flush is needed. Repeat steps 11-18.
20. Sprayer is now ready to start up and spray.

Startup

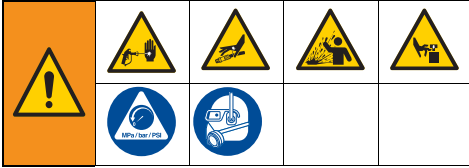

1. Perform **Pressure Relief Procedure**, page 12.
2. Turn pressure control to lowest pressure.

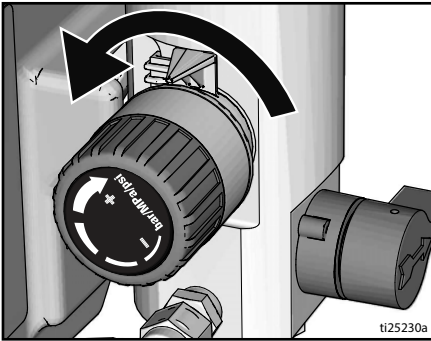

3. Turn ON/OFF switch to **ON** position.

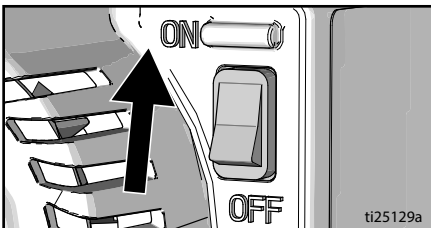

4. Place fluid intake in paint pail. Place drain tube in waste pail.

5. Increase pressure 1/2 turn to start motor. Allow paint to circulate through sprayer until paint flows out the drain tube.

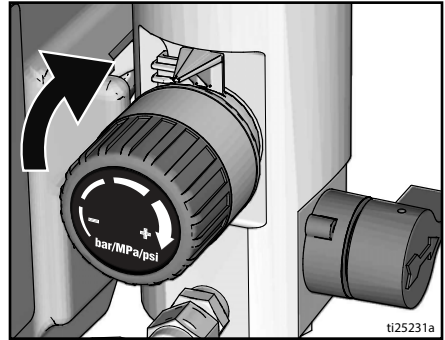

6. Turn prime valve horizontal. Disengage trigger lock.

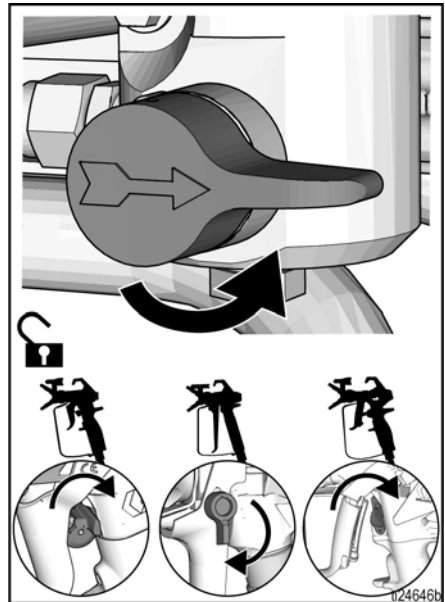

Startup

7. Hold gun against grounded metal waste pail. Trigger gun at least 1 minute until paint appears.

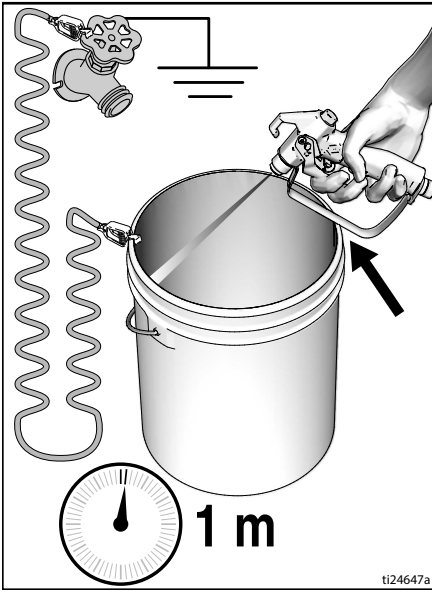

8. Move gun to paint pail and trigger for 20 seconds. Release trigger and allow sprayer to build pressure. Engage trigger lock.

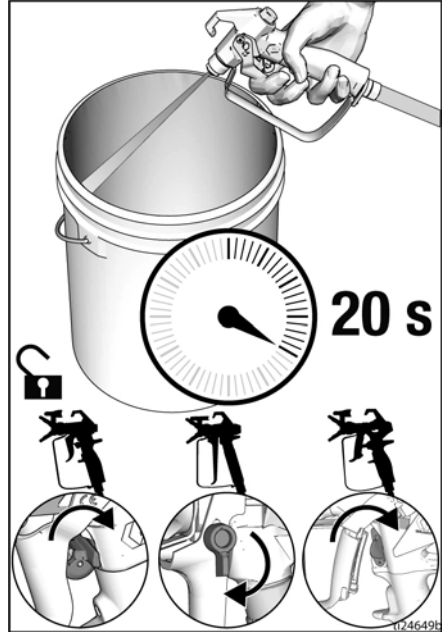

9. Inspect Airless Hose and hose connections for leaks. If leaks occur, perform **Pressure Relief Procedure**, page 12, then tighten all fittings and repeat **Startup** procedure. If there are no leaks, continue with **Operation**, page 19.

High-pressure spray is able to inject toxins into the body and cause serious bodily injury. Do not stop leaks with hand or rag.				

Operation

Spray Tip Installation



To avoid serious injury from skin injection, do not put your hand in front of the Spray Tip when installing or removing the Spray Tip and Spray Tip Guard.

1. Perform **Pressure Relief Procedure**, page 12.
2. Use spray tip (A) to insert OneSeal™ (B) into tip guard (C).

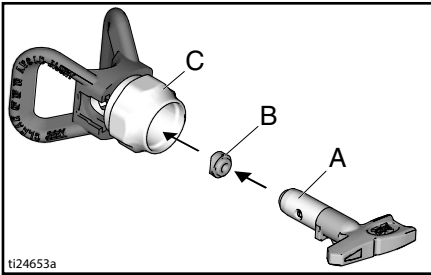

2. Insert Spray Tip.

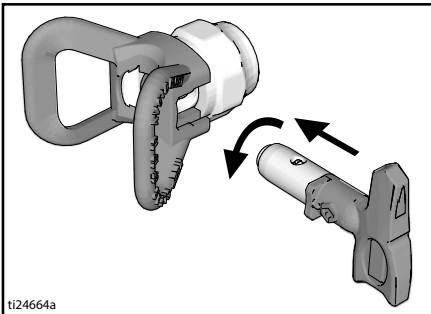

3. Screw assembly onto gun. Tighten.

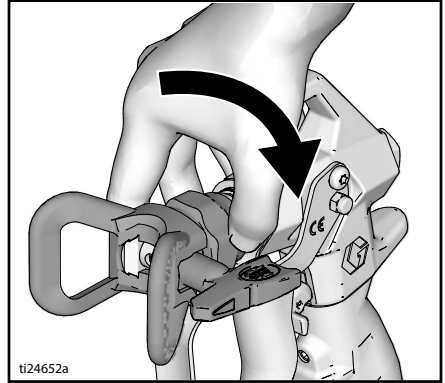

Spray

When a RAC X™ FF LP Fine Finish Low Pressure reversible spray tip is used, spraying pressure can be lowered. Spraying at a lower pressure results in less overspray and reduces spray tip wear. Adjust the sprayer pressure to minimize overspray.

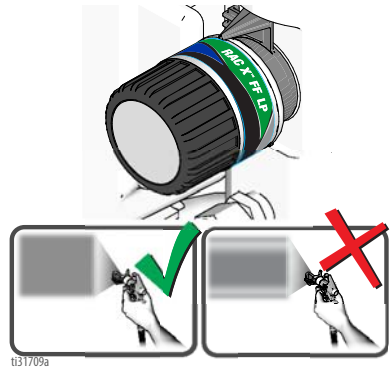

Atomized, evenly distributed fan pattern

Tails

Operation

1. Spray test pattern. Adjust pressure to eliminate heavy edges.

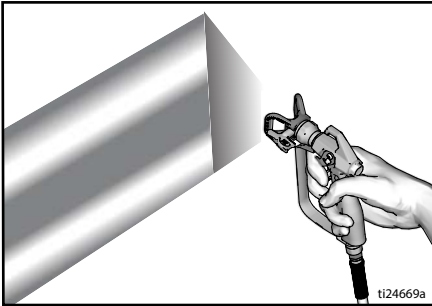

2. Use smaller tip size if pressure adjustment cannot eliminate heavy edges.
3. Hold gun perpendicular, 10-12 in. (25-30 cm) from surface. Spray back and forth; overlap by 50%.

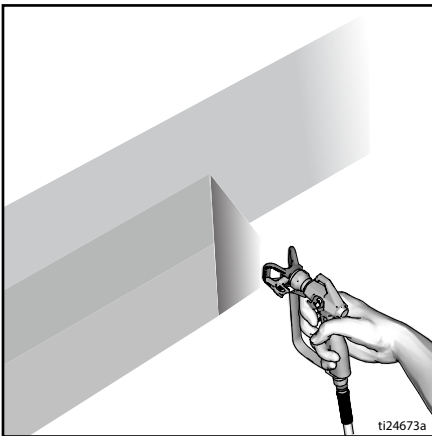

4. Trigger gun after moving. Release trigger before stopping. For additional spraying information, see separate gun manual.

Clear Tip Clog



To avoid injury, never point gun at your hand or into a rag!

1. Release trigger. Engage trigger lock. Rotate Spray Tip. Disengage trigger lock. Trigger gun at waste area to clear clog.

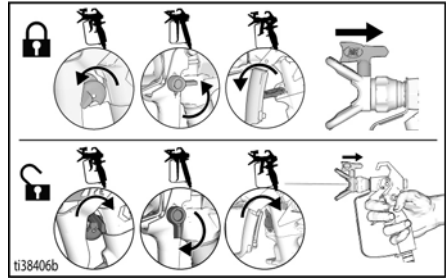

2. Engage trigger lock. Return Spray Tip to original position. Disengage trigger lock and continue spraying.

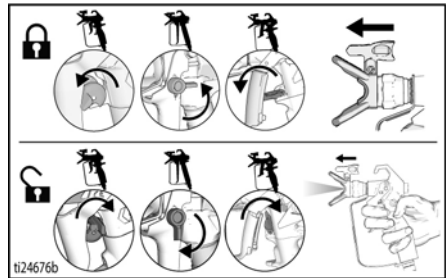

Cleanup

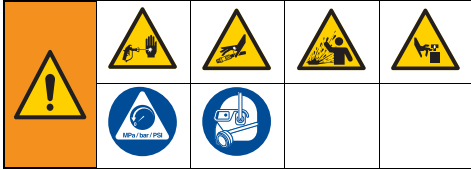

1. Perform **Pressure Relief Procedure**, page 12.
2. Remove tip guard and Spray Tip. For additional information, see separate gun manual.

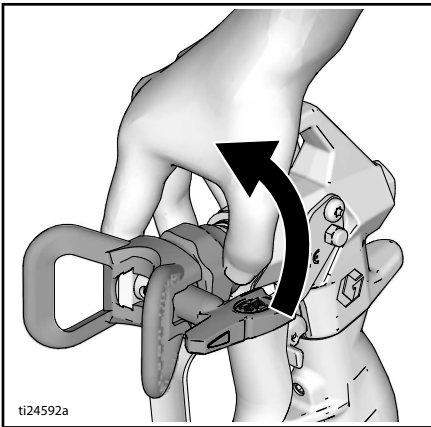

3. Remove fluid intake and drain tube from paint, wipe excess paint off outside.

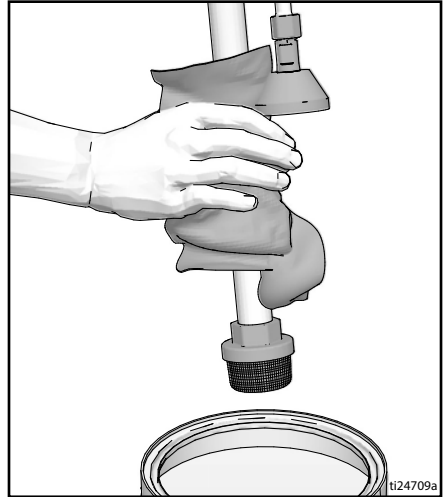

4. Place fluid intake in flushing fluid. Use water for water-based paint and mineral spirits for oil-based paint. Place drain tube in waste pail.

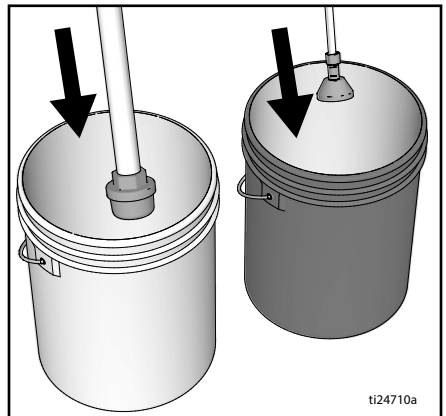

5. Turn prime valve horizontal.

Operation

6. Increase pressure 1/2 turn to start motor. Hold gun against paint pail. Disengage trigger lock. Trigger gun and increase pressure until the pump runs steady and flushing fluid appears.

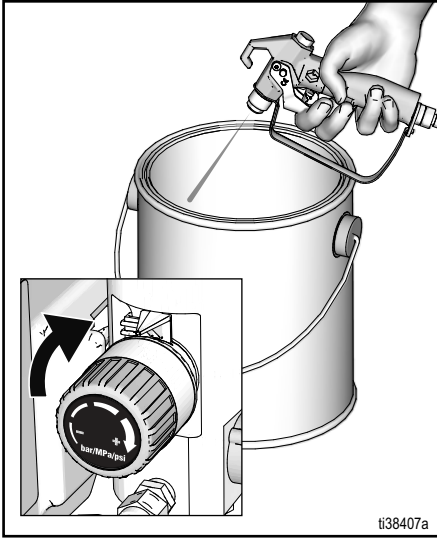

8. While continuing to trigger gun, turn prime valve down. Then, release gun trigger. Allow flushing fluid to circulate until fluid comes out of drain tube clear.

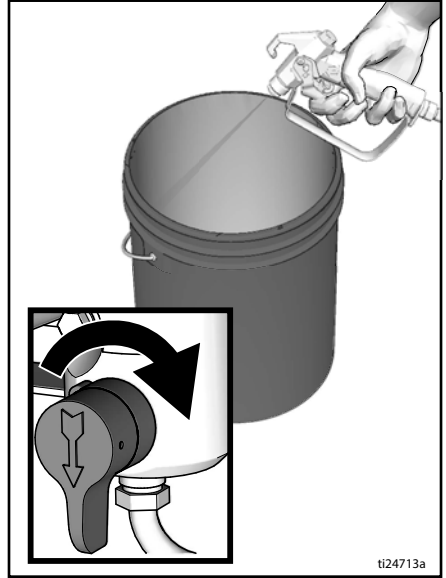

7. Stop triggering gun. Move gun to waste pail, hold gun against pail, trigger gun to thoroughly flush system.

9. Raise fluid intake above flushing fluid.

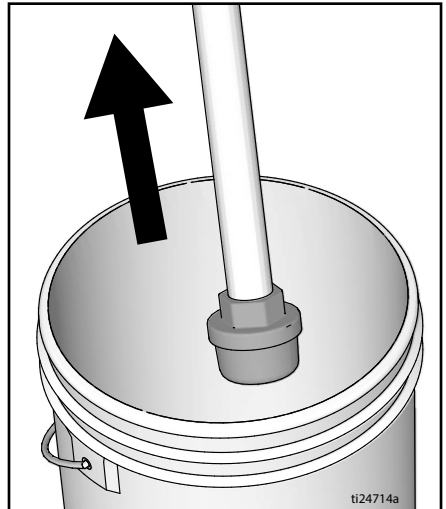

10. Turn prime valve horizontal. Trigger gun into flushing pail for 20 seconds to purge fluid from hose.

11. Engage trigger lock.

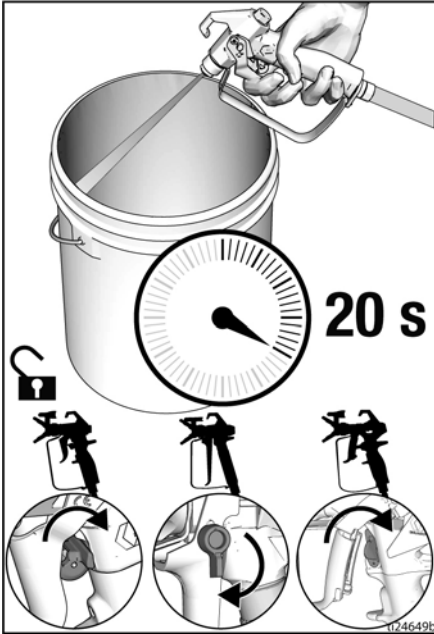

12. Turn pressure control knob to the lowest pressure setting and turn ON/OFF switch to OFF position. Disconnect power to sprayer.

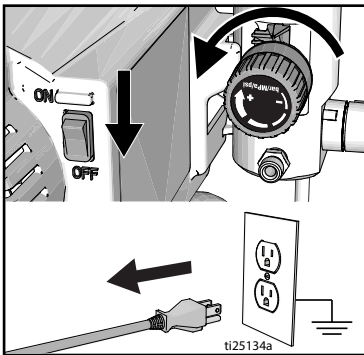

13. Remove filter from gun and sprayer if installed. Clean and inspect. Install filter. See separate gun manual.

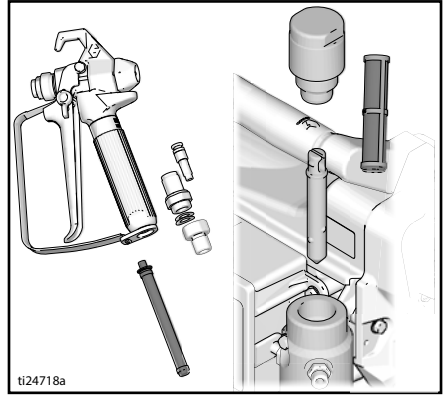

14. If flushing with water, flush again with mineral spirits or Pump Armor to leave a protective coating to prevent freezing or corrosion.

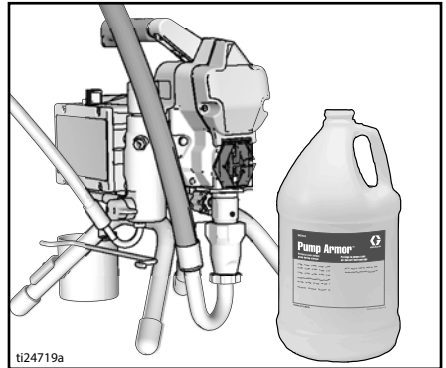

15. Wipe sprayer, hose and gun with a rag soaked in water or mineral spirits.

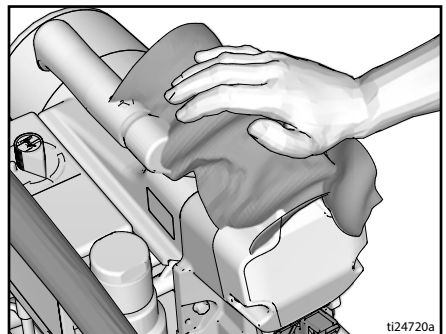

Maintenance

Routine maintenance is important to ensure proper operation of your sprayer. Maintenance includes performing routine actions which keep your sprayer in operation and prevents trouble in the future.



Activity	Interval
Inspect/clean sprayer filter, fluid inlet strainer, and gun filter.	Daily or each time you spray
Inspect motor shield vents for blockage.	Daily or each time you spray
Fill TSL by adding through TSL fill point.	Daily or each time you spray
Inspect motor brushes for wear. Brushes must be 1/2 in. (13mm) minimum length. NOTE: Brushes do not wear at the same rate on both sides of motor. Check both brushes.	Every 1000 gallons (3785 liters)
Check sprayer stall. With sprayer gun NOT triggered, sprayer motor should stall and not restart until gun is triggered again. If sprayer starts again with gun NOT triggered, inspect pump for internal/external leaks and check prime valve for leaks.	Every 1000 gallons (3785 liters)
Throat packing adjustment When pump packing begins to leak after extended use, tighten packing nut down until leakage stops or lessens. This allows approximately 100 gallons of additional operation before a repacking is required. Packing nut can be tightened without O-ring removal.	As necessary based on usage

Troubleshooting

Mechanical/Fluid Flow



1. Follow **Pressure Relief Procedure**, page 12, before checking or repairing.
2. Check all possible problems and causes before disassembling the unit.

Problem	What to Check If check is OK, go to next check	What to Do When check is not OK, refer to this column
Pump output is low	Spray tip worn.	Follow Pressure Relief Procedure , page 12, then replace tip. See separate gun or tip manual.
	Spray tip clogged.	Relieve pressure. Check and clean spray tip.
	Paint supply.	Refill and reprime pump.
	Intake strainer clogged.	Remove and clean, then reinstall.
	Intake valve ball and piston ball are not seating properly.	Remove intake valve and clean. Check balls and seats for nicks; replace if necessary. See pump manual. Strain paint before using to remove particles that could clog pump.
	Fluid filter or tip filter is clogged or dirty.	Clean filter.
	Prime valve leaking.	Follow Pressure Relief Procedure , page 12, then repair prime valve.
	Verify pump does not continue to stroke when gun trigger is released. (Prime valve not leaking.)	Service pump. See pump manual.
	Leaking around throat packing nut which may indicate worn or damaged packings.	Replace packings. See pump manual. Also check piston valve seat for hardened paint or nicks and replace if necessary. Tighten packing nut/wet-cup.

Troubleshooting

Problem	What to Check If check is OK, go to next check	What to Do When check is not OK, refer to this column
Pump output is low	Pump rod damage.	Repair pump. See pump manual.
	Low stall pressure.	Turn pressure knob fully clockwise. Make sure pressure control knob is properly installed to allow full clockwise position. If problem persists, replace pressure control.
	Piston packings are worn or damaged.	Replace packings. See pump manual.
	O-ring in pump is worn or damaged.	Replace o-ring. See pump manual.
	Intake valve ball is packed with material.	Clean intake valve. See pump manual.
	Large pressure drop in hose with heavy materials.	Reduce overall length of hose.
	Check extension cord for correct size.	See Extension Cords , page 11.
	Loose motor brushes and terminals.	Tighten terminal screws. Replace brushes if leads are damaged.
	Worn motor brushes. (Brushes must be 1/2 in. [13mm] minimum length).	Replace brushes.
	Broken and misaligned motor brush springs. Rolled portion of spring must rest squarely on top of brush.	Replace spring if broken. Realign spring with brush.
	Motor brushes are binding in brush holders.	Clean brush holders, remove carbon dust with a small cleaning brush. Align brush lead with slot in brush holder to assure free vertical brush movement.
Motor runs but pump does not stroke	Connecting rod assembly damaged. See pump manual.	Replace connecting rod assembly. See pump manual.
	Gears or drive housing damaged.	Inspect drive housing assembly and gears for damage and replace if necessary.
Excessive paint leakage into throat packing nut	Throat packing nut is loose.	Remove throat packing nut spacer. Tighten throat packing nut just enough to stop leakage.
	Throat packings are worn or damaged.	Replace packings. See pump manual.
	Displacement rod is worn or damaged.	Replace rod. See pump manual.

Problem	What to Check If check is OK, go to next check	What to Do When check is not OK, refer to this column
Fluid is spitting from gun	Air in pump or hose.	Check and tighten all fluid connections. Cycle pump as slowly as possible during priming.
	Spray tip is partially clogged.	Clear tip. See Clear Tip Clog , page 20.
	Fluid supply is low or empty.	Refill fluid supply. Prime pump. See pump manual. Check fluid supply often to prevent running pump dry.
Pump is difficult to prime	Air in pump or hose.	Check and tighten all fluid connections. Cycle pump as slowly as possible during priming.
	Intake valve is leaking.	Clean intake valve. Be sure ball seat is not nicked or worn and that ball seats well. Reassemble valve.
	Pump packings are worn.	Replace pump packings. See pump manual.
	Paint is too thick.	Thin the paint according to supplier recommendations.
Sprayer operates for 5 to 10 minutes then stops	Pump packing nut too tight. When pump packing nut is too tight the packings on the pump rod restrict pump action and overloads the motor.	Loosen pump packing nut. Check for leaks around throat. If necessary, replace pump packings. See Pump manual.

Troubleshooting

Electrical

Symptom: Sprayer does not run, stops running, or will not shut off.



2. Turn the ON/OFF switch **OFF**, wait 30 seconds and then turn power back **ON** again (this ensures sprayer is in normal run mode).
3. Turn pressure control knob clockwise 1/2 turn.

Perform **Pressure Relief Procedure**, page 12.

1. Plug sprayer into correct voltage, grounded outlet.

To avoid electrical shock hazards when covers are removed for troubleshooting, wait 7 seconds after disconnecting power cord for stored electricity to dissipate.				

Problem	What to Check	How to check
Sprayer does not run at all.	Check electrical supply.	Make certain that there is AC voltage. 100-130V for 110-120VAC models or 210-255V for 230VAC models.
	Check pressure control connections.	Make certain connector is clean and firmly connected.
	Check pressure control.	Connect known good pressure control. If the motor runs, replace pressure control.
	Check replaceable fuse.	With sprayer unplugged (no power applied), make certain there is continuity through the fuse.
	Check motor leads.	Make certain terminals are clean and firmly connected.

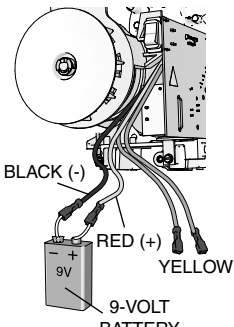
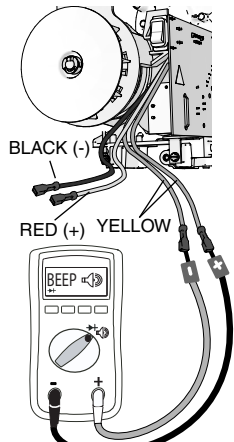

Problem	What to Check	How to check
	<p>Check motor rotation.</p>	<p>Perform a spin test by connecting a 9 –12 Volt battery to the motor leads. Motor leads may vary in style and size. Locate the two wires going to the carbon brushes normally Red and Black. Motor should spin when battery is connected to the motor leads.</p>  <p>ti25122a</p>
	<p>Check motor thermal switch.</p>	<p>Motor should be at ambient temperature for this test. Connect the yellow leads from the motor to an Ohm meter. Meter should indicate continuity.</p>  <p>ti25123a</p>

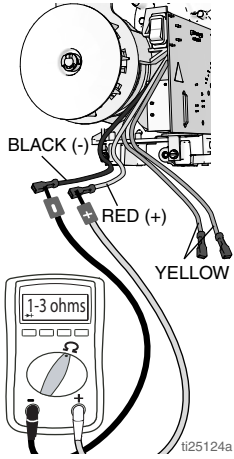
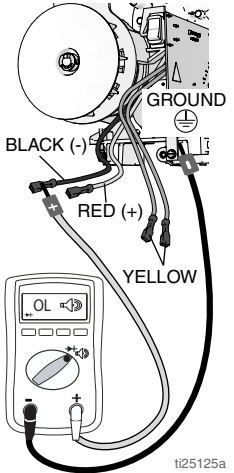
Troubleshooting



Problem	What to Check	How to check
	Check motor armature resistance.	<p>Connect the Red and Black leads from the motor to an Ohm meter. Rotate the motor while checking for opens. If an open is found replace the motor.</p>  <p>ti25124a</p>
	Check for motor short.	<p>Use an Ohm meter to check motor for shorts. Connect (-) meter lead to motor case. Move the (+) meter lead to each motor wire. Meter should read open on all wires.</p>  <p>ti25125a</p>

Problem	What to Check	How to check
Sprayer will not shut off after reaching or exceeding maximum pressure.	Check pressure control.	Disconnect pressure control, if sprayer still runs, replace control board. If the sprayer stops, replace pressure control.
Basic electrical problems	Motor leads are securely fastened and properly mated	Replace loose terminals; crimp to leads. Be sure terminal are firmly connected. Clean circuit board terminals. Securely reconnect leads.
	For loose motor brush lead connections and terminals.	Tighten terminal screws. Replace brushes if leads are damaged.
	Brushes must be 1/2 in. [13mm] minimum. NOTE: Brushes do not wear at the same rate on both sides of motor. Check both brushes.	Replace brushes.
	Broken or misaligned motor brush springs. Rolled portion of spring must rest squarely on top of brush.	Replace spring if broken. Realign spring with brush.
	Motor brushes may be binding in brush holders.	Clean brush holders. Remove carbon with small cleaning brush. Align brush leads with slot in brush holder to assure free vertical brush movement.
	Motor armature commutator for burn spots, gouges or extreme roughness.	Remove motor and have motor shop resurface commutator if possible.

Sprayers Parts

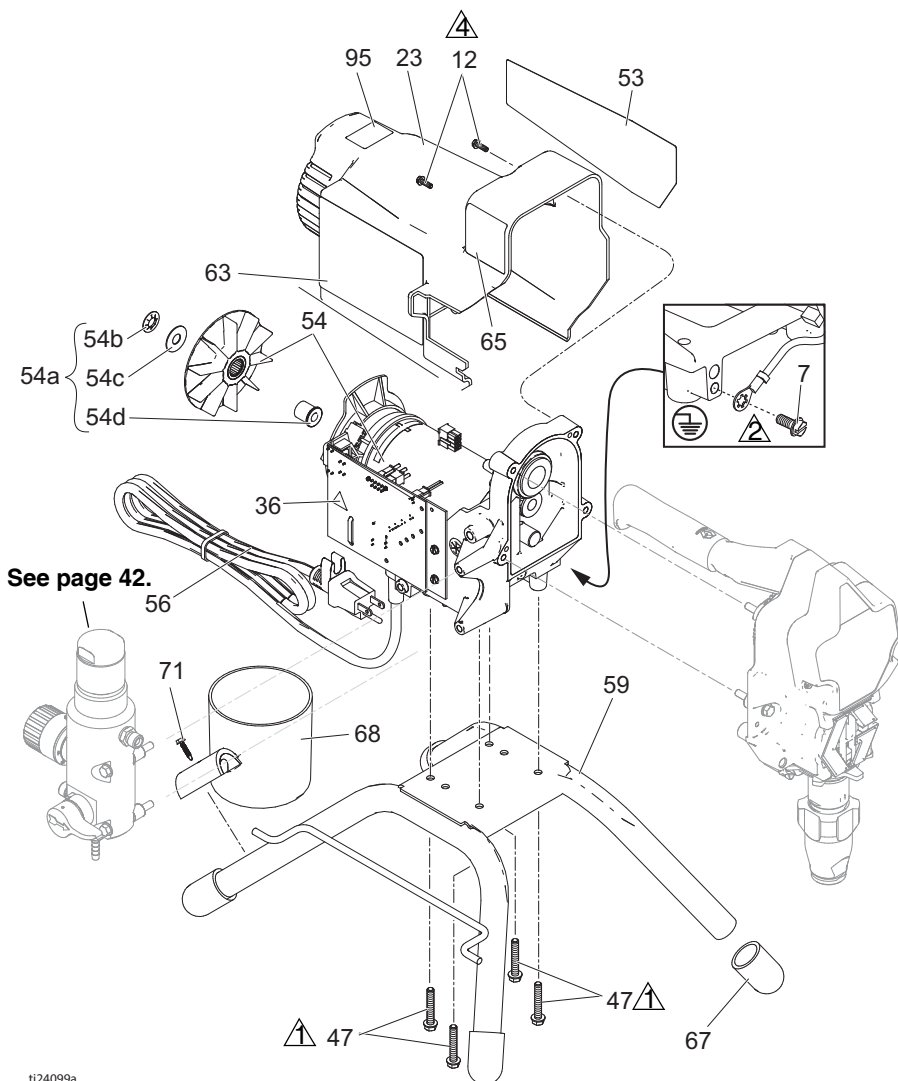
Ref.	Torque
	140-160 in-lb (15.8 - 18.1 N•m)
	30-35 in-lb (3.4 - 4.0 N•m)
	23-27 in-lb (2.6 - 3.1 N•m)



Ref.	Torque
	140-160 in-lb (15.8 - 18.1 N•m)
	Hammer tight
	23-27 in-lb (2.6 - 3.1 N•m)

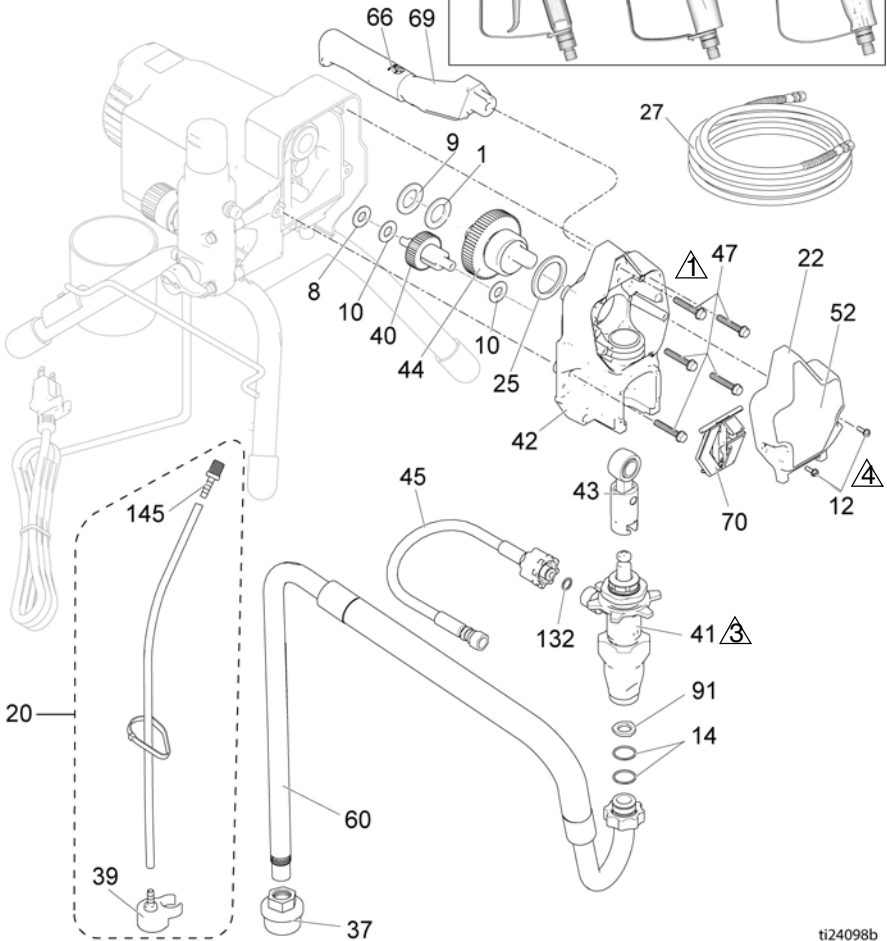
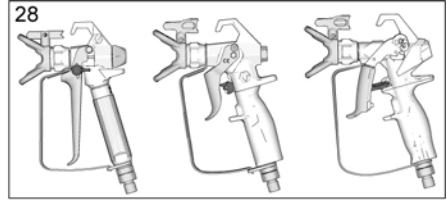



ti24098b

Sprayers Parts

190, 290, 390 Stand Sprayers Parts List

Ref.	Part	Description	Qty.	Ref.	Part	Description	Qty.
1	107434	BEARING, thrust	1		17C489	Europe	
7	115498	SCREW, mch, slot/hex, wash hd	1	42	24W817	HOUSING, drive <i>includes 47</i>	1
8	116073	WASHER, thrust	1	43	24W640	ROD, connecting	1
9	116074	WASHER, thrust	1	44	24X020	GEAR, crankshaft <i>includes 25</i>	1
10	116079	BEARING, thrust	2	45	24W830	KIT, hose, cpld <i>includes 132</i>	1
12	117501	SCREW, mach, slot hex wash hd	4	47	117493	SCREW, mach, hex washer hd	9
14	117559	O-RING	2	52	See page 41	LABEL, front	1
20	249051	KIT, tube, drain <i>includes 39, 145</i>	1	53	See page 41	LABEL, side	1
22		COVER, front	1	54 *		KIT, motor, electric <i>includes 54a</i>	1
	17C540	Stand models 17C341, 17C438, 17C344, 18C268, 17C384, 17D899, 17D901, 17D900			17C794	110/120V	
	17C539	Stand models 17C310, 17C346, 17C347, 17C348, 17C385, 17C386, 17C389, 826195			17C799	230V	
23		SHIELD, motor	1	54a	17C795	FAN, motor, roller, clutch <i>includes 54b, 54c, 54d</i>	1
	15E341	Stand models 17C341, 17C438, 17C344, 18C268, 17C384, 17D899, 17D901, 17D900		54b		NUT, push	1
	15J371	Stand models 17C310, 17C346, 17C347, 17C348, 17C385, 17C386, 17C389, 826195		54c		WASHER, shim, round	1
25	180131	BEARING, thrust	1	54d		ADAPTER, shaft	1
27	See page 41	HOSE, cpld, 1/4 in. x 25 or 50 ft	1	56	See page 42	CORD, power	1
28	See page 41	GUN, spray	1	59	15E823	FRAME, stand mount	1
34	See page 41	CARD, medical alert (not shown)	1	60	246386	HOSE, suction set <i>includes 14, 37, 91</i>	1
▲	189930	LABEL, caution	1	63	See page 41	LABEL, warning	1
▲	246385	STRAINER, 7/8-14 unf	1	65	See page 41	LABEL, warning icons intl	1
39	244035	DEFLECTOR, barbed	1	66	116139	GRIP, handle	1
40	249194	GEAR, reducer	1	67	15G857	CAP, leg	4
41		PUMP, displacement	1	68	287903	CUP, suction/drain	1
	17C487	North America		69	287072	HANDLE <i>includes 47, 66</i>	1
	17C488	Asia/ANZ/Japan		70	17C483	COVER, pump rod	1
				71	122667	SCREW, drill, hex washer head	1
				91	115099	WASHER	1
				132	16H137	PACKING, O-RING	1
				206994	FLUID, TSL, 8 oz (not shown)		1
				145	M70809	FITTING, barbed, hose	1
				* For motor brush kit order 249042			
				▲ Replacement safety labels, tags, and cards are available at no cost.			

390 Lo-Boy Sprayer Parts

Ref.	Torque
	140-160 in-lb (15.8 - 18.1 N•m)
	30-35 in-lb (3.4 - 4.0 N•m)
	23-27 in-lb (2.6 - 3.1 N•m)

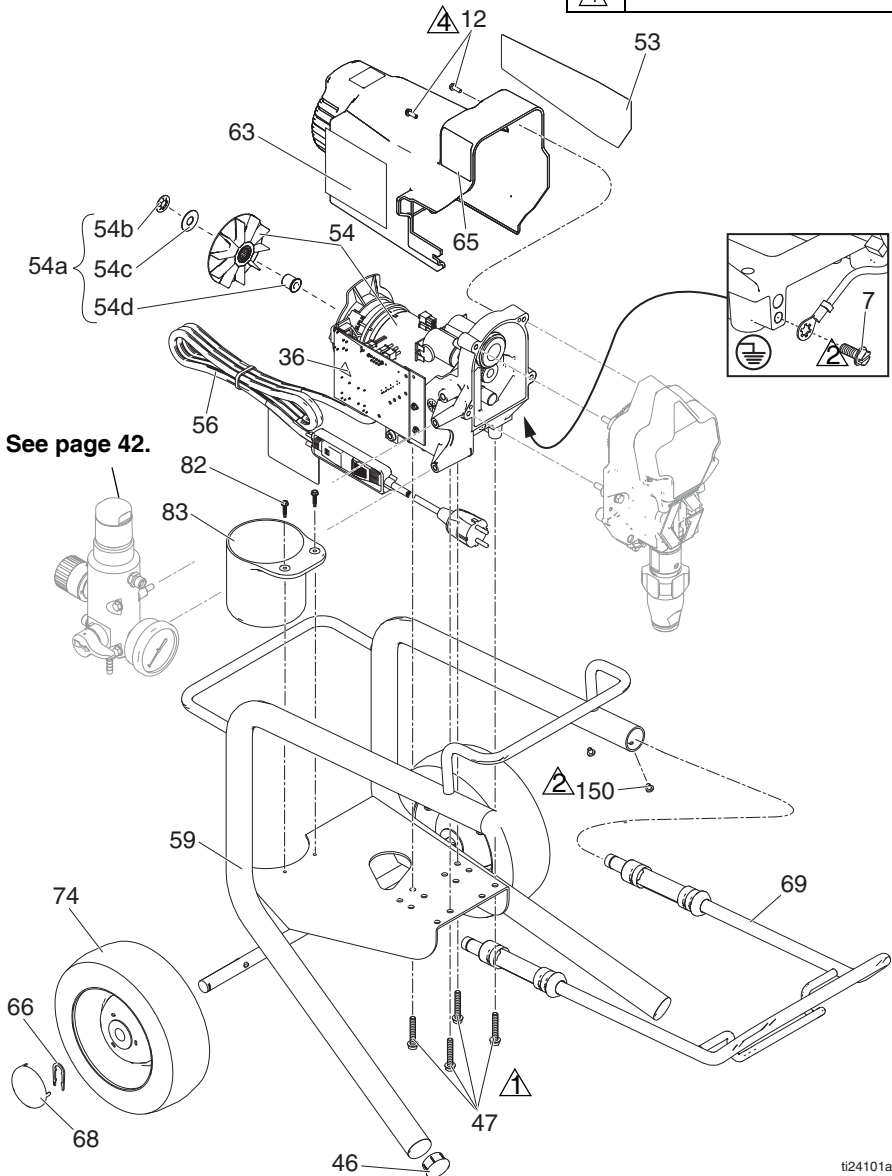

390 Lo-Boy Sprayer Parts

Ref.	Torque
▲1	140-160 in-lb (15.8 - 18.1 N•m)
▲3	Hammer tight
▲4	23-27 in-lb (2.6 - 3.1 N•m)

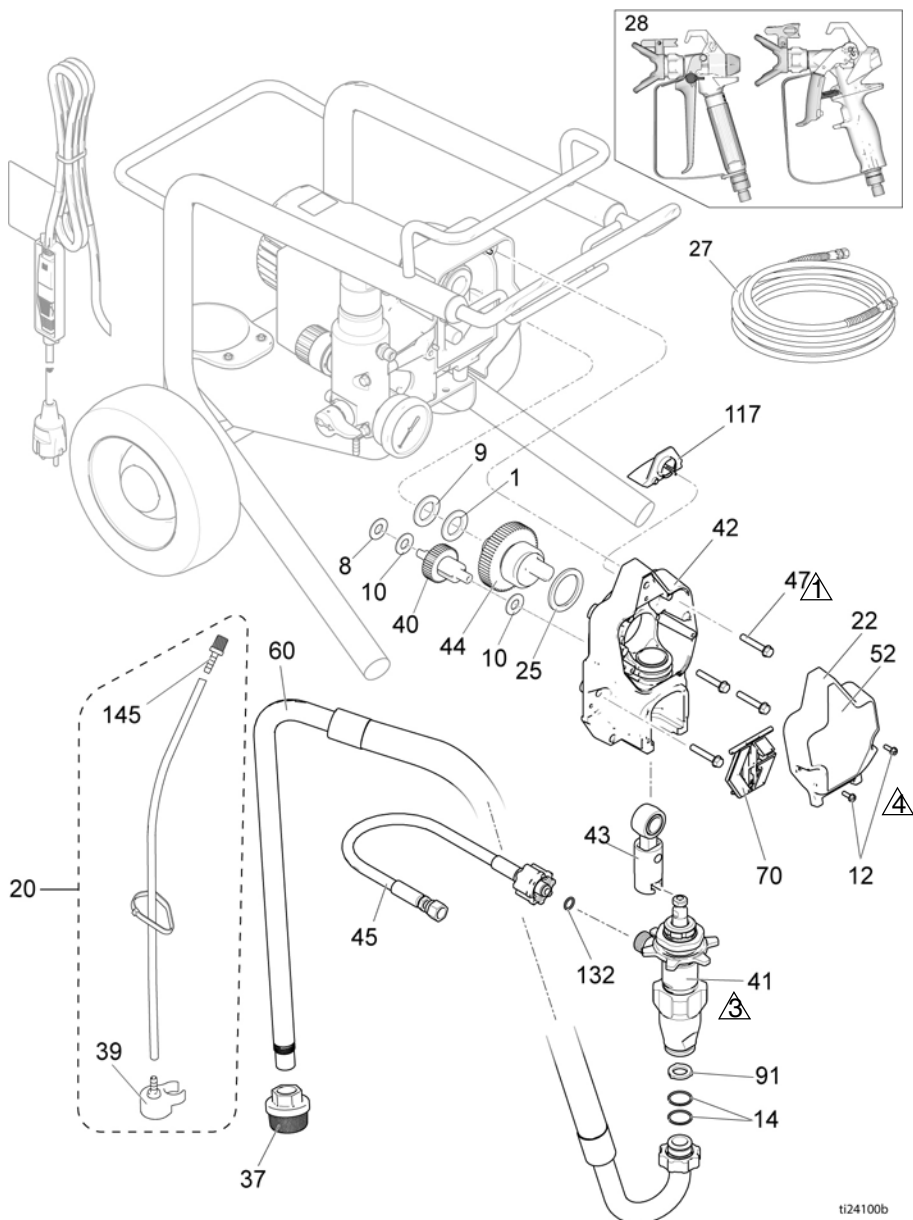

ti24100b

334567P

390 Lo-Boy Sprayer Parts

390 Lo-Boy Sprayer Parts List



Ref.	Part	Description	Qty.	Ref.	Part	Description	Qty.
1	107434	BEARING, thrust	1	54a	17C795	FAN, motor, roller, clutch <i>includes 54b, 54c, 54d</i>	1
7	115498	SCREW, mch, slot/hex, wash hd	1	54b		NUT, push	1
8	116073	WASHER, thrust	1	54c		WASHER, shim, round	1
9	116074	WASHER, thrust	1	54d		ADAPTER, shaft	1
10	116079	BEARING, thrust	2	56	See page 42	CORD, power	1
12	117501	SCREW, mach, slot hex wash hd	4	59	246250	FRAME, cart, lo	1
14	117559	O-RING	2	60	246386	HOSE, suction set <i>includes 14, 37, 91</i>	1
20	249051	KIT, tube, drain <i>includes 39, 145</i>	1	63	15H087	LABEL, warning	1
22	17C539	COVER, front	1	▲			
23	15J371	SHIELD, motor	1	65	189930	LABEL, warning icons intl	1
25	180131	BEARING, thrust	1	▲			
27	240794	HOSE, cpld, 1/4 in. x 50 ft	1	66	15B999	CLIP, retaining	2
28	288427	GUN, spray	1	68	104811	CAP, hub	2
34	17A134	CARD, medical alert (not shown)	1	69	287488	HANDLE	1
▲				70	17C483	COVER, pump rod	1
37	246385	STRAINER, 7/8-14 unf	1	74	195766	WHEEL, semi-pneumatic	2
39	244035	DEFLECTOR, barbed	1	82	122667	SCREW, drill, hex washer hd	2
40	249194	GEAR, reducer	1	83	15B870	CUP, suction/drain	1
41	17C489	PUMP, displacement	1	91	115099	WASHER	1
42	24W817	HOUSING, drive <i>includes 47</i>	1	117	15G447	PLUG, shield, painted	1
43	24W640	ROD, connecting	1	132	16H137	PACKING, O-RING	1
44	24X020	GEAR, crankshaft <i>includes 25</i>	1	145	M70809	FITTING, barbed, hose	1
45	24W830	KIT, hose, cpld <i>includes 132</i>	1	150	109032	SCREW, mach, pnh	4
46	107310	PLUG, tubing	2	206994	FLUID, TSL, 8 oz (not shown)	1	
47	117493	SCREW, mach, hex washer hd	8				
52	17C819	LABEL, front	1				
53	17C820	LABEL, side	1				
54 *	17C799	KIT, motor, electric, 230V <i>includes 54a</i>	1				

* For motor brush kit order 249042

▲ Replacement safety labels, tags, and cards are available at no cost.

190, 290, 390 Hi-Boy Sprayers Parts

190, 290, 390 Hi-Boy Sprayers Parts

Ref.	Torque
	140-160 in-lb (15.8 - 18.1 N•m)
	30-35 in-lb (3.4 - 4.0 N•m)
	23-27 in-lb (2.6 - 3.1 N•m)

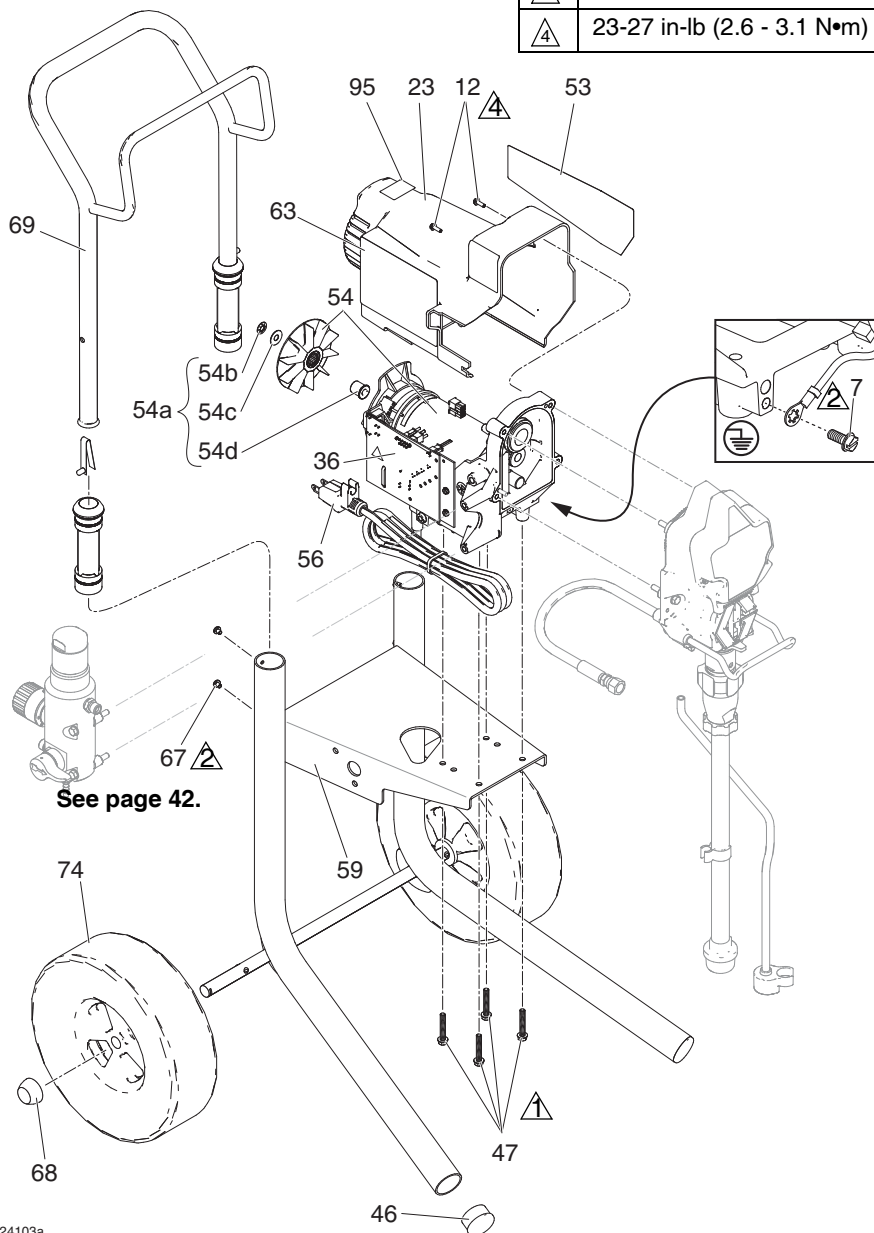

190, 290, 390 Hi-Boy Sprayers Parts

Ref.	Torque
	140-160 in-lb (15.8 - 18.1 N•m)
	Hammer tight
	23-27 in-lb (2.6 - 3.1 N•m)

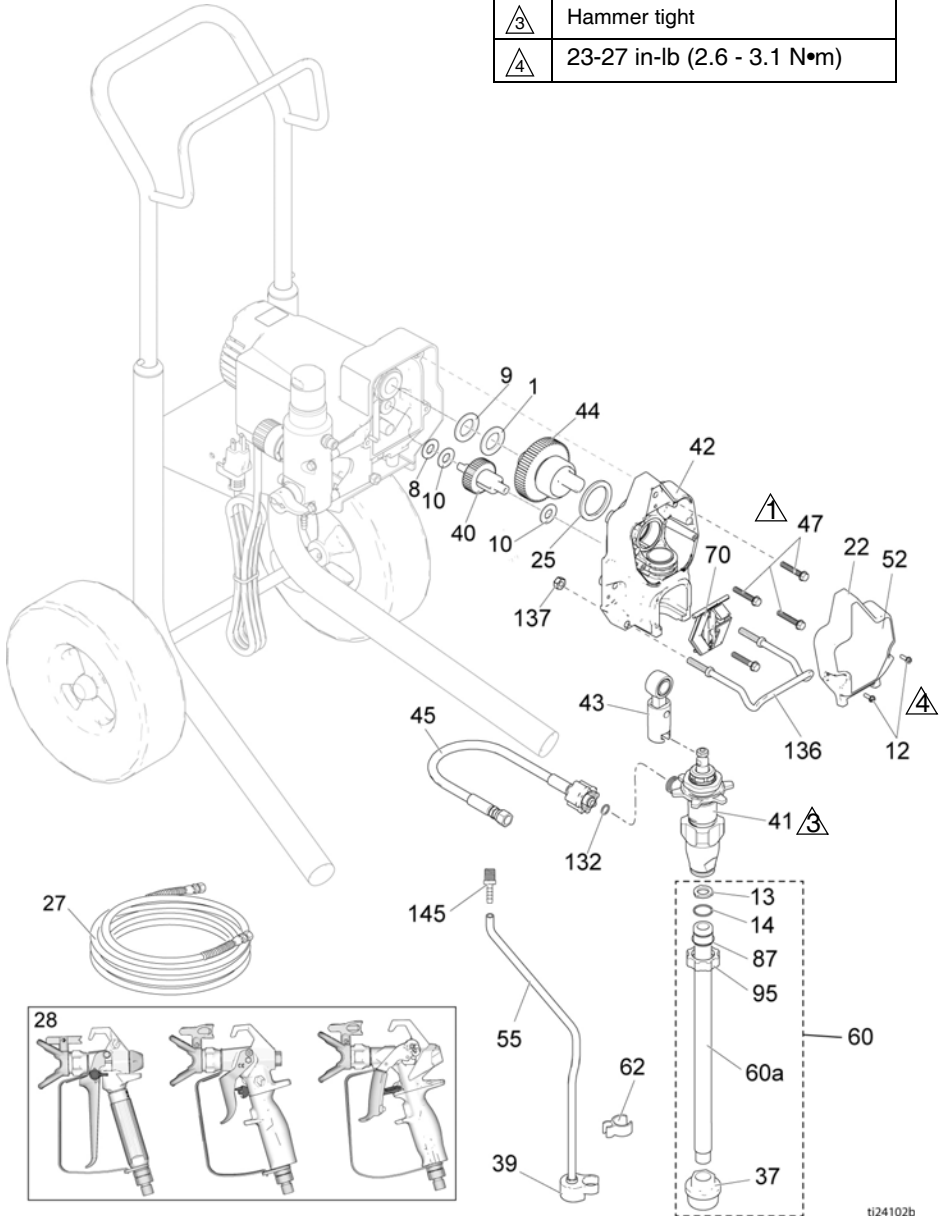

ti24102b

190, 290, 390 Hi-Boy Sprayers Parts

190, 290, 390 Hi-Boy Sprayers Parts List





Ref. Part	Description	Qty.	Ref. Part	Description	Qty.
1	107434 BEARING, thrust	1	47	117493 SCREW, mach, hex washer hd	8
7	115498 SCREW, mch, slot/hex, wash hd	1	52	See page LABEL, front	1
8	116073 WASHER, thrust	1	41		
9	116074 WASHER, thrust	1	53	See page LABEL, side	1
10	116079 BEARING, thrust	2	41		
12	117501 SCREW, mach, slot hex wash hd	4	54 *	KIT, motor, electric <i>includes 54a</i>	1
13	115099 WASHER	1	17C794	110/120V	
14	103413 PACKING, O-ring	1	17C799	230V	
22	COVER, front	1	54a	17C795 FAN, motor, roller, clutch <i>includes 54b, 54c, 54d</i>	1
	17C540 Hi-Boy models 17C342, 17C343		54b	NUT, push	1
	17C539 Hi-Boy models 17C313, 17C349, 17C350, 17C351, 17C388		54c	WASHER, shim, round	1
			54d	ADAPTER, shaft	1
23	SHIELD, motor	1	55	15K092 TUBE, drain	1
	15E341 Hi-Boy models 17C342, 17C343		56	See page CORD, power	1
	15J371 Hi-Boy models 17C313, 17C349, 17C350, 17C351, 17C388		59	17C485 FRAME, cart universal	1
25	180131 BEARING, thrust	1	60	25C786 KIT, suction, intake <i>includes 13, 14, 37, 60a, 87, 95</i>	1
27	See page HOSE, cpld, 1/4 in. x 25 or 50 ft	1	60a	17C949 TUBE, suction, intake	1
28	See page GUN, spray	1	62	195400 CLIP, spring	1
	41		63	See page LABEL, warnings	1
34	See page CARD, medical alert (not shown)	1	▲ 41		
▲ 36	189930 LABEL, caution	1	65	See page LABEL, warning	1
▲ 37	235004 STRAINER, 7/8-14 unf	1	▲ 41		
39	244035 DEFLECTOR, barbed	1	67	109032 SCREW, mach, pnh	4
40	249194 GEAR, reducer	1	68	119452 CAP, hub	2
41	PUMP, displacement	1	69	287489 HANDLE assy, hi cart	1
	17C487 North America		70	17C483 COVER, pump rod	1
	17C488 Asia/ANZ/Japan		74	119451 WHEEL, semi-pneumatic	2
	17C489 Europe		87	15B652 WASHER, suction	1
42	24W817 HOUSING, drive <i>includes 47</i>	1	95	15E813 NUT, jam	1
43	24W640 ROD, connecting	1	132	16H137 PACKING, O-ring	1
44	24X020 GEAR, crankshaft <i>includes 25</i>	1	136	17C990 HANGER, pail	1
45	24W830 KIT, hose, cpld <i>includes 132</i>	1	137	111040 NUT, lock, insert	2
46	108691 PLUG, tubing	2	145	M70809 FITTING, barbed, hose	1
			206994	FLUID, TSL, 8 oz (not shown)	1
			* For motor brush kit order 249042		
			▲ Replacement safety labels, tags, and cards are available at no cost.		

Accessories and Labels

Sprayer Model (Series)	Ref. 27 Hose, 1/4 in. x ❖ ♦ ft	Ref. 28 Gun, Spray	Ref. 52 Label, Front	Ref. 53 Label, Side	Ref. 65 Label, Warning ▲	Ref. 34 Card, Medical Alert ▲	Ref. 63 Label, Danger ▲
17C310 17C313	240794 ♦	288430	17E998	17E999	195793 &	222385 #	15K359 #
17C341 17C342 17C438	240793 ❖	289843	17C860	17C861	---	222385 #	16G596 \$
17C343 17C344 18C268	240794 ♦	288438	17C862	17C863	---	222385 #	16G596 \$
17C346 17C347 17C348 17C349 17C350 17C351	240794 ♦	288438	17C853	17C854	---	222385 #	16G596 \$
17C384	240794 ❖	288427	17D764	17D765	195792 %	17A134 %	15H087 @
17C385	240794 ♦	17Y044	17C819	17C820	195792 %	17A134 %	15H086 ❄
17C386 17C387 17C388	240794 ♦	17Y044	17C819	17C820	195792 %	17A134 %	15H087 @
17C389	247340 ♦	17J910	17C853	17C854	195792 %	17A134 %	15H087 @
17D899	247339 ❖	246506	17D764	17D765	195793 &	222385 #	15K359 #
17D900	247339 ❖	246506	17D764	17D765	17C136 *	222385 #	17C135 *
17D901	247339 ❖	246506	17D764	17D765	---	222385 #	16G596 \$
826195 (A)	826079 ♦	826086	17C821	17C822	195793 &	222385 #	15K359 #
826195 (B)	826079 ♦	826256	17E938	17E939	195793 &	222385 #	15K359 #
288526 – Kit, accessory, hopper							
# – English, Spanish, French			@ – Asia/ANZ		* – English, Spanish, Portuguese		
% – English, Chinese, Korean			\$ – Europe				
& – North America			❄ – Japan				
❖ – 25 ft. (7.6m)							
♦ – 50 ft. (15.2m)							
▲ Replacement safety labels, tags, and cards are available at no cost.							

Control Box and Filter

Control Box and Filter

Ref.	Torque
 140-160 in-lb (15.8 - 18.1 N•m)	
 30-35 in-lb (3.4 - 4.0 N•m)	
 130-150 in-lb (14.7 - 16.9 N•m)	
 48-72 in-lb (5.4 - 8.1 N•m)	

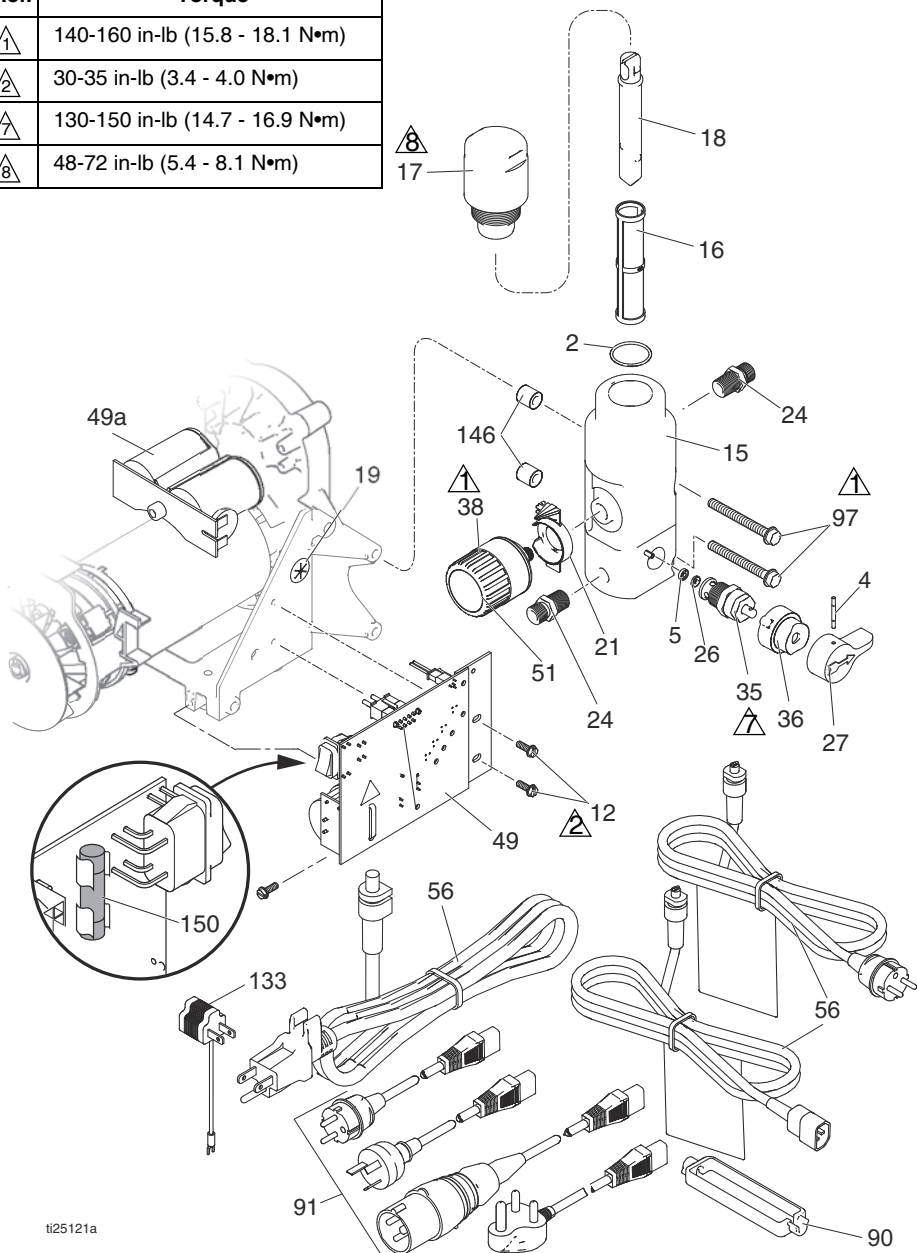

ti25121a

Control and Filter Parts List

Ref.	Part	Description	Qty.	Ref.	Part	Description	Qty.
2	117828	PACKING, o-ring	1	27	187625	HANDLE, valve, drain	1
4	111600	PIN, grooved	1	35	239914	VALVE, drain, <i>includes</i>	1
5	277364	GASKET, seat, valve	1			5, 26	
12	117501	SCREW, mach, hex washer hd	3	36	224807	BASE, valve	1
15	See page 44	MANIFOLD, fluid	1	38	See page 44	KIT, control, pressure, <i>includes 19, 20, 51</i>	1
16*		FILTER, fluid	1	49		BOARD, control	1
		Tall manifold			249052	120V	
	246425	30 mesh (gray)			16X295	230V <i>includes 49a</i>	
	246384	60 mesh, original (black)		49a	24R905	BOARD, capacitor, 230V	1
	246382	100 mesh (blue)		51	15A464	LABEL, control	1
	246383	200 mesh (red)		56	See page 44	CORD, power	1
		Short manifold		90	195551	RETAINER, plug, adapter (on select models)	1
	243080	60 mesh, original		91	See page 44	CORD SET, adapter	1
	243081	100 mesh		97	See page 44	SCREW, mach, HWH	2
	243226	200 mesh (red)		133	244285	ADAPTER, Japan	1
17*		CAP, manifold	1	145	M70809	FITTING, barbed	1
	287902	KIT, cap, tall manifold, <i>includes 18</i>		146	17D294	SPACER, manifold	2
	243102	KIT, cap, short manifold, <i>includes 18, 16 (60 mesh)</i>		150	See page 44	Fuse replacement	1
18*		INSERT, filter	1		115523	GAUGE, pressure, fluid, not shown (on select models)	1
	15B071	Tall			119783	FITTING, tee, swivel (on models with gauge)	1
	15E288	Short					
19	115756	BUSHING, motor wire	1				
21	See page 44	INDICATOR, control pressure	1				
24	162453	NIPPLE, (1/4 npsm x 1/4 npt)	2				
26	15E022	SEAT, valve	1				

* – See page 44 for manifold type (tall or short)

Control Box and Filter

Control and Filter Parts List

Sprayer Model	Ref. 15 Manifold	Ref. 21 Indicator	Ref. 38 Pressure Control	Ref. 56 Power Cord	Ref. 91 † Cord Set Adapter	Ref. 97 * Screw	Ref. 150 Fuse
17C310 17C313	17C590 ◆	17C725	24X289 %	15J743	---	17C735	119277
17C341	15E295	15E794	24X312 ✱	253368	---	117493	119277
17C342	15E295	15E794	24X312 ✱	16W745	---	117493	119688
17C343 17C344	17C593 ❖	17C725	24X289 %	16W745	---	17C735	119688
18C268	17C593	17C725	24X289 %	253368	---	17C735	119277
17C346	17C591 ◆	17C725	24X289 %	253370 \$	242001 ✱ 287121 †	17C735	119688
17C347	17C591 ◆	17C725	24X289 %	253368	---	17C735	119277
17C348 17C349	17C591 ◆	17C725	24X289 %	253369	---	17C735	119688
17C350	17C591 ◆	17C725	24X289 %	253369	---	17C735	119277
17C351	17C591 ◆	17C725	24X289 %	253370 \$	242001 ✱ 287121 †	17C735	119688
17C384	15E295	15E794	24X312 ✱	253373	242001 ✱ 242005 ✓ 17N232 ‡	117493	119688
17C385	17C590 ◆	17C725	24X289 %	15J743 &	---	17C735	119277
17C386 17C387 17C388	17C591 ◆	17C725	24X289 %	253373	242001 ✱ 242005 ✓ 287121† 17N232✱	17C735	119688
17C389	17C592 ❖	17C725	24X312 ✱	253373	242005 ✓	17C735	119688
17C438	15E295	15E794	24X312 ✱	16W745	---	117493	119688
17D899	15E295	15E794	24X312 ✱	15J743	---	117493	119277
17D900	15E295	15E794	24X312 ✱	253370 \$	242001 ✱ 242005 ✓ 287121 †	117493	119688
17D901	15E295	15E794	24X312 ▲	16W745	---	117493	119688
826195	17C590 ◆	17C725	24X289 %	15J743	---	17C735	119277
◆ – Tall Manifold			✱ – 3000 psi (207 bar, 20.7 Mpa) Max working pressure				
❖ – Short Manifold			% – 3300 psi (228 bar, 22.8 Mpa) Max working pressure				
& – May require plug adapter 244285 (Ref. 133) in some regions							
\$ – 257805 kit also available, includes cord retainer (Ref. 90) and adapters (Ref. 91)							
✱ – Europe CEE 7/7 (Type F) plug							
✓ – China/Australia (Type I) plug							
† – European multicord; Italy (Type L), Denmark (Type K), Switzerland (Type J) plugs							
✱ – India/South Africa/Africa (Type M) plug							
‡ – Sprayer models with this cord set also require cord retainer (Ref. 90)							
* – Torque to 140-160 in-lb (15.8 - 18.1 N•m)							
‡ – India plug sans 164-1, BS 546A, Type M							

Wiring Diagrams

110/120V

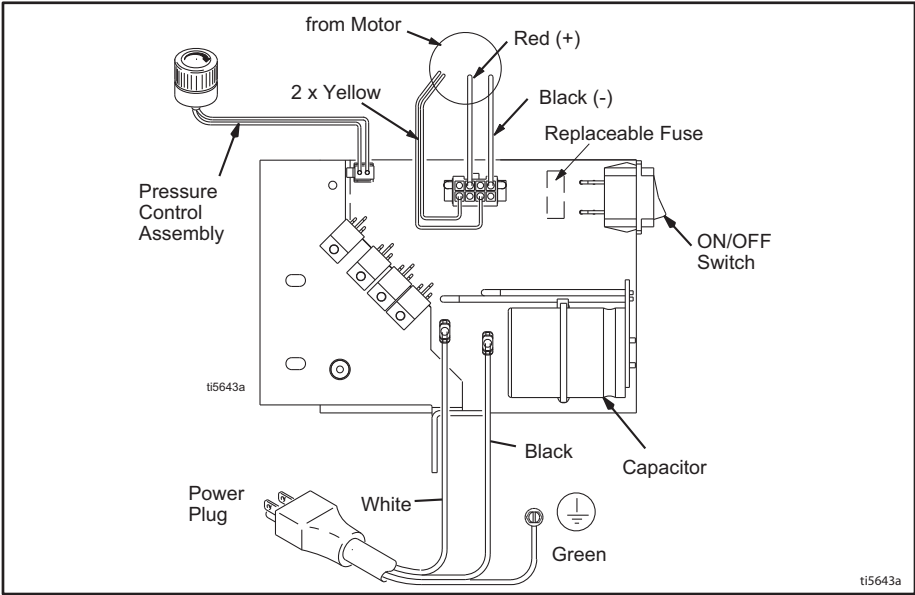

Wiring Diagrams

110V UK

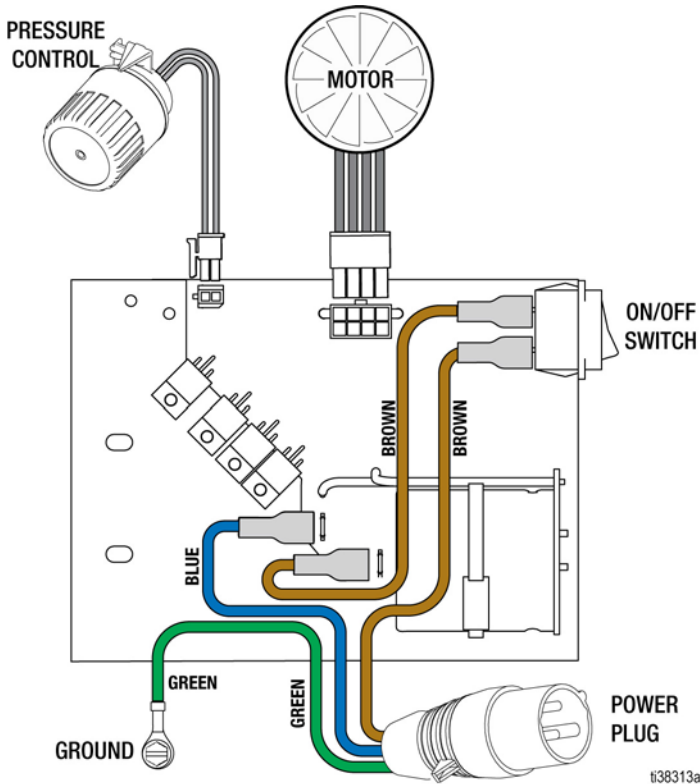

230V

230V Model

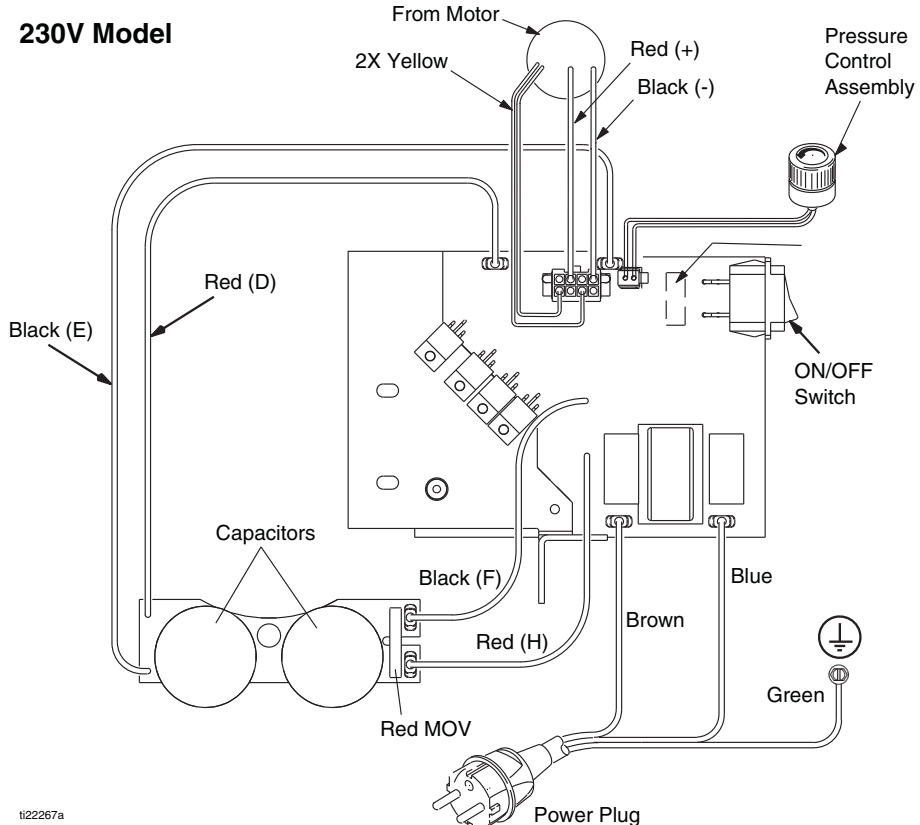

tl22267a

Technical Specifications

Technical Specifications

190/290/390		
	US	Metric
Sprayer		
Maximum fluid working pressure		
190	3000 psi	207 bar, 20.7 MPa
290/390	3300 psi	228 bar, 22.8 MPa
Maximum Delivery		
190 PC Classic, 190 PC Express	0.38 gpm	1.4 lpm
290/390 PC Classic, 390 PC, NOVA 390 PC, 190 PC Express (17C384)	0.47 gpm	1.8 lpm
Maximum Tip Size		
190 PC Classic, 190 PC Express	0.019	0.019
290/390 PC Classic, 390 PC, NOVA 390 PC 190 PC Express (17C384)	0.021	0.021
Fluid Outlet	1/4 in. npsm	1/4 in. npsm
Cycles	700 per gallon	185 per liter
Generator Minimum	3000 W	3000 W
110–120V, A, Hz	1Ø, 13, 50/60	
220–240V, A, Hz	1Ø, 8, 50/60	
Dimensions		
Height		
Stand	18.5 in.	47 cm
Lo-Boy	22.5 in.	57.2 cm
Hi-Boy	28.25 in. (Handle down) 38.25 in. (Handle up)	71.8 cm (Handle down) 97.2 cm (Handle up)
Length		
Stand	16 in.	40.6 cm
Lo-Boy	26.5 in.	67.3 cm
Hi-Boy	23.25 in.	59.1 cm
Width		
Stand	14 in.	35.6 cm
Lo-Boy	20 in.	50.6 cm
Hi-Boy	20.5 in.	52.1 cm
Weight		
Stand	34 lb.	15.4 kg
Lo-Boy	59 lb.	26.8 kg
Hi-Boy	68.5 lb.	31.1 kg

California Proposition 65

190/290/390		
	US	Metric
Noise** (dBa) @ 70 psi (0.48 MPa, 4.8 bar)		
Sound pressure	90 dBa	
Sound power	100 dBa	
Materials of Construction		
Wetted materials on all models	zinc- and nickel-plated carbon steel, nylon, stainless steel, PTFE, Acetal, leather, UHMWPE, aluminum, tungsten carbide, polyethylene, fluoroelastomer, urethane	
Notes		
<i>* Startup pressures and displacement per cycle may vary based on suction condition, discharge head, air pressure, and fluid type.</i>		
<i>** Sound pressure measured 3 feet (1 meter) from equipment. Sound power measured per ISO-3744.</i>		

California Proposition 65

CALIFORNIA RESIDENTS

 **WARNING:** Cancer and reproductive harm –
www.P65warnings.ca.gov.

Graco Standard Warranty

Graco Standard Warranty

Graco warrants all equipment referenced in this document which is manufactured by Graco and bearing its name to be free from defects in material and workmanship on the date of sale to the original purchaser for use. With the exception of any special, extended, or limited warranty published by Graco, Graco will, for a period of twelve months from the date of sale, repair or replace any part of the equipment determined by Graco to be defective. This warranty applies only when the equipment is installed, operated and maintained in accordance with Graco's written recommendations.

This warranty does not cover, and Graco shall not be liable for general wear and tear, or any malfunction, damage or wear caused by faulty installation, misapplication, abrasion, corrosion, inadequate or improper maintenance, negligence, accident, tampering, or substitution of non-Graco component parts. Nor shall Graco be liable for malfunction, damage or wear caused by the incompatibility of Graco equipment with structures, accessories, equipment or materials not supplied by Graco, or the improper design, manufacture, installation, operation or maintenance of structures, accessories, equipment or materials not supplied by Graco.

This warranty is conditioned upon the prepaid return of the equipment claimed to be defective to an authorized Graco distributor for verification of the claimed defect. If the claimed defect is verified, Graco will repair or replace free of charge any defective parts. The equipment will be returned to the original purchaser transportation prepaid. If inspection of the equipment does not disclose any defect in material or workmanship, repairs will be made at a reasonable charge, which charges may include the costs of parts, labor, and transportation.

THIS WARRANTY IS EXCLUSIVE, AND IS IN LIEU OF ANY OTHER WARRANTIES, EXPRESS OR IMPLIED, INCLUDING BUT NOT LIMITED TO WARRANTY OF MERCHANTABILITY OR WARRANTY OF FITNESS FOR A PARTICULAR PURPOSE.

Graco's sole obligation and buyer's sole remedy for any breach of warranty shall be as set forth above. The buyer agrees that no other remedy (including, but not limited to, incidental or consequential damages for lost profits, lost sales, injury to person or property, or any other incidental or consequential loss) shall be available. Any action for breach of warranty must be brought within two (2) years of the date of sale.

GRACO MAKES NO WARRANTY, AND DISCLAIMS ALL IMPLIED WARRANTIES OF MERCHANTABILITY AND FITNESS FOR A PARTICULAR PURPOSE, IN CONNECTION WITH ACCESSORIES, EQUIPMENT, MATERIALS OR COMPONENTS SOLD BUT NOT MANUFACTURED BY GRACO. These items sold, but not manufactured by Graco (such as electric motors, switches, hose, etc.), are subject to the warranty, if any, of their manufacturer. Graco will provide purchaser with reasonable assistance in making any claim for breach of these warranties.

In no event will Graco be liable for indirect, incidental, special or consequential damages resulting from Graco supplying equipment hereunder, or the furnishing, performance, or use of any products or other goods sold hereto, whether due to a breach of contract, breach of warranty, the negligence of Graco, or otherwise.

FOR GRACO CANADA CUSTOMERS

The Parties acknowledge that they have required that the present document, as well as all documents, notices and legal proceedings entered into, given or instituted pursuant hereto or relating directly or indirectly hereto, be drawn up in English. Les parties reconnaissent avoir convenu que la rédaction du présente document sera en Anglais, ainsi que tous documents, avis et procédures judiciaires exécutés, donnés ou intentés, à la suite de ou en rapport, directement ou indirectement, avec les procédures concernées.

Graco Information

For the latest information about Graco products, visit www.graco.com.

For patent information, see www.graco.com/patents.

TO PLACE AN ORDER, contact your Graco distributor or call 1-800-690-2894 to identify the nearest distributor.

All written and visual data contained in this document reflects the latest product information available at the time of publication.

Graco reserves the right to make changes at any time without notice.

Original instructions. This manual contains English. MM 334567

Graco Headquarters: Minneapolis
International Offices: Belgium, China, Japan, Korea

GRACO INC. AND SUBSIDIARIES • P.O. BOX 1441 • MINNEAPOLIS MN 55440-1441 • USA

Copyright 2014, Graco Inc. All Graco manufacturing locations are registered to ISO 9001.

www.graco.com
Revision P, July 2021