

GX Electric Airless Sprayers

3A3212K

EN

For professional use only.

Not approved for use in explosive atmospheres or hazardous locations.

For portable airless spraying of architectural paints and coatings.

Models: GX

3000 psi (207 bar, 20.7 MPa) Maximum Working Pressure

See page 4 for additional model information.



Important Safety Instructions

Read all warnings and instructions in this manual, related manuals, and on the unit including the power cord. Be familiar with the controls and the proper usage of the equipment. Save these instructions.

Related Manuals

Gun – 311861 (FTX) 312830 (SG3)

Pump – 3A3172

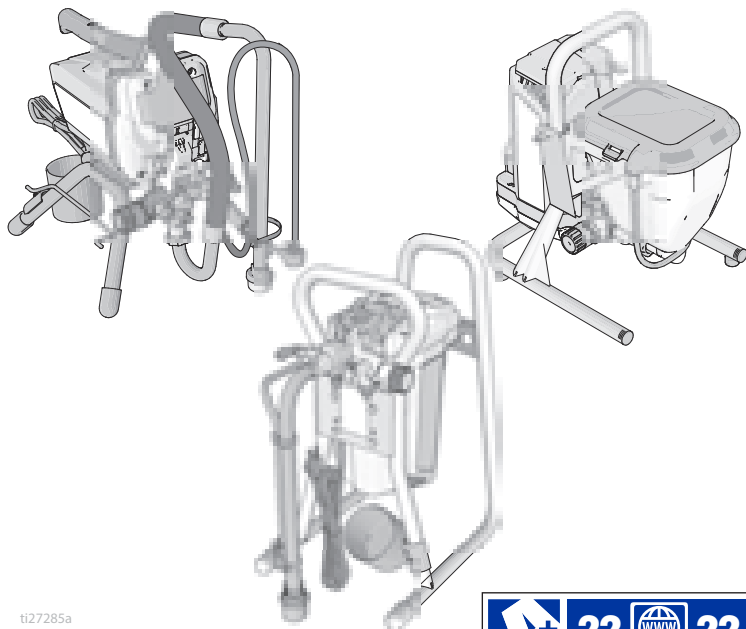

ti27285a



Use only genuine Graco replacement parts.

The use of non-Graco replacement parts may void warranty.

Contents

Models	4
Warnings	5
Know Your Sprayer	9
Stand Models	9
DI Stand Models	10
Hopper Models	11
Setup	12
Start Up	13
Pressure Relief Procedure	13
Flush Storage Fluid	14
Fill Pump	16
Fill Gun	16
How to Spray	18
Spray Tip Installation	18
Spray	18
Adjust Pressure Control	19
Tip and Pressure Selection	19
Spray Techniques	20
Triggering Gun	20
Aiming Gun	20
Spray Pattern Quality	20
Clear Tip Clog	21
Cleanup	22
Cleaning from a Pail	22
Power Flush	24
Hopper Flushing	26
Cleaning InstaClean™ Fluid Filter	28
Clean the Gun	28
Storage	29
Reference	30
Spray Tip Selection	30
Cleaning Fluid Compatibility	30
Static Grounding Instructions	31
Quick Reference	32
Maintenance	33
Airless Hoses	33
Spray Tips	33
Pump Repair	33
Troubleshooting	36
17H211, 17H214 Stand Sprayers	40
17H211, 17H214 Stand Sprayers Parts List	41

24Y680, 17G183, 17H218, 17H219, 17H221 DI Stand Sprayers	42
24Y680, 17G183, 17H218, 17H219, 17H221 DI Stand Sprayers Parts List	43
17F924, 17G184, 17H222, 17H223 Hopper Sprayers	44
17F924, 17G184, 17H222, 17H223 Hopper Sprayers Parts List	45
Pump Assembly	46
Pump Parts List	47
Wiring Diagrams	48
110/120V	48
230V	49
Technical Specifications	50
Graco Standard Warranty	53
Graco Information	54

Thank You for Your Purchase!



Before using your sprayer read this Owners Manual for complete instructions on proper use and safety warnings.

Congratulations! You have purchased a high-quality paint sprayer made by Graco Inc. This sprayer is designed to provide superior spray performance with architectural paints and coatings.

Please read the information on the material container label to determine if it can be used with your sprayer. Ask for a Safety Data Sheet (SDS) from your supplier. The container label and SDS will explain the contents of the material and the specific precautions related to it.

Models

Models

	VAC	Model	Stand	DI Stand	Hopper
 110474 Certified to CAN/CSA C22.2 No. 68 Conforms to UL 1450	120 USA	GX 19	17H211		
		FinishPro GX 19			17F924
SA & Brazil	230 Schuko®	GX 21		17H221	
CA & Brazil & Mexico	110	GX 21		24Y680	
	230 Europe Multi	GX 21		17H218	
		GX FF			17H222
	230 Schuko	GX 21		17G183	
		GX FF			17G184
	230 Schuko Asia/ANZ	GX 21		17H219	
		GX 19	17H214		
		GX 19			17H223

Warnings

The following warnings are for the setup, use, grounding, maintenance, and repair of this equipment. The exclamation point symbol alerts you to a general warning and the hazard symbols refer to procedure-specific risks. When these symbols appear in the body of this manual or on warning labels, refer back to these Warnings. Product-specific hazard symbols and warnings not covered in this section may appear throughout the body of this manual where applicable.

WARNING



GROUNDING

This product must be grounded. In the event of an electrical short circuit, grounding reduces the risk of electric shock by providing an escape wire for the electric current. This product is equipped with a cord having a grounding wire with an appropriate grounding plug. The plug must be plugged into an outlet that is properly installed and grounded in accordance with all local codes and ordinances.

- Improper installation of the grounding plug is able to result in a risk of electric shock.
- When repair or replacement of the cord or plug is required, do not connect the grounding wire to either flat blade terminal.
- The wire with insulation having an outer surface that is green with or without yellow stripes is the grounding wire.
- Check with a qualified electrician or serviceman when the grounding instructions are not completely understood, or when in doubt as to whether the product is properly grounded.
- Do not modify the plug provided; if it does not fit the outlet, have the proper outlet installed by a qualified electrician.
- This product is for use on a nominal 120V or 230V circuit and has a grounding plug similar to the plugs illustrated below.

120V US

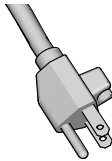

230V

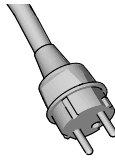

230V ANZ



ti24583b

- Only connect the product to an outlet having the same configuration as the plug.
- Do not use an adapter with this product.

Extension Cords:

- Use only a 3-wire extension cord that has a grounding plug and a grounding receptacle that accepts the plug on the product.
- Make sure your extension cord is not damaged. If an extension cord is necessary use 12 AWG (2.5mm²) minimum to carry the current that the product draws.
- An undersized cord results in a drop in line voltage and loss of power and overheating.

Conductor Size		Length
AWG (American Wire Gauge)	Metric	Maximum
16	1.5 mm ²	25 ft. (8 m)
12	2.5 mm ²	50 ft. (15 m)

WARNING



FIRE AND EXPLOSION HAZARD

Flammable fumes, such as solvent and paint fumes, in work area can ignite or explode. To help prevent fire and explosion:



- Do not spray combustible materials near an open flame or sources of ignition such as cigarettes, motors, and electrical equipment.



- Paint or solvent flowing through the equipment is able to result in static electricity. Static electricity creates a risk of fire or explosion in the presence of paint or solvent fumes. All parts of the spray system, including the pump, hose assembly, spray gun, and objects in and around the spray area shall be properly grounded to protect against static discharge and sparks. Use Graco conductive or grounded high-pressure airless paint sprayer hoses.



- Verify that all containers and collection systems are grounded to prevent static discharge. Do not use pail liners unless they are anti-static or conductive.

- Connect to a grounded outlet and use grounded extensions cords. Do not use a 3-to-2 adapter.

- Do not use a paint or a solvent containing halogenated hydrocarbons.

- Do not spray combustible liquids in a confined area.

- Keep spray area well-ventilated. Keep a good supply of fresh air moving through the area.

- Sprayer generates sparks. Keep pump assembly in a well ventilated area a least 20 feet (6.1 m) from the spray area when spraying, flushing, cleaning, or servicing. Do not spray pump assembly.

- Do not smoke in the spray area or spray where sparks or flame is present.

- Do not operate light switches, engines, or similar spark producing products in the spray area.

- Keep area clean and free of paint or solvent containers, rags, and other flammable materials.

- Know the contents of the paints and solvents being sprayed. Read all Safety Data Sheet (SDS) and container labels provided with the paints and solvents. Follow the paint and solvents manufacturer's safety instructions.

- Fire extinguisher equipment shall be present and working.

WARNING

SKIN INJECTION HAZARD



High-pressure spray is able to inject toxins into the body and cause serious bodily injury. In the event that injection occurs, **get immediate surgical treatment.**



- Do not aim the gun at, or spray any person or animal.
- Keep hands and other body parts away from the discharge. For example, do not try to stop leaks with any part of the body.



- Always use the nozzle tip guard. Do not spray without nozzle tip guard in place.



- Use Graco nozzle tips.



- Use caution when cleaning and changing nozzle tips. In the case where the nozzle tip clogs while spraying, follow the **Pressure Relief Procedure** for turning off the unit and relieving the pressure before removing the nozzle tip to clean.

- Equipment maintains pressure after power is shut off. Do not leave the equipment energized or under pressure while unattended. Follow the **Pressure Relief Procedure** when the equipment is unattended or not in use, and before servicing, cleaning, or removing parts.

- Check hoses and parts for signs of damage. Replace any damaged hoses or parts.

- This system is capable of producing 3000 psi. Use Graco replacement parts or accessories that are rated a minimum of 3000 psi.

- Always engage the trigger lock when not spraying. Verify the trigger lock is functioning properly.

- Verify that all connections are secure before operating the unit.

- Know how to stop the unit and bleed pressure quickly. Be thoroughly familiar with the controls.

EQUIPMENT MISUSE HAZARD



Misuse can cause death or serious injury.



- Always wear appropriate gloves, eye protection, and a respirator or mask when painting.
- Do not operate or spray near children. Keep children away from equipment at all times.

- Do not overreach or stand on an unstable support. Keep effective footing and balance at all times.

- Stay alert and watch what you are doing.

- Do not operate the unit when fatigued or under the influence of drugs or alcohol.

- Do not kink or over-bend the hose.

- Do not expose the hose to temperatures or to pressures in excess of those specified by Graco.

- Do not use the hose as a strength member to pull or lift the equipment.

- Do not spray with a hose shorter than 25 feet.

- Do not alter or modify equipment. Alterations or modifications may void agency approvals and create safety hazards.

- Make sure all equipment is rated and approved for the environment in which you are using it.

ELECTRIC SHOCK HAZARD



This equipment must be grounded. Improper grounding, setup, or usage of the system can cause electric shock.



- Turn off and disconnect power cord before servicing equipment.

- Connect only to grounded electrical outlets.

- Use only 3-wire extension cords.

- Ensure ground prongs are intact on power and extension cords.

- Do not expose to rain. Store indoors.

Warnings

WARNING

PRESSURIZED ALUMINUM PARTS HAZARD



Use of fluids that are incompatible with aluminum in pressurized equipment can cause serious chemical reaction and equipment rupture. Failure to follow this warning can result in death, serious injury, or property damage.

- Do not use 1,1,1-trichloroethane, methylene chloride, other halogenated hydrocarbon solvents or fluids containing such solvents.
- Do not use chlorine bleach.
- Many other fluids may contain chemicals that can react with aluminum. Contact your material supplier for compatibility.

MOVING PARTS HAZARD



Moving parts can pinch, cut, or amputate fingers and other body parts.

- Keep clear of moving parts.
- Do not operate equipment with protective guards or covers removed.
- Pressurized equipment can start without warning. Before checking, moving, or servicing equipment, follow the **Pressure Relief Procedure** and disconnect all power sources.

TOXIC FLUID OR FUMES HAZARD



Toxic fluids or fumes can cause serious injury or death if splashed in the eyes or on skin, inhaled, or swallowed.

- Read MSDSs to know the specific hazards of the fluids you are using.
- Store hazardous fluid in approved containers, and dispose of it according to applicable guidelines.

PERSONAL PROTECTIVE EQUIPMENT



Wear appropriate protective equipment when in the work area to help prevent serious injury, including eye injury, hearing loss, inhalation of toxic fumes, and burns. This protective equipment includes but is not limited to:

- Protective eyewear, and hearing protection.
- Respirators, protective clothing, and gloves as recommended by the fluid and solvent manufacturer.

CALIFORNIA PROPOSITION 65

This product contains a chemical known to the State of California to cause cancer, birth defects or other reproductive harm. Wash hands after handling.

Know Your Sprayer Stand Models

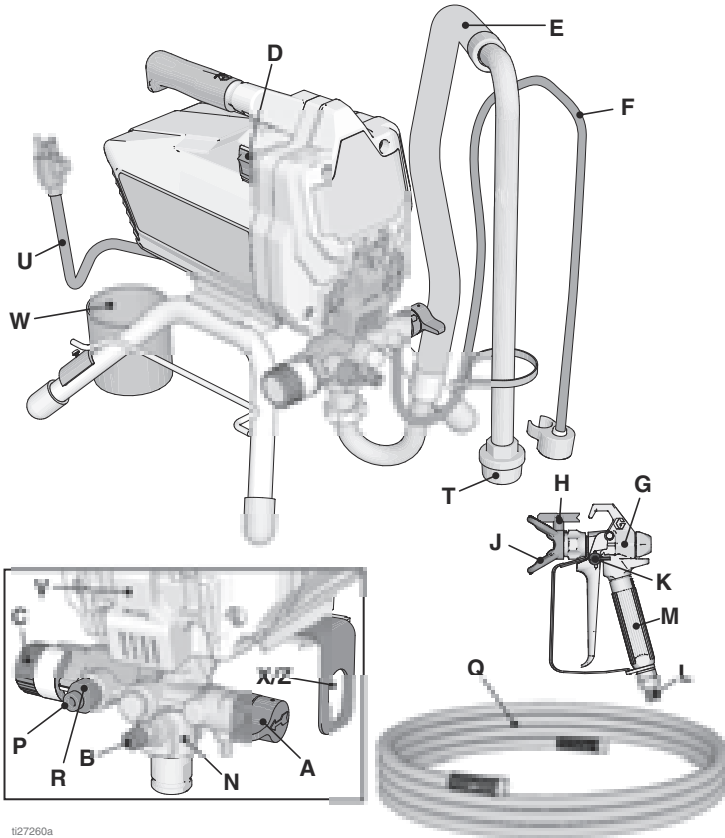

t27260a

A	Prime / Spray Valve
B	PushPrime™ Button
C	Pressure Control Knob
D	ON/OFF Switch
E	Suction Tube
F	Drain Tube (with diffuser)
G	Airless Spray Gun
H	Reversible Spray Tip
J	Tip Guard
K	Gun Trigger Lock
L	Gun Fluid Inlet Fitting
M	Gun Fluid Filter (inside handle)
N	ProXChange™ Pump (behind Easy Access Door)

P	Pump Fluid Outlet Fitting (airless hose connection)
Q	Airless Hose
R	InstaClean™ Fluid Filter (inside fluid outlet)
T	Inlet Strainer
U	Power Cord
V	Easy Access Door
W	Suction / Drain Tube Cup
X/Z	Pump & Inlet Valve Removal Tool
	Model/Serial Tag (Not shown, located on bottom of unit.)
See Quick Reference , page 32 for more information.	

Know Your Sprayer

DI Stand Models

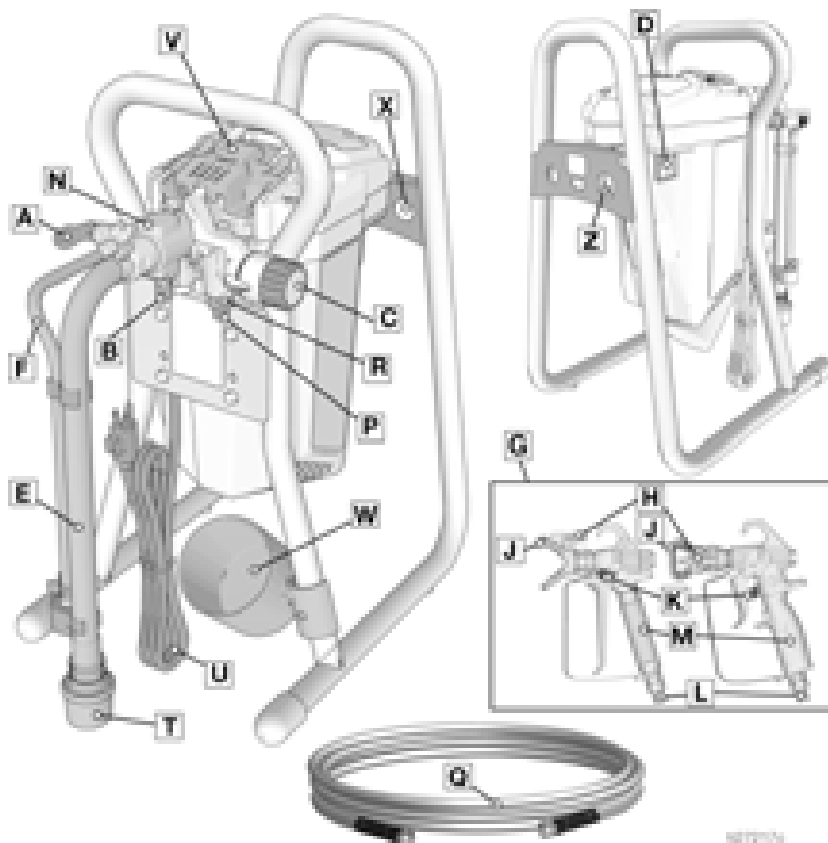

A	Prime / Spray Valve
B	PushPrime Button
C	Pressure Control Knob
D	ON/OFF Switch
E	Suction Tube
F	Drain Tube (with diffuser)
G	Airless Spray Gun
H	Reversible Spray Tip
J	Tip Guard
K	Gun Trigger Lock
L	Gun Fluid Inlet Fitting
M	Gun Fluid Filter (inside handle)
N	ProXChange™ Pump (behind Easy Access Door)

P	Pump Fluid Outlet Fitting (airless hose connection)
Q	Airless Hose
R	InstaClean™ Fluid Filter (inside fluid outlet)
T	Inlet Strainer
U	Power Cord
V	Easy Access Door with Cover
W	Suction / Drain Tube Cup
X	Pump Removal Tool
Z	Inlet Valve Removal Tool
	Model/Serial Tag (Not shown, located on bottom of unit.)
See Quick Reference , page 32 for more information.	

Hopper Models

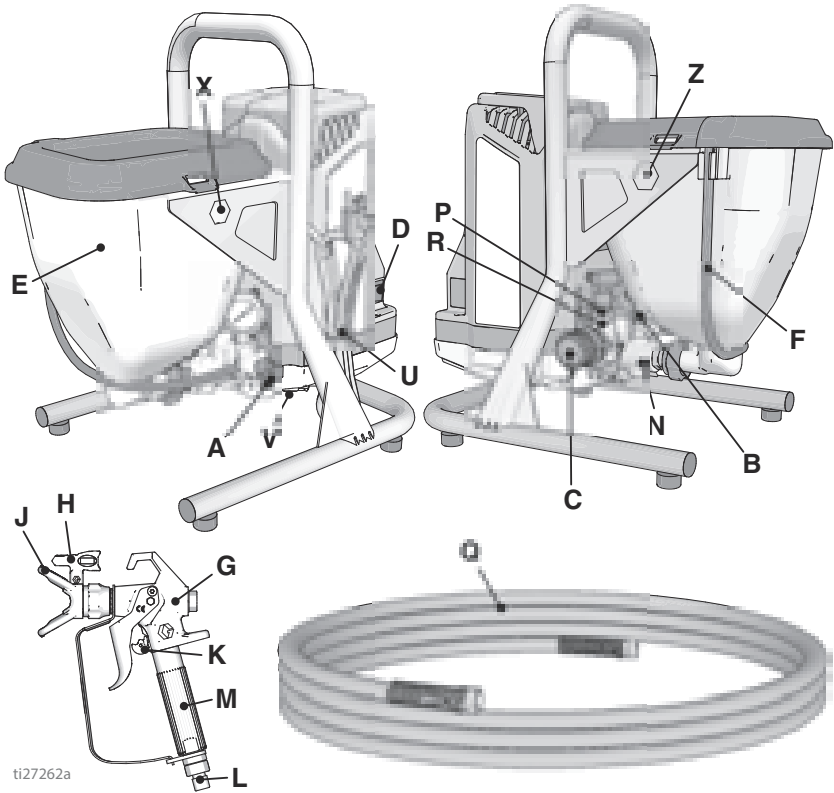

ti27262a

A	Prime / Spray Valve
B	PushPrime Button
C	Pressure Control Knob
D	ON/OFF Switch
E	Hopper
F	Drain Tube (with diffuser)
G	Airless Spray Gun FTX
H	Reversible Spray Tip, Fine Finish
J	Tip Guard
K	Gun Trigger Lock
L	Gun Fluid Inlet Fitting
M	Gun Fluid Filter (inside handle)
N	ProXChange™ Pump (behind Easy Access Door)
P	Pump Fluid Outlet Fitting (airless hose connection)

Q	Airless Hose
R	InstaClean™ Fluid Filter (inside fluid outlet)
T	Inlet Strainer, inside hopper not shown
U	Power Cord
V	Easy Access Door
X	Pump Removal Tool
Z	Inlet Valve Removal Tool
	Model/Serial Tag (Not shown, located on bottom of unit.)
See Quick Reference , page 32 for more information.	

Setup

Setup

When unpacking sprayer for the first time or after long term storage perform setup procedure.

1. Connect Graco airless hose to fluid outlet. Use wrench to tighten securely.

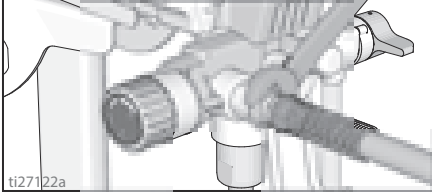

2. Connect other end of hose to gun.

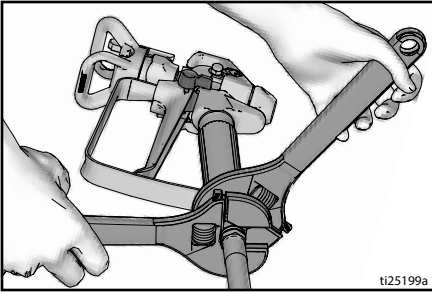

3. Use wrenches to tighten securely. If hose is already connected, make sure connections are tight.
4. Engage trigger lock.

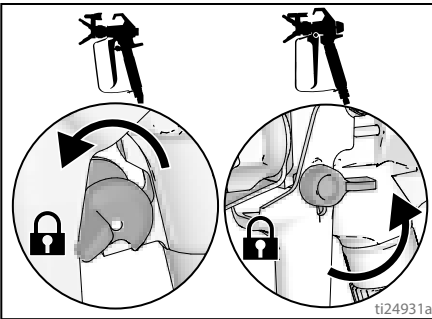

5. Remove tip guard. Do not lose the seal.

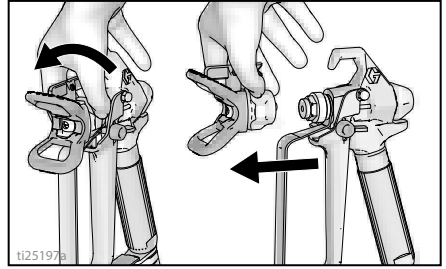

6. Turn Pressure Control Knob all the way left (counter-clockwise) to minimum pressure.

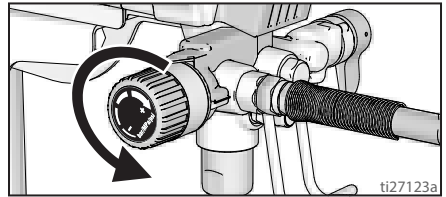

7. When unpacking sprayer for the first time remove packaging materials from inlet strainer. After long term storage check inlet strainer for clogs and debris.

Strain the Paint

Previously opened paint may contain dried paint or other debris. To avoid priming problems and spray tip clogs it is recommended to strain the paint before using. Paint strainers are available where paint is sold. Stretch a paint strainer over a clean pail and pour the paint through the strainer to capture any dried paint and debris before spraying.

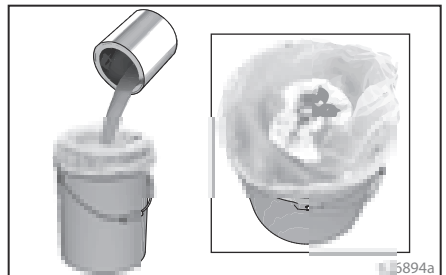

Start Up

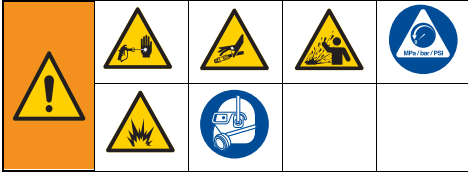

Pressure Relief Procedure



Follow the Pressure Relief Procedure whenever you see this symbol.

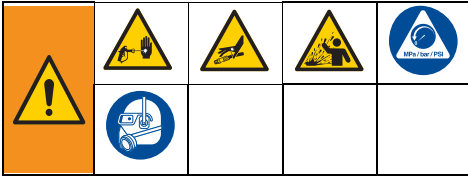

This equipment stays pressurized until pressure is manually relieved. To help prevent serious injury from pressurized fluid, such as skin injection or splashed fluid, follow the **Pressure Relief Procedure** whenever sprayer is stopped and before sprayer is cleaned or checked, and before equipment is serviced.

1. Turn ON/OFF switch to the **OFF** position.

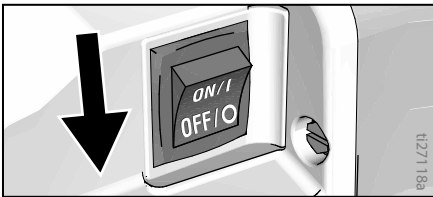

2. Engage the trigger lock. Always engage the trigger lock when sprayer is stopped to prevent the gun from being triggered accidentally.

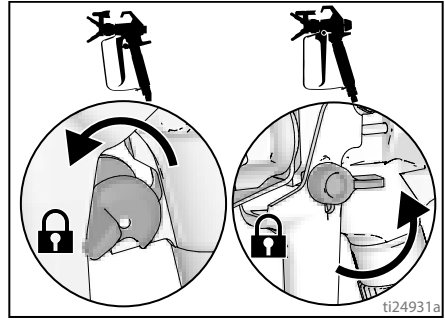

3. Turn pressure control to lowest setting.

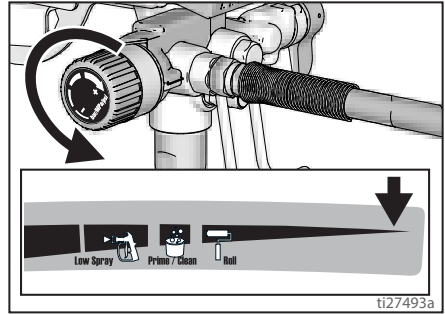

4. Put drain tube into a pail and place Prime/Spray valve in PRIME position (drain) to relieve pressure.
5. Hold the gun firmly to a pail, point gun into pail. Disengage the trigger lock and trigger the gun to relieve pressure.

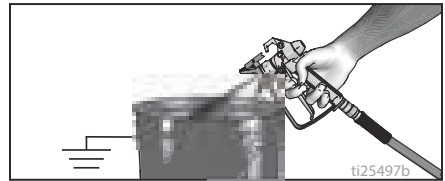

6. Engage the trigger lock.
7. If you suspect the spray tip or hose is clogged or that pressure has not been fully relieved:
 - a. **VERY SLOWLY** loosen the spray tip guard retaining nut or the hose end coupling to relieve pressure gradually.

Start Up

- b. Loosen the nut or coupling completely.
- c. Clear airless hose or spray tip obstruction.

Prime/Spray Valve

There are two types of Prime/Spray valves used on this group of Graco sprayers.

The first type of Prime/Spray valve uses a knob that can be turned between the PRIME and SPRAY position.

PRIME GX 19

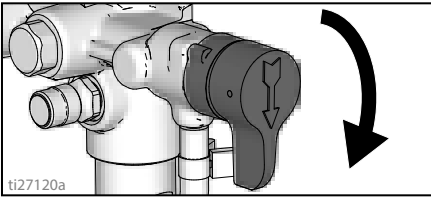

SPRAY GX 19

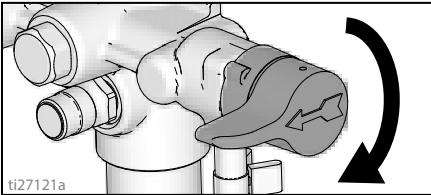

The other type of Prime/Spray valve uses a lever that can be flipped between the PRIME and SPRAY position.

PRIME FinishPro GX 19, GX 21

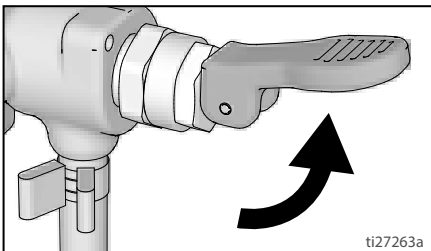

SPRAY FinishPro GX 19, GX 21

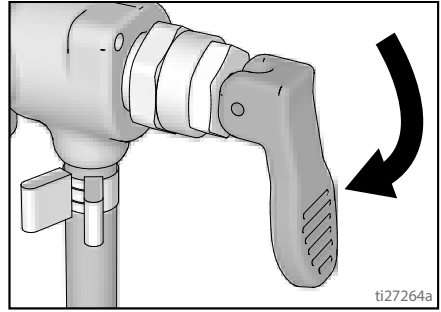

Flush Storage Fluid

This sprayer arrives from the factory with a small amount of test material in the system. **It is important that you flush this material from the sprayer before using it for the first time.** See **Cleaning Fluid Compatibility**, page 30 and **Static Grounding Instructions**, page 31 for additional information.

1. Perform **Pressure Relief Procedure**, page 13.
2. Make certain ON/OFF switch is **OFF**.

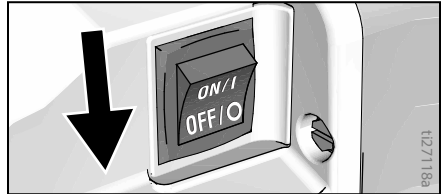

Stand Models

- a. Separate drain tube (smaller) from suction tube (larger).

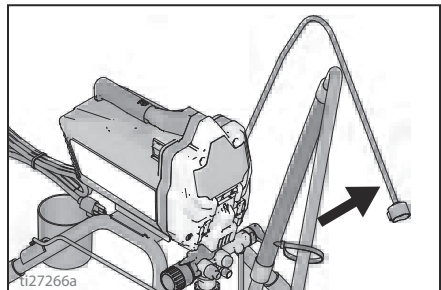

- b. Place drain tube in waste pail.

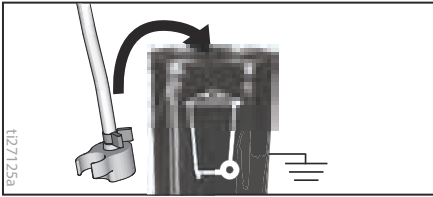

- c. Submerge suction tube in a pail partially filled with water or flushing fluid.

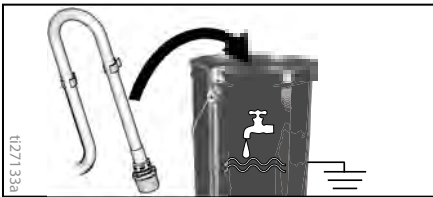

Hopper Models

- a. Lift drain tube with retainer off the hopper.

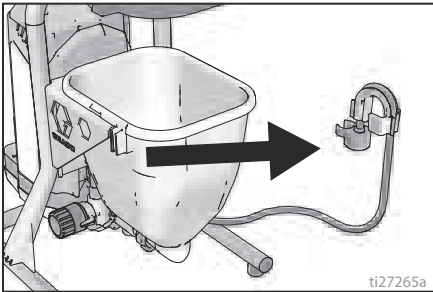

- b. While holding the drain tube retainer with drain tube parallel to the top of a waste pail twist retainer over the lip of the pail. Drain tube should now be inside the waste pail.

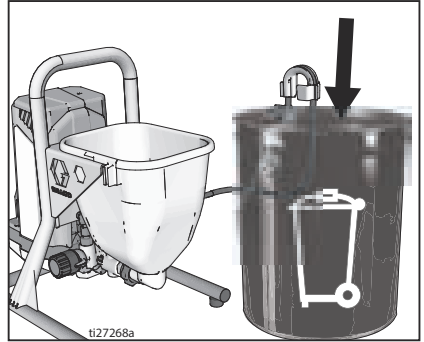

- c. Pour approximately two quarts (two liters) of water or flushing fluid into the hopper.
3. Place Prime/Spray valve in PRIME position.

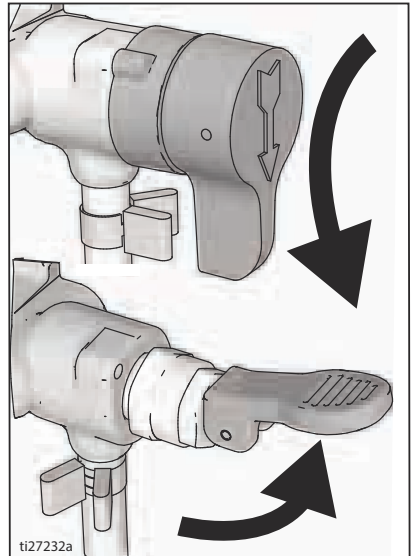

4. Plug power supply cord into a properly grounded electrical outlet.

Start Up

5. Press PushPrime button twice to loosen inlet ball.

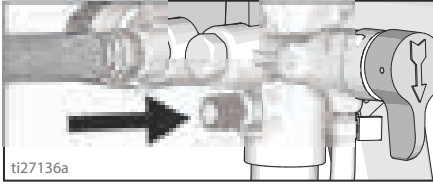

6. Align setting indicator with Prime/Clean setting on Pressure Control Knob.

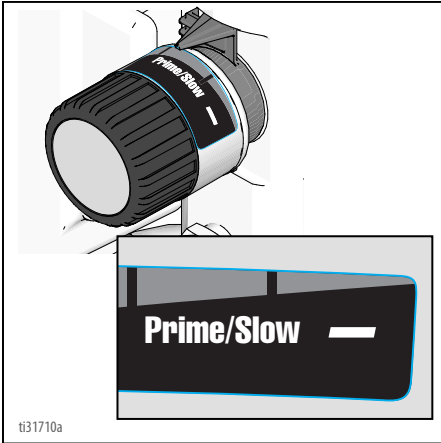

7. Turn ON/OFF switch to **ON** position.

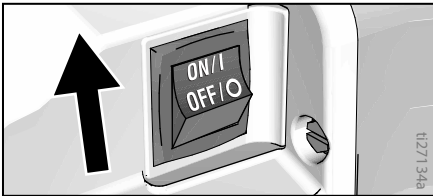

8. When sprayer starts pumping, flushing solvent and air bubbles will be purged from system. Allow fluid to flow out of drain tube into waste pail for 30 to 60 seconds. On hopper models, allow fluid to flow out of drain tube until hopper is nearly empty.
9. Turn ON/OFF switch to **OFF** position.

				
High-pressure spray is able to inject toxins into the body and cause serious bodily injury. Do not stop leaks with hand or rag.				

10. Inspect for leaks. If leaks occur, perform **Pressure Relief Procedure**, page 13, then tighten all fittings and repeat **Start Up**. If there are no leaks continue with the next step.

Fill Pump

1. Move suction tube to paint pail and submerge suction tube in paint. On hopper models and add paint to the hopper.
2. Turn ON/OFF switch to **ON** position.
3. Wait to see paint coming out of the drain tube.
4. Turn ON/OFF switch to **OFF** position.

NOTE: Some fluids may prime faster if the ON/OFF switch is momentarily turned off so the pump can slow and stop. Turn ON/OFF switch on and off several times if necessary.

Fill Gun

1. Hold gun against waste pail. Point gun into waste pail.
 - a. Disengage trigger lock.
 - b. Pull and hold gun trigger.
 - c. Turn Prime/Spray valve to **SPRAY** position.
 - d. Turn ON/OFF switch to **ON** position.

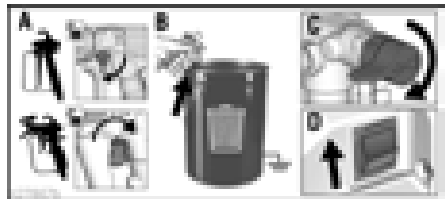

2. Trigger gun into waste pail until only paint comes out of the gun.
3. Release trigger. Engage trigger lock.
4. Transfer drain tube to paint pail and clip to suction tube. On hopper models, clip drain tube to hopper.

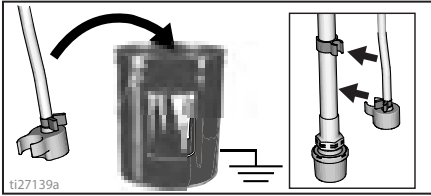

NOTE: When motor stops sprayer is ready to paint. If motor continues to run sprayer is not properly primed, repeat **Fill Pump** and **Fill Gun**.

How to Spray

How to Spray

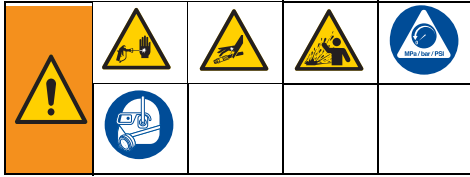

Spray Tip Installation

To prevent spray tip leaks make certain spray tip and tip guard are installed properly.

1. Perform **Pressure Relief Procedure**, page 13.
2. Engage trigger lock.
3. Verify spray tip and tip guard parts are assembled in the order shown.

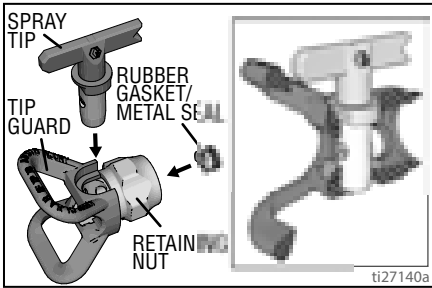

- a. Use spray tip to align gasket and seal in the tip guard.

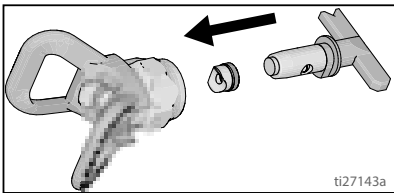

- b. Spray tip must be pushed all the way into the tip guard. Turn spray tip to push down.

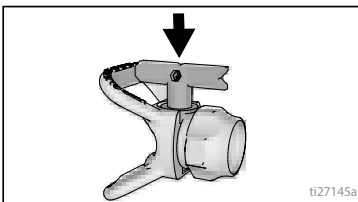

- c. Turn the arrow shaped handle on the spray tip forward to the spray position.
4. Screw spray tip assembly onto the gun and tighten.

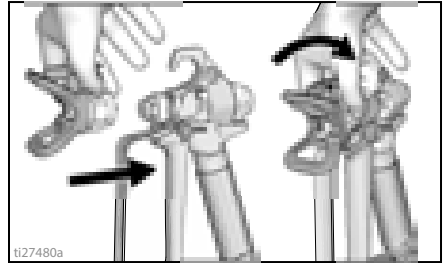

Spray

When a RAC X™ FF LP Fine Finish Low Pressure reversible spray tip is used, spraying pressure can be lowered. Spraying at a lower pressure results in less overspray and reduces spray tip wear. Adjust the sprayer pressure to minimize overspray.

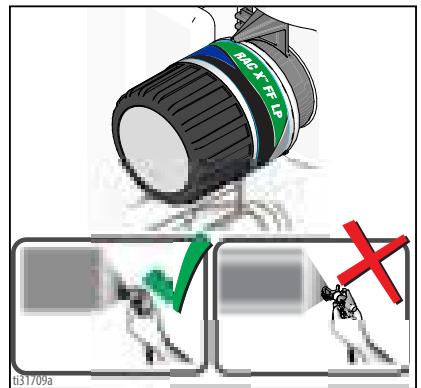

Atomized, evenly distributed fan pattern

Tails

Adjust Pressure Control

The pressure control knob allows for infinite pressure adjustment. To reduce overspray, always start at the lowest pressure setting and increase pressure to the minimum setting that results in an acceptable spray pattern.

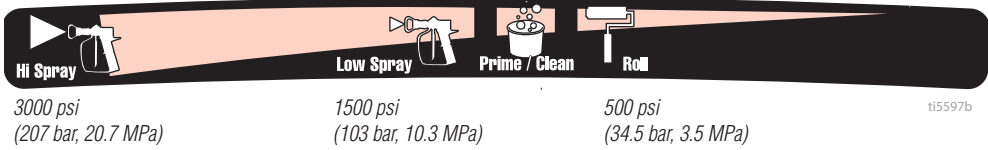

To select function, align symbol on pressure control knob with setting indicator on sprayer.

Tip and Pressure Selection

See table for recommended spray pressure for your material. Refer to paint (material) can for manufacturer's recommendations.

Maximum tip hole sizes supported by the sprayer:

- GXFF, GX19, FinishPro GX19: 0.019 in. (0.48 mm)
- GX21: 0.021 in. (0.53 mm)

	Coatings				
	Stains	Enamels	Primers	Interior Paints	Exterior Paints
Spray Pressure Setting	Low Spray	Low Spray	High Spray	High Spray	High Spray
Tip Hole Size					
0.011 in. (0.28 mm)	✓				
0.013 in. (0.33 mm)	✓	✓	✓	✓	
0.015 in. (0.38 mm)		✓	✓	✓	✓
0.017 in. (0.43 mm)			✓	✓	✓
0.019 in. (0.48 mm)					✓
0.021 in. (0.53 mm)					✓

Fine Finish Tips

Fine Finish tips have an additional orifice that provides a finer atomization of the material.

	Coatings				
	Polyurethane	Lacquer	Sanding Sealer	Enamels	Latex
Spray Pressure Setting	Low Spray	Low Spray	Low Spray	High Spray	High Spray
0.008 in. (0.20 mm)	✓	✓	✓		
0.010 in. (0.25 mm)	✓	✓	✓		
0.012 in. (0.31 mm)				✓	
0.014 in. (0.36 mm)					✓
0.016 in. (0.41 mm)					✓

How to Spray

Spray Techniques

Use a piece of scrap cardboard to practice these basic spraying techniques before you begin spraying the surface.

- Hold gun 12 in. (30 cm) from surface and aim straight at surface. Tilting gun to direct spray angle causes an uneven finish.

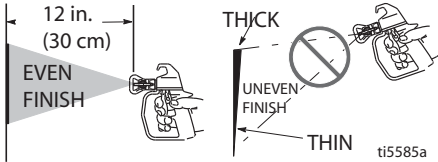

- Flex wrist to keep gun pointed straight. Fanning gun to direct spray at angle causes uneven finish.

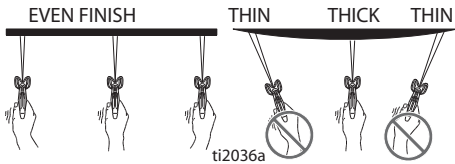

Triggering Gun

Pull trigger after starting stroke. Release trigger before end of stroke. Gun must be moving when trigger is pulled and released.

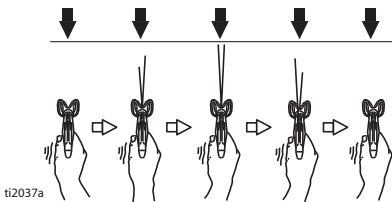

Aiming Gun

Aim center of spray of gun at bottom edge of previous stroke, overlapping each stroke by half.

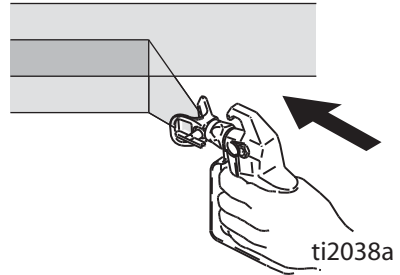

Spray Pattern Quality

A good spray pattern is evenly distributed as it hits the surface.

- Spray should be atomized (evenly distributed, no gaps at edges).

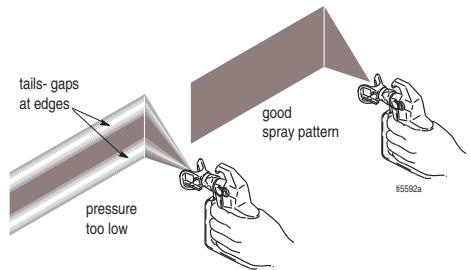

If tails persist when spraying at the highest spray pressure:

- Spray tip may be worn. See **Spray Tip Selection**, page 30.
- A smaller spray tip may be needed.
- Material may need to be thinned. If material needs to be thinned follow manufacturer's recommendations.

Clear Tip Clog

In the event that particles or debris clog the spray tip, this sprayer is designed with a reversible spray tip that quickly and easily clears the particles without disassembling the sprayer.

See **Strain the Paint**, page 12 for additional information.

1. Release trigger. Engage trigger lock. Rotate spray tip to unclog position. Disengage trigger lock. Trigger gun at waste area to clear clog.

Unclog

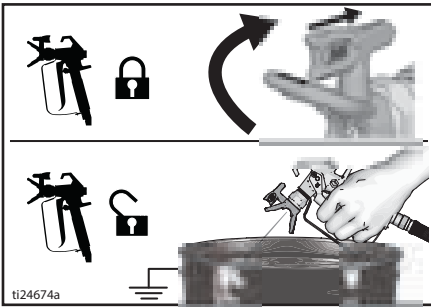

2. Engage trigger lock. Rotate spray tip back to spray position. Disengage trigger lock and continue spraying.

Spray

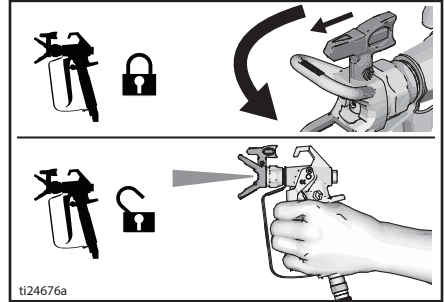

Cleanup

Cleanup

Cleaning the sprayer after each use results in a trouble free start up the next time the sprayer is used.

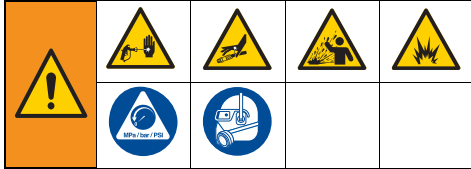

Cleaning from a Pail (Stand Models Only)

Pail flushing only works with models that have a suction tube.

- For long term storage refer to **Storage**, page 29.
 - See **Cleaning Fluid Compatibility**, page 30 and **Static Grounding Instructions**, page 31.
1. Perform **Pressure Relief Procedure**, page 13.
 2. Remove tip guard and spray tip.

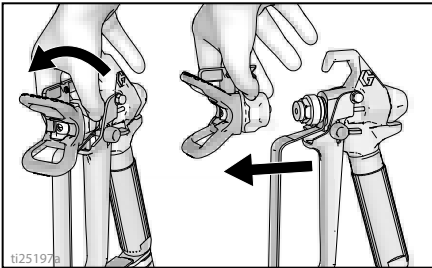

3. Remove suction tube and drain tube from paint, wipe excess paint off outside.



4. Separate drain tube (smaller) from suction tube (larger).

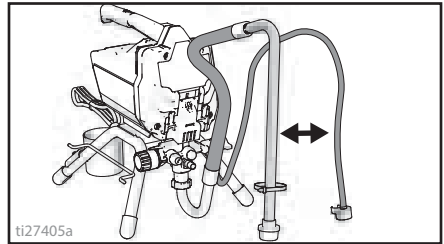

5. Place empty waste and flushing fluid pails side by side.
6. Place suction tube in flushing fluid. Use water for water based paint and mineral spirits or compatible oil-based flushing solvent for oil-based paint. Place drain tube in waste pail.

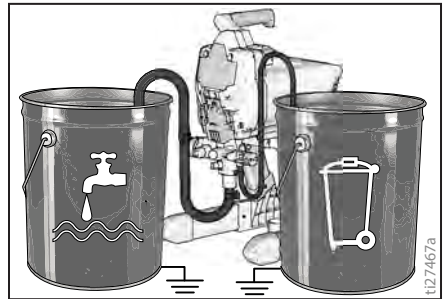

7. Turn pressure control knob to the Prime/Clean setting.

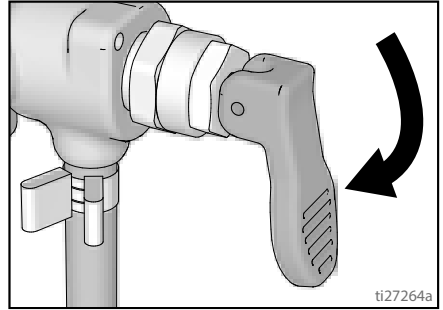
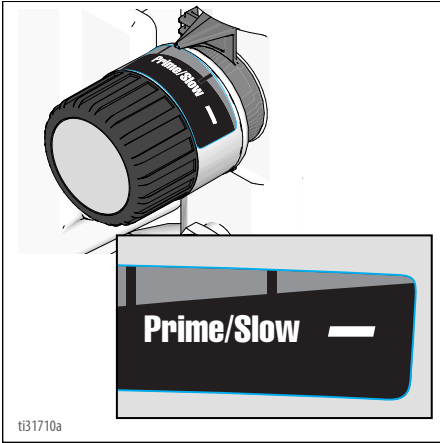

8. Place Prime/Spray valve in PRIME position.
9. Turn ON/OFF switch to **ON** position.
10. Flush until approximately 1/3 of the flushing fluid is emptied from the pail.
11. Turn ON/OFF switch to **OFF** position.

NOTE: Step 12 is for returning paint in airless paint hose to paint pail. One 50 ft (15 m) hose holds approximately 1 quart (1 liter) of paint.

12. To recover paint in hose:
 - a. Hold gun firmly to the paint pail.
 - b. Point gun into paint pail.
 - c. Disengage trigger lock.
 - d. Pull and hold gun trigger.
 - e. Place Prime/Spray valve in SPRAY position.

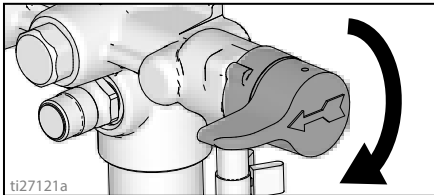

- f. Turn ON/OFF switch to **ON** position.
- g. Continue to hold gun trigger until you see paint diluted with flushing fluid starting to come out of gun.

13. While continuing to trigger gun, quickly move gun to redirect spray into waste pail. Continue triggering gun into waste pail until flushing fluid dispensed from gun is relatively clear.

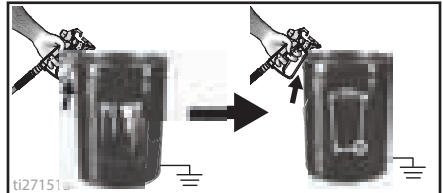

14. Stop triggering gun. Engage the trigger lock.

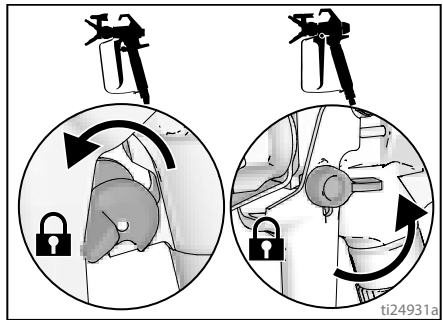

Cleanup

15. Place Prime/Spray valve in PRIME position.

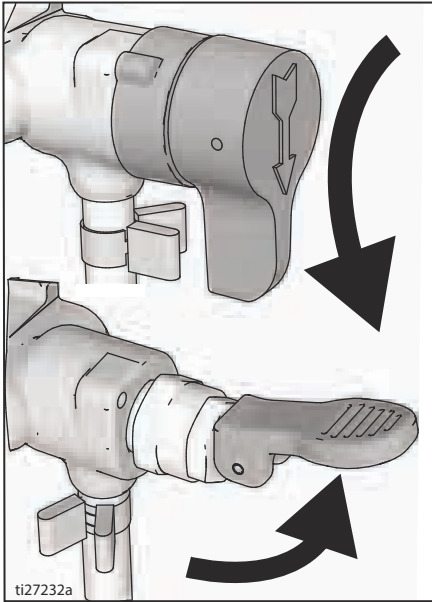

16. Turn ON/OFF switch to **OFF** position.
17. Clean filter. See **Cleaning Insta-Clean™ Fluid Filter**, page 28.
18. Fill unit with Pump Armor™ fluid. See **Storage**, page 29.

Power Flush

(GX 21, Water-based materials Only)

Power flushing is a faster method of flushing. It can only be used after spraying water-based coatings.

1. Perform **Pressure Relief Procedure**, page 13.
2. Remove spray tip and tip guard assembly from gun and place in waste pail.

3. Place empty waste and paint pails side by side.

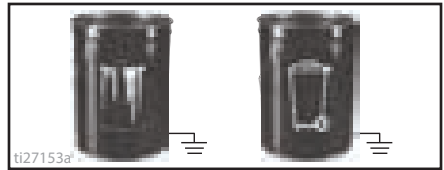

4. Lift suction tube and drain tube from paint pail. Let paint drain into the pail.
5. Place suction and drain tube in waste pail.
6. Turn Pressure Control knob to the Prime/Clean setting.

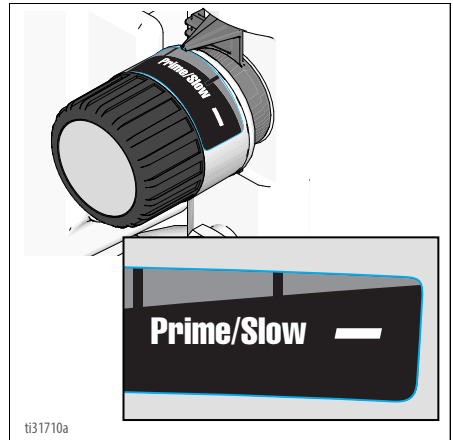

7. Screw power flush attachment valve to garden hose. Close valve.

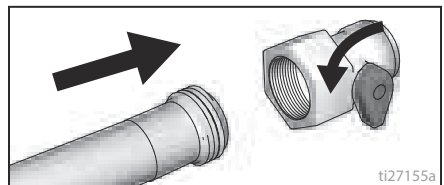

8. Turn on water. Open valve. Rinse paint off suction tube, drain tube and inlet strainer then close valve.

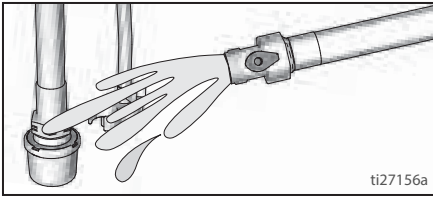

9. Unscrew inlet strainer from suction tube. Place inlet strainer rinse in waste pail.

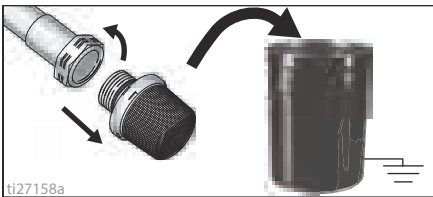

10. Connect garden hose to suction tube with Power Flush attachment valve. Leave drain tube in waste pail.

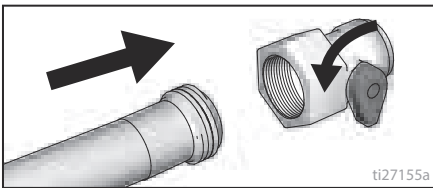

11. Turn ON/OFF switch to **ON** position.
12. Open Power flush attachment valve.

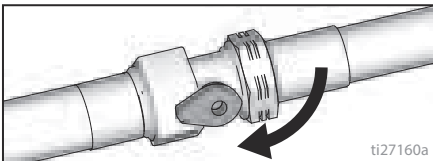

13. Circulate water through sprayer, into waste pail, for 20 seconds.

14. Turn ON/OFF switch to **OFF** position.

NOTE: Step 15 is for returning paint in hose to paint pail. One 50 ft (15 m) hose holds approximately 1 quart (1 liter) of paint.

15. To recover paint in hose:

- Hold gun firmly to the paint pail.
- Point gun into paint pail.
- Disengage trigger lock.
- Pull and hold gun trigger.
- Place Prime/Spray valve in **SPRAY** position.

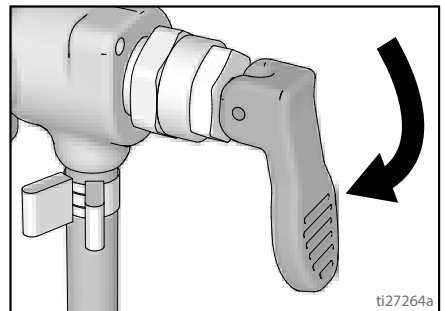
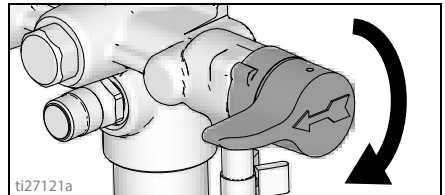

- Turn ON/OFF switch to **ON** position.
- Continue to hold gun trigger until you see paint diluted with flushing fluid starting to come out of gun.

16. While continuing to trigger gun, quickly move gun to redirect spray into waste pail. Continue triggering gun into waste pail until flushing fluid dispensed from gun is relatively clear.

17. Turn pressure control knob to the Prime/Clean setting.

Cleanup

18. Stop triggering gun. Engage the trigger lock.

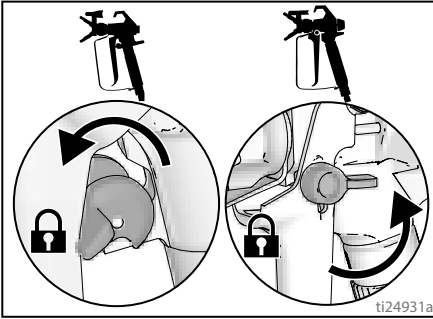

19. Place Prime/Spray valve in PRIME position.

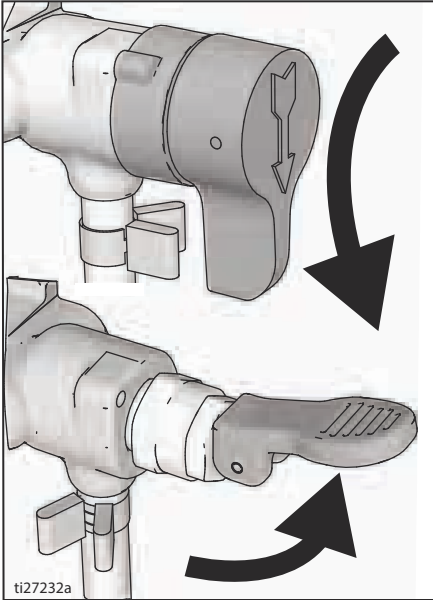

20. Turn ON/OFF switch to OFF position.

Hopper Flushing (Hopper Models Only)

See **Cleaning Fluid Compatibility**, page 30.

1. Perform **Pressure Relief Procedure**, page 13.
2. Pour any remaining material out of the hopper.

3. Remove tip guard and Spray Tip. For additional information, see **Clean the Gun**, page 28.

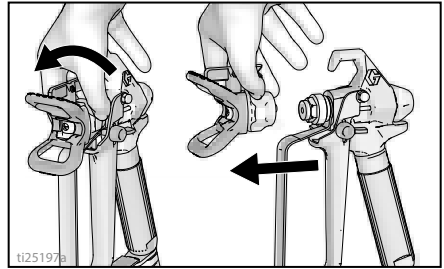

4. Remove drain tube from paint hopper, wipe excess paint off outside.

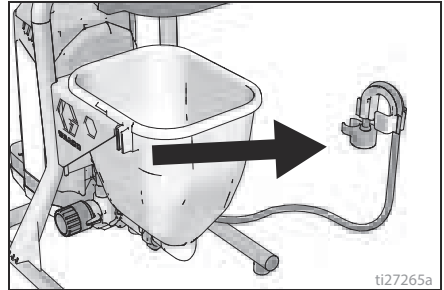

5. Place drain tube in waste pail.

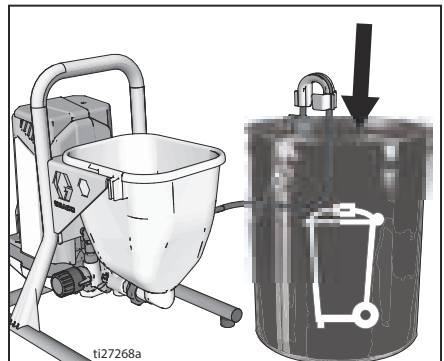

6. Pour flushing fluid into the hopper. Use water for water-based paint and mineral spirits for oil-based paint.

7. Turn pressure control knob to the Prime/Clean setting.

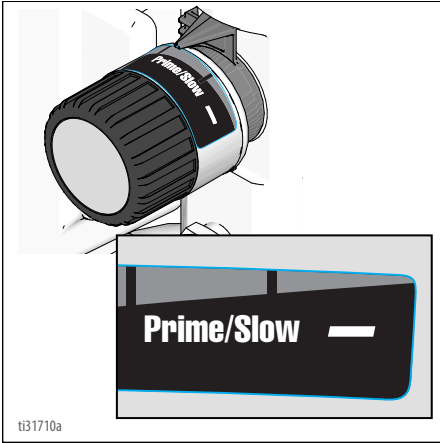

8. Turn ON/OFF switch to **ON** position.
 9. Flush until approximately 1/3 of the flushing fluid is emptied from the hopper.
 10. Turn ON/OFF switch to **OFF** position.
- NOTE:** Step 11 is for returning paint in hose to paint pail. One 50 ft (15 m) hose holds approximately 1 quart (1 liter) of paint.
11. To recover paint in hose:

- a. Point gun into paint pail.
- b. Disengage trigger lock.
- c. Pull and hold gun trigger.
- d. Place Prime/Spray valve in **SPRAY** position.

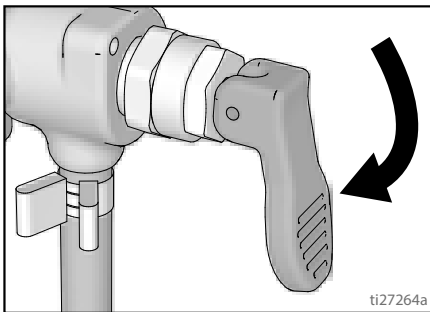

- e. Turn ON/OFF switch to **ON** position.

- f. Continue to hold gun trigger until you see paint diluted with flushing fluid starting to come out of gun.

12. While continuing to trigger gun, quickly move gun to redirect spray into waste pail. Continue triggering gun into waste pail until flushing fluid dispensed from gun is relatively clear.

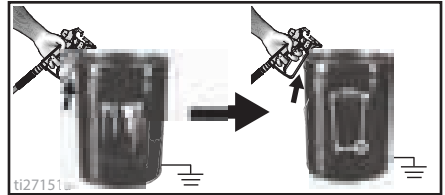

13. Stop triggering gun. Engage the trigger lock.

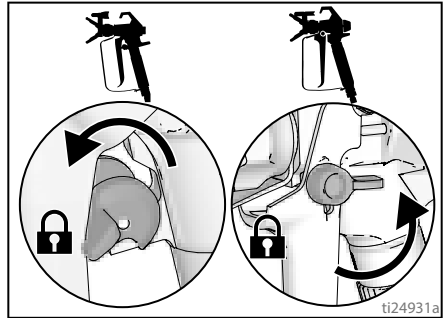

14. Place Prime/Spray valve in **PRIME** position.

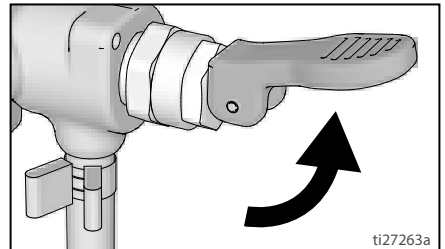

15. Turn ON/OFF switch to **OFF** position.
16. On sprayers with a filter, see **Cleaning InstaClean™ Fluid Filter**, page 28.
17. Fill unit with Pump Armor™ storage fluid. See **Storage**, page 29.

Cleaning InstaClean™ Fluid Filter

(Optional)

The InstaClean Fluid Filter prevents particles from entering paint hose. After each use, remove and clean it to ensure peak performance.

1. Perform **Pressure Relief Procedure**, page 13.
2. Disconnect airless spray hose (A) from sprayer.
3. Unscrew outlet fitting (B).
4. Remove InstaClean Fluid Filter (C).

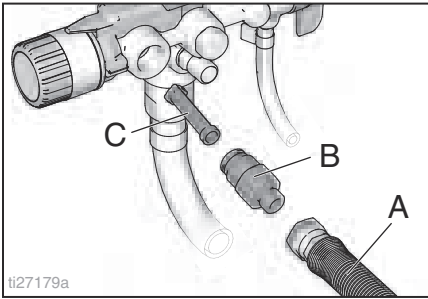

5. Check InstaClean Fluid Filter (C) for debris. If needed, clean filter with water or flushing solvent and a soft brush.
 - a. Install closed (square) end of InstaClean Fluid Filter (C) in sprayer.
 - b. Screw outlet fitting (B) into sprayer.
6. Tighten outlet fitting and reconnect hose (A) to sprayer. Use wrench to tighten securely.

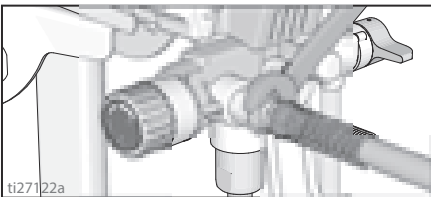

Clean the Gun

1. Clean gun fluid filter with water or flushing fluid and a brush every time you flush the system. Replace gun filter if damaged.

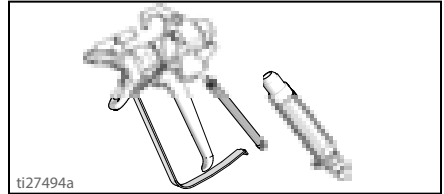

2. Remove spray tip and tip guard assembly and clean with water or flushing fluid and a brush.

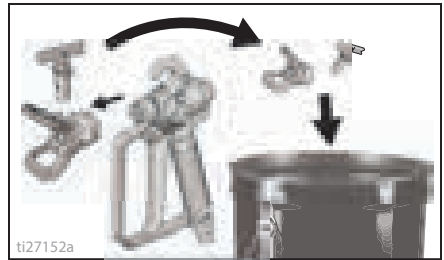

3. Wipe paint off outside of gun using a soft cloth moistened with water or flushing fluid.

Storage

With proper storage, the sprayer will be ready to use the next time it is needed.

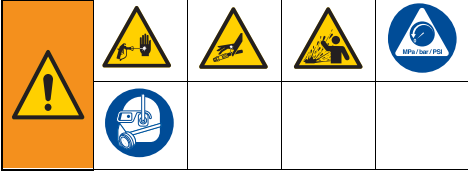

Always circulate Pump Armor storage fluid through system after cleaning. Water left in sprayer will corrode and damage pump. Follow **Cleanup**, page 22, or **Power Flush**, page 24.

- Before storing sprayer make sure all water is drained out of sprayer and hoses.
 - Do not allow water to freeze in sprayer or hose.
 - Do not store sprayer under pressure.
 - Store sprayer indoors.
1. Perform **Pressure Relief Procedure**, page 13.
 2. On stand models place suction tube in Pump Armor fluid bottle and drain tube in waste pail.

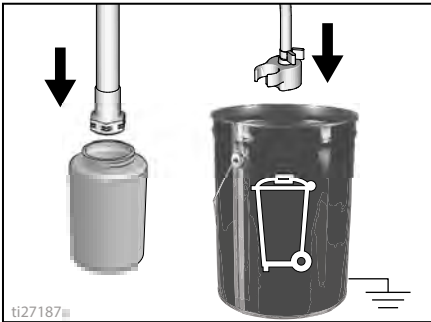

3. On hopper models pour Pump Armor into the hopper and place drain tube in waste pail.

4. Place Prime/Spray valve in PRIME position.

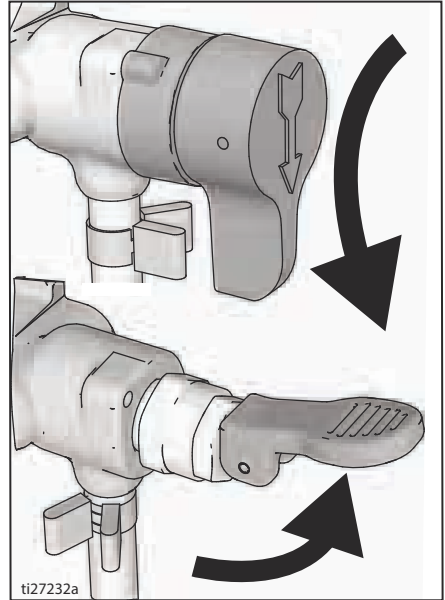

5. Turn ON/OFF switch to **ON** position.
6. Turn pressure control knob clockwise until the pump turns on.

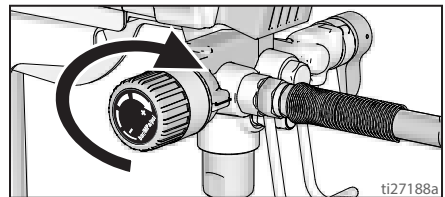

7. When storage fluid comes out of drain tube (5-10 seconds) turn ON/OFF switch to **OFF** position.
8. Place Prime/Spray valve in **SPRAY** position to keep storage fluid in sprayer during storage.
9. Secure a plastic bag around suction and drain tube to catch any drips.

Reference

Spray Tip Selection

Selecting Tip Size

Spray tips come in a variety of hole sizes for spraying a range of fluids. Your sprayer includes a tip for use in most paint spraying applications. Use coatings tables on page 19 to determine the range of recommended tip hole sizes for each fluid type.

Hints:

- As you spray, the tip wears and enlarges. Starting with a tip hole size smaller than the maximum will allow you to spray within the rated flow capacity of the sprayer.
- Use larger tip hole sizes with thicker coatings and smaller tip hole sizes with thinner coatings.
- Tips wear with use and need periodic replacement.
- Tip hole size controls flow rate - the amount of paint that comes out of the gun.

Fan Width

Fan width is the size of the spray pattern, which determines the area covered with each stroke.

Hints:

- Select a fan width best suited to the surface being sprayed.
- Wider fans allow provide better coverage on broad, open surfaces.
- Narrower fans provide better control on small, confined surfaces.

Understanding Tip Number

The last three digits of tip number (i.e.: 221413) contain information about hole size and fan width on surface when gun is held 12 in. (30.5 cm) from surface being sprayed.

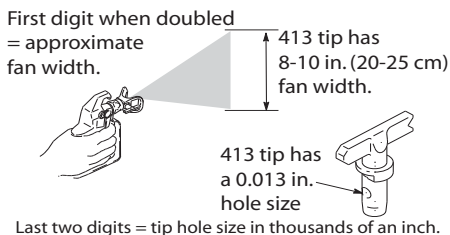





Cleaning Fluid Compatibility

Oil- or Water-based Materials

- When spraying **water-based** materials, flush the system thoroughly with water.
- When spraying **oil-based** materials, flush the system thoroughly with mineral spirits or compatible, oil-based flushing fluid.
- To spray **water-based** materials **after spraying oil-based** materials, flush the system thoroughly with water first. The water flowing out of drain tube should be clear and solvent-free **before** you begin spraying the water-based material.

- To spray **oil-based** materials **after spraying water-based** materials, flush the system thoroughly with mineral spirits or a compatible oil-based flushing solvent first. The solvent flowing out of the drain tube should not contain any water. When flushing with solvents with compatible oil-based flushing fluids always follow **Static Grounding Instructions**, page 31.
- To avoid fluid splashing back on your skin or into your eyes, always aim gun at inside wall of pail.

Static Grounding Instructions

				
<p>The equipment must be grounded to reduce the risk of static sparking and electric shock. An electric or static spark can cause fumes to ignite or explode. An improper ground can cause electric shock. A good ground provides an escape wire for the electric current.</p>				

Always use a metal pail for oil-based materials requiring flushing with compatible oil-based flushing fluids when sprayer is flushed or pressure is relieved.

Follow local code. Use only conductive metal pails, placed on a grounded surface such as concrete.

Do not place pail on a non-conductive surface such as paper or cardboard which interrupts grounding continuity.



Always ground a metal pail: connect a ground wire to the pail. Clamp one end to the pail and the other end to a true earth ground such as a water pipe.

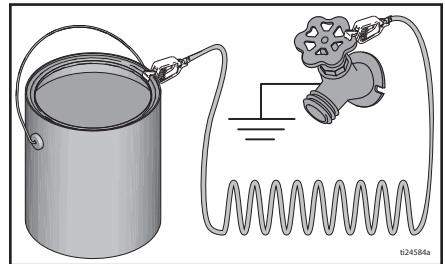

To maintain ground continuity when sprayer is flushed or pressure is relieved hold metal part of spray gun firmly to the side of a grounded metal pail, then trigger the gun.

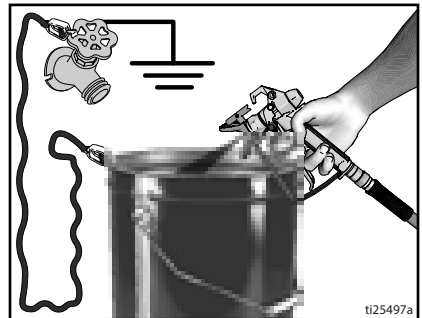

Quick Reference

Page 9	Name	Description
A	Prime/Spray valve	<ul style="list-style-type: none"> In PRIME position directs fluid to drain tube. In SPRAY position directs pressurized fluid to paint hose. Automatically relieves system pressure in over-pressure situations.
B	PushPrime button	Taps the inlet ball when pushed to loosen it.
C	Pressure control knob	Increases (clockwise) and decreases (counter-clockwise) fluid pressure in pump, hose, and spray gun. To select function, align symbol on pressure control knob with setting indicator, page 13.
D	ON/OFF switch	Turns sprayer ON and OFF.
E	Suction tube/Hopper	Draws fluid from paint pail into pump.
F	Drain tube	Drains fluid in system during priming and pressure relief.
G	Airless spray gun	Dispenses fluid.
H	Reversible spray tip	<ul style="list-style-type: none"> Atomizes fluid being sprayed, forms spray pattern and controls fluid flow according to hole size. Reverse position unclogs plugged tips without disassembly.
J	Tip guard	Reduces risk of fluid injection injury.
K	Gun trigger lock (page 12)	Prevents accidental triggering of spray gun.
L	Gun fluid inlet fitting	Threaded connection for airless hose.
M	Gun fluid filter	Filters fluid entering spray gun to reduce tip clogs.
N	ProXChange Pump	Pumps and pressurizes fluid and delivers it to paint hose.
P	Pump fluid outlet fitting	Threaded connection for airless hose.
Q	Airless hose	Transports high-pressure fluid from pump to spray gun.
R	InstaClean™ fluid filter	<ul style="list-style-type: none"> Filters fluid coming out of pump to reduce tip plugging and improve finish. Self cleans only during pressure relief.
S	Pail hanger	For transporting pail by its handle.
T	Inlet strainer	Prevents debris from entering pump.
U	Power Cord	Plugs into power source.
V	Easy Access Door	Easy Access Door permits quick access to the pump. Open pump door by pulling out on the tabs while sliding door away from the pump inlet.
W	Suction/Drain Tube Cup	Holds suction and drain hoses.
X	Pump Removal Tool	Use cut out in the frame to remove/install pump packing.
Z	Inlet Valve Removal Tool	Cut out in the frame provide the tools to quickly remove/install the inlet valve without additional tools.
	Power Flush attachment	Connects garden hose to suction tube for power flushing water-based fluids.

Maintenance

Routine maintenance is important to ensure proper operation of your sprayer.



Activity	Interval
Inspect/clean InstaClean filter, fluid inlet strainer, and gun filter.	Daily or each time you spray
Inspect motor shroud openings for blockage.	Daily or each time you spray

NOTICE

Protect the internal drive parts of this sprayer from water. Openings in shroud allow cooling of mechanical parts and electronics inside. If water gets into these openings, the sprayer could malfunction or be permanently damaged.

Airless Hoses

Check hose for damage every time you spray. Do not attempt to repair hose if hose jacket or fittings are damaged. Do not use hoses shorter than 25 ft (7.6 m). Wrench tighten, using two wrenches.

Spray Tips

- Always clean tips with compatible cleaning fluid and brush after spraying.
- Tips may require replacement after 15 gallons (57 liters) or they may last through 60 gallons (227 liters) depending on abrasiveness of paint.

Pump Repair

When pump packings wear, paint will begin to leak down outside of pump.

- Purchase a pump repair kit and install according to instructions provided with kit, before your next job.
- See **Pump Assembly**, page 46 or consult a Graco/MAGNUM authorized retailer, distributor, or service center.

Pump Removal

On FinishPro sprayers with a hopper the hopper must be removed before pump can be removed.

Always perform **Pressure Relief Procedure**, page 13 before starting any pump repairs.

1. Pull tabs on sides of the easy access door pump towards you while pushing the entire door away from the inlet end of the pump.
2. Now lift the door so that it swivels out of the way.

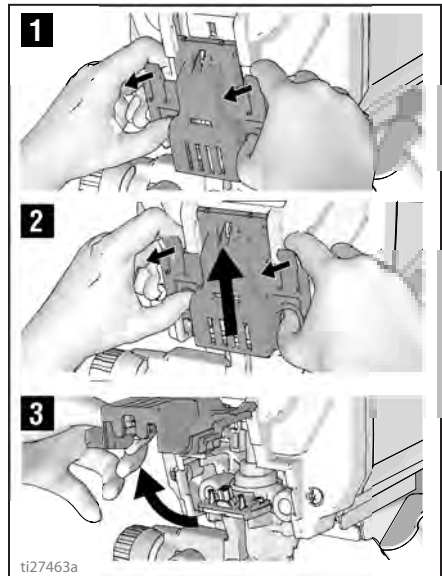

ti27463a

Maintenance

3. Slide pump assembly off the mounting pins.

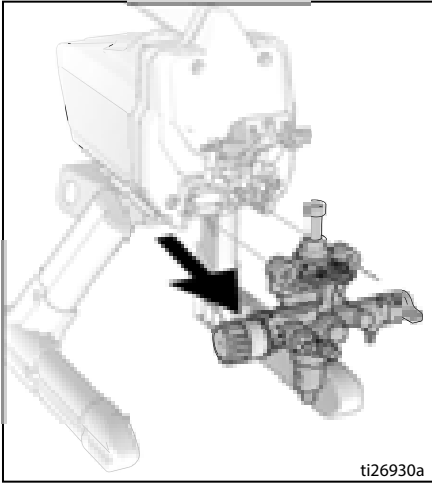

Inlet Valve Removal

An integrated tool is included in the frame to remove the inlet valve assembly from the pump. If you suspect that the inlet valve is clogged or stuck, remove the valve assembly and clean or replace.

1. Remove suction tube or hopper from sprayer.
2. Insert pump inlet into frame and loosen the inlet valve. Remove inlet valve.

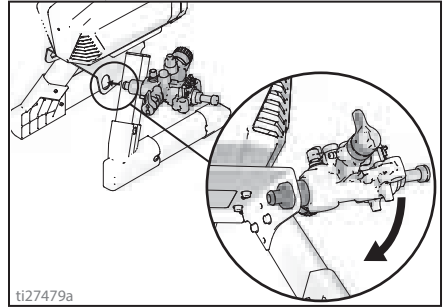

ProXChange Removal Tool

An integrated tool is included in the frame to remove the ProXChange packing assembly. See Pump repair manual for complete repair instructions.

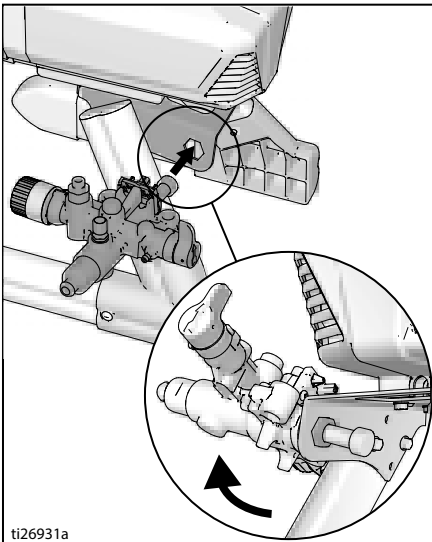

NOTICE

Do not lose the ball and spring inside the inlet valve assembly. It may fall out when the inlet valve is removed. Pump will not prime without the ball and spring.

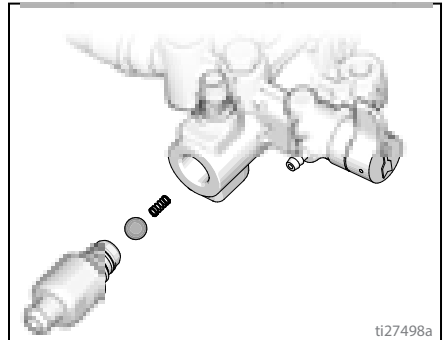

3. Clean any debris and dried paint from the cavity and replace the ball and spring. Tighten inlet valve to pump using integrated tool on the frame.

Pump Installation

1. Slide pump assembly onto the mounting pins.

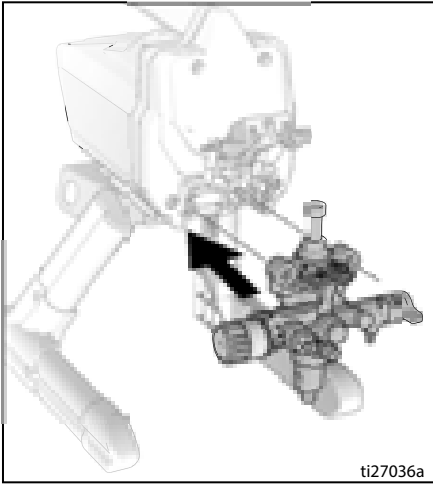

2. Move pump displacement rod up or down until cap is level with the opening in the yoke.

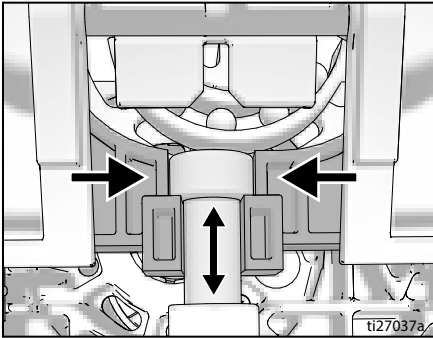

3. Swing easy access door pump door closed while pushing the entire door towards the inlet end of the pump.

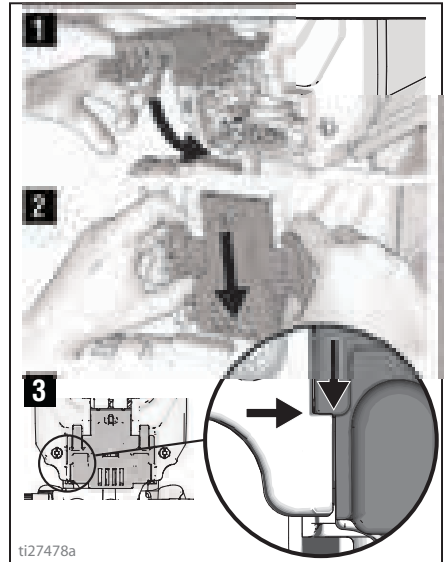

NOTE: Door must be fully closed and latched before sprayer will operate.

Troubleshooting

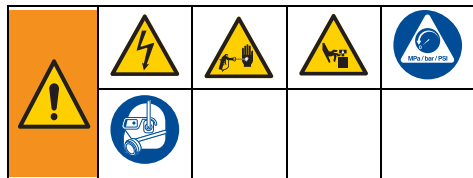

1. Follow **Pressure Relief Procedure**, page 13, before checking or repairing.
2. Solutions at the beginning of each problem listed are the most common. Start at the beginning and continue down the list to find a solution.
3. Check everything in this Troubleshooting Table before you bring the sprayer to an authorized service center.

Problem	Cause	Solution
Motor does not run: (verify sprayer is plugged in, and power switch is on)	Easy access door not fully closed.	Verify that easy access door is closed and latched. See page 35.
	Pressure control knob is set at zero pressure.	Turn pressure control knob clockwise to increase pressure setting.
	Electric outlet is not providing power.	Test outlet with known working device. Reset circuit breaker or replace fuse. Find working outlet. Reset building circuit breaker or replace fuse.
	Extension cord is damaged.	Replace extension cord. See page 5.
	Sprayer electric cord is damaged.	Check for broken insulation or wires. Replace electric cord if damaged.
	Pump is seized (Paint has hardened in pump or Water is frozen in pump.)	Turn ON/OFF switch off and unplug sprayer from outlet. If frozen do NOT try to start sprayer until it is completely thawed or it may damage the motor, control board and/or drive train. Place sprayer in warm area for several hours. Check for free moving pump by removing shroud and spinning fan. If not frozen, check for hardened paint in pump. If paint has hardened in pump. See page 33. If motor does not turn with pump removed, consult a Graco/ Magnum authorized retailer, distributor, or service center.
Motor or control is damaged.	Consult a Graco/ Magnum authorized retailer, distributor, or service center.	

Problem	Cause	Solution
<p>Sprayer runs, but pump does not prime or looses prime while in use. (Pump cycles but does not pump paint or build pressure.)</p>	Inlet valve check ball is stuck.	Press PushPrime button to dislodge the ball allowing pump to prime properly, OR Power Flush sprayer, see page 24.
	Prime/Spray Valve is in SPRAY position.	Turn Prime/Spray Valve down to PRIME position until paint exits drain tube. The pump is now primed.
	Pump was not primed with flushing fluid. (Thick fluids may not prime if not initially primed with flushing fluid.)	Remove suction tube from paint. Prime pump with oil or water-based flushing fluid. See page 14.
	Debris in paint.	Strain the paint. See page 12.
	Thick or "sticky" paint.	Some fluids may prime faster if the ON/OFF switch is momentarily turned off so the pump can slow and stop. Turn ON/OFF switch on and off several times if necessary.
	Inlet strainer is clogged or suction tube is not immersed in paint.	Clean debris off inlet strainer and make sure suction tube is immersed in paint.
	Inlet valve check ball or seat is dirty.	Remove inlet fitting. Clean or replace ball and seat. See page 34.
	Suction tube is leaking.	Inspect suction tube connection for cracks or vacuum leaks.
	Outlet valve check ball is stuck.	Unscrew outlet valve, remove, and clean assembly.
	Prime/Spray Valve is worn or obstructed with debris.	Take sprayer to Graco/MAGNUM authorized service center.



Troubleshooting

Problem	Cause	Solution
Pump is primed, but can not achieve good spray pattern.	Spray tip may be partially clogged.	Clear spray tip clog. See page 21.
	Reversible spray tip is in UNCLOG position.	Rotate arrow-shaped handle on spray tip so it points forward to SPRAY position. See page 21.
	Debris in paint.	Strain the paint. See page 12.
	Pressure is set too low.	Align pressure control knob setting indicator to desired spray setting. See page 19.
	InstaClean fluid filter is clogged.	Clean or replace InstaClean fluid filter. See page 28.
	Spray gun fluid filter is clogged.	Clean or replace gun fluid filter. See page 28.
	Spray tip selected is too large for capability of sprayer.	Replace tip. See page 19.
	Spray tip is worn beyond the capability of sprayer.	Replace tip. See page 19.
	Spray tip gasket and seal worn or missing.	Replace gasket and seal. See page 18.
	Inlet strainer is clogged or suction tube is not immersed in paint.	Clean debris off inlet strainer and make sure suction tube is immersed in paint.
	Extension cord is too long or not heavy enough gauge.	Replace extension cord. See page 5.
	Inlet pump valve or outlet pump valve is worn or clogged with debris.	<p>Check for worn or contaminated inlet valve or outlet valve.</p> <ul style="list-style-type: none"> - Prime sprayer with paint - Trigger gun momentarily - When trigger is released, pump should cycle momentarily and stop - If pump continues to cycle, pump valves may be worn or contaminated with debris - Clean or replace valves with appropriate kits. See page 46.
	Material is too thick.	Thin material. Follow manufacturers recommendations.
Airless hose is too long (if extra section was added).	Remove section of airless hose.	
Spray gun stopped spraying while trigger is pulled.	Spray tip is clogged.	Clear spray tip clog. See page 21.
	Sprayer lost prime.	See troubleshooting section "Sprayer runs, but pump does not prime or loses prime while in use." on page 37.
When paint is sprayed, it runs down the wall or sags.	Material is going on too thick.	Move gun faster.
		Choose a spray tip with smaller hole size.
		Choose spray tip with wider fan.
		Make sure gun is far enough from surface.

Problem	Cause	Solution
When paint is sprayed, coverage is inadequate.	Material is going on too thin.	Move gun slower.
		Choose spray tip with larger hole size.
		Choose spray tip with narrower fan. Make sure gun is close enough to surface.
Fan pattern varies dramatically while spraying.	Pressure control switch is worn and causing excessive pressure variation.	Take sprayer to Graco/MAGNUM authorized service center.
Cannot trigger spray gun.	Spray gun trigger lock is engaged.	Rotate trigger lock to disengage trigger lock. See page 12.
Paint is coming out of pressure control.	Pressure control is worn.	Take sprayer to Graco/MAGNUM authorized service center.
Paint is leaking through drain tube.	Sprayer is over pressurizing.	Take sprayer to Graco/MAGNUM authorized service center.
Paint leaks down outside of pump.	Pump packings are worn.	Replace pump packings with new ProXChange module. See page 33.
Motor is hot and runs intermittently. Motor automatically shuts off due to excessive heat. Damage can occur if cause is not corrected.	Vent holes in enclosure are plugged or sprayer is covered.	Keep vent holes clear of obstructions and overspray and keep sprayer open to air.
	Extension cord is too long or not a heavy enough gauge.	Replace extension cord. See page 5.
	Unregulated electrical generator being used has excessive voltage.	Use electrical generator with a proper voltage regulator.
	Motor needs to be replaced.	Take sprayer to Graco/Magnum authorized retailer, distributor, or service center.

17F924, 17G184, 17H222, 17H223 Hopper

17F924, 17G184, 17H222, 17H223 Hopper Sprayers

Ref.	Torque
	15-20 in-lb (1.5 - 2 N•m)
	30-35 in-lb (3.5 - 4.0 N•m)
	110-120 in-lb (12 - 14 N•m)

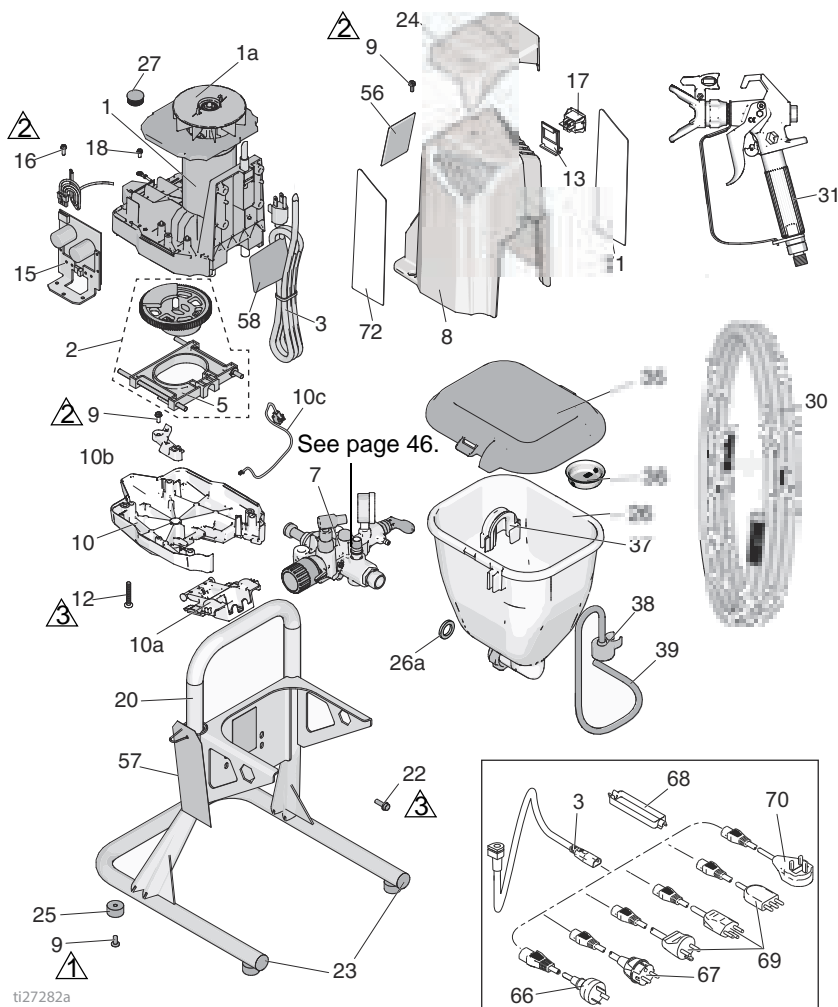

ti27282a

17F924, 17G184, 17H222, 17H223 Hopper

17F924, 17G184, 17H222, 17H223 Hopper Sprayers





Parts List

Ref. Part	Description	Qty.	Ref. Part	Description	Qty.
1*	KIT, motor <i>includes 1a, 22</i>		35 17H417	LID, hopper	1
	17F757 120V, Model 17F924	1	36 112133	SCREEN, hopper	1
	17F758 230V, Models 17G184, 17H222, 17H223	1	37 17H419	CLIP, drain hose	1
1a	16X980 KIT, fan	1	38 244035	DEFLECTOR, barbed	1
2	17J863 KIT, gear and yoke <i>includes 5</i>	1	39 17K336	TUBE, drain <i>includes 37, 38</i>	1
3	CORD, power		56▲	LABEL, warning	
	17J173 Model 17F924	1	17J912	Model 17F924	1
	17J175 Model 17G184	1	16G596	Models 17G184, 17H222	1
	17L301 Model 17H222, 17H223	1	17K016	Model 17H223	1
5	17J864 KIT, yoke	1	57▲	CARD, medical alert (not shown)	
7	17J909 PUMP, displacement	1	222385	EN, ES, FR	1
8	17J887 SHIELD, motor <i>includes 9, 56</i>	1	17A134	EN, ZH, KO	1
9	118444 SCREW, mach, hw hwd 10-24 x 0.5 in.	7	58▲	LABEL, warning, cord	
10	17J866 KIT, cover, front <i>includes 9, 10a, 10b, 10c, 12</i>	1	15H085	Model 17F924	1
10a	17F233 COVER, pump, locking	1	15H087	Model 17H223	1
10b	17F262 COVER, wire	1	66 242005	CORDSET, AU Model 17H223	1
10c	128551 CABLE, PC, jumper	1	67 242001	CORDSET, EU Model 17H222, 17H223	1
12	115478 SCREW, mach, Torx, pan hd	4	68 195551	RETAINER, plug Model 17H222, 17H223	1
13	15X737 SWITCH, bracket	1	69 287121	CORDSET, Italy/Denmark/Sweden Model 17H222	1
15	KIT, control <i>includes 15a, 16</i>		70 17J242	CORDSET, UK Model 17H222	1
	17J867 120V, Model 17F924	1	71	LABEL, left side	
	17J885 230V, Models 17G184, 17H222, 17H223	1	17F947	Models 17F924, 17H223	1
15a	119276 FUSE, 12.5A slow blow, 110V/120V	1	17J041	Models 17G184, 17H222	1
	129882 FUSE, 6.3A, slow blow, 230V	1	72	LABEL, right side	
16	117501 SCREW, plastite	1	17F946	Models 17F924, 17H223	1
17	118899 SWITCH, rocker	1	17J039	Models 17G184, 17H222	1
18	115498 SCREW, mach, slot, hex whd	1			
20	17H426 FRAME, hopper	1			
22	128795 SCREW, hwh, thread forming	4			
23	120151 RETAINER, caplug	2			
24	17H593 COVER, shroud	1			
25	17K640 DAMPENER, feet	4			
26	17J244 ASSEMBLY, hopper <i>includes 26a, 35</i>	1			
26a	115099 WASHER, hose	1			
27	17J819 PLUG	1			
30	214698 HOSE, cpld, 3/16 in. x 25ft	1			
31	17J261 GUN, spray, FTX	1			

*For Motor Brush Kit order 17U193.
 ▲Replacement Danger and Warning labels, tags, and cards are available at no cost.

Pump Assembly

Pump Assembly

Ref.	Torque	Ref.	Torque
 1	140-160 in-lb (16 - 18 N•m)	 4	220-250 in-lb (25 - 28 N•m)
 2	270-330 in-lb (30 - 37 N•m)	 5	320-380 in-lb (36 - 43 N•m)
 3	30-35 ft-lb (40 - 48 N•m)		

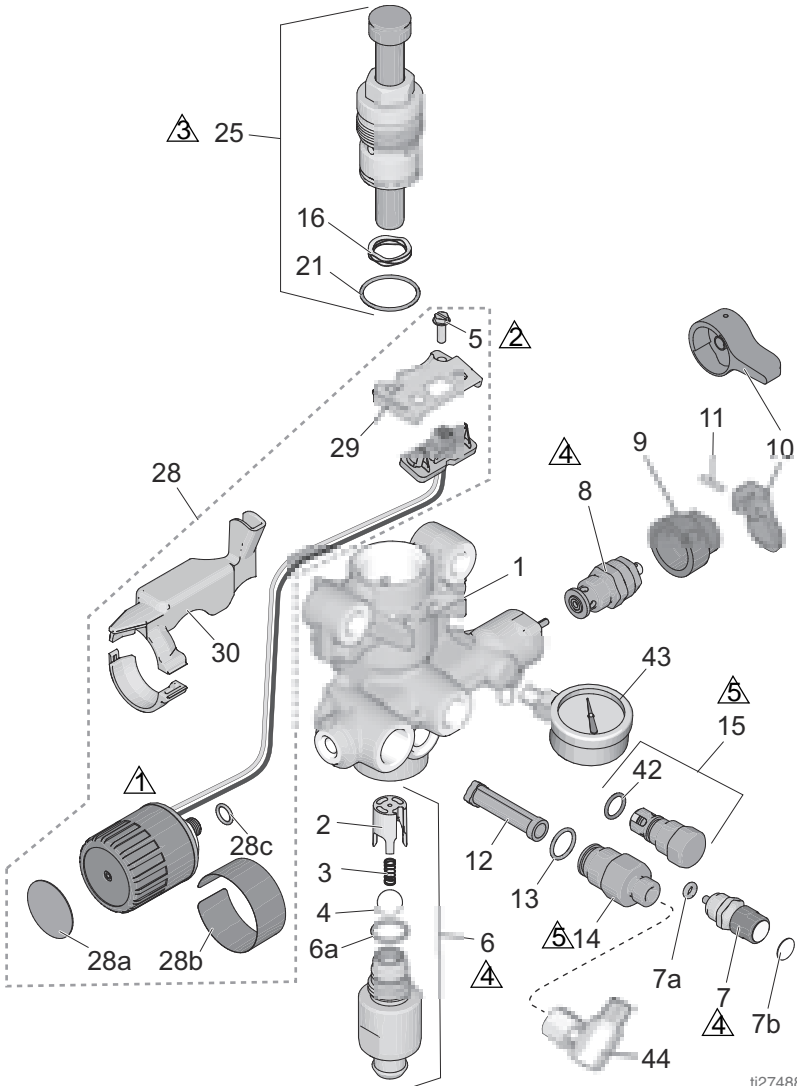

ti27488a

Pump Parts List

Ref. Part	Description	Qty.	Ref. Part	Description	Qty.
1	17G447 HOUSING, pump 17H605 Models 17F924, 17G184, 17H222, 17H223	1	14	24Y327 KIT, repair outlet <i>includes 12, 13</i>	1
2	17D364 GUIDE, ball	1	15	17J880 KIT, outlet valve repair <i>includes 42</i>	1
3	128336 SPRING, compression	1	16	128323 SPRING, valve	1
4	105445 BALL, 0.5 in.	1	21	16D531 PACKING, O-ring	1
5	117501 SCREW, mach, slot HWH	2	25	24Y472 KIT, repair, piston pump <i>includes 16, 21</i>	1
6	KIT, inlet housing <i>includes 2, 3, 4, 6a</i>		28	KIT, pressure control <i>includes 5, 28a, 28b, 28c, 29, 30</i>	
	17J876 Models 24Y680, 17G183, 17H218, 17H219, 17H221	1	17J881 Models 17H211, 17H214		1
	17J877 Models 17H211, 17H214	1	17J927 Models 24Y680, 17F924, 17G183, 17G184, 17H218, 17H219, 17H221, 17H222, 17H223		1
	17J924 Models 17F924, 17G184, 17H222, 17H223	1	28a	15A464 LABEL, control	1
6a	124582 PACKING, O-ring	1	28b	17P739 LABEL, control	1
7	17J878 KIT, PushPrime <i>includes 7a, 7b</i>	1	28c	106555 O-ring	1
7a	16P303 PACKING, O-ring	1	29	17F227 BRACKET, electrical connector	1
7b	17K420 LABEL, PushPrime	1	30	KIT, shield, wire Models 17H211, 17H214	1
8	KIT, valve, drain, <i>includes 9, 10, 11</i>		17F229 Models 17H211, 17H214		1
	235014 Models 17H211, 17H214	1	17J882 Models 24Y680, 17F924, 17G183, 17G184, 17H218, 17H219, 17H221, 17H222, 17H223		1
	17J925 Models 24Y680, 17F924, 17G183, 17G184, 17H218, 17H219, 17H221, 17H222, 17H223	1	42	122486 PACKING, O-ring	1
9	BASE, valve		43	16X147 GAUGE, pressure Models 17F924, 17G184, 17H222, 17H223	1
	224807 Models 17H211, 17H214	1	44	155541 FITTING, swivel Models 17F924, 17G184, 17H222, 17H223	1
10	HANDLE, valve, drain				
	187625 Models 17H211, 17H214	1			
	15Y185 Models 24Y680, 17F924, 17G183, 17G184, 17H218, 17H219, 17H221, 17H222, 17H223 <i>includes 11</i>	1			
11	111600 PIN, grooved Models 17H211, 17H214	1			
12	288747 KIT, filter (Not installed on all models.)	1			
13	120776 PACKING, O-ring	1			

Wiring Diagrams

110/120V

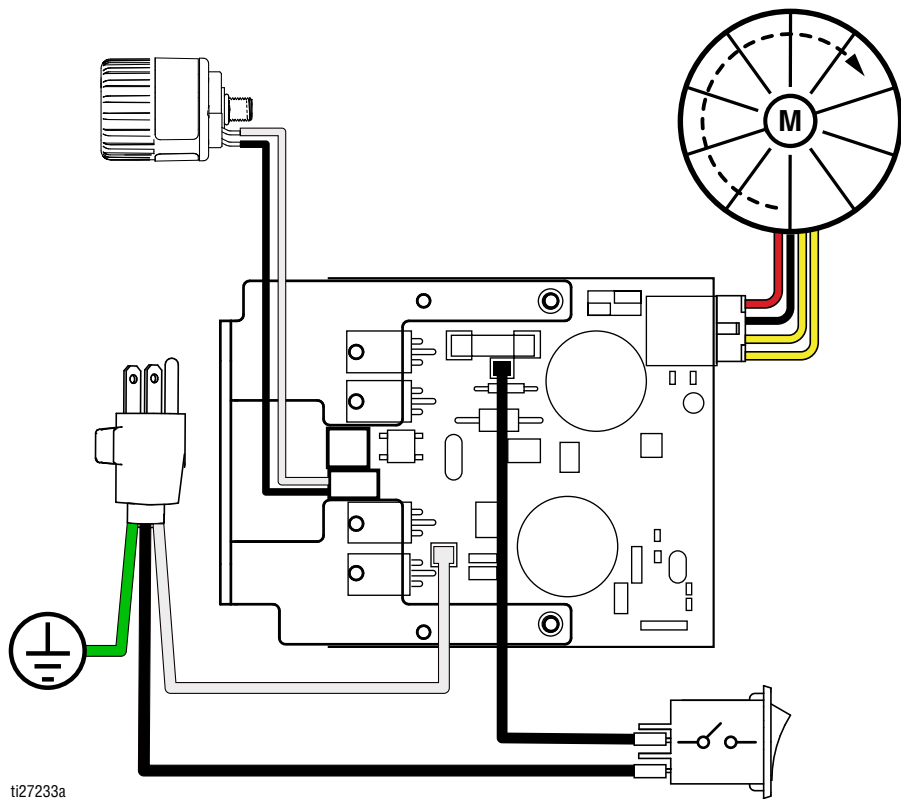

230V

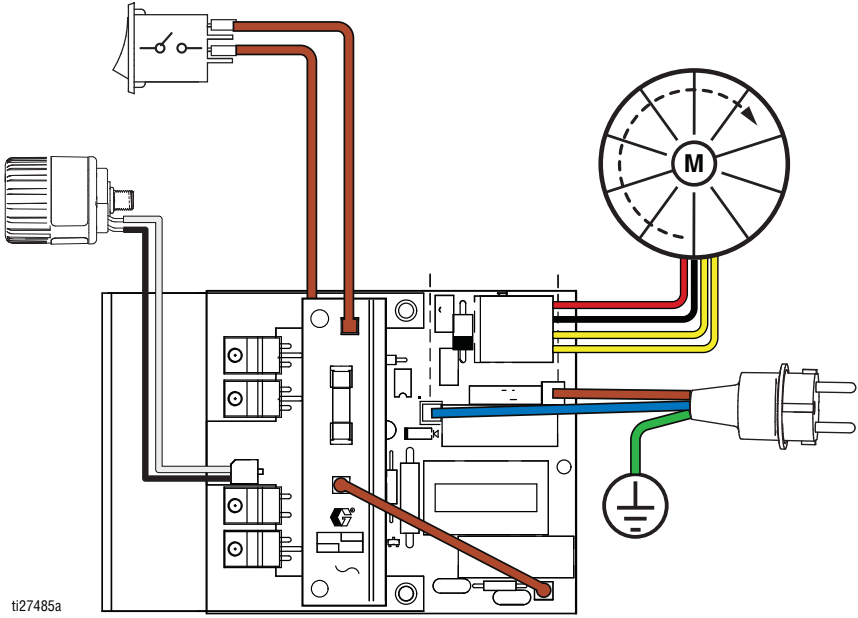

Technical Specifications

Technical Specifications

GX 19, GX 21, FinishPro GX 19

GX 19, GX 21, FinishPro GX 19		
	US	Metric
Sprayer		
Maximum fluid working pressure	3000 psi	207 bar, 20.7 MPa
Maximum Delivery		
GX 19/FinishPro GX 19	0.38 gpm	1.4 lpm
GX 21	0.47 gpm	1.8 lpm
Maximum Tip Size		
GX 19/FinishPro GX 19	0.019 in.	0.048 mm
GX 21	0.021 in.	0.053 mm
Fluid Outlet npsm	1/4 in.	1/4 in.
Generator Minimum	3500 W	
Power Requirements		
GX 19	110–120V, 8 A / 220–240V, 5 A	
GX 21	110–120V, 12 A / 220–240V, 10 A	
Dimensions		
Height		
Stand	18.4 in.	46.7 cm
DI Stand	22 in.	55.9 cm
Hopper	19.6 in.	49.8 cm
Length		
Stand	16.7 in.	47.5 cm
DI Stand	18.4 in.	46.7 cm
Hopper	20.2 in.	51.3 cm
Width		
Stand	13.5 in.	34.3 cm
DI Stand	12 in.	30.5 cm
Hopper	13.5 in.	34.3 cm
Weight		
Stand	25 lb.	11.3 kg
DI Stand	29 lb.	13.2 kg
Hopper	28 lb.	12.1 kg
Storage temperature range ♦❖	–30° to 160°F	–35° to 71°C
Operating temperature range ✓	40° to 115°F	4° to 46°C

Technical Specifications

GX 19, GX 21, FinishPro GX 19		
	US	Metric
Noise**		
Sound pressure	83 dBa*	
Sound power	93 dBa*	
Materials of Construction		
Wetted materials on all models	stainless steel, brass, leather, ultra-high molecular weight polyethylene (UHMWPE), carbide, nylon, aluminum, PVC, polypropylene, fluoroelastomer	
Notes		
* Startup pressures and displacement per cycle may vary based on suction condition, discharge head, air pressure, and fluid type.		
** Sound pressure measured 3 feet (1 meter) from equipment. Sound power measured per ISO-9614.		
<p>◆ When pump is stored with non-freezing fluid. Pump damage will occur if water or latex paint freezes in pump.</p>		
❖ Damage to plastic parts may result if impact occurs in low temperature conditions.		
✓ Changes in paint viscosity at very low or very high temperatures can affect sprayer performance.		

Technical Specifications

GX FF

GX FF		
	US	Metric
Sprayer		
Maximum fluid working pressure	3000 psi	207 bar, 20.7 MPa
Maximum Delivery	0.38 gpm	1.4 lpm
Maximum Tip Size	0.019 in.	0.048 mm
Fluid Outlet npsm	1/4 in.	1/4 in.
Generator Minimum	1500 W	
Power Requirements	110–120V, 8 A / 220–240V, 5 A, 1Ø	
Dimensions		
Height	19.6 in.	49.8 cm
Length	20.2 in.	51.3 cm
Width	13.5 in.	34.3 cm
Weight	31 lb.	14.1 kg
Storage temperature range ♦❖	–30° to 160°F	–35° to 71°C
Operating temperature range ✓	40° to 115°F	4° to 46°C
Noise**		
Sound pressure	83 dBa*	
Sound power	93 dBa*	
Materials of Construction		
Wetted materials on all models	stainless steel, brass, leather, ultra-high molecular weight polyethylene (UHMWPE), carbide, nylon, aluminum, PVC, polypropylene, fluoroelastomer	
Notes		
* Startup pressures and displacement per cycle may vary based on suction condition, discharge head, air pressure, and fluid type.		
** Sound pressure measured 3 feet (1 meter) from equipment. Sound power measured per ISO-9614.		
♦ When pump is stored with non-freezing fluid. Pump damage will occur if water or latex paint freezes in pump.		
❖ Damage to plastic parts may result if impact occurs in low temperature conditions.		
✓ Changes in paint viscosity at very low or very high temperatures can affect sprayer performance.		

Graco Standard Warranty

Graco warrants all equipment referenced in this document which is manufactured by Graco and bearing its name to be free from defects in material and workmanship on the date of sale to the original purchaser for use. With the exception of any special, extended, or limited warranty published by Graco, Graco will, for a period of twelve months from the date of sale, repair or replace any part of the equipment determined by Graco to be defective. This warranty applies only when the equipment is installed, operated and maintained in accordance with Graco's written recommendations.

This warranty does not cover, and Graco shall not be liable for general wear and tear, or any malfunction, damage or wear caused by faulty installation, misapplication, abrasion, corrosion, inadequate or improper maintenance, negligence, accident, tampering, or substitution of non-Graco component parts. Nor shall Graco be liable for malfunction, damage or wear caused by the incompatibility of Graco equipment with structures, accessories, equipment or materials not supplied by Graco, or the improper design, manufacture, installation, operation or maintenance of structures, accessories, equipment or materials not supplied by Graco.

This warranty is conditioned upon the prepaid return of the equipment claimed to be defective to an authorized Graco distributor for verification of the claimed defect. If the claimed defect is verified, Graco will repair or replace free of charge any defective parts. The equipment will be returned to the original purchaser transportation prepaid. If inspection of the equipment does not disclose any defect in material or workmanship, repairs will be made at a reasonable charge, which charges may include the costs of parts, labor, and transportation.

THIS WARRANTY IS EXCLUSIVE, AND IS IN LIEU OF ANY OTHER WARRANTIES, EXPRESS OR IMPLIED, INCLUDING BUT NOT LIMITED TO WARRANTY OF MERCHANTABILITY OR WARRANTY OF FITNESS FOR A PARTICULAR PURPOSE.

Graco's sole obligation and buyer's sole remedy for any breach of warranty shall be as set forth above. The buyer agrees that no other remedy (including, but not limited to, incidental or consequential damages for lost profits, lost sales, injury to person or property, or any other incidental or consequential loss) shall be available. Any action for breach of warranty must be brought within two (2) years of the date of sale.

GRACO MAKES NO WARRANTY, AND DISCLAIMS ALL IMPLIED WARRANTIES OF MERCHANTABILITY AND FITNESS FOR A PARTICULAR PURPOSE, IN CONNECTION WITH ACCESSORIES, EQUIPMENT, MATERIALS OR COMPONENTS SOLD BUT NOT MANUFACTURED BY GRACO. These items sold, but not manufactured by Graco (such as electric motors, switches, hose, etc.), are subject to the warranty, if any, of their manufacturer. Graco will provide purchaser with reasonable assistance in making any claim for breach of these warranties.

In no event will Graco be liable for indirect, incidental, special or consequential damages resulting from Graco supplying equipment hereunder, or the furnishing, performance, or use of any products or other goods sold hereto, whether due to a breach of contract, breach of warranty, the negligence of Graco, or otherwise.

FOR GRACO CANADA CUSTOMERS

The Parties acknowledge that they have required that the present document, as well as all documents, notices and legal proceedings entered into, given or instituted pursuant hereto or relating directly or indirectly hereto, be drawn up in English. Les parties reconnaissent avoir convenu que la rédaction du présente document sera en Anglais, ainsi que tous documents, avis et procédures judiciaires exécutés, donnés ou intentés, à la suite de ou en rapport, directement ou indirectement, avec les procédures concernées.