



Instructions for use and assembly instructions

Hänchen products



HÄNCHEN®



Hydraulikzylinder
Hydraulic cylinder



**Klemmeinheit
Ratio-Clamp®**
Clamping device
Ratio-Clamp®



Druckübersetzer
Pressure intensifier



**Schwingungs- und
Körperschalldämpfer**
Vibration and
structure-borne sound
absorber

Instructions for use and assembly instructions

Hänchen products

EN

1 User guidance 34

1.1 Target group	34
1.2 Structure of instructions for use and assembly instructions	34
1.2.1 Warning notices	34
1.2.2 Tips, notes, recommendations	34
1.2.3 Operating instructions	35
1.3 Applicable documents	35
1.4 Storage	35
1.5 Symbols on the product	35

2 Safety instructions 36

2.1 Regulations	36
2.2 Personal protective equipment	36
2.3 Inspection and testing	37

3 Intended use 37

3.1 Hydraulic cylinders and pressure intensifiers	37
3.1.1 Intended use	37
3.1.2 Improper use	37
3.2 Clamping device Ratio-Clamp®	37
3.2.1 Intended use	37
3.2.2 Improper use	38
3.3 Vibration and structure-borne sound absorbers	38
3.3.1 Intended use	38
3.3.2 Improper use	38

4 Function 38

4.1 Hydraulic cylinders and pressure intensifiers	38
4.2 Clamping device Ratio-Clamp®	38
4.3 Vibration and structure-borne sound absorber	38

5 Operation 38

5.1 Hydraulic cylinders and pressure intensifier	39
5.2 Clamping device Ratio-Clamp®	41

6 Assembly 42

6.1 Transport	43
6.2 Storage	44

6.3 Scope of delivery	44
6.4 Installation of hydraulic cylinders and pressure intensifiers	44
6.4.1 Venting	46
6.4.2 Flushing of the pipes	48
6.4.3 Installation of accessories	48
6.4.4 Cushioning	49
6.4.5 Proximity switch	50
6.5 Installation of clamping device Ratio-Clamp®	50
6.5.1 Installation and venting	50
6.5.2 Flushing of the pipes	51
6.5.3 Activation	51
6.5.4 Proximity switch	51
6.5.5 Installation	53
6.6 Installation of vibration and structure-borne sound absorber	54

7 Start-up 54

7.1 Start-up of hydraulic cylinders and pressure intensifiers	55
7.1.1 Additional information on start-up of hydraulic cylinder sealing system Servofloat®	55
7.1.2 Additional information on start-up on hydraulic cylinder guiding system Servobear®	55
7.2 Start-up of clamping device Ratio-Clamp®	56
7.3 Start-up of vibration and structure-borne sound absorber	56

8 Removal from service 56

8.1 Disassembly	56
8.2 Disposal	57

9 Maintenance 57

9.1 Hydraulic cylinders and pressure intensifier	57
9.2 Clamping device Ratio-Clamp®	57
9.3 Vibration and structure-borne sound absorber	58

10 Technical data 58

1 User guidance

The instructions for use and assembly instructions contain all important information on the assembly, start-up and operation of Hänchen products.

The term Hänchen products comprises hydraulic cylinders, pressure intensifiers, clamping devices Ratio-Clamp® and vibration and structure-borne sound absorbers. Read the instructions for use and assembly instructions thoroughly and completely, and only use the product when you are sure you have understood the instructions for use and assembly instructions.

If you have any questions, contact our service. You can also find the current service contacts on the Hänchen website: www.haenchen-hydraulic.com

1.1 Target group

These instructions for use and assembly instructions address trained specialized personnel and certified hydraulic specialists. The contents of these instructions for use and assembly instructions must be made available to all persons who install or operate Hänchen products.

1.2 Structure of instructions for use and assembly instructions

1.2.1 Warning notices

Structure of warning notices

Warning notices are structured as follows:

▲ SIGNAL WORD!	<ul style="list-style-type: none"> • Type and source of danger! • Consequences in case of non-observance • → Measure to avoid the danger
-----------------------	---

Classification of warning notices

Depending on the type of danger, warning notices are classified as follows:

Signal word panel	Type of danger
▲ DANGER!	Indicates an immediate risk which, if not avoided, will result in death or serious injury.
▲ WARNING!	Indicates a potentially hazardous situation which, if not avoided, will result in death or serious injury.
▲ CAUTION!	Indicates a potentially hazardous situation which, if not avoided, will result in minor or moderate injury.
NOTICE	Indicates a potentially hazardous situation which, if not avoided, will result in material or environmental damage.

Table 1: Danger classes according to ANSI Z535.6

1.2.2 Tips, notes, recommendations

 Provides the user with useful tips, notes or recommendations for efficient use of the product.

1.2.3 Operating instructions

Instructions prompt you to perform an action or workstep. Always perform the required actions one after the other and in the specified order.

Instructions are structured as follows:

→ Instruction to perform an action by the machine manufacturer or operator.
Indication of a result, if necessary.

1.3 Applicable documents

For safe and correct use of the product, observe also any other documents provided (e.g. delivery documents, drawings, design documents) and the applicable standards and laws.

1.4 Storage

Always keep the instructions for use and assembly instructions available near the system. This includes any other applicable documents.

1.5 Symbols on the product

The following health and safety signs are found on the product:

Type plate indicating maximum admissible pressure

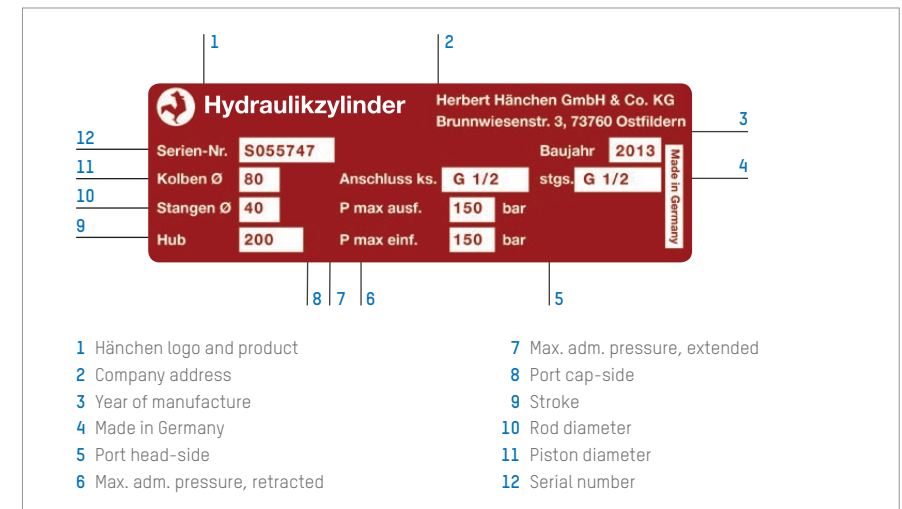

Figure 1: e.g. Type plate of hydraulic cylinder

The type plates of pressure intensifiers, clamping devices Ratio-Clamp® and vibration and structure-borne sound absorbers also contain the information specific to the product.



2 Safety instructions

▲ DANGER!

Danger to life due to defective system!

- Make sure that defects of Hänchen products or their components do not create any danger for persons or objects.
- If a Hänchen product or one of its components does not work properly:
 - Put Hänchen product out of operation immediately.
 - Protect Hänchen product against unauthorized use.

▲ DANGER!

Danger to life due to incorrect use!

- Use Hänchen product exclusively for its intended purpose.
- Use Hänchen product exclusively in its original condition, and in flawless working order.

▲ DANGER!

Danger to life due to limited perception!

- Make sure that persons working on or with the Hänchen product
 - are not under the influence of alcohol or drugs.
 - are not physically or mentally handicapped.

2.1 Regulations

▲ DANGER!

Danger to life due to non-observance of instructions!

- Observe the safety instructions, requirements and measures of the following standards:
- EN ISO 12100
 - EN ISO 4413

- Selecting and installing a Ratio-Clamp® clamping device:
 - according to the information in this instructions for use and assembly instructions.
 - according to the requirements of the product standards applicable to the machines in which the clamping device will be installed.

If the clamping device will be used as a security element, the company Hänchen must design it for the specific application case.

2.2 Personal protective equipment

▲ DANGER!

Danger to life due to not using personal protective equipment!

- For all work on Hänchen products or hydraulic systems using Hänchen products:
- Wear personal protective equipment.

The personal protective equipment comprises:

- protective gloves
- safety helmet
- safety shoes
- protective goggles

2.3 Inspection and testing

▲ DANGER!

Danger to life due to insufficient checking or undetected faults or damage!

- Check the hydraulic system in which the Hänchen is installed at regular intervals suitable to the operation conditions.
- Make sure that the hydraulic system and its component parts match the system description.
- Make sure that the connections between the component parts in the hydraulic system match the schematic diagram.
- Make sure that the hydraulic system, including all safety component parts, is working properly.
- Make sure that there is no detectable, inadvertent leaking when the hydraulic system is pressurized either with the maximum working pressure or the pressure indicated by the manufacturer. The admissible leaking is an amount of liquid that is not enough to form a drop.

3 Intended use

3.1 Hydraulic cylinders and pressure intensifiers

3.1.1 Intended use

- Use hydraulic cylinders exclusively to generate a linear movement by means of hydraulic energy.
- Use pressure intensifiers exclusively to generate a secondary pressure by means of hydraulic energy.
- Always install hydraulic cylinders and pressure intensifiers in machines or partly completed machines according to Machinery Directive 2006/42/EC.
- Use hydraulic cylinders and pressure intensifiers exclusively within the prescribed limits.
- Observe directions on the documentation applicable to the product.

3.1.2 Improper use

- Do not use hydraulic cylinders:
 - as construction elements, e.g. as guiding elements
 - with rotating piston rods

Exception: The product documentation expressly permits the application in question.

3.2 Clamping device Ratio-Clamp®

3.2.1 Intended use

- Use clamping device Ratio-Clamp® exclusively for clamping or holding rods that are standing still.
- Use clamping device Ratio-Clamp® exclusively for purely translatory rod movements according to the respective specification.
- Always install clamping devices Ratio-Clamp® in machines or partly completed machines according to Machinery Directive 2006/42/EC.
- Use clamping device Ratio-Clamp® exclusively within the specified limits.
- Observe directions on the documentation applicable for the product.

i It is possible to install clamping devices Ratio-Clamp® on hydraulic cylinders, or operate them as separate component parts.



3.2.2 Improper use

- Do not use clamping device Ratio-Clamp®:
- for clamping directly from the movement.
 - for clamping rotating rod or shafts.
 - to perform an emergency stop function as a brake.

3.3 Vibration and structure-borne sound absorbers

3.3.1 Intended use

- Use vibration and structure-borne sound absorbers exclusively for absorbing vibrations and structure-borne sound.

3.3.2 Improper use

- Do not use vibration and structure-borne sound absorbers:
- for absorbing switching or acceleration jolts in hydraulic systems.
 - for absorbing vibrations caused by vibrating non-return valves, undamped pressure-limiting valves, etc.
 - for storing hydraulic energy.

4 Function

4.1 Hydraulic cylinders and pressure intensifiers

Various types of hydraulic cylinders are used to generate linear movements using hydraulic energy. The hydraulic cylinders are intended exclusively for industrial applications and must be installed in or attached to complete or partly completed machines or equipment.

Pressure intensifiers generate a secondary pressure inside a pressure chamber, which is pressurized by the extending piston rod of a hydraulic cylinder. The area ratio determines the pressure increase factor.

4.2 Clamping device Ratio-Clamp®

The clamping device Ratio-Clamp® uses the principle of frictional contact. Clamping devices with springs use the energy stored in the springs, which is redirected and used for clamping. Clamping devices without spring elements use hydraulic energy, which is redirected and used for clamping. The clamping device is released by pressurizing it with hydraulic pressure at the releasing port.

4.3 Vibration and structure-borne sound absorber

Vibration and structure-borne sound absorbers reduce vibrations of the oil column in the hydraulic system. The oil coming out of the vibration and structure-borne sound absorber flows at a low pulsation.

5 Operation

▲ DANGER!

Danger to life due to defective product!

- Make sure that defects on Hänchen products or their components do not create any danger for persons or objects.
- If Hänchen product or one of its components is not working correctly:
- Put Hänchen product out of operation immediately.
- Protect Hänchen product against unauthorized use.

▲ DANGER!

Danger to life due to movement of hydraulic cylinder!

- Make sure that the mechanical movement of the hydraulic cylinder (e.g. extending the piston rod), intentional or unintentional, will not lead to situations that put persons at risk.
- Take into account the effects of acceleration, braking, or lifting/holding masses.

▲ DANGER!

Danger to life due to high pressure!

- Make sure that the operating temperature does not exceed the limit values prescribed for the hydraulic systems and all component parts.
- Operate hydraulic systems exclusively with completely connected hydraulic and electric lines.
- Check hydraulic supply lines and pipe connections at regular intervals suitable to the operating conditions.
- Replace damaged pipe connections.

▲ CAUTION!

Danger of burns due to hot surfaces!

- Touch surfaces of hydraulic cylinders exclusively with protective gloves.

NOTICE

Damage as a result of high side loads in the case of long strokes when installed horizontally or diagonally!

- Install the cylinder gravity supported.

5.1 Hydraulic cylinders and pressure intensifier

- Note the following conditions in operation of the hydraulic system in which the hydraulic cylinders or pressure intensifiers are used.

Operating conditions

- If not specified otherwise, observe the following operating conditions:
- operation with hydraulic oils according to DIN 51524 with ISO VG 32 to VG 68
 - use in temperate climate zones
 - use in roofed spaces
 - relative air humidity < 70%
 - ambient temperature -15 °C to +80 °C
 - operating temperatures for sealing elements: -15 °C to +80 °C

When using other liquids (e.g. water, water emulsions, fire-resistant fluids or others), or if a different ambient or operating temperature is to be expected:

- Consult Hänchen on the use of the hydraulic cylinders or pressure intensifiers under changed operating conditions.

Recommended cleanliness classes according to ISO 4406:

- for hydraulic cylinders or pressure intensifiers with normal sealing elements (actuators with lip seal and wiper ring): cleanliness class 19/16/13.
- for hydraulic cylinders or pressure intensifiers with gap seals, e.g. Servofloat® or Servobear®: cleanliness class 16/13/10.



i Hänchen recommends rinsing the system and filtering the medium prior to the actual start-up.

Potential danger points

- If possible, take suitable constructive measures to prevent burns.
- As the operator, install permanent guards, constructive if possible, to secure any spots that pose crushing or trapping hazards.
- Use wire mesh guards to secure danger areas.
- Install guards in accordance with the requirements of EN 953.

Unexpected start

- Use suitable hardware for circuitry-wise prevention of malfunctions or unexpected starts in case of faults of the control system.
- Ensure controlled restart in case of defective output of system control.
- Make sure that system control switches to basic position until it is released in case of an unexpected start.

Uncontrolled movement, jammed piston rod

- Take suitable measures to prevent uncontrolled, jerky movements or jamming of the piston rod in case of a defect of the control system.
- Take suitable measures to prevent uncontrolled movements or faulty feedback in case the control line of a sensor or a valve breaks.
- Make sure that all outputs are de-energized in case of a power failure.

Emergency stop

- Take suitable measures in the emergency switch-off or emergency stop system of the hydraulic system to prevent dangers caused by the hydraulic cylinder.

Pressure resistance

- Design all parts of the hydraulic system and the hydraulic cylinder or pressure intensifier for pressures
 - higher than the maximum working pressure of the hydraulic system or a component part.
 - exceeding the rated pressure of the hydraulic system or a component part.
- Make sure that pressure surges and pressure fluctuations do not cause any dangers.

Pressure loss

- Make sure that pressure loss or critical pressure drops do not cause any risks for persons or damage to the machine.

Pressure fluctuations

- Take suitable measures to prevent pressure fluctuations that lead to the rated pressures being exceeded.

Fixation

- Design mounting elements for hydraulic cylinders or pressure intensifiers in such a way that
 - excessive deformation of hydraulic cylinders or pressure intensifiers by tensile and compressive loads is minimised.
 - the application of side or bending loads is minimised.
 - the side loads acting on the piston rod do not exceed the indicated admissible limits.
 - the load is acting axially on the axis of the cylinder's piston rod.
- Design mounting faces so as to prevent any twisting of the installed hydraulic cylinder or pressure intensifier.
- Design and install mounting screws for hydraulic cylinders or pressure intensifiers and accessories in such a way that they absorb all foreseeable forces.
- Make sure that mounting screws absorb the tilting moments.

- Take into account the maximum expected loads and pressure peaks.
- When using a hydraulic cylinder or a pressure intensifier as an end stop, design the mounting elements in such a way that all occurring loads are absorbed without causing any damage.
- Use mounting faces to prevent twisting the hydraulic cylinder or pressure intensifier.
- Take into account potential expansion caused by pressure and temperature.
- For pivoted installation requiring constant external lubrication: Minimize pivoting speeds.

Accessories, end stops

- Fix all component parts installed on or connected to the hydraulic cylinder or pressure intensifier in such a way that it is not possible for the component parts to become loose due to shocks or vibrations during operation.
- Take constructive measures that prevent adjustable external or internal stroke end stops from becoming loose.

When using internal cushioning:

- Take into account effects of mass retardation for rating and operation.

Buckling strength

- Ensure buckling safety of the hydraulic cylinder for every stroke position.

Accessibility

- Make sure that hydraulic cylinders or pressure intensifiers and accessories are easily accessible for maintenance and adjustment, and that safe maintenance and adjustment are possible.
- Allow for adjustment of cushioning devices and complete replacement of hydraulic cylinders or pressure intensifiers.

Wear, corrosion, damage

- Protect piston rods against foreseeable damage (e.g. nicks, scratches, corrosion).

Sound emission

- Take suitable measures to minimize sound emission.
- Take into account airborne, structure-borne and fluid-borne sound.

5.2 Clamping device Ratio-Clamp®

- Operation of the hydraulic system in which the Ratio-Clamp® is used, note the conditions given in section 5.1:
 - Unexpected start
 - Uncontrolled movement, jammed piston rod
 - Emergency switch off
 - Pressure resistance
 - Pressure loss
 - Pressure fluctuations
 - Fixation
 - Accessibility

Operating conditions

- If not otherwise specified, observe the following operating conditions:
 - operation with hydraulic oils according to DIN 51524 with ISO VG 32 to VG 68
 - use in temperate climate zones
 - use in roofed spaces
 - relative air humidity < 70%



- ambient temperature -30 °C to +80 °C
- operating temperatures for sealing elements: -30 °C to +80 °C

When using other liquids (e.g. water, water emulsions, fire-resistant fluids), or a different ambient or operating temperature is to be expected:

→ Consult Hänchen on the use of the clamping device Ratio-Clamp® under changed operating conditions.

Recommended cleanliness classes according to ISO 4406:

→ for clamping device Ratio-Clamp® with normal sealing elements: cleanliness class 19/16/13.

i Hänchen recommends rinsing the system and filtering the medium prior to the actual start-up.

Potential danger points

- As the operator, install permanent guards, constructive if possible, to secure any spots that pose crushing or trapping hazards.
- Install guards in accordance with the requirements of EN ISO 14120.

When using the Ratio-Clamp® clamping device as a restraining device to prevent a hazardous movement in accordance with ISO 13849-1 it is possible that in the event of an error that the clamped rod can sink under its own weight:

- Use the clamping device as redundant element, e.g. to a lock valve.
- Take measures to prevent the Ratio-Clamp® clamping device from unlocking before holding the load.

Limit values

- Observe the following limit values and tolerances according to the specification or product documentation:
 - max. admissible axial load (holding load)
 - admissible pressures
 - properties of the rod to be clamped
- Adjust driving power to match holding load of clamping device Ratio-Clamp®.

6 Assembly

▲ DANGER!

Danger to life due to incorrect installation!

- Make sure that the installation is carried out correctly and exclusively by trained specialised personnel or certified hydraulic specialists.

▲ DANGER!

Danger to life due to high pressure!

- Open screw connections and hydraulic lines exclusively at zero pressure.

6.1 Transport

NOTICE

Material damage due to incorrect transport!

- Transport Hänchen products in their original packaging.
- Mark lines and line connections clearly.
- Close unprotected openings (e.g. ports) for transport.
- Protect male threads during transport.
- Protect functional surfaces (e.g. valve installation surfaces) during transport.

Transport with lifting gear

▲ DANGER!

Danger to life caused by transport eyebolt breaking due to overload!

- Make sure that lifting the Hänchen product by its transport eyebolts is carried out correctly and exclusively by trained specialised personnel or certified hydraulic specialists.

NOTICE

Material damage when lifting due to application of force on attachments (connecting plates, piping etc.) caused by hoisting slings!

- Fix lifting gear (hoisting chains, hoisting slings) on Hänchen products in such a way that the hoisting slings are clear when lifting, i.e. not touching any attachments.

Lifting by transport eyebolts on hydraulic cylinder:

- Fix suitable transport eyebolts to covers in puller thread (axial) or transport thread (radial).
- If necessary, use oil ports for transport screw.
- Fix suitable lifting gear (hoisting chains, hoisting slings) to transport eyebolts in Hänchen product.

Lifting with hoisting slings if no transport eyebolts are available:

- Fix two hoisting slings of the same length to both ends of the cylinder tube of the hydraulic cylinder using loops.
- Observe admissible carrying capacity of hoisting slings.
- Make sure that cylinder is not lifted by attached components such as mounting plate, oil pipes or sensors.

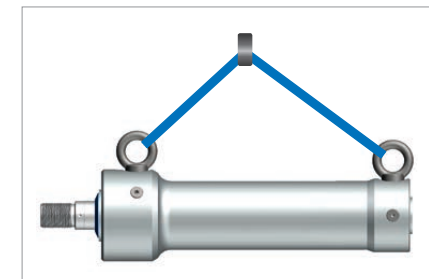

Figure 2: Using transport eyebolts

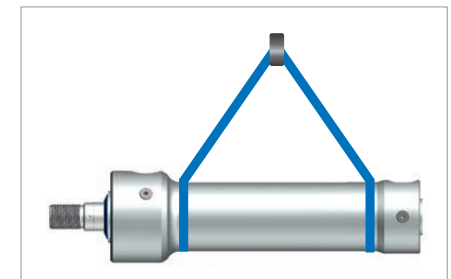

Figure 3: Using hoisting slings



6.2 Storage

To protect the sliding surfaces against corrosion when storing hydraulic cylinders and pressure intensifiers for longer periods of time:

- Fill cylinders with a suitable interior preservative agent.
- Make sure that there is no air in the cylinder.
- Seal ports airtight.

Before start-up:

- Remove preservative agent completely.
- Make sure that sealing elements are not sticking together with preservative agent.

Factory-provided corrosion protection

Hänchen products come with a primer coating (colour: white aluminium RAL 9006) by default.

The following surfaces of hydraulic cylinders and accessories come unpainted and uncoated:

- all fitting diameters and contact surfaces on the customer side
- seal faces for line connection
- seal face for flange connection
- valve installation surface
- inductive proximity switches
- position transducer
- measuring coupling
- spherical bearing/pivot bearing
- lubricating nipple

Uncoated surfaces are protected with corrosion oil.

The basic coating is sufficient for exterior preservation for short storage periods in dry rooms and at constant temperatures.

Interior preservation

If not otherwise specified, Hänchen products are tested with mineral oils according to DIN 51524 Part 2 by default. The oil film remaining on the inside after testing serves as a short-term interior corrosion protection.

6.3 Scope of delivery

Before installation:

- Verify that delivery is complete and undamaged.

The scope of delivery includes the Hänchen product as ordered by the customer according to the order specifications and confirmed in the order confirmation.

- Before the installation, remove any sealing plugs or covering plates that have been applied to protect the product against dirt during the transport.

6.4 Installation of hydraulic cylinders and pressure intensifiers

⚠ CAUTION!

Danger of injury due to sharp edges and corners!

- Wear personal protective equipment for all assembly work.

⚠ CAUTION!

Danger of burns due to hot surfaces!

- Touch surfaces of hydraulic cylinders or pressure intensifiers exclusively with protective gloves.

NOTICE

Damage to piston rod guide, piston rod and in the cylinder tube!

During installation and operation:

- Make sure that admissible side loads on the piston rod are not exceeded.

NOTICE

Material damage due to insufficient venting!

- For correct and easy venting, install hydraulic cylinder in such a way that the venting ports are on top.
- Make sure that air outlet openings of cylinders with air-filled chambers are arranged so as to prevent any risks.
- Make sure that trapped air escapes without causing any danger.

Cylinders with inflexible mounting, such as side lugs mounting:

- Make sure that cylinders are not twisted during installation.

Long cylinders:

- Allow for heat and expansion joints on mounting elements.

Cylinders with flexible mounting:

- Make sure that there is sufficient room between spherical rod eye and clevis, clevis bracket, etc. for pivoting and tilting.

When holding piston rod in place:

- Avoid damage to rod surface.
- Preferably use round-pin hook wrenches according to DIN 1810 or open-ended spanners.

i If not otherwise specified in drawings, the pressure ports are designed for standard screw connections according to DIN 3852 – Part 2, type A and B.

i Hänchen recommends using threaded stud ends with soft sealing.

- Use cylinder screws with a minimum strength of 10.9 for mounting the cylinder and its accessories.
- Observe torques according to VDI 2230 for friction coefficient $\mu = 0.14$.

Screw thread	Torque M_A	Screw thread	Torque M_A
M5	9.5 Nm	M12	137 Nm
M6	16.5 Nm	M16	338 Nm
M8	40 Nm	M20	661 Nm
M10	79 Nm	M24	1136 Nm

Table 2: Torque according to VDI 2230 with minimum strength 10.9



6.4.1 Venting

- ① Hydraulic cylinders and pressure intensifiers are usually supplied with venting screws on both sides. The venting holes are compatible with ports for measuring couplings. Measuring coupling permits clean and easy venting using hoses.



Figure 4: Marking venting port to the product

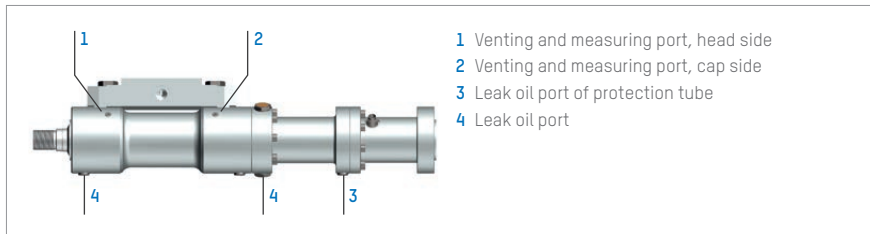

Figure 5: Venting and measuring port of cylinder sealing system Servofloat® or Servoseal®

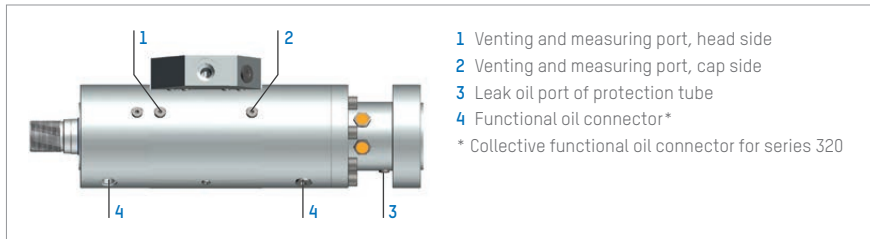

Figure 6: Venting and measuring port of cylinder sealing system Servofloat®

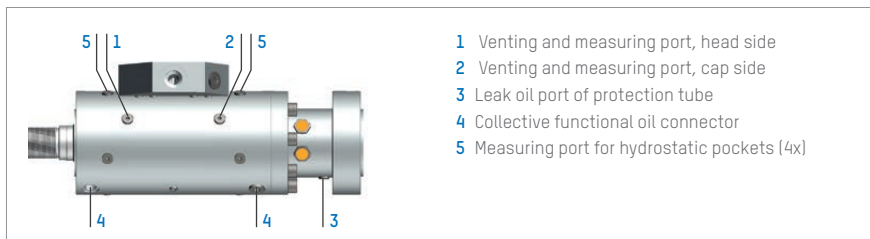

Figure 7: Venting and measuring port of cylinder sealing system Servobear®

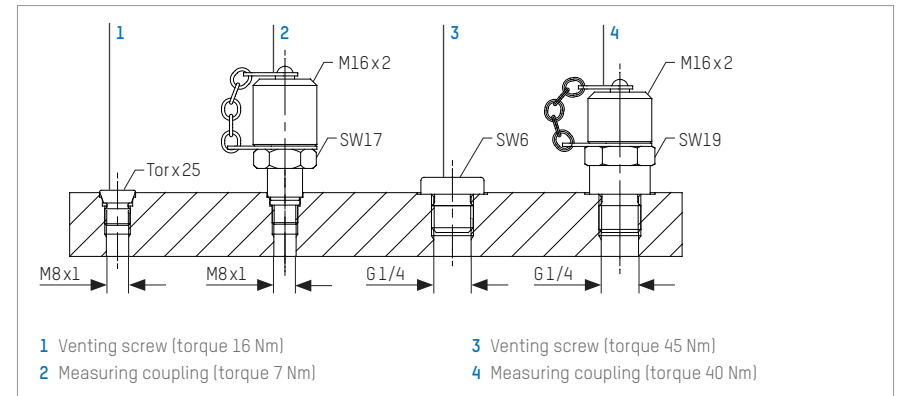

Figure 8: Venting port torques

- Before start-up, vent hydraulic cylinders or pressure intensifiers using a Hänchen venting set.

- ① The venting set is available as equipment.

Venting without Hänchen venting set

Free air inside a hydraulic cylinder will affect the physical properties of the hydraulic oil and has various other negative effects on the component parts, the operating behaviour and the fluid.

Vent without Hänchen venting set as follows:

- Make sure that venting screws are located at highest point of cylinder.
- Make sure that cylinder space in question is under low pressure (approx. 20 bar to 50 bar).
- Open venting screw by approx. one or two turns.

⚠ DANGER!

Danger to life due to fluids under pressure!

- Make sure that adjusting screw is not unscrewed too far.

- ① The venting screw is designed in a such a way that it allows air and oil to escape without having to remove it completely.

When the oil escaping from the gap is bubble-free:

- Re-tighten screw.
- Observe torque.

If there is still air in the cylinder:

- Repeat venting process until there is no air left in the cylinder.

After complete venting:

- Slowly extend and retract cylinder three to five times in idle state at low pressure.



Venting with Hänchen venting set

The Hänchen venting set permits venting hydraulic cylinders in a clean and easy manner without additional tools. It is screwed directly to the venting ports with measuring couplings that every Hänchen cylinder is equipped with.

Vent with Hänchen venting set as follows:

- Screw measuring couplings into venting ports.
- Make sure that venting screws are located at highest point of cylinder.
- Make sure that cylinder space in question is under low pressure (approx. 20 bar to 50 bar).
- Screw venting set onto measuring coupling.

When the oil flowing into the bottle of the venting set is bubble-free:

- Remove venting set from measuring coupling.

If there is still air in the cylinder:

- Repeat venting process until there is no air left in the cylinder.

After complete venting:

- Slowly extend and retract cylinder three to five times in idle state at low pressure.

6.4.2 Flushing of the pipes

- When flushing, position the flushing plates as close to the consumer (e.g. hydraulic cylinder, valves) as possible.
- Connect P- and T-type lines.
- Make sure that the consumers are not filled during the flushing process.

i The time required for flushing depends on the size of the system (duration: one hour up to several days).

6.4.3 Installation of accessories

- i** On piston rods with diameters of up to 25 mm (with female thread), the screwed-in mounting elements such as plain rod eyes, rod balls, rod clevises, etc. are secured with adhesive.
- i** On piston rods with diameters of more than 30 mm, the screwed-in mounting elements are secured with radial threaded pins.

NOTICE

Damage to seal caused by heat!

- Extend piston rod completely to prevent damage to seals in cover.

For removing a mounting element secured with adhesive:

- Heat the piston rod in the area around the entire threaded hole to approx. 150 °C to soften the adhesive.

When installing a mounting element:

- Secure mounting element using suitable varnish fastener.

NOTICE

Damage to spherical bearing or bearing bushing and the cylinder due to incorrect installation!

- Support spherical bearing or bearing bushing against inner ring when pressing in.
- Follow the lubrication stipulations
- Note the information concerning adjustable spherical bearing

6.4.4 Cushioning

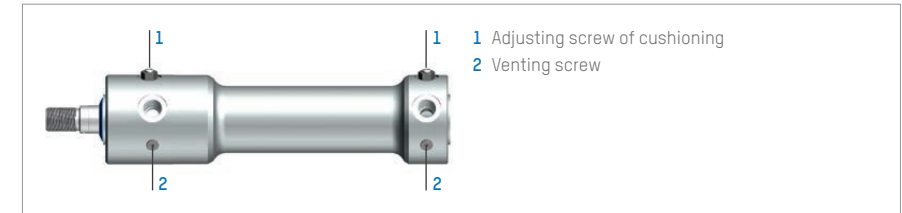

Figure 9: Adjusting the cushioning

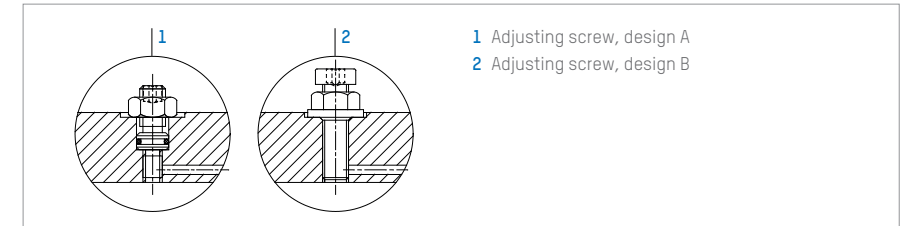

Figure 10: Designs of adjusting screw of cushioning

Adjust hydraulic cylinder or pressure intensifier with adjustable cushioning as follows:

To increase cushioning effect:

- Turn adjusting screw to the right.
- Secure adjusting screw using lock nut.

To reduce cushioning effect:

- Turn adjusting screw to the left.
- Secure adjusting screw using lock nut.

i An exact adjustment of the cushioning is exclusively possible during operation.

⚠ DANGER!

Danger to life due to fluids under pressure!

- Make sure that venting screw is not unscrewed too far.



Check the maximum screw-out as follows:

- Screw in adjusting screw as tight as possible.
- When hydraulic cylinder is moving into cushioning area: Unscrew adjusting screw by one turn at every stroke until the cushioning effect decreases.
- When the hydraulic cylinder hits the end position uncushioned, turn the adjusting screw another 2 to 3 times at the most.

6.4.5 Proximity switch

NOTICE

Damage due to incorrect use of proximity switch!

- Use pressure-resistant inductive proximity switches exclusively for no-contact position detection.
- Screwing in the proximity switch too far will cause mechanical destruction.

NOTICE

Damage to the Hänchen product due to unsuitable proximity switches!

- Use exclusively proximity switches acquired from Hänchen.

Install proximity switch as follows:

- Lubricate o-ring and support ring (e.g. with operating fluid).
- Screw proximity switch into the corresponding threaded hole on the Hänchen product.
- If not specified otherwise, screw in proximity switch as far as possible, and then loosen it again by a ¼ turn.
- Tighten up the lock nut of the proximity switch to max. 15 Nm unless specified otherwise by the manufacturer.

i Changing the length of engagement of the proximity switch permits changing the switching point.

6.5 Installation of clamping device Ratio-Clamp®

▲ DANGER!

Danger to life due to failure of clamping device Ratio-Clamp®!

- Install clamping device Ratio-Clamp® according to specification or respective drawing.
- Make sure that clamping device Ratio-Clamp® is installed without distortions (caused by improper installation).

▲ WARNING!

Danger of injury due to stressed spring elements!

- Make sure that clamping device Ratio-Clamp® is installed and removed exclusively by trained specialised personnel.

▲ CAUTION!

Malfunctions caused by signal errors!

- Install signal lines in an EMV-compatible way.
- Ensure static discharge before installation.
- Establish proper ground connection.

6.5.1 Installation and venting

- Use all hydraulic ports of the Ratio-Clamp® clamping device.

- Make sure that the return pipe of the valve or valve combination for controlling the Ratio-Clamp® clamping device is not pressurised.
- Vent as described in chapter 6.4.1.

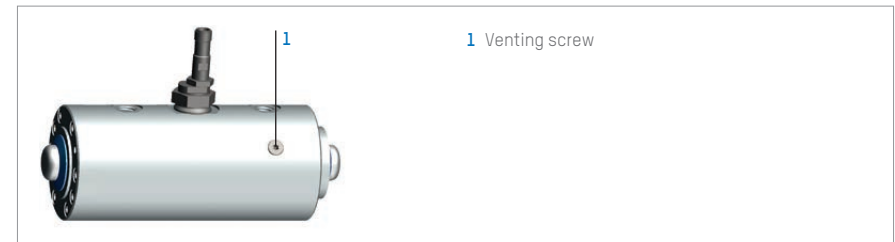

Figure 11: Venting screw

- Before start-up, vent clamping device Ratio-Clamp® using a Hänchen venting set.

i The venting set is available as equipment.

6.5.2 Flushing of the pipes

For further information on this, see chapter 6.4.2.

6.5.3 Activation

When a clamping device Ratio-Clamp® is used together with a hydraulic cylinder, observe the following order for the activation:

- Loosen clamping device Ratio-Clamp® by applying pressure to releasing port.
- Move rod by pressurizing piston surfaces in cylinder.

When rod has reached required position:

- Set A- and B-port of cylinder to zero pressure.
 - Set releasing port of cylinder to zero pressure.
- Clamping device Ratio-Clamp® is locked.

i With the use of a Hänchen control block between directional valve and clamping device Ratio-Clamp®/cylinder unit, the described procedure is effected automatically. The control block provides correct and sequentially logical control thus minimizing the required wiring complexity for the user.

6.5.4 Proximity switch

For information on the installation of the proximity switch, see chapter 6.4.5.

i Hänchen recommends installing a conductive proximity switch that indicates whether the clamping device Ratio-Clamp® is locked or released. Proximity switches are contact-free and wear-free. The optional additional diagnostic output monitors the function of the switch and the supply line.

Checking setting of proximity switch

i The proximity switch is delivered with the desired indicator setting (locked or released) according to the documentation.



- Check setting of proximity switch as follows: Pressurize clamping device Ratio-Clamp® with minimum releasing pressure.

Switch switches to required position.

- If necessary, change setting of proximity switch.

Changing settings of proximity switch

Set indicator of proximity switch to Locked as follows:

- Relieve pressure on clamping device Ratio-Clamp® (pressure < minimum releasing pressure).

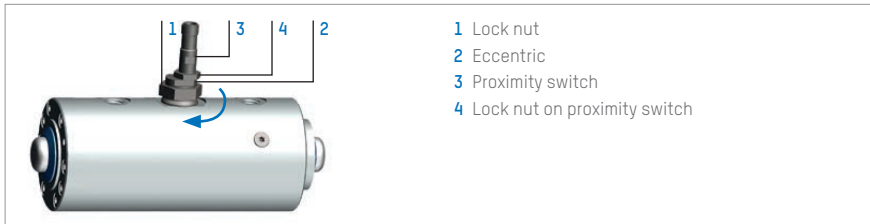

Figure 12: Set proximity switch to locked

- Unscrew lock nut (1) on connecting piece.
- Rotate eccentric (2) until proximity switch closes and indicator lights up.
- Tighten lock nut (1).
- Pressurize clamping device Ratio-Clamp® with minimum releasing pressure. Proximity switch opens. Indicator goes off.

Set indicator of proximity switch to released as follows:

- Pressurizing clamping device Ratio-Clamp® with minimum releasing pressure.

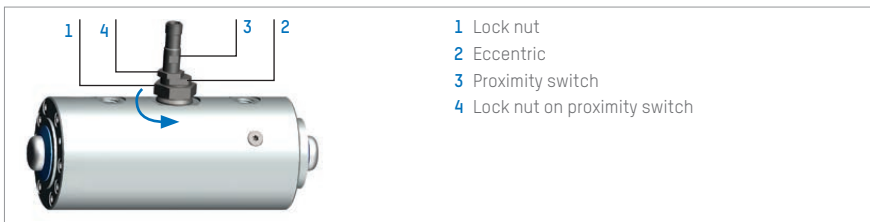

Figure 13: Set proximity switch to released

- Unscrew lock nut on connecting piece (1).
- Rotate eccentric (2) until proximity switch closes and indicator lights up.
- Tighten lock nut (1).
- Relieve pressure on clamping device Ratio-Clamp® (pressure < minimum releasing pressure). Proximity switch opens. Indicator goes off.

Faults

When proximity switch does not send any signal, or does not send a signal in the required position:

- Make sure that operating voltage of 10 VDC to 30 VDC is applied on proximity switch.
- Pressurize clamping device Ratio-Clamp® with minimum releasing pressure.
- Make sure that clamping device Ratio-Clamp® is released.

When clamping device Ratio-Clamp® is released:

- Unscrew lock nut (1) on connecting piece.
- Rotate eccentric (2) until proximity switch closes or indicator lights up.
- Tighten lock nut (1) at 70 Nm max.
- Relieve pressure on clamping device Ratio-Clamp®.
- Make sure that indicator goes off or switch opens.

When proximity switch switches neither in released nor in locked state:

- Remove plug.
- Unscrew lock nut.
- Screw out proximity switch.
- Connect plug.
- Verify that operating voltage of 10 VDC to 30 VDC is applied on proximity switch.

When operating voltage is applied:

- Move front end of proximity switch towards steel element.

If proximity switch switches approx. 0.5 mm to 0.8 mm before touching the steel part:

Proximity switch is working correctly.

- Reinstall proximity switch.
- Tighten up the lock nut on proximity switch (4) to max. 15 Nm.

If proximity switch does not switch approx. 0.5 mm to 0.8 mm before touching the steel part:

Proximity switch is defective.

- Replace proximity switch.

6.5.5 Installation

⚠ DANGER!

Danger to life due to incorrect installation!

- Do not use transport rod for clamping.
- Tighten screws only when clamping device Ratio-Clamp® is installed completely.
- Do not tighten screws when no rod is installed.
- Never pressurize clamping device Ratio-Clamp® when no rod is installed.
- Never pressurize clamping device Ratio-Clamp® as delivered (with transport o-ring).

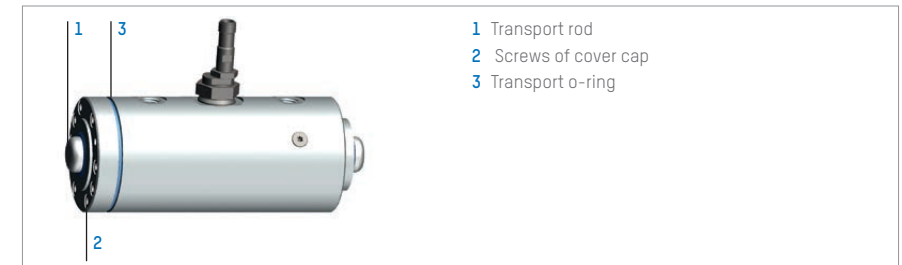

Figure 14: Installation of clamping device Ratio-Clamp®



- Loosen screws (2) on cover cap by one turn each.
- Cut and remove marked transport o-ring (3).
- Carefully slide the transport rod (1) with the rod to be clamped out of the clamping device Ratio-Clamp®.
- Put clamping device Ratio-Clamp® into required position.
- Tighten unscrewed screws on cover cap crosswise until cover cap is resting on cylinder tube without gaps.
- Observe torque according to VDI 2230. See table 2.

6.6 Installation of vibration and structure-borne sound absorber

NOTICE

Damage to vibration and structure-borne sound absorber or piping due to vibrations caused by pump drive!

- Use a flexible hose to connect oil outlet side of vibration and structure-borne sound absorber to hydraulic system.
Minimum hose length:
 - Pipe diameter ≤ 18 mm: 600 mm
 - Pipe diameter > 18 mm: 900 mm
- Avoid narrow loops or bends of the hose.

- Make sure that fluid always flows through absorber in direction of imprinted arrow (flow direction).
- Install absorber near pump.
- Connect pressure port of pump directly to vibration and structure-borne sound absorber using a pressure hose.

For correct venting:

- Make sure that output port of vibration and structure-borne sound absorber is at the highest point.

For optimal muffling of noises:

- Install fastening clamps of vibration and structure-borne sound absorber using the supplied shock mounts.
- Observe the following limit values (see type plate):
 - working pressure
 - max. flow rate

7 Start-up

▲ DANGER!

Danger to life due to incorrect start-up!

- Make sure that the start-up is carried out correctly and exclusively by trained specialised personnel or certified hydraulic specialists.

▲ DANGER!

Danger to life due to high pressure!

- Only start up the machine or partly completed machine in which the Hänchen products are installed when the machine or partly completed machine meets the requirements of the Machinery Directive.
- Commission hydraulic systems exclusively with completely connected hydraulic and electric lines.

7.1 Start-up of hydraulic cylinders and pressure intensifiers

▲ DANGER!

Danger of injury due to malfunction or unexpected start!

Before start-up:

- Check correctness of port.
- Check correct response of drive position.

NOTICE

Installation grease on the piston rod!

- Remove any escaping installation grease from the piston rod after the first hours of operation.

Before start-up hydraulic cylinder or pressure intensifier:

- Make sure that the maximum pressure indicated on the type plate is not exceeded, not even during pressure peaks.
- Observe admissible values indicated on drawings and in the documentation, in particular for:
 - extending and retracting forces
 - temperature range
 - buckling strength
 - piston speed
- Remove preservative agent completely.
- Make sure that the sealing elements are not sticking due to the preservative agent.

NOTICE

Malfunctions and vibration due to incorrectly set accumulator pressure!

- Adjust the nitrogen preloading of the accumulator to produce smooth and quiet cylinder operation.

Leak oil and functional oil removal

For relevant information, refer to chapter 6.4.1. (Figures 5, 6, 7)

- Purge any leak oil and functional oil accumulating on the corresponding ports (4) at zero pressure up to 5 bar max.
- Do not use vacuum to extract functional oil.
- Connect leak oil port protection tube (3) at zero pressure.

7.1.1 Additional information on start-up of hydraulic cylinder sealing system Servofloat®

For illustration, see figure 6.

i The floating gap seal does not require an external pressure supply.

- Supply pressure
 - $p_{\min} = 50 \text{ bar}$
 - $p_{\max} = \text{according to type plate}$

7.1.2 Additional information on start-up on hydraulic cylinder guiding system Servobear®

For illustration, see figure 7.



For internal bearing pressure supply (standard):

- The hydrostatic bearing is supplied internally via channels in the cylinder.
- System pressure before servo valve
 $p_{\min} = 140 \text{ bar}$
 $p_{\max} = \text{according to type plate}$

For external bearing pressure supply (not standard):

- Connect port of hydrostatic bearing pressure to corresponding threaded connectors on cylinder (see relevant documentation).

7.2 Start-up of clamping device Ratio-Clamp®

Before start-up clamping device Ratio-Clamp®:

- Make sure that the maximum pressure indicated on the type plate is not exceeded, not even during pressure peaks.
- Observe the admissible values indicated on the drawing and on the order confirmation for:
 - maximum piston speed
 - operating temperature
 - holding loads
- Remove preservative agent completely.
- Make sure that the sealing elements are not sticking due to the preservative agent.

7.3 Start-up of vibration and structure-borne sound absorber

Before start-up vibration and structure-borne sound absorber:

- Make sure that the maximum pressure indicated on the type plate is not exceeded, not even during pressure peaks.
- Observe directions and admissible values indicated on drawings and on the order confirmation.
- Remove preservative agent completely.
- Make sure that the sealing elements are not sticking due to the preservative agent.
- Observe direction of flow.

8 Removal from service

8.1 Disassembly

⚠ DANGER!

Danger to life due to incorrect removal from service!

- Make sure that the removal from service is carried out correctly and exclusively by trained specialised personnel or certified hydraulic specialists.

⚠ DANGER!

Danger to life due to high pressure!

- Open screw connections and hydraulic lines exclusively at zero pressure.

8.2 Disposal

NOTICE

Environmental pollution and danger of slipping due to leaked hydraulic oil!

- Immediately absorb leaked hydraulic oil, or collect it in a suitable container.
- Dispose of leaked hydraulic oil in an environment-friendly manner.

- Dispose of Hänchen products in accordance with the national regulations.
- Only dispose of the cylinder when it is in a dismantled state.
- Send H-CFRP® components to a suitable incinerator for special waste for total thermal reclamation or to a recycling process.

9 Maintenance

⚠ DANGER!

Danger to life due to incorrect removal from service!

- Make sure that the removal from service is carried out correctly and exclusively by trained specialised personnel or certified hydraulic specialists.

- 📘 Maintenance and repair measures are described in the separate maintenance manual. Download maintenance manual at www.haenchen-hydraulic.com/service/download.html.

9.1 Hydraulic cylinders and pressure intensifier

Depending on operational demands, but at least once a year:

- Check hydraulic cylinders and pressure intensifier for damage.
- Check hydraulic cylinders and pressure intensifier for wear.
- Replace damaged or worn component parts.

9.2 Clamping device Ratio-Clamp®

After two million clampings at the latest:

- Have clamping device Ratio-Clamp® checked by Hänchen.

- 📘 Have clamping device Ratio-Clamp® with safety function tested by Hänchen after a million clamping operations.

Depending on operational demands, at regular intervals, at least every six months or after longer periods of non-operation:

- Check tightness.
- Make sure that holding load is as indicated in the documentation.

Depending on operational demands, but at least once a year:

- Have state and effectiveness of clamping device Ratio-Clamp® checked by a specialist.
- Observe statutory regulations, such as accident prevention regulations.



9.3 Vibration and structure-borne sound absorber

Depending on operational demands, but at least once a year:

→ Check vibration and structure-borne sound absorber for damage.

10 Technical data

i For technical data, see specific product documentation, e.g. in HäKo, on the homepage under www.haenchen-hydraulic.com/technical-information and corresponding drawings and diagrams.



You want to know who's **your contact**?
You'll find our contacts at www.haenchen-hydraulic.com/contact.html.





HÄNCHEN®

Herbert Hänen GmbH & Co. KG

Brunnwiesenstr. 3, 73760 Ostfildern
Postfach 4140, 73744 Ostfildern
Fon +49 711 44139-0, Fax +49 711 44139-100
info@haenchen.de, www.haenchen.de