

7" Corner Applicator 4-701

Schematic #	Part #	Description
1	8291	Screw (8-32 x 3/8")
2	9317	Cone
3	7520	Cone Gasket
4	8291	Screw (8-32 x 3/8")
5	7521	App. Filler Gasket
6	7522	App. Flat Rubber
7	8261	Screw (10-32 x 1/2")
8	9318	7" App. Pressure Plate
9	7378	Thumb Screw
10	7409	Bearing
11	9315	Pivot Bearing
12	9314	Handle Connector
13	9312	7" App. Gasket
14	7053	App. Filler Valve
15	7414	Valve Sleeve
16	7051	Filler Spring
17	7050	(3-48) Lock Nut
18	8316	Valve Holder
19	8288	(8-32) Lock Nut
20	7792	Latch
21	9613	Plastic Washer
22	8310	7" Applicator Body

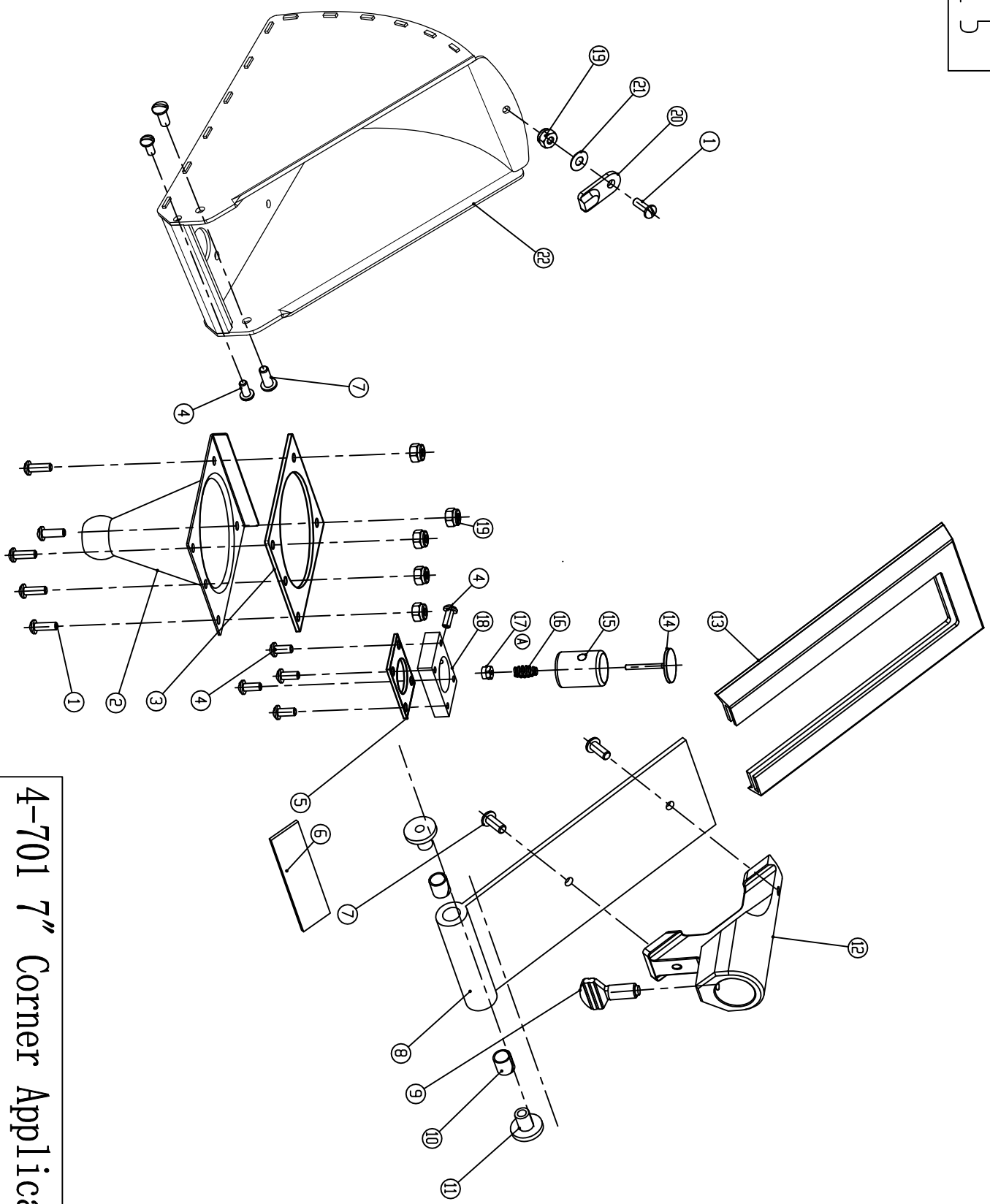

4-701 7" Corner Applicator