

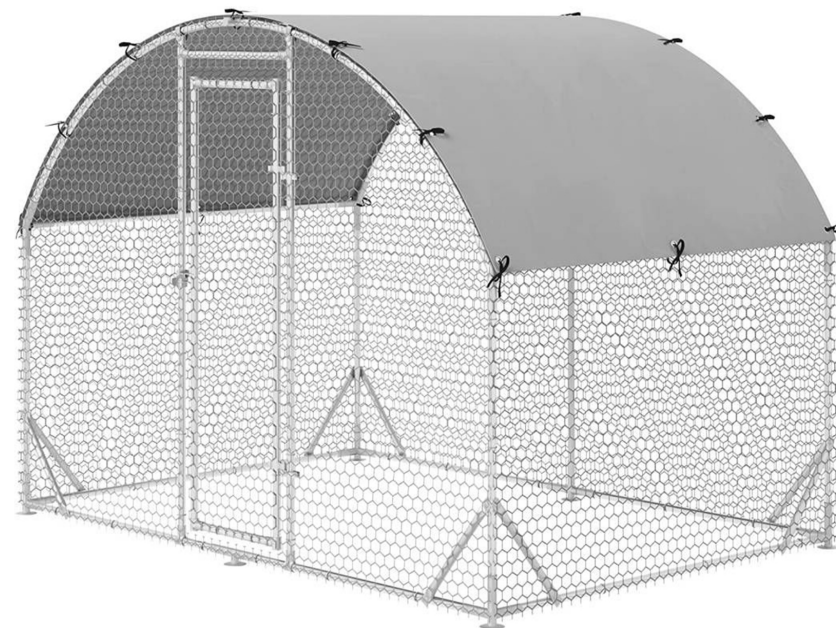











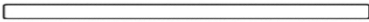

BETTERHOOD

PTB008SL



IMPORTANT, RETAIN FOR FUTURE REFERENCE: READ CAREFULLY

ASSEMBLY & INSTRUCTION MANUAL

	① x 4 1320
	② x 2 1825
	②A x 2 1825
	③A x 4 970
	④ x 1 1855
	⑤ x 1 1835
	⑤A x 1 1835
	⑥ x 1 615
	⑦ x 4 1115
	⑧ x 2 1115
 Φ16 400mm	⑩ x 8 400
	A x 2 1700
	C x 2 497
	B x 1 1835

D x 4



E1 x 2



E2 x 2



F x 1



G x 1



I x 22



J x 2



K x 29



M6
+1(spare)

L x 6



M8
+1(spare)

M x 1

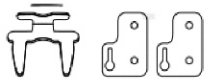

O x 1

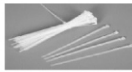

P x 1



Q x 1

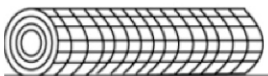

R x 16

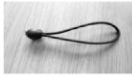

S x 1



T x 2



W x 6

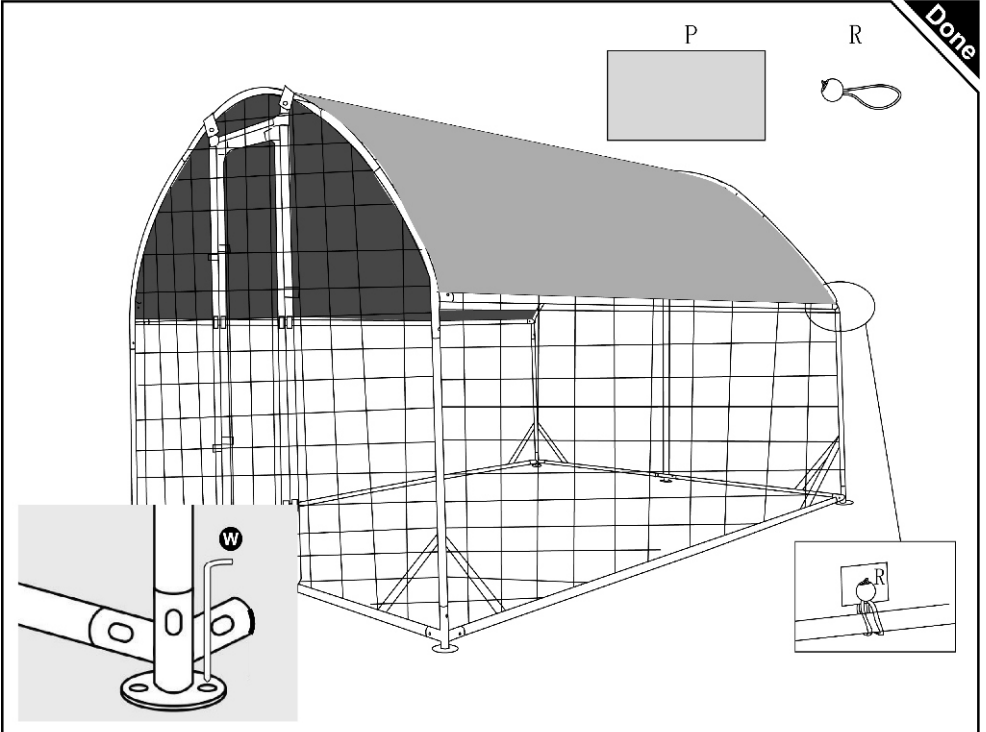
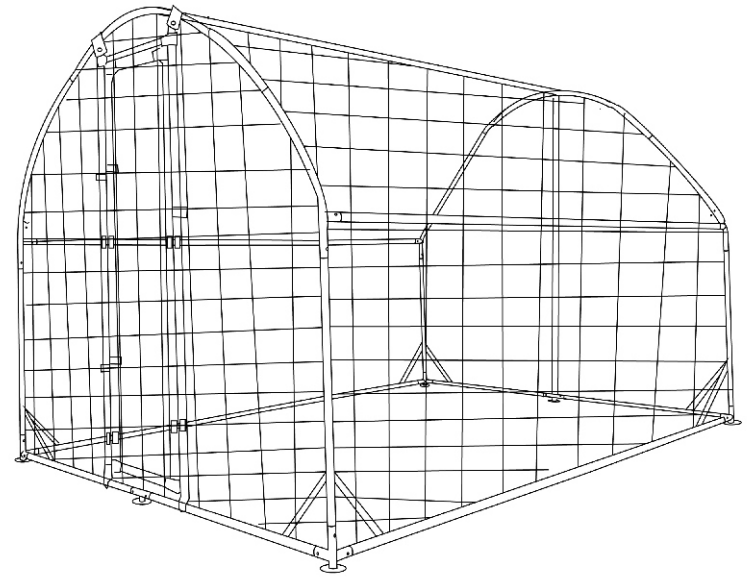
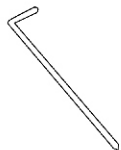

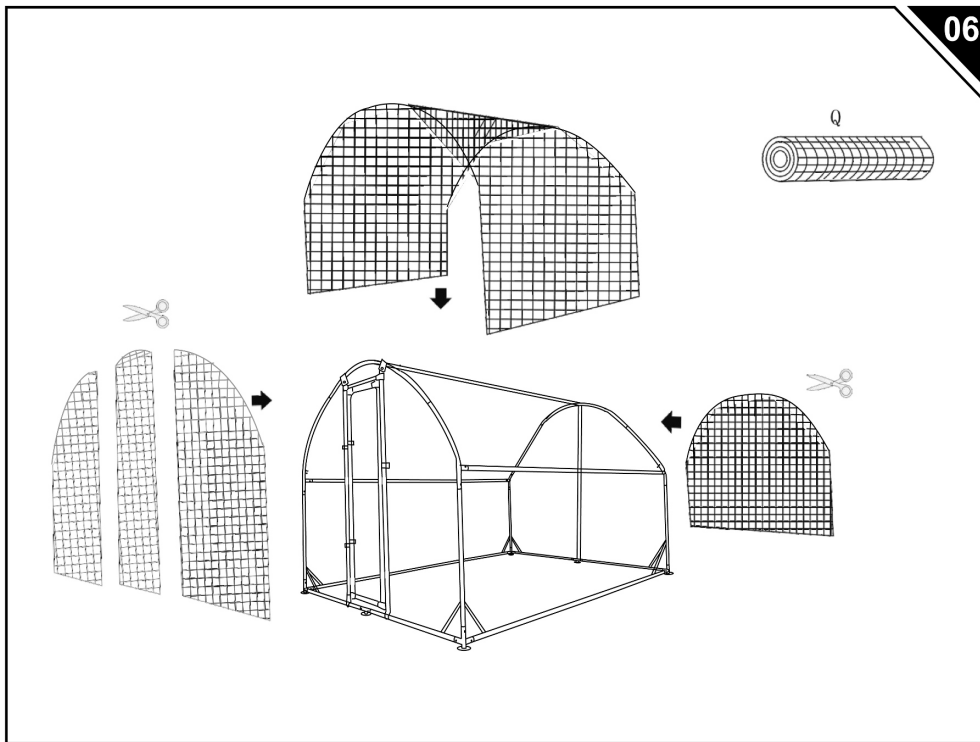
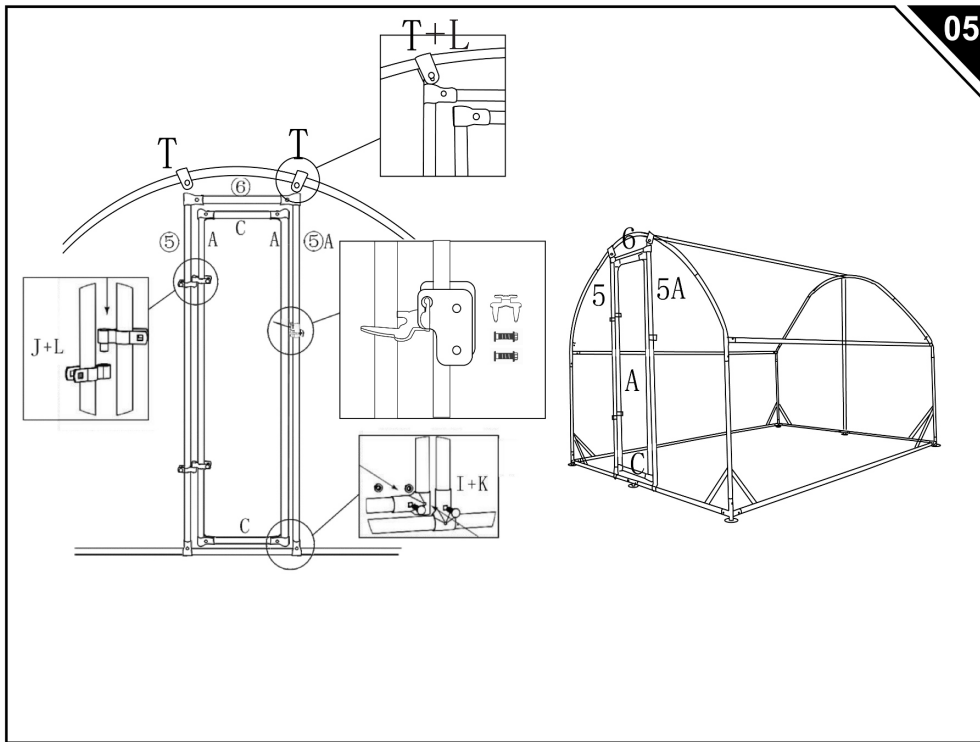

**DIFFERENT HOLES SITUATIONS
IN E1 & E2**

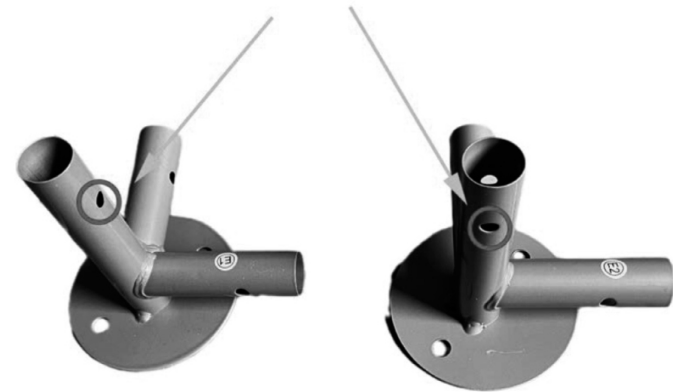

E1

E2

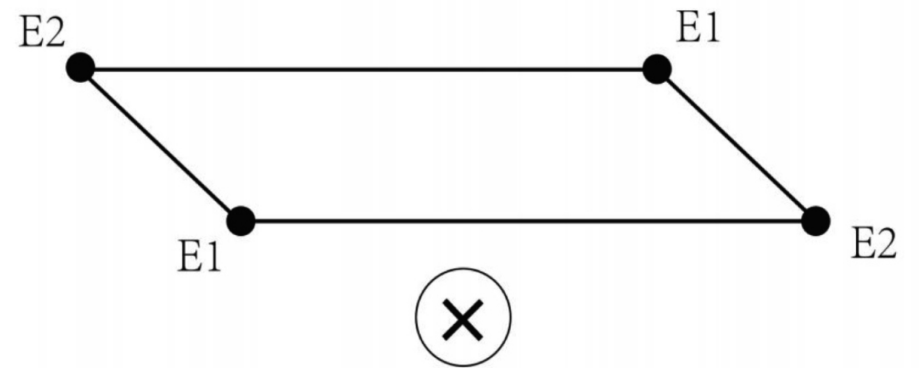
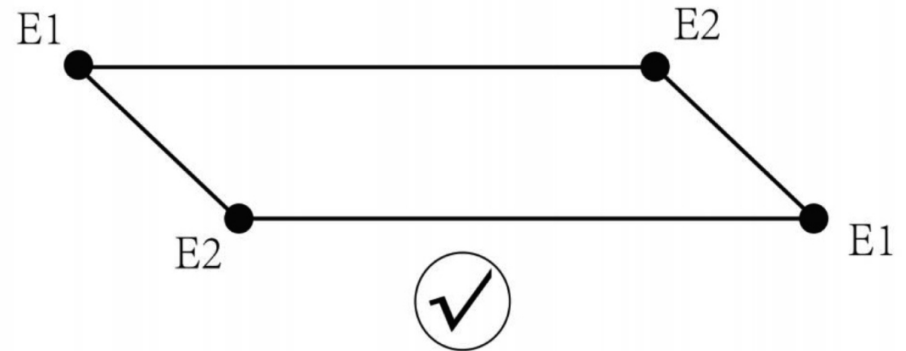

01

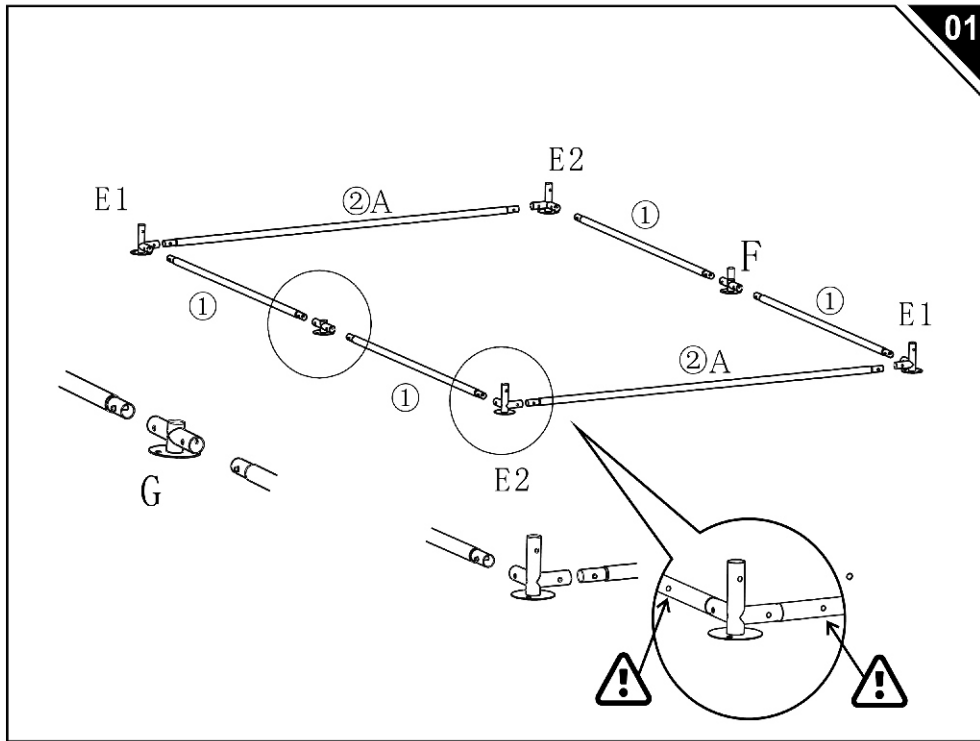

03

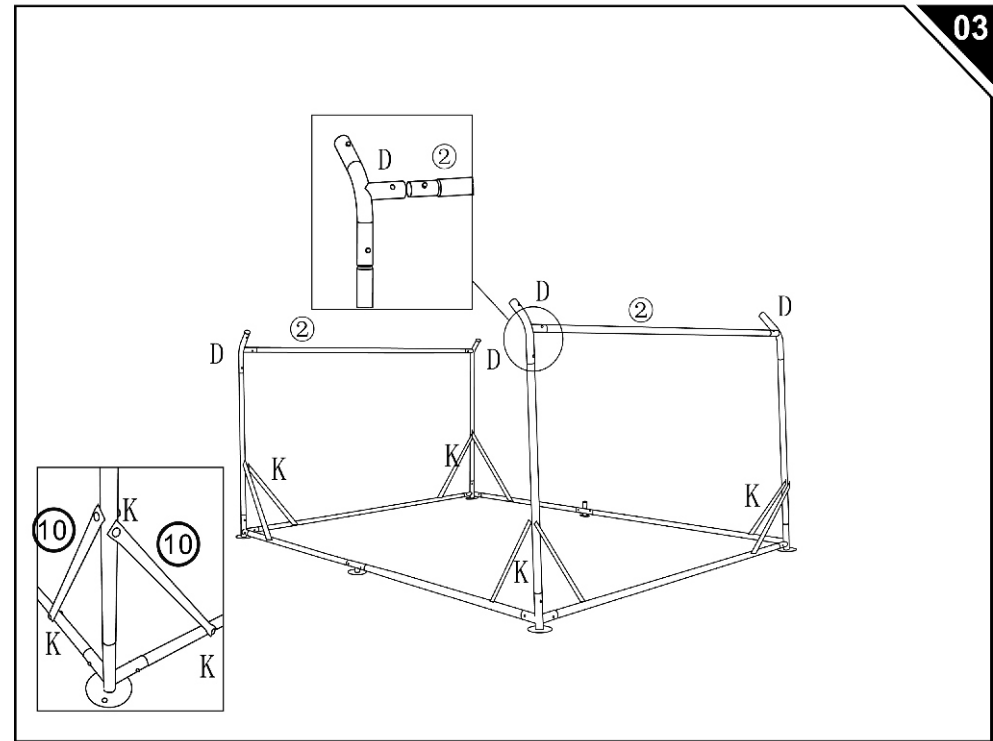

02

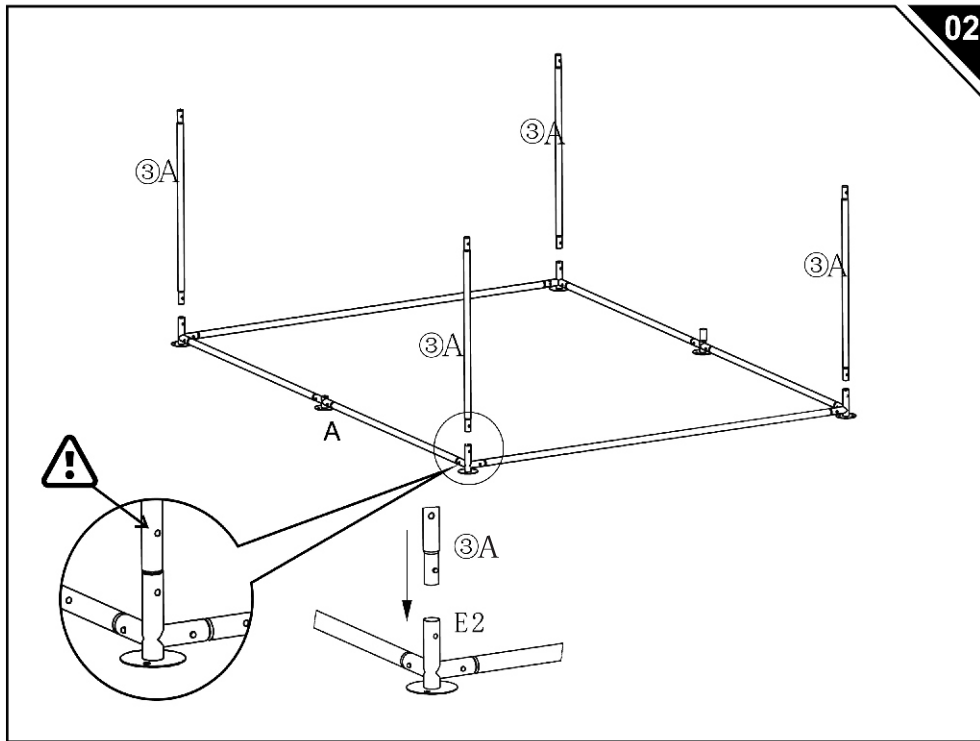

04

