

SPECIFICATIONS

Speed Range: 3.25 – 100.50 in/min [8.26 – 255.27 cm/min]

Gun Positioning Slides: 1-3/4" (44.5 mm)
Vertical and Horizontal Stroke

Weight of MOGGY®: 31 lbs. (14.1 kg)
complete with all attachments (single gun model)

Supply Voltage: Either 42, 115, or 230 VAC,
single phase, 50/60 Hz., 30 watts

Drive Motor:
24 VDC permanent magnet gear motor

Drive Wheel Temp Range:
-65°F to 450°F (-54°C to 232°C)

Complies with: C.S.A. & N.R.T.L.
(file #LR35006-8) & C.E. Certification.

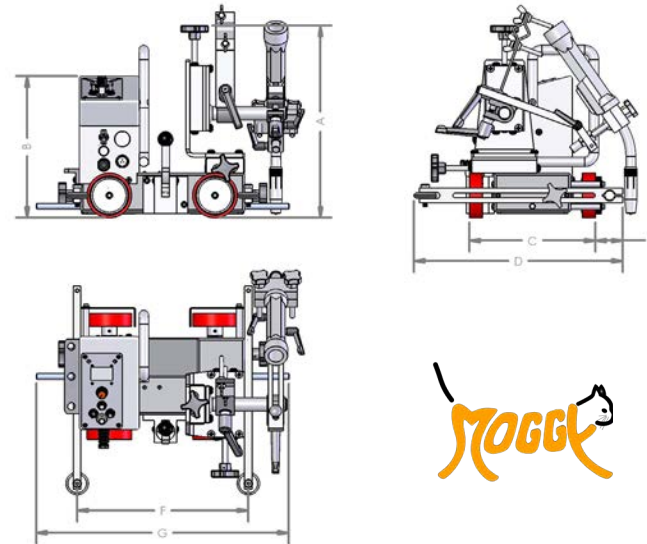
CARRIAGE DIMENSIONS

| | IMPERIAL | METRIC |
|----------|---------------------|--------------------------|
| A | 12.90" | 327.3 mm |
| B | 9.50" | 241.3 mm |
| C | 8.45" | 214.6 mm |
| D | 14.01" | 355.7 mm |
| E | Min 1.95" Max 5.46" | Min 4.93 mm Max 138.7 mm |
| F | 11.50" | 292.1 mm |
| G | 17.00" | 431.8 mm |

KAT, KBM, MOGGY, KATBAK & SAM are registered trademarks of Gullco Enterprises Limited

Distributed by:

SPECIFICATIONS ARE SUBJECT TO CHANGE WITHOUT NOTICE. ALL DIMENSIONS ARE NOMINAL

GULLCO

CANADA - GULLCO INTERNATIONAL LIMITED
Phone: 1-905-953-4140 Fax: 1-905-953-4138 e-mail: sales@gullco.com

U.S.A - GULLCO INTERNATIONAL INC.
Phone: 1-440-439-8333 Fax: 1-234 808-4146 e-mail: ussales@gullco.com

EUROPE - GULLCO INTERNATIONAL (U.K.) LIMITED
Phone: +44 1257-253579 Fax: +44 1257-254629 e-mail: uksales@gullco.com

AUSTRALIA - GULLCO INTERNATIONAL PTY LIMITED
Phone: 61 (0)7 3348 5515 Fax: 61 (0)7 3348 5510 e-mail: ausales@gullco.com

INDIA - GULLCO INTERNATIONAL INDIA PVT LIMITED
Phone: +91-20-2551-1433 Fax: +91-20-2551-1433 e-mail: indsales@gullco.com

CHINA - GULLCO INTERNATIONAL SHANGHAI LIMITED
Phone: +8621-50460341 Fax: +8621-50463554 e-mail: c.zhang@gullco.com

SINGAPORE - GULLCO INTERNATIONAL LIMITED
Phone: +65-9385-4468 e-mail: benny.lim@gullco.com

LATIN AMERICA - GULLCO INTERNATIONAL LIMITED
Phone: 55-11-99485-1336 e-mail: rogerio.macedo@gullco.com

GERMANY - ms gmbh Melchior Schweißtechnik
Phone: +49(0)173 5437722 Fax: +49(0)208 999 38-38 e-mail: christian.mertens@ms-gmbh.com

GULLCO.COM

MAG2204

WELDING AND CUTTING AUTOMATION



TRACKLESS WELDING CARRIAGE - MAGNETIC MOGGY®



Magnetic base allows for out of position welding applications

Ideal for automatic horizontal fillet, lap or butt welding applications

Control allows for continuous or stitch welding operations

Dual gun holder assemblies make automated simultaneous welding efficient

The MOGGY® can be equipped with a variety of accessories including: weld oscillator, cutting torch attachment and internal radius guide wheels

GM-03-300 - MAGNETIC CARRIAGE

GM-03-400 - DUAL TORCH
MAGNETIC CARRIAGE



Automate Fillet, Lap, and Butt Welds with Precision

VERSITILE TRACKLESS AUTOMATION CARRIAGE FOR A VARIETY OF APPLICATIONS

GULLCO.COM



TRACKLESS AUTOMATION WELDING CARRIAGE

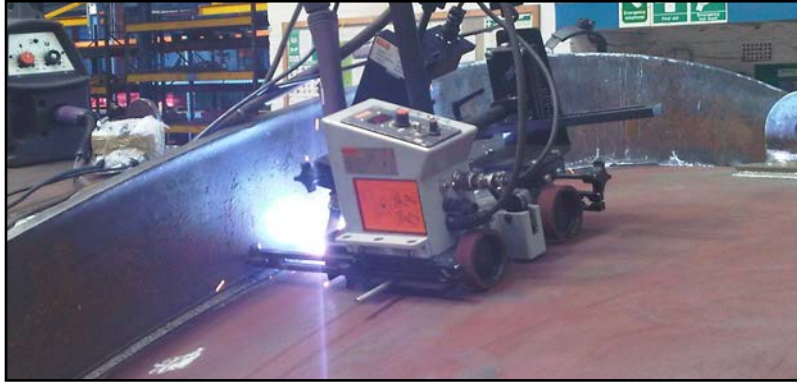

The Magnetic MOGGY® is intended to automate and improve the quality of welding and cutting operations by carrying the welding gun or cutting torch, at precisely controlled speeds, along the path of the joint as well as providing the interface between the welding and cutting motion and the arc start and stop signal. The Magnetic MOGGY® is normally guided by adjustable guide wheels which are used to keep a set distance from the joint path.

The carriage is flexible enough to allow it to be easily configured for horizontal lap, butt and fillet weld joints as well as a variety of cutting processes. The GM-03-300 model provides continuous mode welding and cutting and accurate distance stitch weld functionality, regardless of travel speed adjustment. Using the Magnetic MOGGY® automation carriage system will add accuracy and uniformity to welding and cutting operations while increasing productivity. Typical applications include shipbuilding, offshore construction, steel fabrication industries, etc.

MAGNETIC MOGGY CARRIAGE - GM-03-300

Magnetic MOGGY® Carriage with control for continuous or stitch welding, and with a control that uses a Gullco microprocessor to provide accurate repeatability regardless of travel speeds for weld distance on and weld distance off. It has a forward/stop/reverse switch, wire feed start on/off switch, travel speed potentiometer, auto wire feed start with delay carriage start, wire feed connector with 15 ft. (4572mm) control cable. All functions displayed in an LED window.

FILLET JOINT WELDING



The MOGGY® performing a fillet weld using a template, guide or fence positioned parallel to the workpiece. The actual workpiece is often used as the guide.

BUTT JOINT WELDING

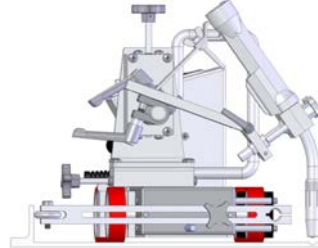

The MOGGY® is ideal for butt joint welding. Here the MOGGY® is using a fence to guide it accurately along the desired path.

LAP JOINT WELDING

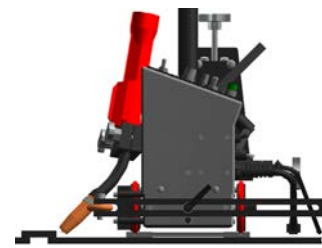

The MOGGY® is performing a lap joint weld. It is guided by the use of a fence or other trackable verticle member running the length of the joint.

DUAL GUN WELDING

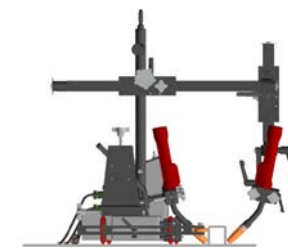

Dual gun holder assembly enables positioning of two guns and simultaneous activation of two wire feed signals. MOGGY® is guided by the workpiece.

JOINT TRACKING

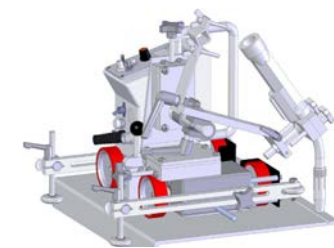

Adjustable height guide roller assemblies are available to track joints with a vertical member higher or lower than the set height of guide roller wheels.

RADIAL OSCILLATOR



Replaces the standard gun holder assembly in order to weave the gun across the joint while the MOGGY® provides the weld travel motion.



Precise Torch Alignment To The Seam

Adjustable guide rolls mounted on the front or back of the carriage monitor the slightest seam variations following straight or curved surfaces...maintaining optimum torch positioning as the carriage travels.

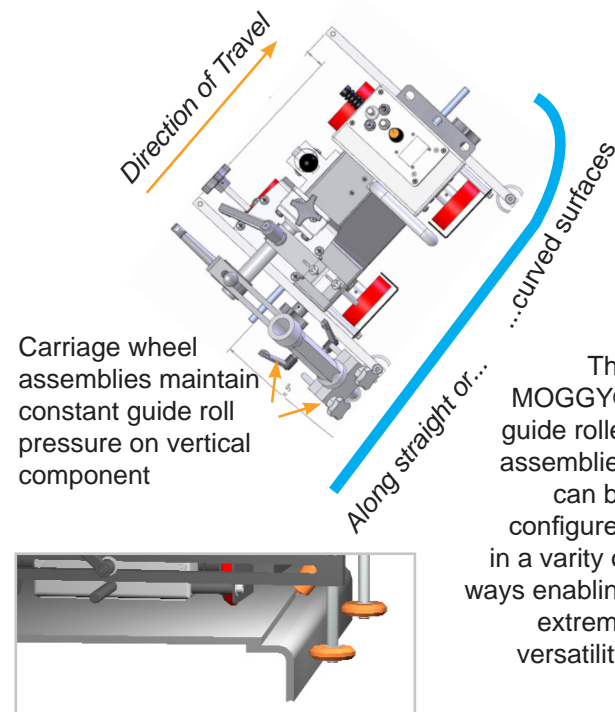

The MOGGY® guide roller assemblies can be configured in a variety of ways enabling extreme versatility.

CARRIAGE CONTROL LAYOUT

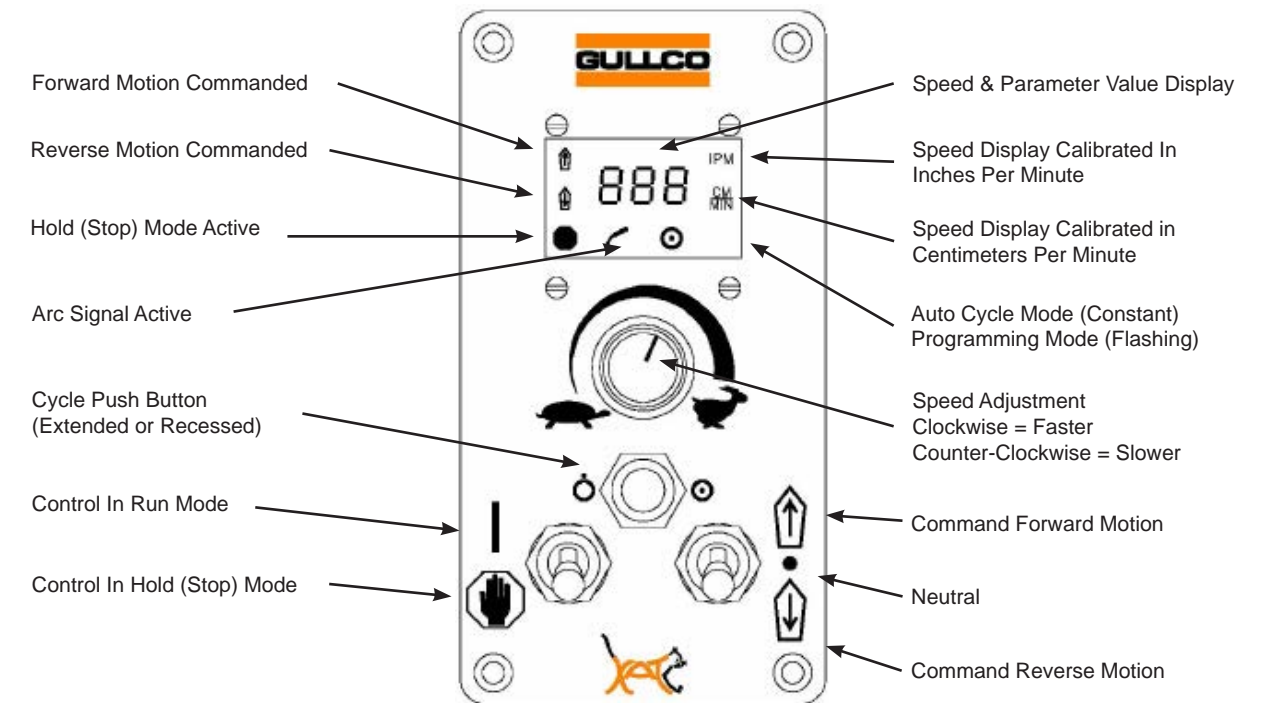

Accessories available:

GK-194-O-330 - Radial Oscillator complete with bracketry for mounting on Gullco MOGGY® Carriage.

GM-03-059 - Adjustable Guide Roller Assembly enables joint tracking where the vertical member is lower/higher than set height of guide roller wheels.

GM-01-065 - Cutting Torch Holder Assembly enables automated torch cutting operations.

Also available as a SUBMERGED ARC MOGGY®

For more information on the submerged arc welding carriage and other products visit.

www.gullco.com

