

THUNDER Pro TE19 Thermal Image Scope



HIKMICRO THUNDER Pro TE19 Thermal Image Scope has 256 × 192 thermal detector and 1024 × 768 OLED monitor, which provides clear image under harsh environment conditions like darkness, fog, smoke, dust, rain, snow, wood, camouflage, etc. The scope is mainly applied to scenarios such as hunting.

Key Features

- 256 × 192 thermal resolution, high sensitivity detector, NETD < 35 mK (25°C, F# = 1.0)
- Image processing technology: Adaptive AGC, DDE, 3D DNR
- 1024 × 768 resolution 0.39-inch OLED display
- Supports distance measurement, and hotspot function
- Supports video recording and snapshot, built-in EMMC (16 GB)
- Supports digital zoom and cursor function, palettes of color adjustable
- Up to 5 hours continuous working

▪ Specification

| Thermal Module | |
|---------------------------------|---|
| Image Sensor | VOx Uncooled Focal Plane Arrays |
| Max. Resolution | 256 × 192 |
| Frame Rate | 25 Hz |
| Pixel Interval | 12 μm |
| Response Waveband | 8 μm to 14 μm |
| NETD | < 35 mK (@ 25°C), F# = 1.0 |
| Lens (Focal Length) | 19 mm |
| Detection Range | 900 m |
| IFOV | 0.63 mrad |
| Field of View | 9.24° × 7.08° |
| Min. Focusing Distance | 1 m |
| Aperture | F1.0 |
| Magnification | 2.5 to 20 (x8 zoom) |
| Image Display | |
| Display | 1024 × 768, 0.39 inch, OLED |
| Palettes | Black hot, white hot, red hot, fusion |
| Exit Pupil | 6 mm |
| Eye Relief | 45 mm |
| Diopter (Range) | -5D to +3D |
| System | |
| Record Video | On-board video recording |
| Capture Snapshot | Yes |
| Standby Mode | Yes |
| Uniformity Correction | Auto, Manual, External Correction |
| Storage | Built-in EMMC (16 GB) |
| PIP | Yes |
| DPC | Yes |
| Hotspot | Yes |
| Digital Zoom | 1X, 2X, 4X, 8X |
| Hot Track | Yes |
| Reticle | Yes |
| Distance Measurement | Yes |
| Power Supply | |
| Battery Type | Replaceable Applicable type: CR123A, RCR123A |
| Battery Operating Time | 5 h |
| Battery Capacity Display | Yes |
| Anti-reverse Battery Connection | Yes |
| Overvoltage Protection | Yes |
| Type-C Power Supply | Yes |
| General | |
| Work Temperature/Humidity | -20°C to 55°C (-4°F to 131°F) |

| | |
|-------------------|--------------------------------------|
| Protection Level | IP67 |
| Vibration & Shock | 750 g/1 ms |
| Dimension | 187.2 mm × 62.5 mm × 59.2 mm |
| Weight | 415 g without eyepiece and batteries |
| Port | Type-C |

▪ **Available Model**

HM-TR12-19XG/W-TE19

▪ **Dimension**

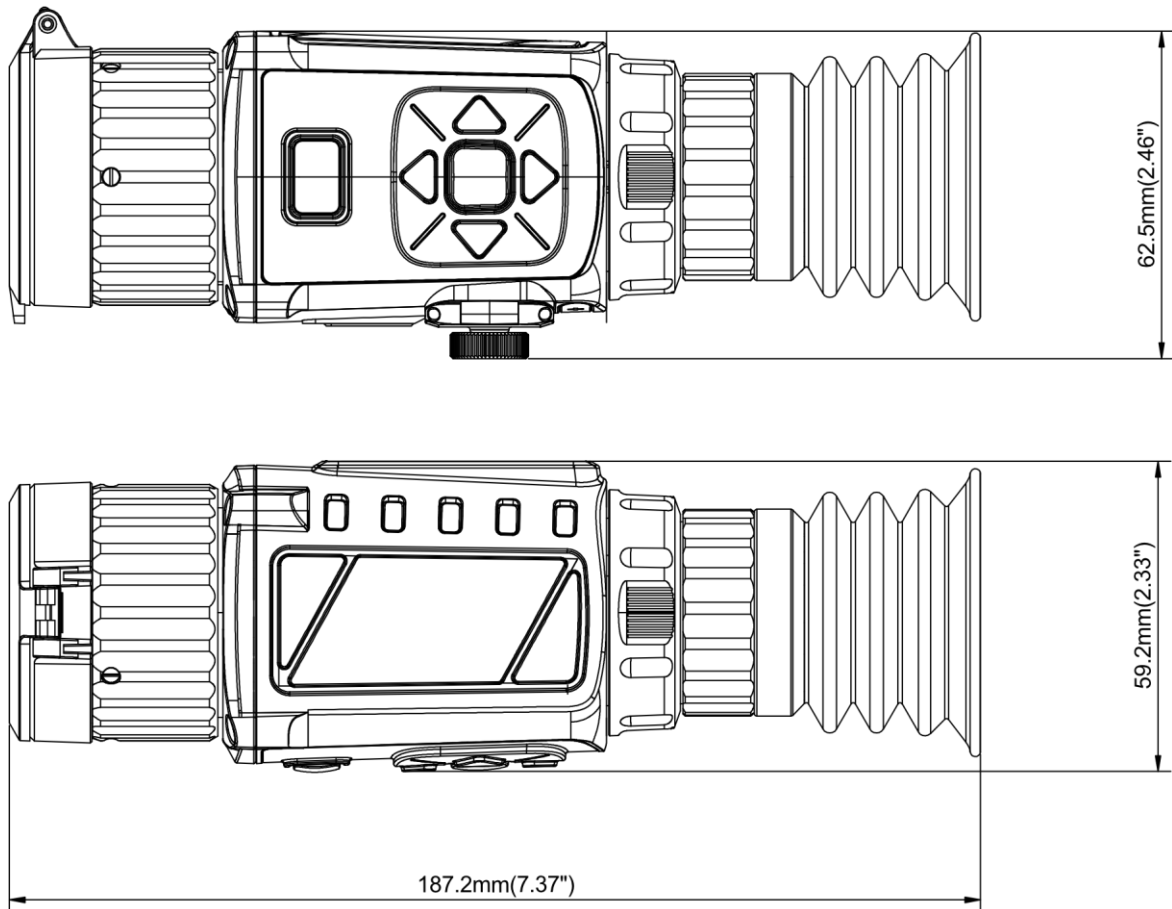

Accessory

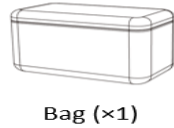
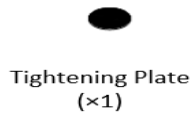
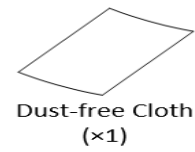
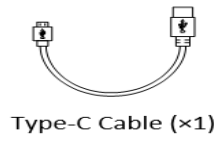
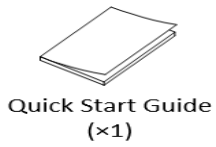

Optional

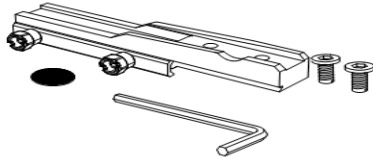

Rail System
Rail (×1)
Tightening Plate (×1)
Screws (×2)
Wrench (×1)

COMPLIANCE NOTICE: The thermal series products might be subject to export controls in various countries or regions, including without limitation, the United States, European Union, United Kingdom and/or other member countries of the Wassenaar Arrangement. Please consult your professional legal or compliance expert or local government authorities for any necessary export license requirements if you intend to transfer, export, re-export the thermal series products among different countries.

