

16mm F2.0 ED AS UMC CS Lens Instruction Manual

Thank you for purchasing the f=16mm F2.0 ED AS UMC CS lens.
We believe that you will have a special photographic experience with the 16mm F2.0 ED AS UMC CS lens.

Advantages of the 16 mm F2.0 ED AS IF UMC CS lens

- Image size of the digital APS-C (1:1.5x)
- It compensates for aberrations by using a complex aspherical lens and, at the fully opened position, produces a high resolution and a high contrast at the center of the lens as well as around the periphery.
- The detachable flower-shaped hood and UMC (Ultra Multi Coating) design suppresses flaring and ghost images.
- High strength aluminum body with robust durability

This product is designed with its own mount so you can easily take photographs by mounting the lens directly onto the camera, without installing an additional adaptor.

Read this manual carefully to familiarize yourself with your lens for correct use.
* Please read the Safety Precautions at the back of this instruction manual prior to use.

● Please read this instruction manual prior to use. ●

1. Component Names

[Figure]

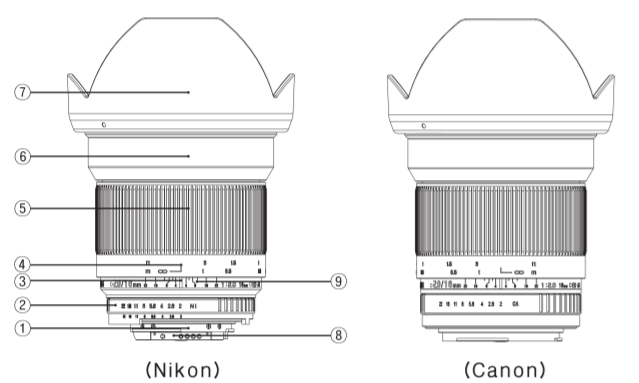

- Mount
- Aperture adjustment ring
- Distance scale
- Focus scaling ring
- Focusing ring
- Hood locking tube
- Hood
- CPU (electronic contacts)
- Depth of field scale

2. Attaching and Detaching

The 16mm F2.0 ED AS UMC CS lens mount is uniquely designed for Canon, Nikon (Fujifilm) F, Pentax (Samsung GX) K, Sony α (Minolta), Canon M, Sony E, Fujifilm X, Samsung NX, Four Thirds, and Micro Four Thirds cameras.

[Attaching]

Hold the lens hood gently and align the camera mount attachment point with the attachment reference point or line on the lens. Push the lens into the camera and gently rotate the lens in the attachment direction until it makes a clicking sound.

[Sony E Mount]

- Set the camera mode dial to M.
- Adjust the shutter speed by turning the dial to achieve the appropriate exposure for the brightness.

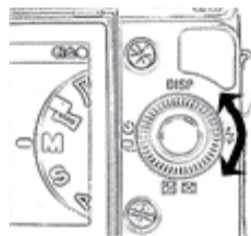

* For some Sony E cameras, if you set the camera mode dial to A and set the brightness by turning the aperture adjustment ring on the lens, the camera automatically changes the shutter speed. Therefore you don't need to adjust the shutter speed as well, which is required in M mode.

(The procedures above are for the NEX-5. The settings for the camera or the menu may vary based on the model or due to a functional upgrade. Refer to the camera manual or contact the camera manufacturer for detailed information.)

○ Four Thirds, Micro Four Thirds

The diaphragms of the 16 mm F2.0 ED AS UMC CS Four Thirds and Micro Four Thirds mounts are not compatible with the cameras. If the brightness is set to F8 or above, you may not be able to set the correct focus due to a difficulty in viewing the subject through the camera viewfinder. Turn the aperture adjustment ring so it is fully open when attaching the lens to the camera, and then set the depth of field and brightness you want prior to shooting.

[Four Thirds Mount]

- Hold down the MODE button and turn the dial until it is set to M. (shooting conditions) MODE + control dial ► M mode setting (manual shooting)

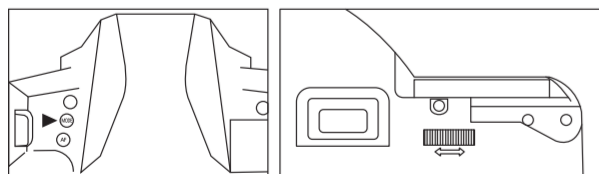

- Hold down the AF button and turn the dial until it is set to MF. (Focusing) AF + control dial ► MF setting (manual focusing)

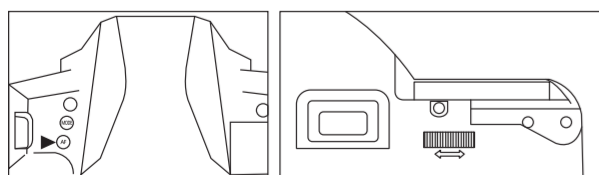

- Adjust the shutter speed to achieve the appropriate exposure for the brightness by turning the dial.

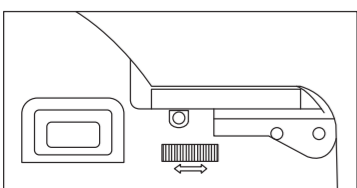

(The procedures above are for the Olympus E-3. The settings for the camera or the menu may vary based on the camera model or due to a functional upgrade. Refer to the camera manual or contact the camera manufacturer for detailed information.)

[Detaching]

Hold the lens hood gently and press the lens release button on the camera. Turn the lens in the opposite direction of the attaching direction to detach the lens.

3. Focus Adjustment

You can adjust the focus by turning the focusing ring when using the 16 mm F2.0 ED AS UMC CS lens, as it is a Manual Focus (MF) adjustment lens.

[Nikon (Fujifilm) F / Pentax (Samsung GX) K Mount]

- To change the focus from a subject that is far away to a subject that is close, turn the focusing ring to the left (= to 0.2 m) and focus on the clearest subject by using the indication signal on the camera, or by checking visually.
- To change the focus from a subject that is close to a subject that is far away, turn the focusing ring to the right (0.2 m to ∞) and focus on the clearest subject by using the indication signal on the camera, or by checking visually.

[Sony E / Canon, Canon M / FT, MFT / Samsung NX Mount]

- To change the focus from a subject that is far away to a subject that is close, turn the focusing ring to the right (= to 0.2 m) and focus on the clearest subject by using the indication signal on the camera, or by checking visually.
- To change the focus from a subject that is close to a subject that is far away, turn the focusing ring to the left (0.2 m to ∞) and focus on the clearest subject by using the indication signal on the camera, or by checking visually.

4. Brightness Control

You can set the depth of field and brightness by turning the aperture adjustment ring when using the 16 mm F2.0 ED AS UMC CS lens.
The F numbers can be set from 2.0 to 22.

5. Mounting the Hood

The hood has a bayonet system which guarantees speedy, efficient, safe and precise installation, and allows you to enjoy a shooting experience that is free from ghosting or flaring.

[Figure]

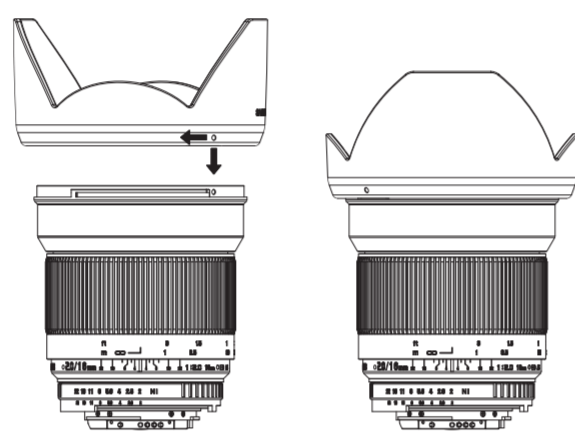

Align the attachment reference point on the hood with the reference point on the lens. Push the hood onto the lens and turn the hood to the right until it makes a clicking sound.

6. About Photography

The 16mm F2.0 ED AS UMC CS lens is a wide-angle lens and captures a vivid wide angle of view by minimizing image distortion. You can capture extensive panoramas, which is very useful for landscape shooting.

[Micro Four Thirds Mount]

- Set the camera mode dial to M.
- Adjust the shutter speed by turning the dial to achieve the appropriate exposure for the brightness.

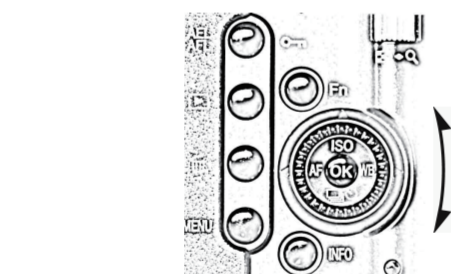
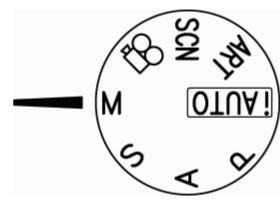

* For some Olympus (MFT) and Panasonic (MFT) cameras, if you set the camera mode dial to A and set the brightness by turning the aperture adjustment ring on the lens, the camera automatically changes the shutter speed. Therefore you don't need to adjust the shutter speed as well, which is required in M mode.

(The procedures above are for the E-P2. The settings for the camera or the menu may vary based on the camera model or due to a functional upgrade. Refer to the camera manual or contact the camera manufacturer for detailed information.)

8. Specifications

Focal length	16 mm	
Aperture range	F2.0 - 22	
Image sensor size	APS-C	
Angle of view	APS-C (1:1.5x)	83.1° (diagonal)
	APS-C (1:1.6x)	79.5° (diagonal)
	Four Thirds (4/3)	67.6° (diagonal)
Focusing range	∞ to 0.2 m	
Filter connection	Φ 77	
Number of elements	13 Elements	
Number of groups	11 Groups	
Size (without hood)	Canon	Ø 89.4 mm × Ø 83 mm
	Nikon	Ø 86.9 mm × Ø 83 mm
	Pentax	Ø 87.9 mm × Ø 83 mm
	Sony α	Ø 88.9 mm × Ø 83 mm
	Canon M	Ø 115.3 mm × Ø 83 mm
	Fujifilm X	Ø 115.7 mm × Ø 83 mm
	Samsung NX	Ø 107.9 mm × Ø 83 mm
	Sony E	Ø 115.4 mm × Ø 83 mm
	Four Thirds	Ø 94.7 mm × Ø 83 mm
	Micro Four Thirds	Ø 114.2 mm × Ø 83 mm
Weight (without hood)	Canon	583 g
	Nikon	571 g
	Pentax	574 g
	Sony α	575 g
	Canon M	613 g
	Fujifilm X	615 g
	Samsung NX	605 g
	Sony E	613 g
	Four Thirds	600 g
	Micro Four Thirds	610 g

7. Camera Settings

Some cameras require special settings when using this lens.
Please refer to the following and set the camera when necessary.

○ Canon Mount

The diaphragm of the 16 mm F2.0 AS UMC Canon mount is not compatible with the camera. If the brightness is set to F8 or above, you may not be able to set the correct focus due to a difficulty in viewing the subject through the camera viewfinder. Turn the aperture adjustment ring so it is fully open when attaching the lens to the camera, and then set the depth of field and brightness you want prior to shooting.

- Set the camera mode dial to M.

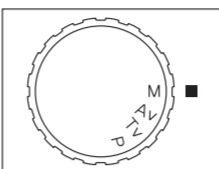

- Adjust the shutter speed to achieve the appropriate exposure for the brightness.



* For some Canon cameras, if you set the camera mode dial to Av and set the brightness by turning the aperture adjustment ring on the lens, the camera automatically changes the shutter speed. Therefore you don't need to adjust the shutter speed as well, which is required in M mode.

(The procedures above are for the 40D. The settings for the camera or the menu may vary based on the model or due to a functional upgrade. Refer to the camera instruction manual or contact the camera manufacturer for detailed information.)

○ Nikon (Fujifilm) Mount

Your Nikon mount has electronic contacts that allow it to communicate with Nikon AF cameras. These contacts enable the A, S, and P modes of the camera. When a subject is correctly in focus, the camera emits a beep or an indicator light comes on.

○ Pentax (Samsung GX) K Mount

The 16 mm F2.0 ED AS UMC CS Pentax (Samsung GX) K Mount supports Av mode.

- Align the A mode indicator to the distance scale indicator mark by pressing the A button on the aperture adjustment ring of the lens.

- Set the mode dial of the camera to Av.

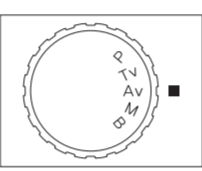

- Set the focus adjustment lever of the camera to MF.



- Camera Settings
The user sets the menu. ► The aperture ring is used. ► Not allowed.

- Adjust the brightness by turning the dial at the back of the camera.

(The procedures above are for the K20D. The settings for the camera or the menu may vary based on the model or due to a functional upgrade. Refer to the camera instruction manual or contact the camera manufacturer for detailed information.)

○ Sony (Minolta) α Mount

The diaphragm of the 16 mm F2.0 ED AS UMC CS Sony (Minolta) mount is not compatible with the camera. If the brightness is set to F8 or above, you may not be able to set the correct focus due to a difficulty in viewing the subject through the camera viewfinder. Turn the aperture adjustment ring so it is fully open when attaching the lens to the camera, and then set the depth of field and brightness you want prior to shooting.

- Set the camera mode dial to M.

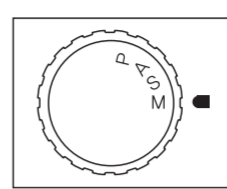

- Set the focus adjustment lever of the camera to MF.

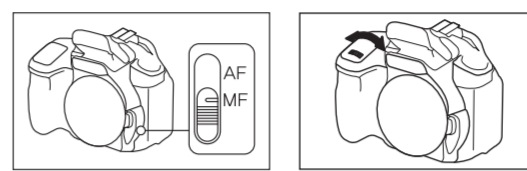

- Adjust the shutter speed to achieve the appropriate exposure for the brightness.

(The procedures above are for the α350. The settings for the camera or the menu may vary based on the model or due to a functional upgrade. Refer to the camera instruction manual or contact the camera manufacturer for detailed information.)

○ Konica Minolta (Minolta), DYNA Series Cameras

If this lens is used on some Konica Minolta (Minolta) or DYNA series cameras, the release lock function (misuse prevention function) of the camera must be disabled. It is required to disable the release lock function only on the first use, as below.

Disabling the release lock function

- Set the main switch of the camera to OFF.
- Detach the lens from the camera body and set the main switch of the camera to ON by pressing the following two buttons.

- | | |
|---|--|
| 9xi ... function button + AE lock button | 303si ... AV button + self mode button |
| 7xi ... function button + AE lock button | 303si SUPER ... drive button + spot button |
| 5xi ... function button + AE lock button | 101si ... self-timer button + flash button |
| 3xi ... Modification is required at a service center. | 360si ... self-timer continuous shooting button + screen select button |

- | | |
|---|---|
| 807si ... AEL button + shooting scene select button | α-Sweet ... self-timer continuous shooting button + spot button |
| 707si ... card button + spot button | α-Sweet S ... (set the function dial to multi light exposure) |
| 507si ... lens exchange button + ISO lock button | P button + self-timer button |
| DYNAX3L ... shooting scene select button + button | DYNAX30 ... self-timer button + turn the dial on the main body away from OFF. |

α-Sweet II II L ... Set the camera to custom function 14 and change selection number from 1 to 2 (N.A.).

α-7, -9, -Ti ... Set the camera to custom function 16 and change the selection number from 1 to 2 (N.A.).

α-Sweet digital ... Execute the following operation.

MENU → *2 → Release lock without the lens → To the right → N.A. → Execute ● → MENU

α-7 Digital - Execute the following operation.

MENU → *3 → Release lock without the lens → To the right → N.A. → Execute ● → MENU

* If the release lock is disengaged in the above way, the state of disengagement is maintained even though the main switch is turned off. If you want to enable the release lock function, perform the above procedure again.

(The settings for the camera or the menu may vary based on the camera model or due to a functional upgrade. Refer to the camera instruction manual or contact the camera manufacturer for detailed information.)

○ Mirrorless Cameras (Canon M, Samsung NX, Sony E, Fujifilm X)

The diaphragms of the 16 mm F2.0 ED AS UMC CS Canon M, Samsung NX, Sony E and Fujifilm X mounts are not compatible with the cameras. If the brightness is set to F8 or above, you may not be able to set the correct focus due to a difficulty in viewing the subject through the camera viewfinder. Turn the aperture adjustment ring so it is fully open when attaching the lens to the camera, and then set the depth of field and brightness you want prior to shooting.

[Canon M Mount]

- Set the exposure to manual exposure (M) and change the focus mode to MF.

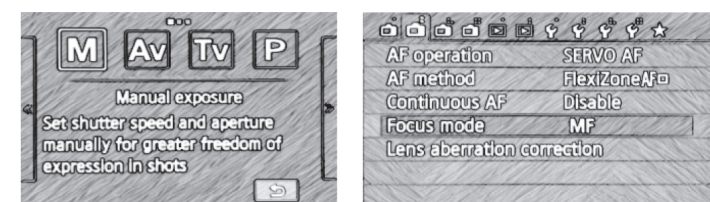

(The procedures above are for the Canon M. The settings for the camera or the menu may vary based on the camera model or due to a functional upgrade. Refer to the camera instruction manual or contact the camera manufacturer for detailed information.)

[FUJIFILM X Mount]

- Set the focus mode to M.

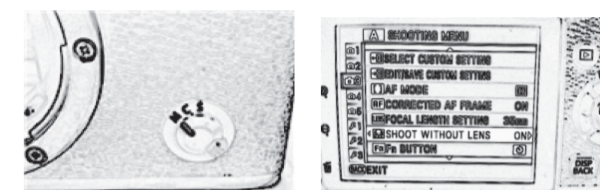

- Press the MENU/OK button, and select ON at 'Shoot without lens' in the shooting menu.

(The procedures above are for the X-Pro1. The settings for the camera or the menu may vary based on the camera model or due to a functional upgrade. Refer to the camera instruction manual or contact the camera manufacturer for detailed information.)

[Samsung NX Mount]

- Set the camera mode dial to M.
- Adjust the shutter speed by turning the dial to achieve the appropriate exposure for the brightness.



* For some Samsung NX cameras, if you set the camera mode dial to A and set the brightness by turning the aperture adjustment ring on the lens, the camera automatically changes the shutter speed. Therefore you don't need to adjust the shutter speed as well, which is required in M mode.

(The procedures above are for the NX200. The settings for the camera or the menu may vary based on the camera model or due to a functional upgrade. Therefore refer to the camera manual or contact the camera manufacturer for detailed information.)

9. Troubleshooting

Issue	Causes	Corrective Action
A lens cannot be attached to the camera.	The attachment reference point on the lens is not aligned with the lens attachment reference point on the camera.	Align the attachment reference point on the lens with the lens attachment reference point on the camera.
A lens cannot be detached from the camera.	Incorrect rotation direction for detaching the lens. If you turn the lens while holding the camera, it may cause damage to the lens.	Press the lens release button on the camera, and gently turn the lens to the lens attaching/detaching reference points in the direction as marked on the camera, and then pull the lens forward.
Blurry images	Incorrect focusing Insufficient shutter speed or camera shake.	Turn the focusing ring while checking the indication or checking an object visually, set the focus until it becomes clear, and then press the shutter. Steadily the camera and take a photograph at a shutter speed of 1/125 sec.
∞E (blinking)	The aperture adjustment ring on the lens is not set to the minimum aperture value.	Turn the aperture adjustment ring to set it to the minimum aperture value. (F22)
Automatic focusing does not work properly.	A manual focusing lens has trouble with automatic focusing.	Use the focusing ring to adjust the focus.
Dark or too bright pictures	Inappropriate exposure	Adjust the aperture adjustment ring accordingly.
The camera flash is not functioning.	The non-CPU lens may not be compatible, depending on the camera. This lens corresponds to the Nikon AF-P lens.	See the camera manual. See the camera manual or flash manual. This lens is not a "Digital" lens which relays distance information to the camera.
The camera finder indication or the display does not display.	This lens does not have an electric control signal, so there is no communication with the camera through electric signals.	No problem with shooting.
Zooming failure	This lens is a single lens.	No problem with shooting.
This lens cannot be mounted on other cameras.	This lens is designed for its own mount.	Purchase the designated lens mount.
You want to attach our 2X or 1.4X converter lens.	Our converter is designed for the T (M42) lens mount only. Therefore it cannot be used with the 16 mm F2.0 ED AS UMC CS lens.	Use each company's own mount converter. However, be aware that auto focusing is unavailable.

10. Safety Precautions

<p>The following precautions are divided into two types according to the level of danger.</p> <p>WARNING If this instruction is not followed, it may cause death or serious injury to the user.</p> <p>CAUTION If this instruction is not followed, it may cause death or serious injury to the user.</p>	<p>The following pictograms are used in the below precautions.</p> <p>⚠️ Means caution. Inside the pictogram, it shows contents of precautions. ⚡ Means electrical shock or fire prevention on the lens.</p> <p>🚫 Means prohibition. Inside the pictogram, it shows contents of prohibition. ⚠️ Means prohibition of damaging the program or the lens. 👤 Means restriction of operation (if the pictogram or the lens).</p>
<p>WARNING</p> <p>⚠️ Don't look at the sun through the lens. If it may cause blindness.</p> <p>⚠️ Don't leave the lens within reach of children. If it may cause injury to the baby if the lens falls or is dropped.</p>	<p>CAUTION</p> <p>⚠️ Attach the lens to the camera correctly and ensure the lens is held in place properly. Otherwise, the lens may be removed, scratched, or may become loose. Please use an appropriate force when attaching the lens.</p> <p>⚠️ Don't put excessive pressure on the lens attached to the camera. Otherwise, it may cause damage to the lens or become loose. Please use an appropriate force when attaching the lens.</p> <p>⚠️ Don't leave the lens in a hot or cold place, or in direct sunlight, or in a place where it is exposed to light on a close object.</p>
<p>⚠️ Don't touch the lens with your fingers. If it may cause scratches or damage to the lens.</p> <p>⚠️ Don't attempt to modify or repair the lens. If any damage occurs, please contact the nearest service center.</p>	<p>⚠️ Ensure that the camera use mode is properly checked by the camera manual or the lens manual.</p> <p>⚠️ Don't look at the sun directly through a camera with a lens attached. If it may cause eye injury.</p>

WARNING!
Do not wet this product or expose it to a moist environment. It may cause a fire or electric shock.

- CAUTION!**
- Do not use this product or store it close to devices that generate heat i.e., heaters, thermal regulators, stoves or stereo amplifiers.
 - Do not leave the lens in conditions where drastic temperature changes can occur.
 - Do not touch the surface of the lens by hand, and avoid making contact with sharp objects.
 - Avoid dropping the lens.
 - Do not soak the lens in water, and avoid water splashing onto the lens.
 - If there are foreign bodies on the lens, use a lens cleaning kit only.

MEMO

MEMO

MEMO

MEMO