

About Traxon e:cue

Traxon (based in Hong Kong) together with its light management platform brand, e:cue (based in Paderborn, Germany), is a global leader in dynamic lighting.

As a 5-time winner of the ISA Global SSL Awards, Traxon e:cue transform creative visions into unforgettable lighting experiences, elevating smart city, architectural, entertainment, hospitality, commercial and industrial environments around the world.

e:cue provides intelligent, intuitive lighting management systems for dynamic, medial and functional lighting control. We provide all the necessary tools to orchestrate any kind of project, from controlling a single room installation up to managing an entire city-wide lighting infrastructure using one central platform.

Working with our extensive network of global partners, we intensify the entertainment factor, boost your city's hospitality potential, and enhance retail environments.

Ultimately, our comprehensive solutions emphasize architectural grandeur when it comes to city beautification. Our customers and partners are sparkling cities; leading international lighting designers, architectural and engineering firms; and the world's premier developers and brands. Together, we have completed over 7,000 installations worldwide, including renowned architectural landmarks.

In 2009, Traxon Technologies entered a joint venture with OSRAM, a partnership which ultimately led to OSRAM's complete acquisition of Traxon in 2011, thus strengthening our position in the market by combining knowledge and experience in technology and marketing and building on synergies with OSRAM's global presence.

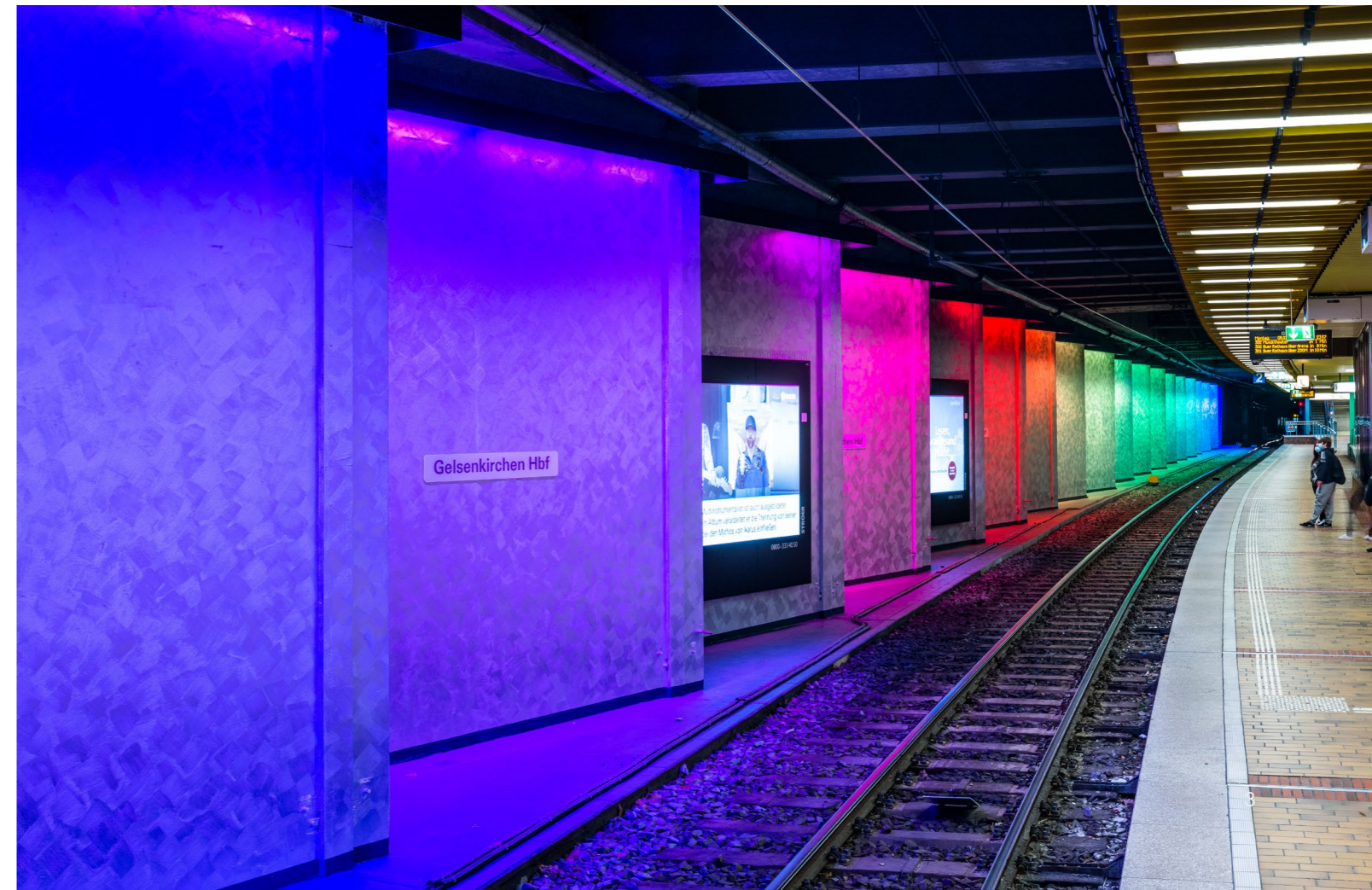

Smart Beautiful Cities

Smart Beautiful Buildings

Smart Beautiful Experiences

Traxon e:cue connects and illuminates cities around the world.
In conjunction with our technology, partners and professional networks we:



Photo: Holm Basedow, © Atelier SHA

Change the look of a city with the push of a button
Attract business by creating a smart and beautiful environment. Captivate tourists by delivering mind-blowing experiences. Establish creative spaces that stimulate innovations. Offer inspirational environments that draw attention from the most talented people. The look of a city can be switched as easily as changing a TV channel. Create seasonal atmospheres, backdrops for city events, and new tourist destinations. Facades of buildings, landscape lighting, streetlights and even office lights can be integrated into one symphony of light.

Make your properties and businesses stand out
Set your property apart from the competition. Entice the most fascinating and promising tenants of the future. Give back a piece of art to your city. An edifice becomes a part of the symphony of light and interaction. It elevates its surroundings to higher standards. It attracts new visitors hence customers for businesses. Buildings and their environs are positioned as state-of-the-art

areas. Businesses, guests and residents can experiment with visual effects and interactivity to create new business opportunities.

Create inspirational environments for everybody
Let the locals participate in shaping their environment. Enhance safety and security. Promote creativity. Using interactive applications, residents and guests can change the looks of buildings and even alter the visual characteristics of the city. Play video games on facades that operate as screens. Incorporate visual art to communicate or trigger messages by approaching the building. Create an inspirational environment in which every member of society can be an active participant.

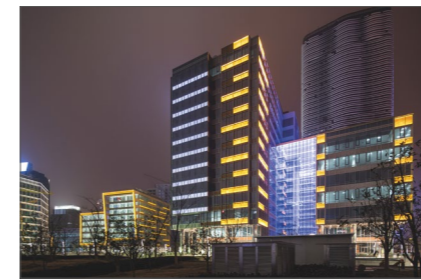

A citywide network

We integrate new or existing buildings and objects in in a central lighting system network.

- Historical buildings
- Statues
- Offices Buildings
- Parks
- Fountains
- Stadiums
- Shop Windows



From elegant lighting to expressive media experiences

Subtle lighting moods, moving color effects, perfect white light or dynamic video content:

- Static or dimmed lighting
- White or Dynamic White scenes
- Colorful experiences
- Multimedia displays



Interaction for all

Create experiences where inhabitants and visitors can communicate and interact with a dynamic beautiful environment.

- The lighting communicates with smart devices
- Video games are played on facades
- Businesses send promotions to visitors in close proximity
- The lighting enables guided tours

Product solutions



Traxon Luminaires

- Illumination (outdoor and indoor)
- Media and Facade Solutions
- Ambience and Accent Lighting

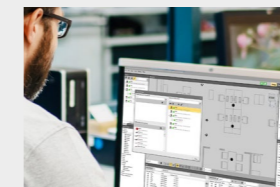

SYMPHOLIGHT

- System integration
- Content creation
- Creation of work processes
- Automation
- Interactivity

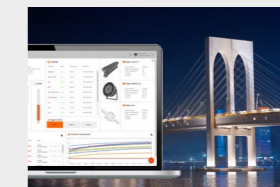

SymphoCity

- Manage
- Monitor
- Reporting
- Content Management
- Centralized Control



SYMPL Range

- Dynamic light management
- Functional light management (DALI)
- Modular and scalable
- Supports major standards and protocols

Our commitment to you

Traxon e:cue transform creative visions into unforgettable lighting experiences, elevating architectural structures around the world. We believe that the phrase „complete solutions“ encompass more than just a product portfolio; the solution starts with the first creative spark. Our team of outstanding professionals, together with our global partner network, will guide you through each project phase. From creative ideas and selecting the best system to communicate your vision, to post-installation communication, our worldwide project management, planning, and support services, are yours throughout the process. The age of dynamic digital lighting is here; you can be part of the revolution. We invite you to partner with us for your next architectural lighting project.



Your light. Our passion.

Traxon e:cue sets new standards for innovation in professional lighting through custom-designed and performance-driven fixture solutions, delivering unforgettable lighting experiences for a sustainable and energy-efficient world.

e:cue SYMPHOLIGHT

SYMPHOLIGHT – the ultimate solution to manage and control any type of lighting project. Easy, Intuitive and scalable from a single room installation up to an entire city – one software for all!

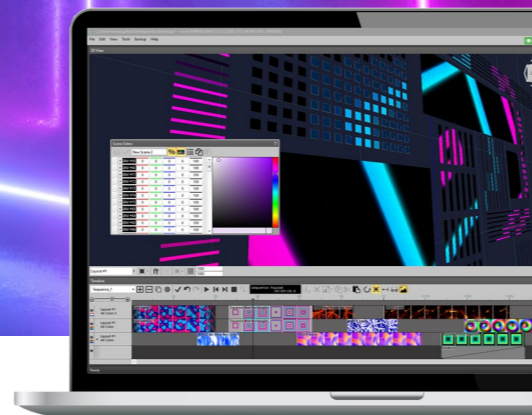

NEW: Live Video-IN
Use external or live video sources in your projects like USB-cameras, capture cards or virtual screens. The application of your own video software or camera is no longer a concern.



NEW: Art-Net and sACN Output
SYMPHOLIGHT is now even more flexible with the support of standardized third party protocols. This generates numerous new application options usable in all projects with LCE down to the Core S level!



Dynamic content!
Instantly create stunning lighting sequences, scenes or animations with any type of monochrome or dynamic color fixtures. The Timeline-based approach enables intuitive and easy to follow programming.



2x winner of the ISA Global SSL Award of Innovations Top 100 2021!



Functional lighting!
We have developed a completely new approach for handling DALI, DT6, DT8, monochrome, DW, RGB and RGW fixtures. Monochrome, DW, RGB, RGBW. Any need to handle DALI v2 devices in your project? SYMPHOLIGHT 5.3 helps to unlock the full potential! Check out Page 14!



Commissioning & Setup!
SYMPHOLIGHT provides all the needed tools and functionality to ensure a professional project setup. Good preparation is the key for success. Start with a small setup and grow with your project demands – fully flexible.

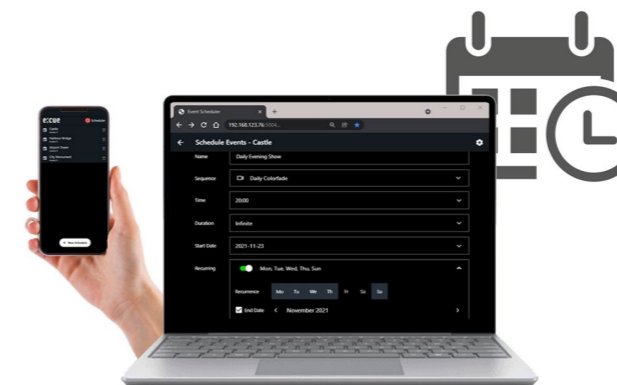

NEW: SYMPHOLIGHT Scheduler
Simply schedule start and end times of lighting scenes or sequences without sophisticated programming knowledge – direct access via web or mobile app for any logged in user. Plan single one time or recurring events, days, months, years or consecutive days.

Lighting Application Suite (LAS)
The e:cue Lighting Application Suite is a collection of different software applications to model and create the most dynamic lighting designs. It includes innovative and intuitive tools to design simple to complex lighting and multimedia scenarios, along with show control features, sound2light and moving lights support.

More infos: www.ecue.com

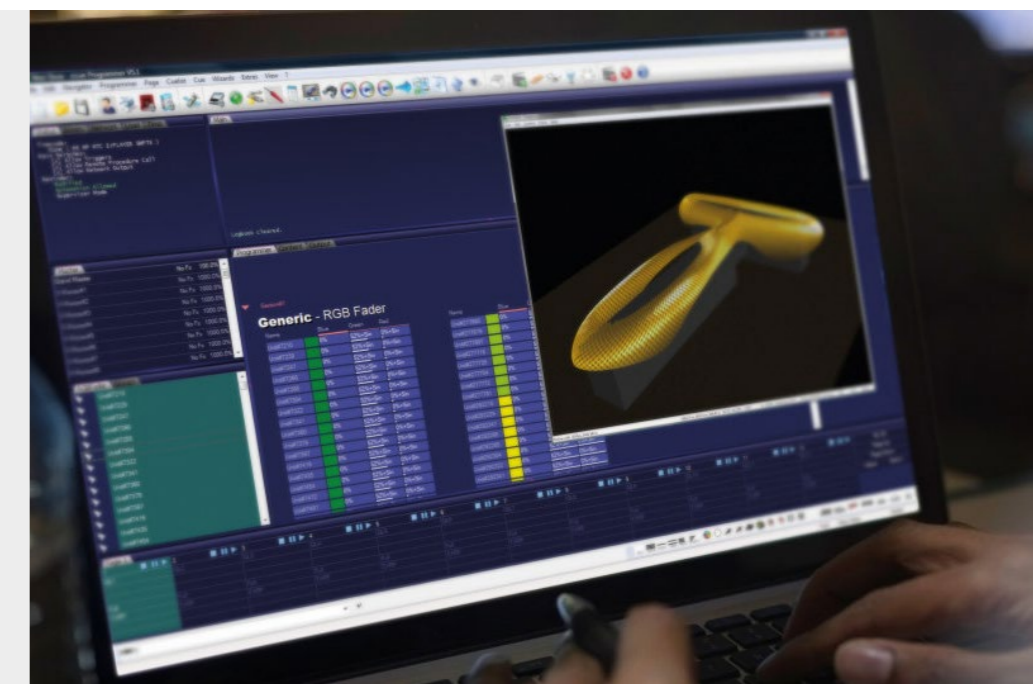

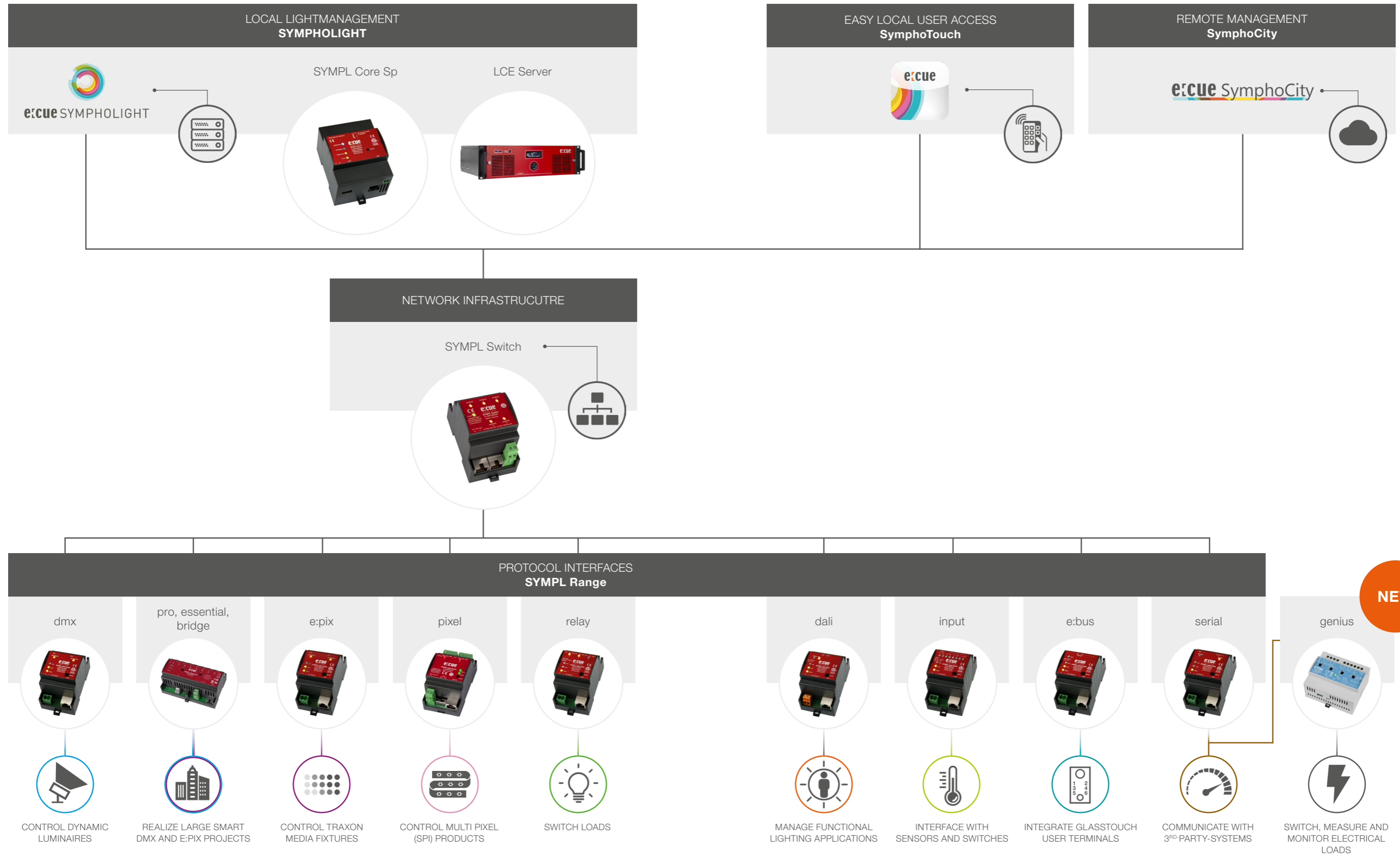

System Overview



SYMPL

Product	Key Features	Specs
 SYMPL dmx Node 2-port DMX and RDM interface for the use with SYMPHOLIGHT or LAS IC: AB444180035	<ul style="list-style-type: none"> 2 x DMX512/RDM outputs Test mode via Button for easy commissioning DMX Snap Shot can be recorded with SYMPHOLIGHT and played in case of failure Webinterface for configuration 	<ul style="list-style-type: none"> 1 x e:net 10/100 Mbit/s RJ45 2 x DMX512/RDM, individually isolated 3-pin terminal plug 53.5 x 90.5 x 62mm, 100g
 SYMPL e:pix Node 2-port DMX and e:pix interface for the use with SYMPHOLIGHT IC: AB443930035	<ul style="list-style-type: none"> 2 x e:pix or DMX outputs Up to 4096 channels with e:pix Test mode via Button Web interface for easy commissioning 	<ul style="list-style-type: none"> 1 x e:net 10/100 Mbit/s RJ45 2 x e:pix, individually isolated 3-pin terminal plug 53.5 x 90.5 x 62mm, 100g
 SYMPL dali Node DALI interface with integrated bus power supply for the use with SYMPHOLIGHT IC: AB444230035	<ul style="list-style-type: none"> One DALI line for the communication with Ballast and Sensors and user-interfaces Supports the communication with DALI version 2 devices Web interface for easy commissioning Test mode via Button 	<ul style="list-style-type: none"> 1 x e:net 10/100 Mbit/s RJ45 1x DALI line, conformal to EN 62368-101 53.5 x 90.5 x 62mm, 100g
 SYMPL input Node 8 port analog input interface for the use with SYMPHOLIGHT IC: AB444200035	<ul style="list-style-type: none"> Eight analog inputs for 0 ... 10 V four of them switchable to 0 ... 20 mA for the use with special sensors such as Temperature Web interface for Configuration Easy way to add inputs or outputs devices to SYMPHOLIGHT project 	<ul style="list-style-type: none"> 1 x e:net 10/100 Mbit/s RJ45 8 x analog inputs 0 ... 10 V, 4 of them switchable to 0 ... 20 mA 53.5 x 90.5 x 62mm, 100g
 SYMPL serial Node RS-232 and the RS-485 interface for the use with SYMPHOLIGHT IC: AB444220035	<ul style="list-style-type: none"> Two serial interfaces 1 xRS232 1 x RS485 Web interface for Configuration 	<ul style="list-style-type: none"> 1 x e:net 10/100 Mbit/s RJ45 2 x serial interfaces on 3-pin terminal plug 53.5 x 90.5 x 62mm, 100g
 SYMPL relay Node 3 port relay output for the use with SYMPHOLIGHT IC: AB444190035	<ul style="list-style-type: none"> Three relay outputs SPDT for up to 5 A/250 V AC or 3 A/30 V DC Simple integration of non intelligent lighting fixtures into SYMPHOLIGHT Test mode via Button Web interface for easy commissioning 	<ul style="list-style-type: none"> 1 x e:net 10/100 Mbit/s RJ45 3 x SPDT relays, 3-pin terminal plug wire gauge: 0.21 ... 3.31 sqmm 53.5 x 90.5 x 62mm, 125g
 SYMPL e:bus Node Interface with up to 8 wallmount touch devices (Glass Touch) and SYMPHOLIGHT IC: AB444210035	<ul style="list-style-type: none"> e:bus interface to connect up to 8 e:bus devices (Glass Touch) in your SYMPHOLIGHT System Web interface for Configuration 	<ul style="list-style-type: none"> 1 x e:net 10/100 Mbit/s RJ45 1 x e:bus on 2-pin 53.5 x 90.5 x 62mm, 100g
 SYMPL pixel Node 2 port interface to control a wide range of synchronous and asynchronous (SPI) serial addressable LED pixel via SYMPHOLIGHT IC: AM390290035	<ul style="list-style-type: none"> 2 x Output for Pixel Control with up to 2048 Channel each Output a wide range of asynchronous and synchronous (SPI) protocols Alternatively usable as 2 x DMX512 output Power input via external PSU, PoE or directly from a connected fixture Long range cabling up to 300 meters via the Pixel Range Extender (Accessory) possible Web interface for Configuration Test mode via Button for easy commissioning 	<ul style="list-style-type: none"> 1 x e:net 10/100 Mbit/s RJ45 2 x 4pin terminal plug 53.5 x 90.5 x 62mm, 80g
2x Pixel Range Extender: IC: AM394020035	<ul style="list-style-type: none"> Supported chips: APA104_400, APA104_800, TM1804_400, TM1804_800, TM1812, UCS2903, UCS2904, UCS8903_16bit, UCS8904A_16 bit, WS2811_400, WS2811_800, WS2812, WS2812b, WS2813, WS2818, WS2801, APA102 / APA102c, DMX512, other up on request 	
More details on page 16		

SYMPL

Product	Key Features	Specs
 SYMPL pro Node Smart DMX/RDM or e:pix controller for state-of-the-art lighting control projects. Specially designed for rough environments IC DMX Version: AM255360031 IC e:pix Version: AM305690031	<ul style="list-style-type: none"> 8 outputs for DMX512/RDM or e:pix (dependent on model) Extended operating temperature (-40...70°)* Isolated outputs up to 3,75kV Integrated protection against surge (Level 3) Embedded temperature & humidity sensors Reverse polarity protection Backup-mode on data loss Power-over-Ethernet Test mode access via button for easy commissioning Protection against miswiring 	<ul style="list-style-type: none"> 1 x e:net 10/100 Mbit/s RJ45 8 x DMX512/RDM/e:pix via 3-pin terminal plugs 143 x 92 x 62mm, 250g
 SYMPL essential Node Smart DMX controller for state-of-the-art lighting control projects. Specially designed with tough outdoor environments in mind Designed for DMX512 Projects only IC: AM305670031	<ul style="list-style-type: none"> 8 x DMX512 outputs (no RDM) Extended operating temperature (-40...70°)* Isolated outputs up to 3,75kV Integrated protection against surge (Level 3) Reverse polarity protection Backup-mode on data loss Power-over-Ethernet Test mode access via button for easy commissioning Protection against miswiring 	<ul style="list-style-type: none"> 1 x 10/100 Mbit/s RJ45 for e:net 8 x DMX512 via 3-pin terminal plugs 143 x 92 x 62mm, 250g
 SYMPL bridge Node 8 port e:net, sACN/Art-Net to DMX interface grants full access to Traxon fixtures via the e:pix protocol via any 3 rd -party controller utilizing Art-Net or sACN with up to 32 Universes IC: AM356970031	<ul style="list-style-type: none"> 8 x DMX512 / e:pix outputs Extended operating temperature (-40...70°)* Isolated outputs up to 3,75kV Supports up to 32 Art-Net / sACN universes via e:pix Switch between two input sources (SYMPHOLIGHT, Art-Net, sACN) Backup-mode on data loss (via SL) Integrated protection against surge (Level 3) Reverse polarity protection Power-over-Ethernet sACN in unicast or multicast mode Protection against miswiring 	<ul style="list-style-type: none"> 1 x 10/100 Mbit/s RJ45 for e:net / Art-Net / sACN 8 x DMX512/e:pix, via 3-pin terminal plugs 143 x 92 x 62mm, 250g

*) 70 °C / 158 °F for max. 1 hour/day; continuous operation at max. 60 °C / 140 °F.

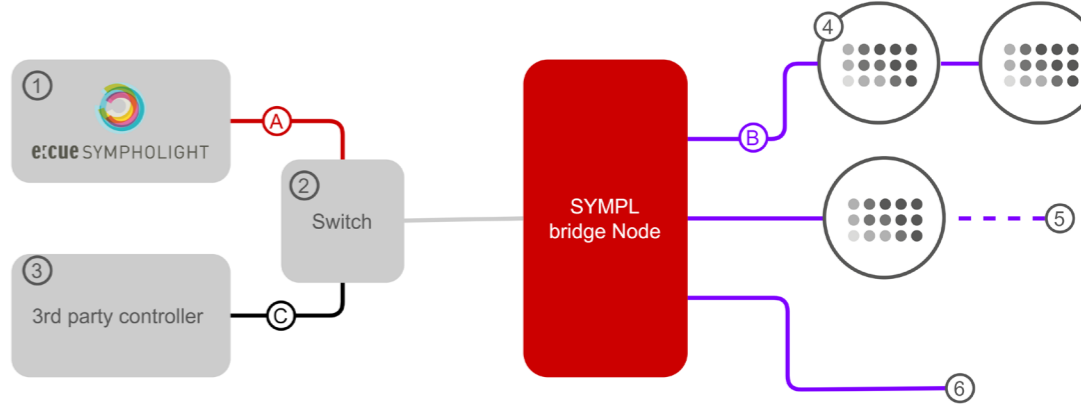

The diagram illustrates the SYMPL bridge Node's connectivity. On the left, it connects to 'e:cue SYMPHOLIGHT' (labeled 1) and a '3rd party controller' (labeled 3) via an 'e:net' connection (labeled A). The bridge node is connected to a 'Switch' (labeled 2). From the switch, it connects to 'e:pix DMX out' (labeled B) which feeds into the SYMPL bridge Node. The bridge node then outputs to multiple 'e:pix or DMX fixture' (labeled 4) and 'Up to 2048 channel per output (e:pix)' (labeled 5). A total of 8 outputs (labeled 6) are shown.

A) e:net (ethernet based protocol)
 B) e:pix DMX out, up to 150m (200m) length with CAT5 cable
 C) Art-Net or sACN (ethernet based protocol)
 1) Software, running on LCE server or Core S
 2) SYMPL Switch or other network switch
 3) Art-Net or sACN controller
 4) e:pix or DMX fixture
 5) Up to 2048 channel per output (e:pix)
 6) 8 outputs in total

DALI lighting control

Manage functional lighting like never before!



Our tools



SENSING

Motion, brightness, humidity temperature and other environmental factors



HCL

Increase productivity and well-being. Improve focus and concentration



SWARM CONTROL

Always the best lighting conditions around you



INTEGRATE COLORS

Via DALI (DT-8) or any other dynamic lighting fixture controlled out of one single system



INTERFACING

We offer several ways to interact with 3rd-party devices, protocols or building management systems



SCHEDULE LIGHT

Your desired lighting at the right time



SAVE ENERGY

Smart time scheduling, daylight harvesting and occupancy control



ALWAYS IN CONTROL

Real-time control of all parameters changeable at any time. Users can create personalized control interfaces via app or web browser based on their needs



- All-in-one solution for lighting control and management - Fully scalable via ethernet
- Fast commissioning of all devices - simply edit ballast scenes
- Enhanced testing functionality and easy device replacement
- Control DALI, DMX, relays, analog sensors and more
- Support for the most common types of ballasts & DALI v2 sensors and couplers
- Combine functional lighting with dynamic DMX sequences in one software/System

Maximum flexibility with DALI v2 support

e:cue SYMPHOLIGHT 5.3 comes with full support of DALI v2 input devices. This enables a manufacturer-independent and future-proof planning according to tender requirements. Besides new interaction possibilities through additional supported device types, the extended address space on the DALI line offers additional flexibility.

> Check ecue.com



Smart solutions

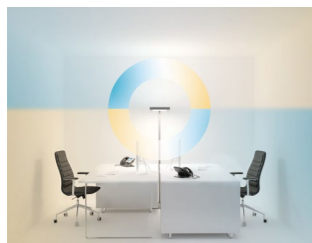

Office



Education

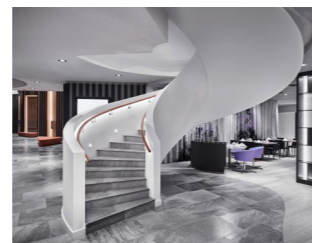

Hospitality and Museum



Industry



Did you already know?

e:cue is now offering complete solutions for sensing environmental data such as brightness, humidity, temperature, motion and presence. Sensors from different manufacturers can be integrated into SYMPHOLIGHT via DALI v2. We are happy to assist you together with our partners and provide you with the best sensor solution for your project.

SYMPL pixel Node

NEW





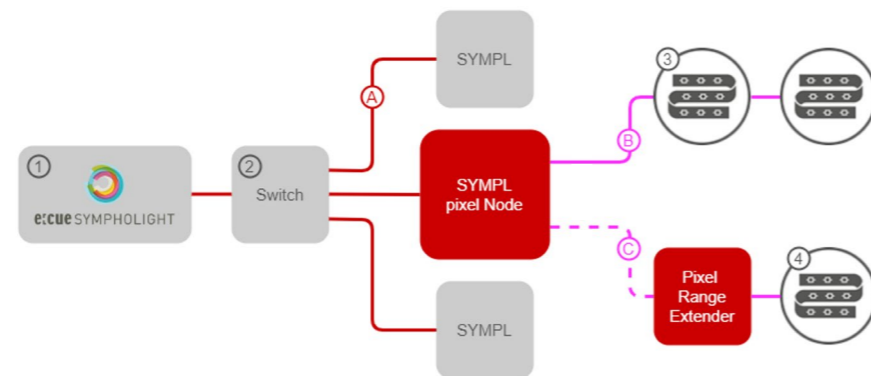

e:cue's new LED pixel controller supports various serial addressable LED pixel products like strips, dots and boards with individually controllable pixels. It can control a wide range of asynchronous and synchronous protocols (SPI).

- Controls up to 2048 pixel channels per output (= 682 RGB or 512 RGBW pixels)
- Support for 512 DMX channels per output (= 170 RGB pixels)
- Power Input via external PSU, PoE or directly from the connected fixture.
- Long range cabling up to 300 meters via the Pixel Range Extender (Accessory) possible
- Supported Protocols: APA104_400, APA104_800, TM1804_400, TM1804_800, TM1812, UCS2903, UCS2904, UCS8903_16bit, UCS8904A_16 bit, WS2811_400, WS2811_800, WS2812, WS2812b, WS2813, WS2818, DMX512, WS2801, APA102 / APA102c, other up on request



- A) e:net (ethernet based protocol)
 B) 2x Outputs up to 3m wiring length
 C) Up to 300m wiring length (differential signal) with shielded, twisted pair cable, e.g. CAT
 1) Software, running on LCE server or Core S
 2) SYMPL Switch or other network switch
 3) Pixel lighting fixture
 4) Any supported asynchronous pixel lighting fixture



Server

Product	Key Features	Specs
 SYMPL Core S & Sp Stand-alone engine for e:cue SYMPHOLIGHT with SYMPL Nodes functioning as interfaces IC Core S: AB447060035 IC Core Sp: AM430280035	<ul style="list-style-type: none"> – SYMPHOLIGHT engine for small to medium-sized projects – Connections to SYMPL Nodes via Ethernet (scalable) – SYMPHOLIGHT ActionPad as user interface suitable with all standard web browsers – Micro SD card for storage of show files and content or by using SYMPHOTOUCH APP – Power over Ethernet (Core Sp only) – Webinterface for configuration and monitoring 	<ul style="list-style-type: none"> – Max. Performance Dynamic: Up to 5.000 RGBW or RGB Pixel with SYMPHOLIGHT – Max. Performance DALI: 256 Ballast, 64 Dali Groups (Virtual), 42 Dali Button
 Lighting Control Engine 2 mx High Performance reliable control server for medium-sized projects IC: AM193980031	<ul style="list-style-type: none"> – Equipped with e:cue's SYMPHOLIGHT and LAS – Fanless operation, no moving or rotating parts – High quality components for reliable uninterrupted operation, certified for industrial use – Supports headless operation (no monitor and keyboard needed) 	<ul style="list-style-type: none"> – Max Performance Dynamic: 50.000 RGBW or RGB Pixel with SYMPHOLIGHT, 10.000 RGBW or RGB Pixel with LAS – Max Performance DALI: 512 Ballast, 64 Dali Groups, 84 Dali Button, 84 Sensors
 Lighting Control Engine 3 19" rack-mountable high performance control server for any demanding Project guarantee uninterrupted operation IC: AM368100035	<ul style="list-style-type: none"> – Equipped with e:cue's SYMPHOLIGHT and LAS – High quality industrial components for reliable uninterrupted and efficient 24/7 operation – 2x SSD hard disk drive in RAID 1 operation for increased system stability – Integrated dry contact inputs (6x) and relay outputs (2x) – LC display and cursor keys for status messages – 19" rack-mountable (3U) 	<ul style="list-style-type: none"> – Max. Performance Dynamic: 3.000.000 RGBW or RGB Pixel with SYMPHOLIGHT, 10.000 RGBW or RGB Pixel with LAS – Max. Performance DALI: 3072 Ballast, 128 Dali Groups, 168 Dali Button, 168 Sensors
 Lighting Control Engine 3 (fx) Similar to the Lighting Control Engine 3 but with extended real-time video manipulation tools IC: AM368100135	<ul style="list-style-type: none"> – Equipped with e:cue's SYMPHOLIGHT, LAS and EmotionFX Video manipulation Software – High quality industrial components for reliable uninterrupted and efficient 24/7 operation – 2x SSD hard disk drive in RAID 1 operation for increased system stability – Integrated dry contact inputs (6x) and relay outputs (2x) – LC display and cursor keys for status messages – Integrated Video Capture Card – 19" rack-mountable (3U) 	<ul style="list-style-type: none"> – Max. Performance Dynamic: 3.000.000 RGBW or RGB Pixel with SYMPHOLIGHT, 10.000 RGBW or RGB Pixel with LAS – Max. Performance DALI: 3072 Ballast, 128 Dali Groups, 168 Dali Button, 168 Sensors



Network

Product	Key Features	Specs
 SYMPL Switch Ethernet switch for up to 5 devices with PoE IC: AM313830035	<ul style="list-style-type: none"> – Five Ethernet ports – Power over Ethernet (PoE) for all ports when using 48V – Classic Switch (without PoE) when using 24V 	<ul style="list-style-type: none"> – 5 x e:net 10/100 Mbit/s RJ45 – PoE-Ports Mode B (PoE over spare wires) – According to IEEE802.3af – 53.5 x 90.5 x 62 mm, 80g

Dimmer



Product	Key Features	Specs
 <p>DMX2CC Dimmer DMX512 control of High Power LEDs using constant current dimming, ensuring flickerfree and smooth dimming. IC: AA57005011L</p>	<ul style="list-style-type: none"> DMX512 in/out with auto/manual addressing options Pre-selectable LED current between 50 mA to 700 mA Flicker-free smooth fade control with continuous current output High efficiency (up to 95%) LCD menu for manual control Self-diagnostic feature prevents damage to the unit and to the LEDs Line, thermal and circuit protection 	<ul style="list-style-type: none"> 1 x DMX512 (RJ45) Power 24-48 VDC max. 4.5A 12 output channels (screw terminals) 272 x 75.4 x 58.5mm, 750g
 <p>DMX2PWM DMX control of 3 or 9 channel low-voltage LEDs using PWM (Pulse-Width Modulation) and constant voltage dimming. IC 3Ch: AA623900135 IC 9Ch: AA623910135</p>	<ul style="list-style-type: none"> LED dimming using pulse with modulation (PWM) For use with constant voltage fixtures 3/9 outputs individually controllable via DMX Auto or manual addressing Low side switching Reverse supply protection 14 bit PWM resolution Overcurrent protection (self resetting) 	<ul style="list-style-type: none"> 1 x DMX512 (RJ45) 1 x DMX512 (RJ45) Daisy Chain Input voltage range: 12 ... 48 VDC Max. output current of 2.5 A per channel (3Ch.) and 2A (9Ch.) 3 or 9 screw terminals connector 3Ch: 94 x 71.5 x 24mm, 80g 9Ch: 107 x 76 x 59mm, 228g

Converter

Product	Key Features	Specs
 <p>DMX2DALI DMX to DALI converter allows the integration of DALI fixtures in DMX controlled surroundings IC: AA761550027</p>	<ul style="list-style-type: none"> 6 DALI (Broadcast) outputs = 6 DMX Channel Up to 16 DALI ballasts per output Power and DMX status LEDs Manual and auto DMX addressing modes (DIP switches for configuration) User selectable number of DMX channels (1-6) Direct power supply of each DALI output 	<ul style="list-style-type: none"> 1 x DMX512 (RJ45 & spring terminal clamps) 1 x DMX512 (RJ45 & spring terminal clamps) for daisy chain 6 x DALI (spring terminal clamps) Single 100 to 240 V AC supply voltage 107 x 76 x 59mm, 300g
 <p>Bridge 8 8 port sACN/Art-Net to DMX Interface specially designed for rough environments IC: AM356960031</p>	<ul style="list-style-type: none"> 8 outputs for DMX512 Extended operating temperature -40° - 70° C* Isolated outputs up to 3.75kV Integrated protection against surge (Level 3) Reverse polarity protection Test mode access via button Web interface for status and configuration Switch between two input sources sACN/Art-Net in unicast or multicast mode Protection against miswiring 	<ul style="list-style-type: none"> 1 x 10/100 Mbit/s RJ45 for sACN or Art-Net 8 x DMX512 3-pin terminal pug PoE (Power over Ethernet) 143 x 92 x 62mm, 259g

*) 70 °C / 158 °F for max. 1 hour/day; continuous operation at max. 60 °C / 140 °F.

User Terminals

Product	Key Features	Specs
 <p>Glass Touch T6 Sleek design with a glass surface, touch-sensitive keys for user interaction IC: AA439100138</p>	<ul style="list-style-type: none"> Sensor keys with status LEDs One on-off sensor Simple mounting via flush-mounted box Ultra thin design Sleek white glass front Connects via free topology e:cue e:bus (2-wire power and data connection) 	<ul style="list-style-type: none"> 6 capacitive touch sensors 1 capacitive on/off sensor 80 x 80 x 11mm, 110g
 <p>Glass Touch T12 Sleek design with a glass surface, touch-sensitive keys for user interaction. IC: AA439070138</p>	<ul style="list-style-type: none"> Sensor keys with status LEDs One on-off sensor Simple mounting in standard with in-wall fittings Ultra thin design Sleek white glass front Connects via free topology e:cue e:bus (2-wire power and data connection) 	<ul style="list-style-type: none"> 12 capacitive touch sensors 1 capacitive on/off sensor 80 x 160 x 11mm, 210g



Genius

Multifunctional solution for load switching, energy monitoring and power measuring combined in a single device

Are you a Genius? Make your light installation even smarter

- Makes standard luminaire/Load switching projects more smart
- Real-time monitoring of critical installations/objects
- Available in 4 or 8 channel version
- Switch up to 20A (resistive load) per channel
- Operating voltage 110V-250V
- Communication via Modbus RTU / ASCII
- Daisy chain up to 30 devices
- Measures: Voltage, current, power (active, apparent, reactive), power factor, energy (active), phase, line frequency
- Measurement tolerance +-3%
- Din-rail mounting

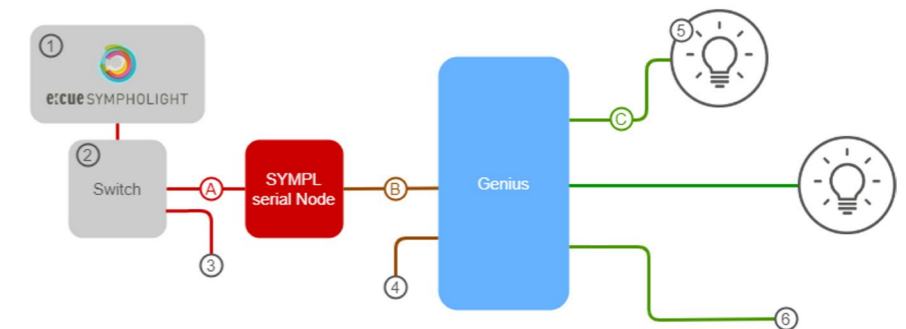

- A) e:net (ethernet based protocol)
- B) RS-485 wiring (Modbus)
- C) 200 ... 230 V AC / 20 A (resistive)
- 1) Software, running on LCE server or Core S
- 2) SYMPL Switch or other network switch
- 3) Multiple other SYMPL Node
- 4) Up to 32 Genius devices in Modbus daisy chain
- 5) Switch / measure load
- 6) Genius 4CH: 4 outputs in total, Genius 8CH: 8 outputs in total

Wallmount Controller



Product

LIGHTDRIVE+
DMX512 Wall-mount stand-alone controller with a sophisticated design. 8 keys and a jog wheel with color LEDs allow intuitive selection of colors and adjustment of intensity and speed.
IC: AB465960038

Key Features

- Standalone DMX controller
- Two DMX outputs for two DMX universes
- Two low-side switches (MOSFET relays)
- For monochrome, dynamic white, RGB and RGBW LED fixtures
- Eight predefined scenes
- Three predefined zones
- Proximity sensors
- Commissioning and programming via IOS/Android App (Summer 2022)
- For small to mid-size installations

Specs

- 12 capacitive touch keys
- 1 jog wheel
- Integrated Wi-Fi interface
- 80 x 160 x 30mm, 185g

Output Devices

Product



Butler S2
2-port DMX output device with RDM. Stand-alone functionality (Standalone with Lighting Application Suite - LAS only)
IC: AB436200031

Key Features

- Full RDM Support for bidirectional communication
- Stores and plays pre-programmed cue lists from LAS (up to 99 in standalone mode)
- Integrated web server for configuration

Specs

- 1 x 10/100 Mbit/s RJ45 for e:net
- PoE
- 2 x RJ45, USITT DMX512-A/RDM E1.20
- 71.5 x 24 x 85mm, 125g



Butler XT2
Advanced stand-alone controller for the use with the Lighting Application Suite - LAS
IC: AA557270131

- Up to 8 independently controlled zones in stand-alone mode
- Up to 1024 DMX512/RDM channels
- RDM for bidirectional communication
- Real-time and astronomical clock with daylight saving options
- Up to 16 systems (32 DMX512 universes) in stand-alone mode
- Integrated web server, remote control via App or special Windows Application
- Supports a connection with up to eight GlassTouch User Terminals

- 1 x 10/100 Mbit/s RJ45 for e:net
- 1 x e:bus (clamp terminals)
- 2x DMX/RDM (RJ45, clamp terminals)
- 1x Inputs RS-232 (clamp terminals)
- 8 optically isolated digital inputs
- 177 x 60 x 75mm, 400g



Butler Pro
DMX/RDM or e:pix Interface with 16 outputs in 19" format
IC DMX: AA628600035
IC e:pix: AA628610035

- 16 outputs for DMX512/RDM or e:pix (dependent on model)
- Backup-Mode
- Controls up to 8,192 DMX512/RDM channels (16 Universes)
- Up to 32,768 e:pix channels
- Highly flexible test options
- 19" rack-mountable

- 1 x 10/100 Mbit/s RJ45 for e:net
- 16 DMX/RDM/e:pix ports via RJ45
- USITT DMX512-A
- RDM ANSI E1.20
- 482 x 44 x 142mm, 1200g



Excite+
DMX input and output device for up to 512 DMX channels. LAS only.
IC: AA557280031

- USB-DMX interface
- 512 channel DMX output / input
- Gender changer for XLR5-pin male/female included
- Allows remote control of e:cue Programmer via external DMX signal

- 1 x USB 2.0, standard plug to Neutrik, XLR5f
- 200cm, 210g

e:cue Academy

Guarantees the best knowledge transfer and exchange! Find the right training model that fits your needs at ecue.com



SYMPHOLIGHT Basic Training

Learn how to use SYMPHOLIGHT in your own projects. Our training sessions typically start with a general software and system overview followed by configuration examples of our SYMPL Nodes and control networks. At the end of the session, you will be able to program an entire project alone. As a participant you will work with DMX, DALI, inputs and outputs. Inside SYMPHOLIGHT you will configure protocols/connections and automate them with the Workflow Designer.

SYMPHOLIGHT Advanced Training

The training is driven by the participants, e:cue experts will answer questions from all aspects of SYMPHOLIGHT.

> Check out for more information and registration: ecue.com

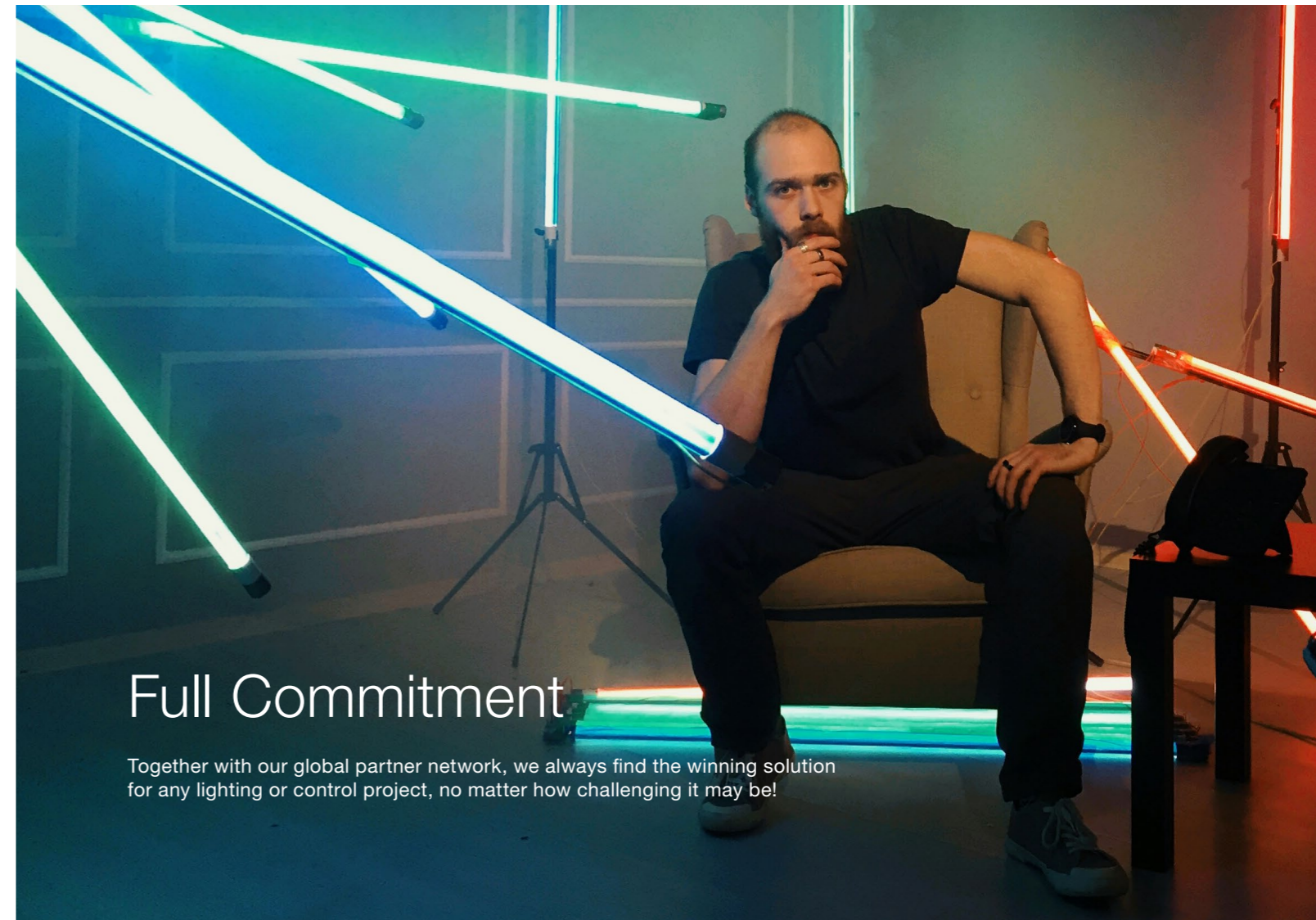

Full Commitment

Together with our global partner network, we always find the winning solution for any lighting or control project, no matter how challenging it may be!

traxon e:cue





ProPoint Kontour

The ProPoint Kontour is a multi pixel dynamic accent luminaire for outlining and highlighting facades, walls, architectural borders

The ProPoint Kontour series is an AC line powered dynamic accent luminaire designed for outlining and highlighting facades, walls, architectural borders and bridges.

It is controllable via DMX512 and connected using a Data Injector which combines power and data into one simple daisy chain topology.

It can achieve long run lengths up to 1000ft (~300m) on a single white power/data run at 277V and 800ft (~240m) at 220-240V.

The ProPoint Kontour comes in 2 different widths and 4 lengths offering RGBW, RGB, 3000K and 4000K White as standard options.

Key Features

- 300mm Pixel Pitch
- 2 different widths
- 2 different diffuser shapes: Flat/Round
- 4 different lengths: 300/600/1200/2400mm
- AC Universal Voltage
- DMX Controlled
- Auto Addressing
- Long run lengths up to 240m

Colour Options

- RGBW (W: 6500K)
- RGB
- 3000K
- 4000K



Above: ProPoint Kontour 1200mm Flat Wide
Below: ProPoint Kontour 1200mm Round Narrow

Ambience and accent

Product	Colour	Optic	Key Features
 Cove Light AC DIM GII 5W / 8W / 12W per 300mm 300mm x 37mm x 55mm 1200mm x 37mm x 55mm IP20 INDOOR 230 VOLT AC	<ul style="list-style-type: none"> - 2700K - 3000K - 3500K - 4000K 	- 120°	<ul style="list-style-type: none"> - SDCM 2 - CRI >80Ra - 1-10V Dimming - CE - ±90° Tilt Adjustment - 509lm - 5145lm - High efficiency 106lm/W - 120lm/W
 Cove Light AC HO RGBW HO-6 24 LED / 329lm HO-12 48 LED / 619lm HO-18 72 LED / 978lm 304mm x 39mm x 50mm 609mm x 39mm x 50mm 913mm x 39mm x 50mm IP20 INDOOR 230 VOLT AC DMX 512	<ul style="list-style-type: none"> - RGBW (W:3000K) 	- 120°	<ul style="list-style-type: none"> - DMX - 4 Channel control - ±90° Tilt Adjustment - Multi pixel version available
 ProPoint Kontour Flat 300mm / 600mm / 1200mm / 2400mm Narrow 46.5mm x 59.5mm x L Wide 75mm x 66mm x L IP66 COAST 110-277 VOLT AC 1 MOQ DMX 512 RDM	<ul style="list-style-type: none"> - RGB - RGBW - 3000K - 4000K 	- 120° Diffused flat lens	<ul style="list-style-type: none"> - AC Powered -Universal voltage 120 -277VAC - Long daisy chain connectivity - DMX controllable in 300mm sections or per luminaire - Factory customisable pixel pitch - IK08 (Narrow) or IK07 (Wide) /IP66 / ANSI C136.31 /3G Vibration Rating - Available in three different housing finishes: grey, white, black
 ProPoint Kontour Round 300mm / 600mm / 1200mm / 2400mm Narrow 47.4mm x 69mm x L Wide 75mm x 89.4mm x L IP66 COAST 110-277 VOLT AC 1 MOQ DMX 512 RDM	<ul style="list-style-type: none"> - RGB - RGBW - 3000K - 4000K 	- 100° x 125° Diffused Round lens	<ul style="list-style-type: none"> - AC Powered -Universal voltage 120 -277VAC - Long daisy chain connectivity - DMX controllable in 300mm sections or per luminaire - Factory customisable pixel pitch - IK08 (Narrow) or IK07 (Wide) /IP66 / ANSI C136.31 /3G Vibration Rating - Available in three different housing finishes: grey, white, black
 Flat Clear IP66 COAST 110-277 VOLT AC 1 MOQ DMX 512 RDM	ProPoint Pixel Flat: 146x80x120 mm Diffused Dome: 146x123x120 mm Diffused Drum: 146x117x120 mm Diffused Prism: 146x113x120 mm	<ul style="list-style-type: none"> - Flat Clear - Flat - Diffused - Dome - Drum - Prism 	<ul style="list-style-type: none"> - Universal Input Voltage: 120-277vAC - IP66 and suitable for Coastal Environments - 20W output up to 678 lumens - Available in 3 Standard Finishes: Traxon Grey, Black, and White - 5 Optic Choices - DMX RDM controllable
 Flat Diffused	 Diffused Drum	 Diffused Dome	 Diffused Prism
 Large IP66 COAST 110-277 VOLT AC 1 MOQ	ProPoint Sconce Small 9W / Medium 15W / Large 24W Small: 153 x 122 x 106 mm Medium: 191 x 123 x 105 mm Large: 237 x 145 x 110 mm	- 10° x 5°	<ul style="list-style-type: none"> - Universal Input Voltage: 120-277vAC - IP66 and suitable for Coastal Environments - Available in 3 Standard Finishes: Traxon Grey, Black, & White - Available in 3 Wattage Outputs: 9W, 15W, 24W - DMX RDM controllable / On Off
 Medium	 Small		

Media

Product	Colour	Optic	Key Features
 <p>64 PXL Board 2.0 64 Pixel (8 x 8) 240mm x 240mm x 11.5mm</p> <p>IP20 INDOOR 24 VOLT DC DMX 512 E-PIX</p>	— RGB	— 115°	<ul style="list-style-type: none"> Pixel Pitch 31,25 mm TX Connect System Controlabe via DMX or e:pix Perfect for low resolution media projects Open Cover (IP20) Auto Addressing
 <p>16 PXL Board 2.0 16 Pixel (4 x 4) 230mm x 230mm x 11.5 mm</p> <p>IP20 INDOOR 24 VOLT DC DMX 512 E-PIX</p>	— RGB	— 115°	<ul style="list-style-type: none"> Pixel Pitch 62,5 mm TX Connect System Controlabe via DMX or e:pix Perfect for low resolution media projects Open Cover (IP20) Auto Addressing
 <p>16 PXL Strip 2.0 16 Pixel (1 x 16) 240mm x 15mm x 10 mm</p> <p>IP20 INDOOR 24 VOLT DC DMX 512 E-PIX</p>	— RGB	— 115°	<ul style="list-style-type: none"> Pixel Pitch 31,25 mm TX Connect System Controlabe via DMX or e:pix Perfect for low resolution media projects Open Cover (IP20) Auto Addressing Cutttable
 <p>Media Wall Paper 144 Pixel (16 x 16) 600mm x 600mm Can be cut to a minimum size of 300x200 mm</p> <p>IP20 INDOOR 24 VOLT DC E-PIX</p>	— RGB	— 115°	<ul style="list-style-type: none"> Pixel Pitch 50mm Flexible, can be cut into any shape Ultra-thin and ultra-lightweight Fast installation / low installation cost Bendable, perfect for Columns TX Connect with e:pix control
 <p>Media Tube® HO RGB/W 12PXL / 24PXL / 36PXL / 48PXL / 60PXL 12PXL 296mm x 23mm x 36mm 24PXL 596mm x 23mm x 36mm 36PXL 896mm x 23mm x 36mm 48PXL 1196mm x 23mm x 36mm 60PXL 1496mm x 23mm x 36mm</p> <p>IP66 COAST 48 VOLT DC DMX 512 E-PIX</p>	<ul style="list-style-type: none"> — RGBW (W: 6500K) — RGB 	<ul style="list-style-type: none"> — Direct View 110° — Diffused Dome 175° 	<ul style="list-style-type: none"> 25 mm RGBW pixel pitch Customisable pixel pitch (Consult sales for more information) Ultra-thin and ultra-lightweight Consistant colour regardless of audience's viewing angle and orientation +White intelligent algorithm, control RGBW pixels with 3 channels DMX / e:pix Daisy chain topology
 <p>Allegro Media Tube® Lite 3PXL / 5PXL / 10PXL Direct View: 300mm / 500mm / 1000mm x 24mm x 26mm Diffused View: 300mm / 500mm / 1000mm x 24mm x 40mm</p> <p>IP66 48 VOLT DC DMX 512</p>	<ul style="list-style-type: none"> — RGBW (W: 6500K) — RGB — DW (2700K - 6500K) 	<ul style="list-style-type: none"> — Direct View 110° — Diffused Dome 175° 	<ul style="list-style-type: none"> Slim profile 24mm and available in 3 different lengths Long daisy chain 12M RGBW / 17M RGB / DW Auto Addressing
 <p>Media Pixel Ribbon Indoor RGBW 8000mm x 12mm x 2mm RGB 8000mm x 12mm x 2mm DW 10000mm x 12mm x 2mm White 10000mm x 12mm x 2mm</p> <p>IP20 INDOOR 24 VOLT DC DMX 512</p>	<ul style="list-style-type: none"> — RGBW (W: 6500K) — RGB — DW (2700K - 6500K) — 4000K White — 3000K White — 2700K White 	<ul style="list-style-type: none"> — Direct View 120° 	<ul style="list-style-type: none"> CRI for White LED >80 CRI 10 Pixels per meter 100mm Pixel pitch Flexible media
 <p>Media Pixel Ribbon Outdoor RGBW 8000mm RGB 8000mm DW 10000mm White 10000mm</p> <p>IP67 24 VOLT DC DMX 512</p>	<ul style="list-style-type: none"> — RGBW (W: 6500K) — RGB — DW (2700K - 6500K) — 3000K White — 4000K White — 6500K White 	<ul style="list-style-type: none"> — Flat Clear — Flat — Diffused — Horizontal Bend — Vertical Bend 	<ul style="list-style-type: none"> Flexible media solution for creative media projects High flexibility for curve lighting and freeform application Complete control solution Cut-and-seal option IK08 (VB and HB), IP67

Allegro Media Tube® Lite

An IP66, slimline, pixel controlled linear tube for any wall or façade media lighting application.



The Allegro Media Tube® Lite has been designed to fit into any wall, façade or media lighting application with tight installation requirements.

With a wide beam angle output, a choice of direct view or diffused dome and 10-pixels-per-meter pixel resolution, this ensures a smooth illumination or media experience.

Featuring auto addressing and quick lock connectivity, plus long connection chains, this greatly simplifies the lighting installation for your application.

The Allegro Media Tube® Lite can be used for accentuating and for dynamic contouring of buildings, facades, structures and more, as well as for low and mid resolution media applications.

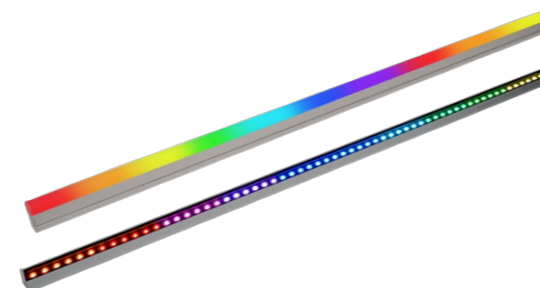

Above: Allegro Media Tube® Lite Diffused Dome
Below: Allegro Media Tube® Lite Direct View

Key Features

- 100mm Pixel Pitch
- 48V DC
- DMX Controlled
- Auto Addressing

Pixel Resolution

- 100mm Pixel Pitch
- 16.67mm LED Pitch

Colour Options

- RGBW (W:6500K)
- RGB
- Dynamic White (2700K-6500K)

Maximum Chain Length

- 12M RGBW
- 17M RGB
- 18M Dynamic White

Media



Product	Colour	Optic	Key Features
ProPoint Kontour Rhythm RGBW 64PXL	— RGBW (W: 4000K)	— 115°	<ul style="list-style-type: none"> — Omni bendable — 76mm Pixel Pitch — Customisable length — Customisable cable input/output — Customisable side/bottom/back cable entry — CRI ≥90 — White LED SDCM 3

IP67 24 VOLT DC PIXEL



Product	Colour	Optic	Key Features
Allegro Dot S: Direct Ø53x42x18 mm M: Direct Ø60x68x17 mm L: Direct Ø60x68x17 mm S: Diffused Ø53x42x27 mm M: Diffused Ø60x68x39 mm L: Diffused Ø60x68x39 mm	— RGB — RGBW (W:6500K)	<ul style="list-style-type: none"> — S Direct View 100° — M Direct View 110° — L Direct View 110° — S Diffused Dome 135° — M Diffused Dome 150° — L Diffused Dome 150° 	<ul style="list-style-type: none"> — Variable pixel pitch and number of dots per string — Up to 4m pixel pitch — Maximum 80 dots per string — Available in RGB, RGBW, White and DW — Two different versions: clear or diffused — Auto addressing — Easy installation and maintenance — Suitable for coastal applications — Real-time Status and temperature information via RDM

IP66 COAST 30 VOLT DC DMX 512 E-PIX

Product	Colour	Optic	Key Features
ARCHISHAPE® Dot S: Direct Ø53x43x18 mm M: Direct Ø60x68x14 mm L: Direct Ø70.7x55x14 mm S: Diffused Ø53x43x27 mm M: Diffused Ø67.7x52x14 mm L: Diffused Ø70.7x55x14 mm	— RGB — RGBW (W:6500K)	<ul style="list-style-type: none"> — Direct View 110° — Diffused Dome 150° 	<ul style="list-style-type: none"> — Fully customizable, IP67 — Variable pixel pitch and number of dots per string — Up to 2 m pixel pitch — Maximum 80 dots per string — One-click auto addressing via e:cue control system — Cost-effective solution for large scale installation

IP66 15 24 VOLTS DC DMX 512



ProPoint Vista

Super high brightness, long throw luminaire family.



The ProPoint Vista 100W/200W/400W series are a family of AC line powered, super high brightness luminaires. Delivering best in class output with a minimal fixture footprint. Controllable via DMX512 with built in Remote Device Management (RDM), Vista comes with precise control and monitoring capability over the entire system. The system is connected using a daisy chain topology with separate power and data cables for easy and cost efficient installation.

The ProPoint Vista has 100W/200W/400W power outputs, each head is individually addressed and controlled. A complete portfolio including RGBW, White (3000K, 4000K) as standard, Each luminaire features industry leading 3° native optics with an integrated internal louver as standard, eleven light shaping optics are available via a field installable spread lens module. Other accessories include full and half glare shields, rock guard and pole mounts.



- Key Features**
- Universal Input Voltage:120-277vAC
 - IP66 and suitable for coastal environments— Available in 3° native optic
 - DMX RDM Controlled
 - Auto Addressing
 - Available in 3 Standard Finishes: Traxon Grey, Black, & White
 - Each head can be controlled separately

- Colour Options**
- RGBW (W:4000K)
 - RGB
 - 3000K
 - 4000K

- Beam Options**
- 11 light shaping beam spreaders available as optional accessories
 - 3° Standard
 - 5°
 - 8°
 - 10°
 - 15°
 - 20°
 - 30°
 - 40°
 - 55°
 - 80°
 - 50° x 5°, 50° x 10°

Illumination

Product	Colour	Optic	Key Features
 <p>Allegro Linear 2.1 12 LED: 320x50x86 mm 24 LED: 615x50x86 mm 36 LED: 915x50x86 mm 48 LED: 1215x50x86 mm</p>	<ul style="list-style-type: none"> RGBW (W: 3000K) RGB Dynamic White (2700- 6500K) 3000K White 4000K White 6500K White 	<ul style="list-style-type: none"> 10° 40° 60°x10° 60°x30° 	<ul style="list-style-type: none"> Universal Input Voltage: 120-277vAC IP66 and suitable for Coastal Environments DynaMood® Technologies Active temperature monitoring Remote Device Management for full control Easy daisy-chain IN/OUT connectors

1200mm



900mm



600mm



300mm

Product	Colour	Optic	Key Features
 <p>ARCHISHAPE® Linear Mini 300mm / 500mm / 1000mm Midi 300mm / 500mm / 1000mm Maxi 300mm / 500mm / 1000mm Power 300mm / 500mm / 1000mm</p>	<ul style="list-style-type: none"> RGBW (W: 4000K) RGB 3000K White 4000K White 	<ul style="list-style-type: none"> 10° 40° 60°x10° 60°x30° 	<ul style="list-style-type: none"> Compact size (POWER / MAXI) Slim size (MIDI / MINI) Dedicated optic design Even washing effect Optimized color mixing (POWER / MAXI / MIDI) Quick installation and reliable connection by self-locking water-proof connectors ON/OFF or DMX

Power

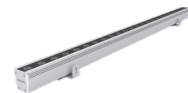

Maxi



Midi



Mini

Product	Colour	Optic	Key Features
 <p>Allegro Washer 2.0 50W: 235x317x203 mm 100W: 310x395x252 mm 150W: 392x476x264 mm 200W: 392x476x264 mm</p>	<ul style="list-style-type: none"> RGBW (W: 3000K) RGB Dynamic White (2700- 6500K) 3000K White 4000K White 6500K White 	<ul style="list-style-type: none"> 10° 60°x30° 60°x10° 55° 80° Via field installed spread lens 	<ul style="list-style-type: none"> Universal Input Voltage: 120-277vAC IP66 and suitable for Coastal Environments DynaMood® Technologies Active temperature monitoring Remote Device Management for full control 5° native optic for long throw applications Easy daisy-chain IN/OUT connectors

200W



150W



100W



50W

Product	Colour	Optic	Key Features
 <p>ARCHISHAPE® Washer 2.5 XS: 9W: 120x135x160 mm S: 18W: 200x219x262 mm S: 36W: 200x219x262 mm M: 54W: 275x297x349 mm M: 80W: 275x297x349 mm L: 150 W: 348x354x426 mm XL: 180 W: 398x415x475 mm</p>	<ul style="list-style-type: none"> RGBW (W:4000K) RGBW (W:4000K) 2700K White 3000K White 4000K White 	<ul style="list-style-type: none"> 10° 15° 30° 60° 	<ul style="list-style-type: none"> Auto Addressing Quick installation and reliable connection by self-locking waterproof connectors Versatile power range 9W - 180W Precise optics control RGBW for fine-tuned color XS / S 24V DC M / L / XL 230V AC

XL



L



M



S



XS

Illumination

Product	Colour	Optic	Key Features
 <p>ProPoint Washer 20W: 161x130x197 mm 40W: 222x165x254 mm 80W: 257x220x330 mm 120 W: 315x288x433 mm 180 W: 315x288x433 mm</p>	<ul style="list-style-type: none"> RGBW (W: 4000K) Dynamic White (2200-6500K) 3000K White 4000K White 	<ul style="list-style-type: none"> 8° 15° 25° 35° 	<ul style="list-style-type: none"> Product is available in 5 wattage outputs – 20W, 40W, 80W, 120W & 180W Available in 3 beam angles - 15°, 25° & 35° Controllable via DMX512 with Remote Device Management (RDM) Connected using a daisy chain topology, allowing easy installation to form long runs Available in 3 standard finishes Grey, Black & White Universal voltage – 120-277vAC IP66 Outdoor and Coastal rated Optics provide superior glare control/ glare cut-off

XL



M



S



XS

Product	Colour	Optic	Key Features
 <p>ProPoint Vista 100 1x100W: 649x286.8x144 mm 2x100W: 686x483x144 mm 3x100W: 694x710x144 mm</p>	<ul style="list-style-type: none"> RGBW (W:4000K) 3000K White 4000K White 	<ul style="list-style-type: none"> 3° Standard 5° 8° 10° 15° 20° 30° 40° 55° 80° 50° x 5° 50° x 10° Via field installed spread lens 	<ul style="list-style-type: none"> Universal Input Voltage: 120-277vAC IP66 and suitable for Coastal Environments Available in a native 3° optic Available in 3 Standard Finishes: Traxon Grey, Black, & White RDM controllable Optional accessories include: full glare shield, half glare shield, rock guard and pole mounts 11 light shaping optics are available via a field installable spread lens module

3 x 100W



2 x 100W



1 x 100W

Product	Colour	Optic	Key Features
 <p>ProPoint Vista 200 200W: 680x352x174 mm</p>	<ul style="list-style-type: none"> RGBW (W:4000K) 3000K White 4000K White 	<ul style="list-style-type: none"> 3° Standard 5° 8° 10° 15° 20° 30° 40° 55° 80° 50° x 5° 50° x 10° Via field installed spread lens 	<ul style="list-style-type: none"> Universal Input Voltage: 120-277vAC IP66 and suitable for Coastal Environments Available in a native 3° optic Available in 3 Standard Finishes: Traxon Grey, Black, & White RDM controllable Optional accessories include: full glare shield, half glare shield, rock guard and pole mounts 11 light shaping optics are available via a field installable spread lens module



Product	Colour	Optic	Key Features
 <p>ProPoint Vista 400 400W: 738x634x174 mm</p>	<ul style="list-style-type: none"> RGBW (W:4000K) 3000K White 4000K White 	<ul style="list-style-type: none"> 3° Standard 5° 8° 10° 15° 20° 30° 40°, 55°, 80° 50° x 5° 50° x 10° Via field installed spread lens 	<ul style="list-style-type: none"> Universal Input Voltage: 120-277vAC IP66 and suitable for Coastal Environments Available in a native 3° optic Available in 3 Standard Finishes: Traxon Grey, Black, & White RDM controllable Optional accessories include: full glare shield, half glare shield, rock guard and pole mounts 11 light shaping optics are available via a field installable spread lens module



How can we help you?

Technical Support:
support@ecue.com

General Information:
info.europe@traxontechnologies.com

Download our Mobile App



Connect with us on Social Media



OSRAM GmbH

Head office:
Marcel-Breuer-Strasse 6
80807 Munich, Germany
Phone +49 89 6213-0
Fax +49 89 6213-2020
www.osram.com

Traxon e:cue

Karl-Schurz-Straße 38
33100 Paderborn, Germany
Phone +49 5251 54648-0
Email info.europe@traxontechnologies.com
www.ecue.com
www.traxontechnologies.com

Our brands

