

Lateral Plungers· smooth, with seal - INCH

2B150.0180



Product Description

To be used for positioning and applying pressure, e.g. during painting and sandblasting. Sealed against chips and dirt.

Material

Seal

- CR

Body

- Aluminium

Spring

- Stainless steel

Pin

- Thermoplastic POM, white

Assembly

Installation by pressing in.

Formula for calculating the center distance for the mounting hole:

$$l_0 = z/2 + w + x,$$

l_0 = center distance,

y = workpiece height,

w = workpiece length,

x = coordinate dimension,

s = stroke,

z = stop diameter

Calculation dimension x :

y greater than or equal to $l_2 - d_2/2$, then $x =$

$$d_2/2 - s$$

or

y smaller than $l_2 - d_2/2$, then $x =$

$$d_2/2 - s - [(l_2 - d_2/2 - y) * 0,123]$$

Characteristic

Light spring load = spring from stainless steel

More information

Further products

- Eccentric Mounting Bushings, for lateral plungers, smooth - INCH

Drawing

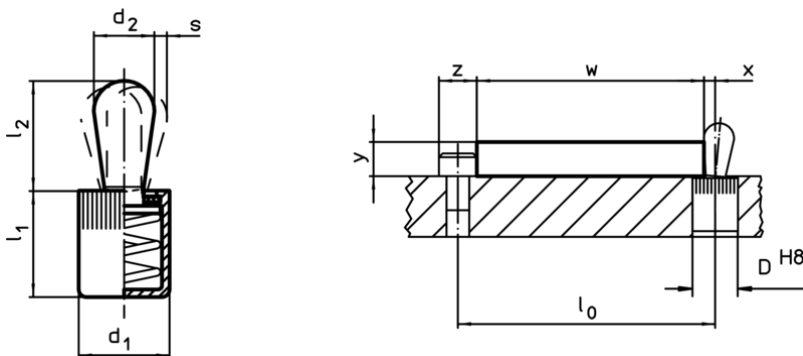

Order information

Dimensions		Spring load F max. ¹⁾ ~ [lb]	Dimensions		Stroke s [inch]	Location hole D H8 [inch]	max. [°F]	oz	Art. No.
d ₁	d ₂		l ₁	l ₂					
[inch]	[inch]		[inch]	[inch]					
5/8	0,393	22,5	0,708	0,646	0,12	5/8	176	0,299	2B150.0180

¹⁾ statistical average value

Accessories

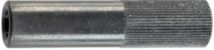
	Dimensions d ₁ [inch]	 [oz]	Art. No.
assembly tool			
	5/8	3,749	22150.0833

Application example

