

Rubber Metal Buffers

25150.0028



Product Description

To be used for elastic bearing of motors, compressors, pumps etc.
The hardness is $55 \pm 5^\circ$ shore A. Further shore hardnesses ($40 \pm 5^\circ$ shore A and $70 \pm 5^\circ$ shore A) on request.

Material

Support washer

- Steel, zinc-plated, blue chromated

Threaded bushing

- Steel, zinc-plated, blue chromated

Body

- Natural rubber (caoutchouc NR), black

Screw

- Steel, zinc-plated, blue chromated

Drawing

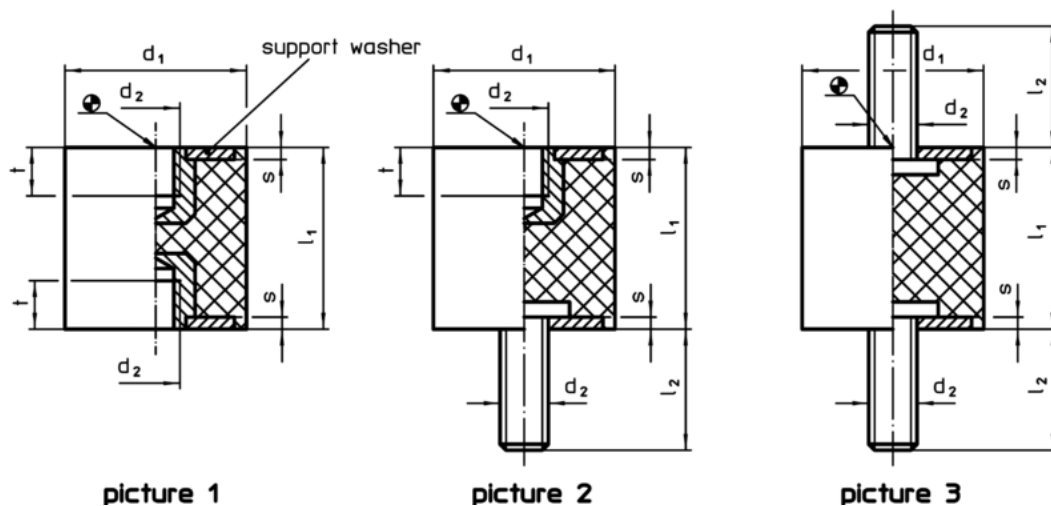

Order information

Dimensions					Spring rate R	Load capacity max.	Spring range	Temperature		Weight	Art. No.
d_1	l_1	d_2	s	t	~		~	min.	max.	[g]	
$\pm 1,5$	$\pm 1,5$			min.	[N/mm]	[N]	[mm]	[°C]			
with female thread on both sides – picture 1											
25	30	M6	2	5	77	575	7,5	-30	80	30	25150.0028

Application example

