

Knurled Thumb Screws • Plastic

24830.0070

Product Description



Material

Handle

- Thermoplastic PA, black

Screw

- Steel, zinc-plated by galvanization

Drawing

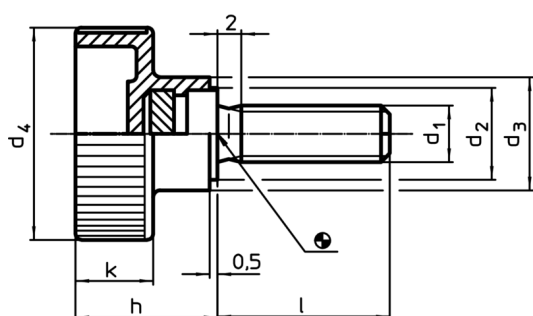

Order information

Dimensions							Temperature		Weight	Art. No.
d ₁	l	d ₂	d ₃	d ₄	h	k	min.	max.	[g]	
[mm]							[°C]			
Steel										
M10	20	16	18	36	22,5	12,5	-30	80	30	24830.0070

Application example

