

**Palm Grips** • DIN 6335 cast iron  
24620.0080



**Product Description**

Sandblasted or tumbled.

**Material**

**Handle**

- Grey cast iron GG 20, bright

**More information**

**Notes**

Grips with different bores or surface treatment can be obtained on request.

**Drawing**

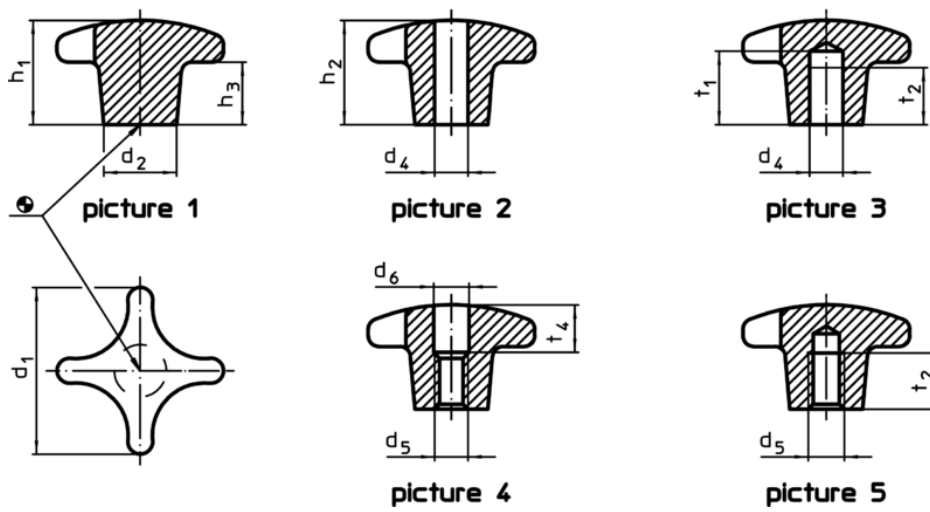

**Order information**

d <sub>1</sub>	Dimensions				[g]	Art. No.
	d <sub>2</sub>	h <sub>1</sub>	h <sub>3</sub>	[mm]		
raw part, form A – picture 1						
80	25	52	30		415	24620.0080