

Tommy Nuts· DIN 6307 with moveable pin

24510.0716



Product Description

With this version, the pin is moveable and held by the spring.

Material

- Free cutting steel, blackened

Drawing

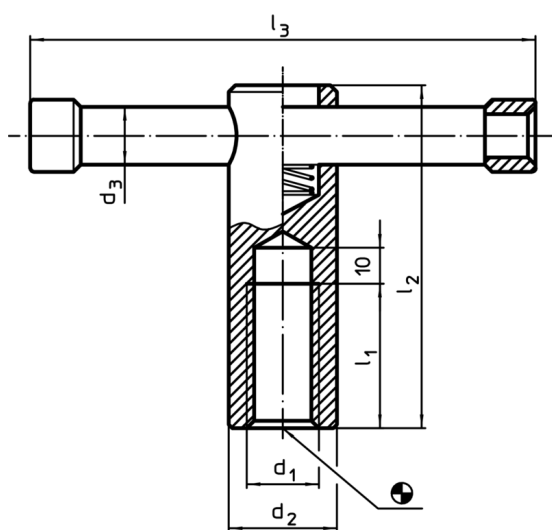

Order information

d ₁	d ₂	d ₃	Dimensions			[g]	Art. No.
			l ₁	l ₂	l ₃		
M16	24	13	35	85	120	327	24510.0716

Application example

